

LWU420

User Manual-Operating Guide

020-000262-01

CHRISTIE[®]

LWU420 User Manual-Operating Guide

User's Manual (detailed) – Operating Guide

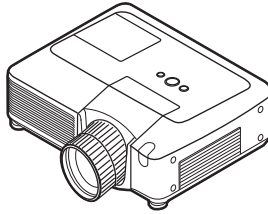

Thank you for purchasing this projector.

⚠ WARNING ▶ Before using this product, please read the "User's Manual - Safety Guide" and related manuals to ensure the proper use of this product. After reading them, store them in a safe place for future reference.

About this manual

Various symbols are used in this manual. The meanings of these symbols are described below.

- ⚠ WARNING** This symbol indicates information that, if ignored, could possibly result in personal injury or even death due to incorrect handling.
- ⚠ CAUTION** This symbol indicates information that, if ignored, could possibly result in personal injury or physical damage due to incorrect handling.

 Please refer to the pages written following this symbol.

NOTE • The information in this manual is subject to change without notice.
• The manufacturer assumes no responsibility for any errors that may appear in this manual.
• The reproduction, transfer or copy of all or any part of this document is not permitted without express written consent.

Trademark acknowledgment

- Microsoft and Internet Explorer, Windows, Windows NT, Windows Me, Windows Vista are registered trademark of Microsoft Corporation.
- PowerPC is a registered trademark of International Business Machines Corporation.
- VESA and DDC are trademarks of the Video Electronics Standard Association.
- Apple and Macintosh, Mac, Mac OS are registered trademarks of Apple Inc.
- Pentium is a registered trademark of Intel Corporation.
- JavaScript is a registered trademark of Sun Microsystems, Inc.
- DVI is a trademark of Digital Display Working Group.
- HDMI, the HDMI logo, and High-Definition Multimedia Interface are trademarks or registered trademarks of HDMI Licensing LLC in the United States and other countries.
- Blu-ray Disc is a trademark.

All other trademarks are the properties of their respective owners.

Contents



| | | |
|---|-----------|---|
| About this manual | 1 | (EASY MENU continued 28) |
| Contents | 2 | COLOR, TINT, SHARPNESS, WHISPER, |
| Projector features | 3 | MIRROR, RESET, FILTER TIME, |
| Preparations | 3 | LANGUAGE, Go to Advanced Menu... |
| Contents of package | 3 | PICTURE Menu 29 |
| Lens cover attachment and removal | 3 | BRIGHTNESS, CONTRAST, GAMMA, COLOR TEMP, |
| Part names | 4 | COLOR, TINT, SHARPNESS, ACTIVE IRIS, MY MEMORY |
| Projector | 4 | IMAGE Menu 32 |
| Control panel | 5 | ASPECT, OVER SCAN, V POSITION, H POSITION, |
| Rear panel | 5 | H PHASE, H SIZE, AUTO ADJUST EXECUTE |
| Remote control | 6 | INPUT Menu 34 |
| Setting up | 7 | PROGRESSIVE, VIDEO NR, 3D-YCS, |
| Arrangement | 8 | COLOR SPACE, COMPONENT, VIDEO FORMAT, |
| Adjusting the projector's elevator | 9 | HDMI, FRAME LOCK, RGB IN, RESOLUTION |
| Using the security bar and slot | 9 | SETUP Menu 38 |
| Connecting your devices | 10 | AUTO KEYSTONE [] EXECUTE, KEYSTONE [], |
| Connecting power supply | 12 | KEYSTONE [], PERFECT FIT, WHISPER, |
| Remote control | 13 | MIRROR, MONITOR OUT |
| Laser pointer | 13 | AUDIO Menu 41 |
| Installing the batteries | 13 | VOLUME, TREBLE, BASS, SPEAKER, |
| About the remote control signal | 14 | AUDIO, HDMI AUDIO |
| Changing the frequency of remote control signal | 14 | SCREEN Menu 42 |
| Using as a wired remote control | 15 | LANGUAGE, MENU POSITION, BLANK, |
| Using as a simple PC mouse & keyboard | 15 | START UP, My Screen, My Screen Lock, |
| Power on/off | 17 | MESSAGE, SOURCE NAME, TEMPLATE |
| Turning on the power | 17 | OPTION Menu 47 |
| Turning off the power | 17 | AUTO SEARCH, AUTO KEYSTONE [], |
| Operating | 18 | AUTO ON, AUTO OFF, LAMP TIME, |
| Adjusting the volume | 18 | FILTER TIME, MY BUTTON, MY SOURCE, |
| Temporarily muting the sound | 18 | SERVICE, SECURITY |
| Selecting an input signal | 18 | NETWORK Menu 60 |
| Searching an input signal | 19 | SETUP, PROJECTOR NAME, MY IMAGE, |
| Selecting an aspect ratio | 19 | INFORMATION, SERVICE |
| Adjusting the zoom and focus | 20 | C.C. (Closed Caption) Menu 65 |
| Adjusting the lens shift | 20 | DISPLAY, MODE, CHANNEL |
| Using the automatic adjustment feature | 20 | Maintenance 66 |
| Adjusting the position | 21 | Lamp 66 |
| Correcting distortion | 21 | Air filter 68 |
| Using the magnify feature | 23 | Internal clock battery 69 |
| Freezing the screen | 23 | Other care 70 |
| Temporarily blanking the screen | 24 | Troubleshooting 71 |
| PbyP (Picture by Picture) | 25 | Related messages 71 |
| Using the menu function | 26 | Regarding the indicator lamps 72 |
| EASY MENU | 27 | Phenomena that may be easy |
| ASPECT, AUTO KEYSTONE [] EXECUTE, | | to be mistaken for machine defects 74 |
| KEYSTONE [], KEYSTONE [], PERFECT FIT, | | Warranty and after-service 77 |
| PICTURE MODE, BRIGHTNESS, CONTRAST, | | Specifications 77 |

Projector features

This projector has a capability to project various picture signals onto a screen. This projector requires only a minimal amount of space for installation and can produce a large projected image from even a short distance. Moreover, the projector has the following features to extend its potentiality for broad use.

- ✓ The WUXGA (1920x1200) native resolution can support Widescreen PCs to realize your original images on a screen.
- ✓ The **HDMI** port can support various image equipment which have digital interface to get clearer pictures on a screen.

Preparations

Contents of package

Please see the “Contents of package” in the “User’s Manual (concise)” which is a book. Your projector should come with the items shown there. Contact immediately your dealer if anything is missing.

NOTE • Keep the original packing materials for future reshipment. Be sure to use the original packing materials when moving the projector. Use special caution for the lens.

Lens cover attachment and removal

- Remove lens cover before using the projector.
- Attach the lens cover as shown in the figure when the projector is not in use.

⚠ WARNING ▶ If the projector is bumped against a wall or other object without the lens cover in place, the projector could malfunction.

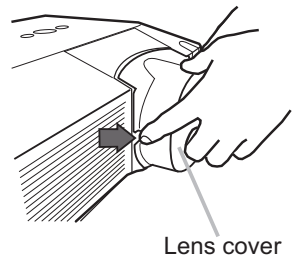
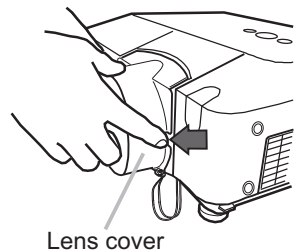

Part names

Projector

- (1) Speakers (x 2) (📖41)
- (2) Focus ring (📖20)
- (3) Zoom ring (📖20)
- (4) Lamp cover (📖66)
- (5) Lens shift cover (📖20)
- (6) Horizontal lens shift dial (📖20)
- (7) Vertical lens shift dial (📖20)
- (8) Control panel (📖5)
- (9) Lens (📖70)
- (10) Lens cover (📖3)
- (11) Remote sensors (x 3) (📖14)
- (12) Elevator feet (x 2) (📖9)
- (13) Elevator knobs (x 2) (📖9)
- (14) Filter cover (📖68)

The lamp unit is inside.

(14) Filter cover (📖68)
The air filter and intake vent are inside.

- (15) Exhaust vents
- (16) Intake vents
- (17) Handle
- (18) Battery cover (📖69)
- (19) Rear panel (📖5)

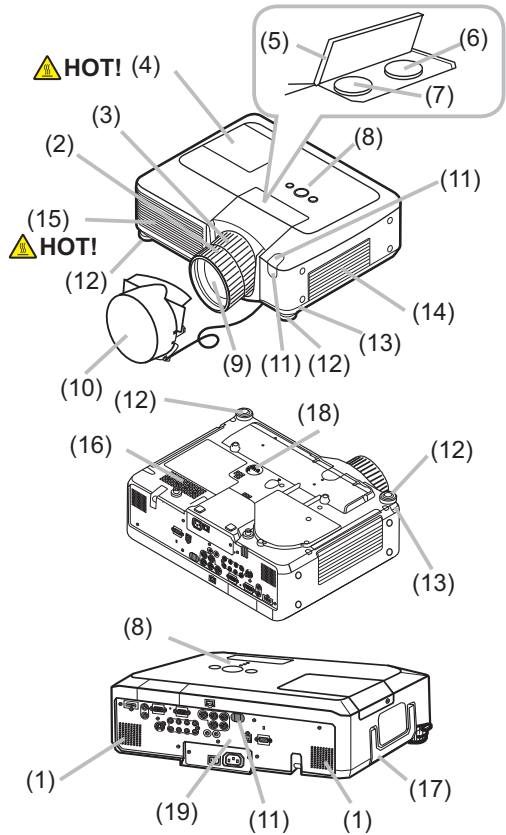

⚠ WARNING ▶HOT! : Do not touch around the lamp cover and the exhaust vents during use or just after use, since it is too hot.

- ▶ Do not look into the lens or vents while the lamp is on, since the strong light is not good for your eyes.
- ▶ Do not grab the front cover to hold the projector up, since the projector may drop down.
- ▶ Do not handle the elevator knobs without holding the projector, since the projector may drop down.

⚠ CAUTION ▶ Maintain normal ventilation to prevent the projector from heating up. Do not cover, block or plug up the vents. Do not place anything that can stick or be sucked to the vents, around the intake vents. Clean the air filter periodically.

Control panel

- (1) **STANDBY/ON** button (📖17)
- (2) **MENU** button (📖26)
It consists of four cursor buttons.
- (3) **INPUT** button (📖18)
- (4) **POWER** indicator (📖17, 72)
- (5) **TEMP** indicator (📖72)
- (6) **LAMP** indicator (📖72)

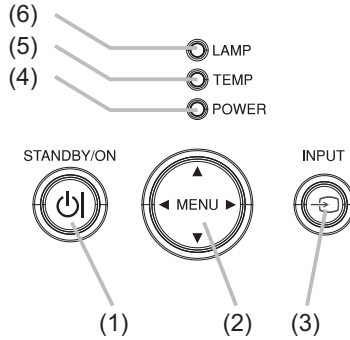

Rear panel

- (1) Shutdown switch (📖74)
- (2) Security slot (📖9)
- (3) Security bar (📖9)
- (4) **AC IN** (AC inlet) (📖12)
- (5) Power switch (📖17)
- (6) **RGB1** port (📖10)
- (7) **RGB2(G/Y, B/CB/PB, R/CR/PR, H, V)** port (📖10)
- (8) **CONTROL** port (📖10)
- (9) **HDMI** port (📖10)
- (10) **VIDEO** port (📖10)
- (11) **S-VIDEO** port (📖10)
- (12) **COMPONENT (Y, C_B/P_B, C_R/P_R)** ports (📖10)
- (13) **AUDIO IN1** port (📖10)
- (14) **AUDIO IN2** port (📖10)
- (15) **AUDIO IN3 (R/L)** ports (📖10)
- (16) **AUDIO IN4 (R/L)** ports (📖10)
- (17) **RGB OUT** port (📖10)
- (18) **AUDIO OUT** port (📖10)
- (19) **REMOTE CONTROL** port (📖10)
- (20) **LAN** port (📖10)
- (21) **USB** port (📖10)

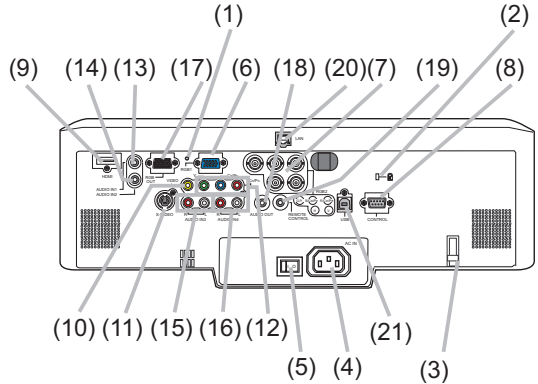

⚠ WARNING ▶ Do not use the security bar and the security slot to prevent the projector from falling down, since it is not designed for it.

⚠ CAUTION ▶ Use the shutdown switch only when the projector is not turned off by normal procedure, since pushing this switch stops operation of the projector without cooling it down.

Remote control

- (1) Laser pointer (13)
It is a beam outlet.
- (2) **LASER INDICATOR** (13)
- (3) **LASER** button (13)
- (4) **STANDBY/ON** button (17)
- (5) **VOLUME+/-** buttons (18)
- (6) **MUTE** button (18)
- (7) **VIDEO** button (19)
- (8) **RGB** button (18)
- (9) **SEARCH** button (19)
- (10) **AUTO** button (20)
- (11) **ASPECT** button (19)
- (12) **POSITION** button (19)
- (13) **KEystone** button (21)
- (14) **MY SOURCE/DOC.CAMERA** button (19)
- (15) **MAGNIFY - ON/- OFF** buttons (23)
- (16) **FREEZE** button (23)
- (17) **BLANK** button (24)
- (18) **MY BUTTON - 1** button (49)
- (19) **MY BUTTON - 2** button (49)
- (20) **MENU** button (26)
- (21) Lever switch (26) : acting 3 functions as below.
Cursor button ▲ : to slide toward the side marked ▲ .
Cursor button ▼ : to slide toward the side marked ▼ .
ENTER button : to push down the center point.
- (22) Cursor buttons ◀/▶ (26)
- (23) **PbyP** button (25)
- (24) **RESET** button (26)
- (25) **ESC** button (26)
- (26) Mouse left button (15)
- (27) Mouse right button (15)
- (28) **PAGE UP** button (15)
- (29) **PAGE DOWN** button (15)
- (30) Wired remote control port (15)
- (31) Battery cover (13)
- (32) Battery holder (13)
- (33) Frequency switch (14)

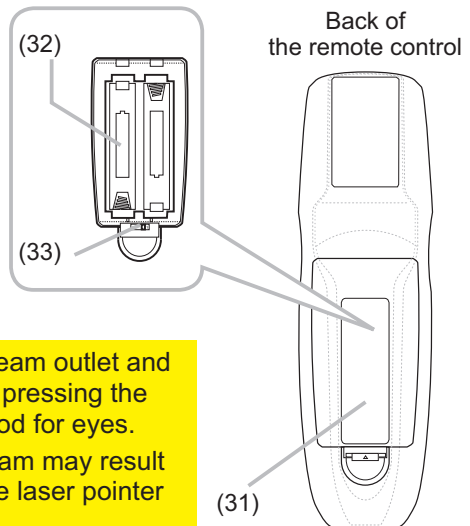
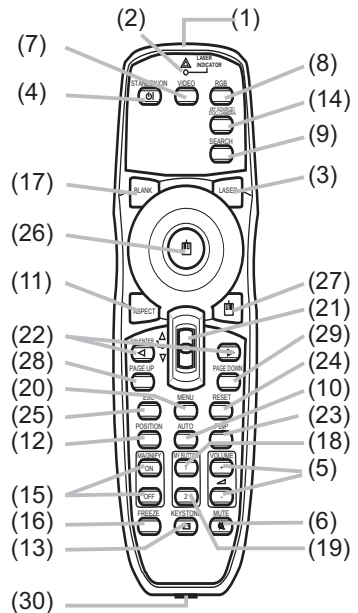

⚠ WARNING ▶ Do not look into the beam outlet and point the beam at people and pets while pressing the **LASER** button, since the beam is not good for eyes.

⚠ CAUTION ▶ Note that the laser beam may result in hazardous radiation exposure. Use the laser pointer only for pointing on the screen.

Setting up

Install the projector according to the environment and manner the projector will be used in.

⚠ WARNING ► Place the projector in a stable horizontal position. If the projector falls or is knocked over, it could cause injury and/or damage to the projector. Using a damaged projector could then result in fire and/or electric shock.

- Do not place the projector on an unstable, slanted or vibrational surface such as a wobbly or inclined stand.
- Do not place the projector on its side, front or rear position.
- Consult with your dealer before a special installation such as suspending from a ceiling.
- Place the projector in a cool place, and ensure that there is sufficient ventilation. The high temperature of the projector could cause fire, burns and/or malfunction of the projector.
- Do not place or attach anything that would block the lens or vent holes.
- Keep a space of 30 cm or more between the sides of the projector and other objects such as walls.
- Do not place the projector on metallic thing or anything weak in heat.
- Do not place the projector on carpet, cushions or bedding.
- Do not place the projector in direct sunlight or near hot objects such as heaters.
- Do not place anything near the projector lens or vents, or on top of the projector.
- Do not place anything that may be sucked into or stick to the vents on the bottom of the projector. This projector has some intake vents also on the bottom.
- Do not place the projector anyplace where it may get wet. Getting the projector wet or inserting liquid into the projector could cause fire, electric shock and/or malfunction of the projector.
- Do not place the projector in a bathroom or the outdoors.
- Do not place anything containing liquid near the projector.
- Do not place the projector where any oils, such as cooking or machine oil, are used.

⚠ CAUTION ► Avoid placing the projector in smoky, humid or dusty place. Placing the projector in such places could cause fire, electric shock and/or malfunction of the projector.

- Do not place the projector near humidifiers, smoking spaces or a kitchen. Also do not use an ultrasonic humidifier near the projector. Otherwise chlorine and minerals contained in tap water are atomized and could be deposited in the projector causing image degradation or other problems.
- Position the projector to prevent light from directly hitting the projector's remote sensor.

Arrangement

Refer to the illustrations and tables below to determine screen size and projection distance.

The values shown in the table are calculated for a full size screen: 1920×1200

(a) Screen size (diagonal)

(b) Projection distance (±10%)

(c) Screen height (±10%), when the vertical lens shift () is set full upward.

On a horizontal surface

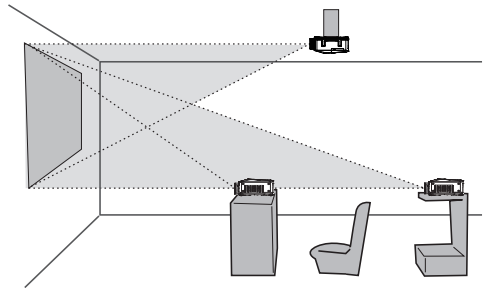
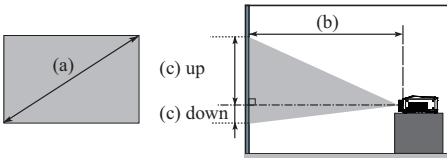

Suspended from the ceiling

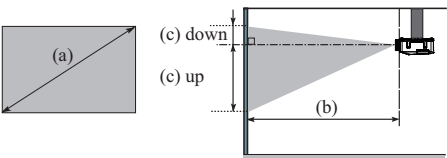

- Keep a space of 30 cm or more between the sides of the projector and other objects such as walls.
- Consult with your dealer before a special installation such as suspending from a ceiling.

| (a) Screen size [inch (m)] | 16:10 screen | | | | 4:3 screen | | | |
|-------------------------------|---------------------------------------|------------|----------------------------------|-----------|---------------------------------------|------------|----------------------------------|-----------|
| | (b) Projection distance [m (inch)] | | (c) Screen height [cm (inch)] | | (b) Projection distance [m (inch)] | | (c) Screen height [cm (inch)] | |
| | min. | max. | down | up | min. | max. | down | up |
| 30 (0.8) | 0.9 (37) | 1.9 (75) | 0 (0) | 40 (16) | 1.1 (42) | 2.1 (84) | 0 (0) | 46 (18) |
| 40 (1.0) | 1.3 (49) | 2.5 (100) | 0 (0) | 54 (21) | 1.4 (56) | 2.9 (113) | 0 (0) | 61 (24) |
| 60 (1.5) | 1.9 (75) | 3.8 (150) | 0 (0) | 81 (32) | 2.2 (85) | 4.3 (170) | 0 (0) | 91 (36) |
| 70 (1.8) | 2.2 (87) | 4.4 (175) | 0 (0) | 94 (37) | 2.5 (99) | 5.0 (198) | 0 (0) | 107 (42) |
| 80 (2.0) | 2.5 (100) | 5.1 (200) | 0 (0) | 108 (42) | 2.9 (113) | 5.8 (227) | 0 (0) | 122 (48) |
| 90 (2.3) | 2.9 (113) | 5.7 (225) | 0 (0) | 121 (48) | 3.2 (128) | 6.5 (255) | 0 (0) | 137 (54) |
| 100 (2.5) | 3.2 (125) | 6.4 (250) | 0 (0) | 135 (53) | 3.6 (142) | 7.2 (283) | 0 (0) | 152 (60) |
| 120 (3.0) | 3.8 (150) | 7.6 (300) | 0 (0) | 162 (64) | 4.3 (170) | 8.6 (340) | 0 (0) | 183 (72) |
| 150 (3.8) | 4.8 (188) | 9.5 (376) | 0 (0) | 202 (79) | 5.4 (213) | 10.8 (426) | 0 (0) | 229 (90) |
| 200 (5.1) | 6.4 (252) | 12.7 (501) | 0 (0) | 269 (106) | 7.2 (285) | 14.4 (568) | 0 (0) | 305 (120) |
| 250 (6.4) | 8.0 (315) | 15.9 (627) | 0 (0) | 337 (132) | 9.1 (356) | 18.0 (710) | 0 (0) | 381 (150) |
| 300 (7.6) | 9.6 (378) | 19.1 (752) | 0 (0) | 404 (159) | 10.9 (428) | 21.6 (852) | 0 (0) | 457 (180) |
| 350 (8.9) | 11.2 (441) | 22.3 (878) | 0 (0) | 471 (185) | 12.7 (499) | 25.2 (994) | 0 (0) | 533 (210) |

Adjusting the projector's elevator

When the place to put the projector is slightly uneven to the left or right, use the elevator feet to place the projector horizontally.

Using the feet can also tilt the projector in order to project at a suitable angle to the screen, elevating the front side of the projector within 10 degrees.

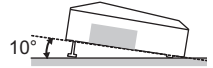

This projector has 2 elevator feet and 2 elevator knobs. An elevator foot is adjustable while pulling up the elevator knob on the same side as it.

1. Holding the projector, pull the elevator knobs up to loose the elevator feet.
2. Position the front side of the projector to the desired height.
3. Release the elevator knobs in order to lock the elevator feet.
4. After making sure that the elevator feet are locked, put the projector down gently.
5. If necessary, the elevator feet can be manually twisted to make more precise adjustments. Hold the projector when twisting the feet.

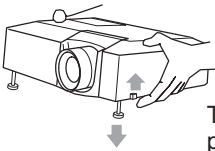

To loose an elevator foot, pull up the elevator knob on the same side as it.

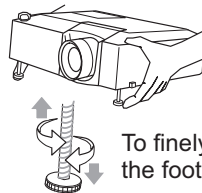

To finely adjust, twist the foot.

⚠ CAUTION ▶ Do not handle the elevator knobs without holding the projector, since the projector may drop down.
 ▶ Do not tilt the projector other than elevating its front within 10 degrees using the adjuster feet. A tilt of the projector exceeding the restriction could cause malfunction or shortening the lifetime of consumables, or the projector itself.

Using the security bar and slot

A commercial anti-theft chain or wire up to 10 mm in diameter can be attached to the security bar on the projector. Also this product has the security slot for the Kensington lock. For details, see the manual of the security tool.

⚠ WARNING ▶ Do not use the security bar and the security slot to prevent the projector from falling down, since it is not designed for it.

NOTE • The security bar and the security slot are not comprehensive theft prevention measures. They are intended to be used as supplemental theft prevention measure.

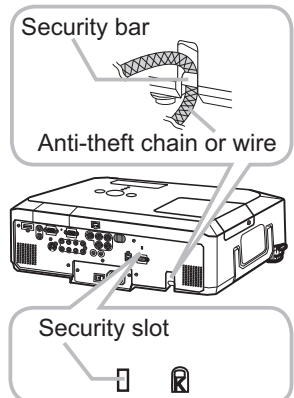

Connecting your devices

Be sure to read the manuals for devices before connecting them to the projector. Make sure that all the devices are suitable to be connected with this product, and prepare the cables required to connect. Please refer to the following illustrations to connect them.

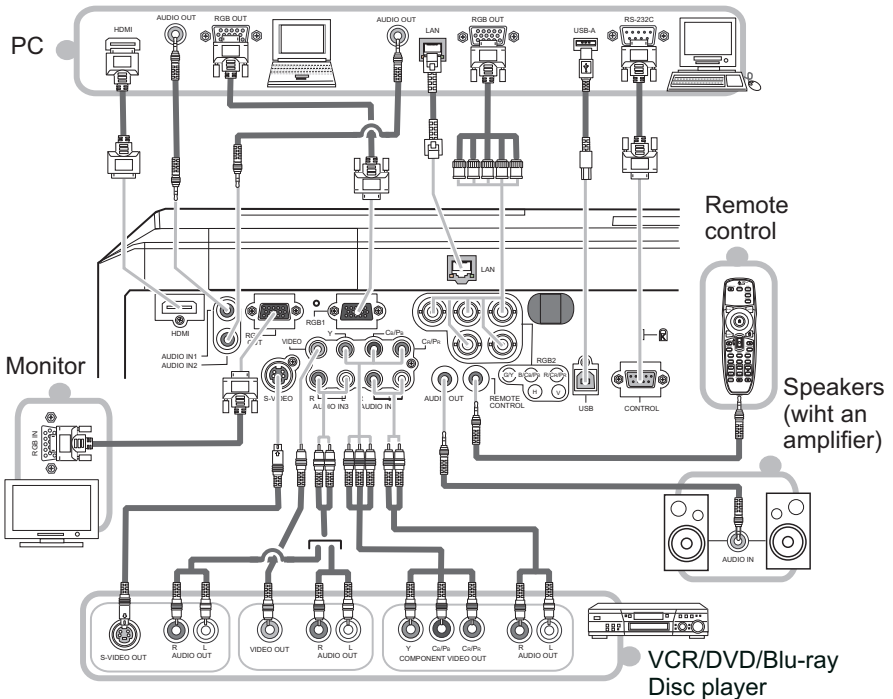

- ⚠ **WARNING** ▶ Do not disassemble or modify the projector.
- ▶ Be careful not to damage the cables, and do not use damaged cables.
- ⚠ **CAUTION** ▶ Turn off all devices and unplug their power cords prior to connecting them to projector. Connecting a live device to the projector may generate extremely loud noises or other abnormalities that may result in malfunction or damage to the device and the projector.
- ▶ Use appropriate accessory or designated cables. Ask your dealer about non-accessory cables which may be required a specific length or a ferrite core by the regulations. For cables with a core only at one end, connect the end with the core to the projector.
- ▶ Make sure that devices are connected to the correct ports. An incorrect connection may result in malfunction or damage to the device and the projector.

Connecting your devices (continued)

- NOTE** • Be sure to read the manuals for devices before connecting them to the projector, and make sure that all the devices are suitable to be connected with this product. Before connecting to a PC, check the signal level, the signal timing, and the resolution.
- Be sure to consult to the administrator of the network. Do not connect **LAN** port to any network that might have the excessive voltage.
 - Some signal may need an adapter to input this projector.
 - Some PCs have multiple screen display modes that may include some signals which are not supported by this projector.
 - Although the projector can display signals with resolution up to WUXGA (1920X1200), the signal will be converted to the projector's panel resolution before being displayed. The best display performance will be achieved if the resolutions of the input signal and the projector panel are identical.
 - While connecting, make sure that the shape of the cable's connector fits the port to connect with. And be sure to tighten the screws on connectors with screws.
 - When connecting a laptop PC to the projector, be sure to activate the PC's external RGB output. (Set the laptop PC to CRT display or to simultaneous LCD and CRT display.) For details on how this is done, please refer to the instruction manual of the corresponding laptop PC.
 - When the picture resolution is changed on a computer depending on an input, automatic adjustment function may take some time and may not be completed. In this case, you may not be able to see a check box to select "Yes/No" for the new resolution on Windows. Then the resolution will go back to the original. It might be recommended to use other CRT or LCD monitors to change the resolution.
 - In some cases, this projector may not display a proper picture or display any picture on screen. For example, automatic adjustment may not function correctly with some input signals. An input signal of composite sync or sync on G may confuse this projector, so the projector may not display a proper picture.
 - The **HDMI** port of this model is compatible with HDCP (High-bandwidth Digital Content Protection) and therefore capable of displaying a video signal from HDCP compatible DVD players or the like.

About Plug-and-Play capability

Plug-and-Play is a system composed of a computer, its operating system and peripheral equipment (i.e. display devices). This projector is VESA DDC 2B compatible. Plug-and-Play can be used by connecting this projector to a computer that is VESA DDC (display data channel) compatible.

- Take advantage of this feature by connecting an RGB cable to the **RGB1** port (DDC 2B compatible). Plug-and-Play may not work properly if any other type of connection is attempted.
- Please use the standard drivers in your computer as this projector is a Plug-and-Play monitor.

NOTE for HDMI

- The **HDMI** supports the following signals.
 - Video signal : 480i@60,480p@60,576i@50,720p@50/60,1080i@50/60,1080p@50/60
 - PC signals : See User's Manual (detailed) Technical
 - Audio signal : Format Linear PCM
Sampling Frequency 48kHz / 44.1kHz / 32kHz
- This projector can be connected with another equipment that has HDMI or DVI connector, but with some equipment the projector may not work properly, something like no video or no audio.
- Be sure to use an HDMI cable that has the HDMI logo.
- When the projector is connected with a device having DVI connector, use a DVI to HDMI cable to connect with the **HDMI** input and an audio cable to connect with one of the **AUDIO** input.

Connecting power supply

1. Connect the connector of the power cord to the **AC IN** (AC inlet) of the projector.
2. Firmly plug the power cord's plug into the outlet.

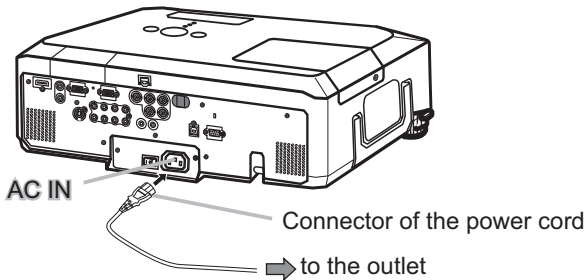

⚠ WARNING ► Please use extra caution when connecting the power cord, as incorrect or faulty connections may result in fire and/or electrical shock.

- Only use the power cord that came with the projector. If it is damaged, contact your dealer to get a new one.
- Only plug the power cord into an outlet whose voltage is matched to the power cord. The power outlet should be close to the projector and easily accessible. Remove the power cord for complete separation.
- Never modify the power cord.

Remote control

Laser pointer

This remote control has a laser pointer in place of a finger or rod. The laser beam works and the **LASER INDICATOR** lights while the **LASER** button is pressed.

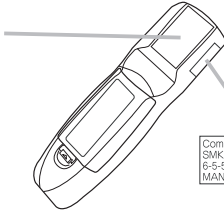

LASER INDICATOR

LASER button

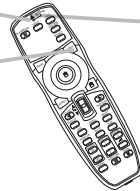

Complies with 21 CFR 1040.10 and 1040.11.
 ISMK CORPORATION
 6-5-5 Togoshi Shinagawa-ku, Tokyo, JAPAN 142-8511
 MANUFACTURED June 2002 PLACE OF MANUFACTURER : Δ

⚠ WARNING ▶ The laser pointer of the remote control is used in place of a finger or rod. Never look directly into the laser beam outlet or point the laser beam at other people. The laser beam can cause vision problems.

⚠ CAUTION ▶ Use of controls or adjustments or performance of procedures other than those specified herein may result in hazardous radiation exposure.

Installing the batteries

Please insert the batteries before using the remote control. If the remote control starts to malfunction, replace the batteries. If you will not use the remote control for an extended period, remove the batteries from the remote control and store them in a safe place.

1. Slide back and remove the battery cover in the direction of the arrow.
2. Align and insert the two AA batteries (**HITACHI MAXELL, Part No.LR6 or R6P**) according to their plus and minus terminals as indicated in the remote control.
3. Replace the battery cover in the direction of the arrow and snap it back into place.

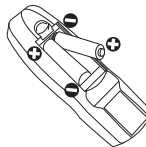
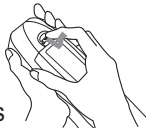

⚠ WARNING ▶ Always handle the batteries with care and use them only as directed. Improper use may result in battery explosion, cracking or leakage, which could result in fire, injury and/or pollution of the surrounding environment.

- Be sure to use only the batteries specified. Do not use batteries of different types at the same time. Do not mix a new battery with used one.
- Make sure the plus and minus terminals are correctly aligned when loading a battery.
- Keep a battery away from children and pets.
- Do not recharge, short circuit, solder or disassemble a battery.
- Do not place a battery in a fire or water. Keep batteries in a dark, cool and dry place.
- If you observe battery leakage, wipe out the leakage and then replace a battery.

If the leakage adheres to your body or clothes, rinse well with water immediately.

- Obey the local laws on disposing the battery.

About the remote control signal

The remote control works with the projector's remote sensors. This projector has three remote sensors on the front, on the top, and on the back.

The sensors can be respectively turned active or inactive using the "REMOTE RECEIV." in the SERVICE item of OPTION Menu (📖51). Each sensor senses the signal within the following range when the sensor is active.

The front and top sensors:

60 degrees (30 degrees to the left and right of the sensor) within 3 meters about.

The back sensor:

40 degrees (20 degrees to the left and right of the sensor) within 3 meters about.

NOTE • The remote control signal reflected in the screen or the like may be available. If it is difficult to send the signal to the sensor directly, attempt to make the signal reflect.

- The remote control uses infrared light to send signals to the projector (Class 1 LED), so be sure to use the remote control in an area free from obstacles that could block the remote control's signal to the projector.

- The remote control may not work correctly if strong light (such as direct sun light) or light from an extremely close range (such as from an inverter fluorescent lamp) shines on the remote sensor of the projector. Adjust the position of projector avoiding those lights.

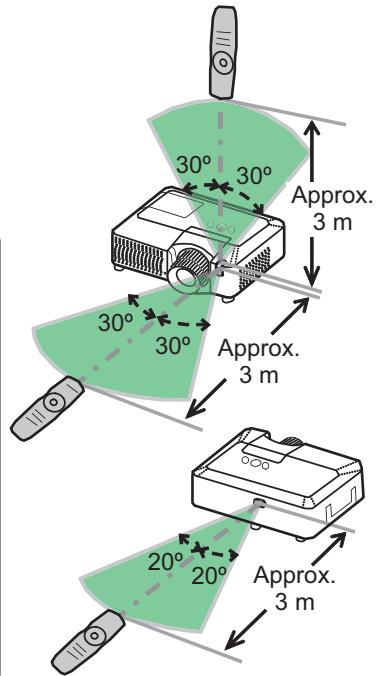

Changing the frequency of remote control signal

The accessory remote control has the choice of the mode 1 or the mode 2, in the frequency of its signal. If the remote control does not function properly, attempt to change the signal frequency. Please remember that the "REMOTE FREQ." in SERVICE item of OPTION Menu (📖51) of the projector to be controlled should be set to the same mode as the remote control.

To set the mode of the remote control, slide the knob of the frequency switch inside the battery cover into the position indicated by the mode number to choose.

Back of the remote control

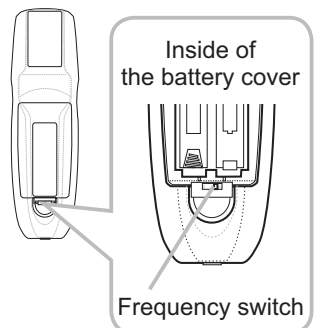

Using as a wired remote control

The accessory remote control works as a wired remote control, when the wired control port at the bottom of the remote control connects with the **REMOTE CONTROL** port on the back of the projector via an audio cable with 3.5 diameter stereo mini plugs.

When the remote control signal is hard to reach surely to the projector in the environment, this function is effective.

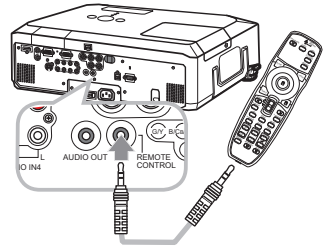

NOTE • To connect the remote control with the projector, use an audio cable with 3.5 diameter stereo mini plugs.

Using as a simple PC mouse & keyboard

The accessory remote control works as a simple mouse and keyboard of the PC, when the projector's **USB** port(B type) connect with the PC's USB port(A type) via a USB cable.

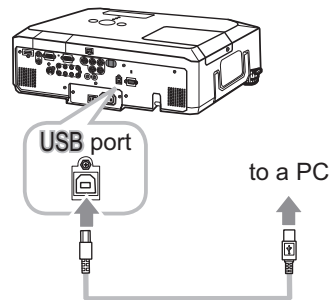

(1) Mouse left button

Pushing the button into the center point works instead of clicking the mouse's left button.
Tilting this button to one of eight directions moves the PC's move pointer on the screen in the direction.

(2) Mouse right button

Pressing the button works instead of clicking the mouse's right button.

(3) Lever switch

Sliding toward the side marked ▲ works instead of the [↑] key on the keyboard. Sliding toward the side marked ▼ works instead of the [↓] key on the keyboard.

(4) Cursor button ◀

This button works instead of the [←] key on the keyboard.

(5) Cursor button ▶

This button works instead of the [→] key on the keyboard.

(6) PAGE UP button

This button works instead of the PAGE UP key on the key board.

(7) PAGE DOWN button

This button works instead of the PAGE DOWN key on the key board.

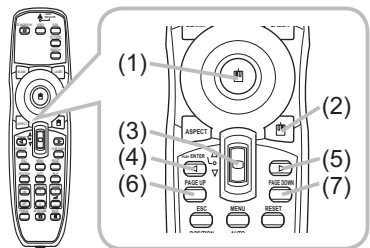

NOTE • When the simple mouse & keyboard function of this product does not work correctly, please check the following.

- When a USB cable connects this projector with a PC having a built-in pointing device (e.g. track ball) like a notebook PC, open BIOS setup menu, then select the external mouse and disable the built-in pointing device, because the built-in pointing device may have priority to this function.
- Windows 95 OSR 2.1 or higher is required for this function. And also this function may not work depending on the PC's configurations and mouse drivers.
- Operating simultaneously two or more keys is void except for mouse drag and drop operation.
- This function is activated only when the projector is working properly.

Using as a simple PC mouse & keyboard (continued)

- NOTE** • This function is not available in any of the following cases:
- While the lamp is warming up. (The **POWER** indicator blinks in green.)
 - While displaying BLANK (📄24), TEMPLATE (📄46) or MY IMAGE (📄63) screen.
 - When any menu is displayed on the screen.
 - While using the cursor buttons to operate the sound or screen functions such as adjusting the sound volume, correcting the keystone, correcting the picture position and magnifying the screen.
 - Improper use of the simple mouse & keyboard function could damage your equipment. While using this function, please connect this product only to a computer. Be sure to check your computer's manuals before connecting this product to the computer.

Power on/off

Turning on the power

1. Make sure that the power cord is firmly and correctly connected to the projector and the outlet.
2. Remove the lens cover, and set the power switch to the ON position (marked "I").
The **POWER** indicator will light up in steady orange (📖72). Then wait several seconds because the buttons may not function for these several seconds.
3. Press the **STANDBY/ON** button on the projector or the remote control.

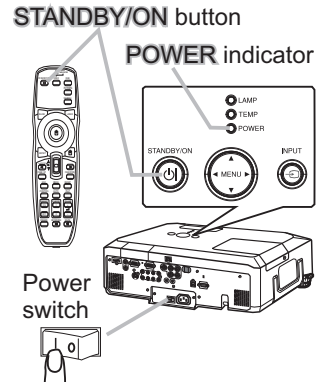

The projection lamp will light up and the **POWER** indicator will begin blinking in green. When the power is completely on, the indicator will stop blinking and light in steady green.

To display the picture, select an input signal according to the section "Selecting an input signal" (📖18, 19).

Turning off the power

1. Press the **STANDBY/ON** button on the projector or the remote control.
The message "Power off?" will appear on the screen for about 5 seconds.
2. Press the **STANDBY/ON** button on the projector or the remote control again while the message appears.
The projector lamp will go off, and the **POWER** indicator will begin blinking in orange. Then the **POWER** indicator will stop blinking and light in steady orange when the lamp cooling is complete.
3. Make sure that the **POWER** indicator lights in steady orange, and set the power switch to the OFF position (marked "O").
The **POWER** indicator will go off. Attach the lens cover.

Do not turn the projector on for 10 minutes or more after turning it off. Also, do not turn the projector off shortly after turning it on. Such operations might cause the lamp to malfunction or shorten the lifetime of some parts including the lamp.

⚠ WARNING ▶ A strong light is emitted when the projector's power is on. Do not look into the lens of the projector or look inside of the projector through any of the projector's openings.

▶ Do not touch around the lamp cover and the exhaust vents during use or just after use, since it is too hot.

NOTE • Turn the power on/off in right order. Please power on the projector prior to the connected devices. Power off the projector later than the connected devices.

- When the AUTO ON of the OPTION Menu is set to the TURN ON, and the power was turned off by the power switch last time, turning the power switch on makes the projection lamp light on without pushing the **STANDBY/ON** button (📖47).
- Use the shutdown switch (📖74) only when the projector is not turned off by normal procedure.

Operating

Adjusting the volume

- Use the **VOLUME + / VOLUME -** buttons to adjust the volume.
A dialog will appear on the screen to aid you in adjusting the volume. If you do not do anything, the dialog will automatically disappear after a few seconds.

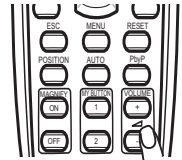

- When **X** is selected for current picture input port, the volume adjustment is disabled. Please see **AUDIO** item of **AUDIO Menu (41)**.
- When the projector is in the standby mode, the volume can be adjusted if **X** is not selected for the **AUDIO OUT STANDBY** of **AUDIO (41)**.

Temporarily muting the sound

- Press **MUTE** button on the remote control.
A dialog will appear on the screen indicating that you have muted the sound.
To restore the sound, press the **MUTE, VOLUME +** or **VOLUME -** button. Even if you do not do anything, the dialog will automatically disappear after a few seconds.



- When **X** is selected for current picture input port, the sound is always muted. Please see **AUDIO** item of **AUDIO Menu (41)**.
- When the sound is muted while a signal from **VIDEO(NTSC)**, **S-VIDEO(NTSC)** or **COMPONENT(480i@60)** port is selected, the **C.C.** (Closed Caption) is automatically activated if the **DISPLAY** item of the **C.C. Menu** is set to **AUTO** and the input signal supports the **C.C.** feature (**65**).

Selecting an input signal

- Press the **INPUT** button on the projector.
Each time you press the button, the projector switches its input from the current port as below.

→ RGB 1 → RGB 2 → HDMI →
 VIDEO ← S-VIDEO ← COMPONENT (Y, C_B/P_B, C_R/P_R) ←

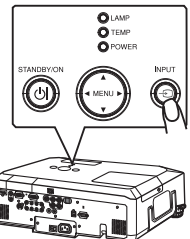

- Press the **RGB** button on the remote control to select an input port for the RGB signal.
Each time you press the button, the projector switches its RGB input from the current port as below.

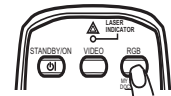

- While **TURN ON** is selected for **AUTO SEARCH** item in **OPTION Menu**, the projector will keep checking every port sequentially till an input signal is detected (**47**). If **RGB** button is pushed when **VIDEO, S-VIDEO** or **COMPONENT** port is selected, the projector will check **RGB1** port first.

(continued on next page)

Selecting an input signal (continued)

1. Press the **VIDEO** button on the remote control to select an input for video signal.

Each time you press the button, the projector switches its video input port as below.

COMPONENT (Y, C_B/P_B, C_R/P_R) → S-VIDEO → VIDEO

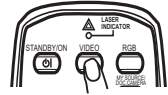

- While **TURN ON** is selected for **AUTO SEARCH** item in **OPTION** Menu, the projector will keep checking every port sequentially till an input signal is detected (47). If **VIDEO** button is pushed when **RGB 1** or **RGB 2** port is selected, the projector will check **COMPONENT** port first.

1. Press the **MY SOURCE / DOC. CAMERA** button on the remote control. The input signal will be changed into the signal you set as **MY SOURCE** (49).

- This function also can use for document camera. Select the input port that connected the document camera.

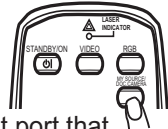

Searching an input signal

1. Press the **SEARCH** button on the remote control. The projector will start to check its input ports in order to find any input signals.

When an input is found, the projector will stop searching and display the image. If no signal is found, the projector will return to the state selected before the operation.

RGB 1 → RGB 2 → HDMI → COMPONENT (Y, C_B/P_B, C_R/P_R) → S-VIDEO → VIDEO

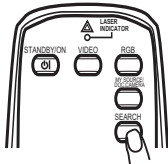

Selecting an aspect ratio

1. Press the **ASPECT** button on the remote control. Each time you press the button, the projector switches the mode for aspect ratio in turn.

- For an **RGB** signal

NORMAL → 4:3 → 16:9 → 16:10 → REAL

- For an **HDMI** signal

NORMAL → 4:3 → 16:9 → 16:10 → 14:9 → REAL

- For a **video signal, s-video signal or component video signal**

4:3 → 16:9 → 16:10 → 14:9 → REAL

- For **no signal**

16:10 (fixed)

- The **NORMAL** mode keeps the original aspect ratio of the signal.
- Some input signals may not be displayed in the aspect ratio as selected in the menu. In this case, use the **ASPECT** button on the remote control to select other aspect ratio.

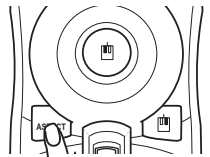

Adjusting the zoom and focus

1. Use the zoom ring to adjust the screen size.
2. Use the focus ring to focus the picture.

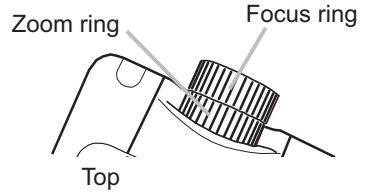

Adjusting the lens shift

1. Use the vertical lens shift dial to shift the picture upward or downward.
2. Use the horizontal lens shift dial to shift the picture left or right.

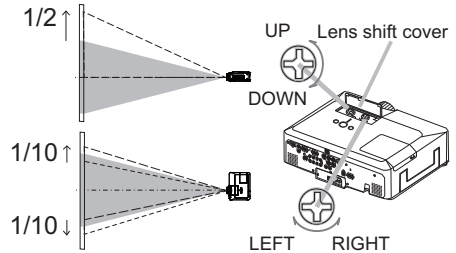

NOTE • When the vertical lens shift is adjusted, it is recommended to shift the picture upward.

Using the automatic adjustment feature

1. Press the **AUTO** button on the remote control.
 - Pressing this button performs the following.
 - **For an RGB signal**
The vertical position, the horizontal position and the horizontal phase will be automatically adjusted. Make sure that the application window is set to its maximum size prior to attempting to use this feature. A dark picture may still be incorrectly adjusted. Use a bright picture when adjusting.
 - **For a video signal and s-video signal**
The video format best suited for the respective input signal will be selected automatically. This function is available only when the AUTO is selected for the VIDEO FORMAT item in the INPUT Menu (📖35). The vertical position and horizontal position will be automatically set to the default.
 - **For a component video signal**
The vertical position, horizontal position and horizontal phase will be automatically set to the default.
 - The automatic adjustment operation requires approx. 10 seconds. Also please note that it may not function correctly with some input. When this function is performed for a video signal, a certain extra such as a line may appear outside a picture.
 - The items adjusted by this function may vary when the FINE or DISABLE is selected for the AUTO ADJUST item of the SERVICE item in the OPTION Menu (📖50).

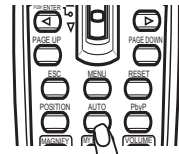

Adjusting the position

1. Press the **POSITION** button on the remote control when no menu is indicated.
The “POSITION” indication will appear on the screen.
2. Use the ▲/▼/◀/▶ cursor buttons to adjust the picture position.
When you want to reset the operation, press the **RESET** button on the remote control during the operation.
To complete this operation, press the **POSITION** button again. Even if you do not do anything, the dialog will automatically disappear after a few seconds.

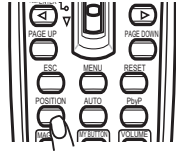

- When this function is performed on a video signal, s-video signal or component video signal, some image such as an extra-line may appear at outside of the picture.
- When this function is performing on a Video signal, S-Video signal, or component signal of 480i@60 or 576i@50 input the range of this adjustment depends on the OVER SCAN in IMAGE Menu (32). It is not possible to adjust when the OVER SCAN is set to 10.

Correcting distortion

1. Press the **KEYSTONE** button on the remote control. A dialog will appear on the screen to aid you in correcting the distortion. Even if you do not do anything, the dialog will automatically disappear after a few seconds.



2. Use the ▲/▼ cursor buttons to select AUTO, MANUAL or PERFECT FIT operation, and press the ► button to perform the following.
 - (1) AUTO executes automatic vertical keystone correction.
 - When V:INVERT or H&V:INVERT is selected to the MIRROR item in the SETUP Menu, if the projector screen is inclined or angled downward, this function may not work correctly.
 - When the zoom adjustment is set to the TELE (telephoto focus), this function may be excessive. This function should be used when the zoom adjustment is set to the full WIDE (wide-angle focus) whenever possible.
 - When the projector is placed on the level (about ±3°), this function may not work.
 - When the projector is inclined to near ±30 degree or over, this function may not work well.
 - When the vertical lens shift is not set fully upward, this function may not work well.
 - When the horizontal lens shift is not set to the center, this function may not work well.

Correcting distortion (continued)

- (2) MANUAL displays a dialog for keystone correction. Use the ◀/▶ cursor buttons to select the direction to correct (▤ or ◁) then use the ▲/▼ buttons for adjustment. Even if you do not do anything, the dialog will automatically disappear after a few seconds.
- (3) PERFECT FIT displays a dialog for the shape adjustment of the projected image in each of the corners.
 - 1) Choose the corner to adjust using the ▲/▼/◀/▶ buttons and press the **ENTER** or **INPUT** button.
 - 2) Use the ▲/▼/◀/▶ buttons to adjust the position of the corner. Press the **ENTER** or **INPUT** button to exit the adjustment of the corner.
 - 3) To adjust another corner, follow the same procedure from 1) above. To reset the adjustment of all the corners, select **RESET** using the ▲/▼ buttons and press the **ENTER** or **INPUT** button.

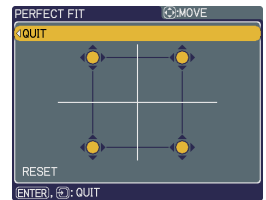
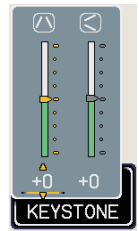

To close the dialog and complete this operation, press **KEYSTONE** button again. Even if you do not do anything, the dialog will automatically disappear after a few seconds.

- While the positions of the corners are adjusted with PERFECT FIT, keystone adjustment feature is unavailable. To correct the keystone distortion, reset the adjustment of all the corners.
- The adjustable range of this function will vary among inputs. For some input, this function may not work well.
- When the zoom adjustment is set to the TELE (telephoto focus), this function may be excessive. This function should be used when the zoom adjustment is set to the full WIDE (wide-angle focus) whenever possible.
- This function will be unavailable when Transition Detector is on (📖 56).

Using the magnify feature

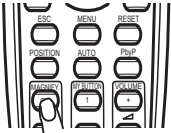
1. Press the **ON** button of **MAGNIFY** on the remote control. The “MAGNIFY” indication will appear on the screen and the projector will go into the MAGNIFY mode. When the **ON** button of **MAGNIFY** is pressed first after the projector is started, the picture will be zoomed. The indication will disappear in several seconds with no operation.
 
2. Use the **▲/▼** cursor buttons to adjust the zoom level. To move the zoom area, press the **POSITION** button in the MAGNIFY mode, then use the **▲/▼/◀/▶** cursor buttons to move the area. And to finalize the zoom area, press the **POSITION** button again. To exit from the MAGNIFY mode and restore the screen to normal, press the **OFF** button of **MAGNIFY** on the remote control.
 - The projector automatically exits from the MAGNIFY mode when the input signal is changed or when the display condition is changed.
 - In the MAGNIFY mode, the keystone distortion condition may vary, it will be restored when the projector exits from the MAGNIFY mode.

NOTE • The zoom level can be finely adjusted. Closely watch the screen to find the level you want.

Freezing the screen

1. Press the **FREEZE** button on the remote control. The “FREEZE” indication will appear on the screen (however, the indication will not appear when the TURN OFF is selected for the MESSAGE item in the SCREEN Menu (45)), and the projector will go into the FREEZE mode, which the picture is frozen.
 

To exit the FREEZE mode and restore the screen to normal, press the **FREEZE** button again.

 - The projector automatically exits from the FREEZE mode when some control buttons are pressed.
 - If the projector continues projecting a still image for a long time, the LCD panel might possibly be burned in. Do not leave the projector in the FREEZE mode for too long.

Temporarily blanking the screen

1. Press the **BLANK** button on the remote control.
 - The blank screen will be displayed instead of the screen of input signal. Please refer to the BLANK item in SCREEN Menu (📖42).
To exit from the blank screen and return to the input signal screen, press the **BLANK** button again.
 - The projector automatically exits from the BLANK mode when some control buttons are pressed.

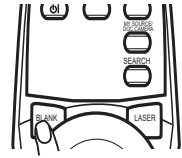

⚠ CAUTION ► If you wish to have a blank screen while the projector's lamp is on, use the BLANK function above. Any other method of blocking the projection light, such as attaching something to the lens or placing something in front of the lens, may cause the damage to the projector.

NOTE • The sound is not connected with the blank screen function. If necessary, set the volume or mute first.

PbyP (Picture by Picture)

The **PbyP** is a function to display two different picture signals on a screen that is split in two areas for each signal. Some of functions can be used with the same operation as it for the normal mode (not in the **PbyP** mode). There are some operations available only in the **PbyP** mode.

Starting the PbyP

Press the **PbyP** button on the remote control, then the **PbyP** function will be started. To quit the **PbyP** mode, press the button again.

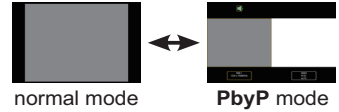

Showing the setting information

The setting information will be appeared for several seconds when the **PbyP** function is started. It shows the input signal information for each area. Also, there will be a yellow frame and speaker mark with one of the area that is the main area where most of operations are effective. The information can be appeared using the cursor buttons **▲/▼/◀/▶** when the setting information is not on the screen.

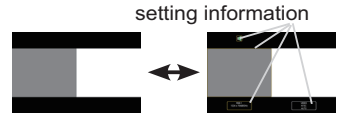

Changing the main area

Most of operations are effective for the main area only. Also the audio input signal paired with the picture input signal for the main area is assigned as the audio output signal. The main area can be changed using the cursor buttons **◀/▶** when the setting information is on the screen.

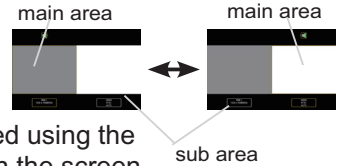

Changing the picture input signal

Press the **INPUT**, **RGB** or **VIDEO** button while in the **PbyP** mode, the menu to select the input signal will be appeared. Choose a signal using the cursor buttons **▲/▼**. If you want to change the signal in the sub area, switch the main area using the cursor buttons **◀/▶** first. Displaying the same signal on the both areas is not allowed. For other combinations of the input signal, refer to the right table. Any combinations marked with X can not be selected.

| | | <signal combination> | | | | | |
|-------|-----------|----------------------|------|------|-----------|-----------|---------|
| | | Main | | | | | |
| | | RGB1 | RGB2 | HDMI | Component | Scart RGB | S-Video |
| Sub | RGB1 | 0 | 0 | 0 | 0 | 0 | 0 |
| | RGB2 | 0 | 0 | 0 | 0 | 0 | 0 |
| | HDMI | 0 | 0 | 0 | X | X | X |
| | Component | 0 | 0 | 0 | 0 | 0 | 0 |
| | Scart RGB | 0 | 0 | X | 0 | X | X |
| | S-Video | 0 | 0 | X | 0 | X | X |
| Video | 0 | 0 | X | 0 | X | X | |

Using the PbyP SWAP function

Press the **MY BUTTON1/2** assigned the **PbyP SWAP** (49). The position of the both area is exchanged without any setting change.



NOTE •For some signals, it may not be displayed correctly in the **PbyP** mode, even if it can be displayed properly in the normal mode.

Using the menu function

This projector has the following menus: PICTURE, IMAGE, INPUT, SETUP, AUDIO, SCREEN, OPTION, NETWORK, C.C. and EASY MENU. The EASY MENU consists of functions often used, and the other menus are classified into each purpose and brought together as the Advanced Menu. Each of these menus is operated using the same methods. The basic operations of these menus are as follows.

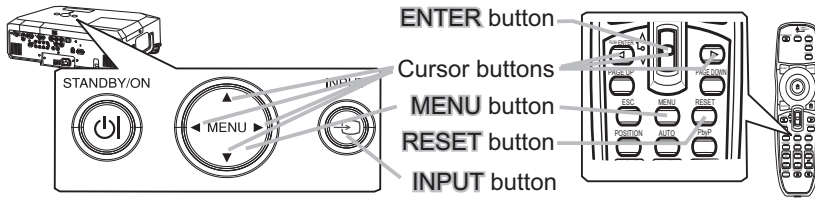

1. Press the **MENU** button on the remote control or one of the cursor buttons on the projector. The Advanced MENU, or EASY MENU that has priority just after powered on, will appear. If you want to move the menu position, use the cursor buttons after pressing the **POSITION** button. While the projector is displaying any menu, the **MENU** button on the projector works as the cursor buttons.

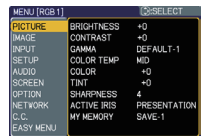

In the EASY MENU

2. If you want to change it to the Advanced MENU, select the "Go to Advanced Menu..."
3. Use the ▲/▼ cursor buttons to select an item to operate.
4. Use the ◀/▶ cursor buttons to operate the item.

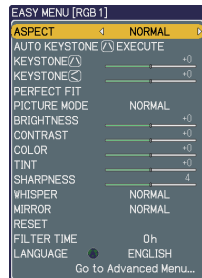

In the Advanced MENU

2. Use the ▲/▼ cursor buttons to select a menu. If you want to change it to the EASY MENU, select the EASY MENU. Then press the ▶ cursor button on the projector or remote control, or the **ENTER** button on the remote control to select an item. The display of the selected menu will be active.
3. Use the ▲/▼ cursor buttons to select an item to operate. Then press the ▶ cursor button on the projector or remote control, or the **ENTER** button on the remote control to progress. The operation menu of the selected item will appear.
4. Use the ▲/▼ cursor buttons to operate the item.
 - Some functions cannot be performed when a certain input port is selected, or when a certain input signal is displayed.
 - When you want to reset the operation, press the **RESET** button on the remote control during the operation. Note that items whose functions are performed simultaneously with operation (ex. LANGUAGE, H PHASE, VOLUME etc.) cannot be reset.
 - In the Advanced MENU, when you want to return to the previous display, press the ◀ cursor button on the projector or remote control, or the **ESC** button on the remote control.
5. Press the **MENU** button on the remote control again to close the menu and complete this operation. Even if you do not do anything, the dialog will automatically disappear after about 10 seconds.

EASY MENU

From the EASY MENU, items shown in the table below can be performed.

Select an item using the ▲/▼ cursor buttons on the projector or remote control. Then perform it according to the following table.

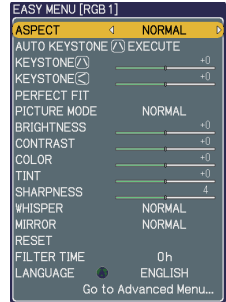

| Item | Description | | | | | | | | | | | | | | | | | | | | | | | | |
|------------------------------|--|------------|------------|-------|--------|--------|------------|--------|--------|------------|---------|---------|------------|--------------|----------------|------------|--------------|----------------|------------|------------|--------|------------|---------|----------------|------------|
| ASPECT | Using the ◀/▶ buttons switches the mode for aspect ratio. See the ASPECT item in IMAGE Menu (📖32). | | | | | | | | | | | | | | | | | | | | | | | | |
| AUTO KEYSTONE EXECUTE | Using the ▶ button executes the auto keystone function. See the AUTO KEYSTONE EXECUTE item in SETUP Menu (📖38). | | | | | | | | | | | | | | | | | | | | | | | | |
| KEYSTONE | Using the ◀/▶ buttons corrects the vertical keystone distortion. See the KEYSTONE item in SETUP Menu (📖38). | | | | | | | | | | | | | | | | | | | | | | | | |
| KEYSTONE | Using the ◀/▶ buttons corrects the horizontal keystone distortion. See the KEYSTONE item in SETUP Menu (📖39). | | | | | | | | | | | | | | | | | | | | | | | | |
| PERFECT FIT | Using the ▶ button displays the dialog for the shape adjustment of the projected image in each of the corners. See the PERFECT FIT item in SETUP menu (📖39). | | | | | | | | | | | | | | | | | | | | | | | | |
| PICTURE MODE | <p>Using the ◀/▶ buttons switches the picture mode. The picture modes are combinations of GAMMA and COLOR TEMP settings. Choose a suitable mode according to the projected source.</p> <p> </p> <table border="1"> <thead> <tr> <th></th> <th>COLOR TEMP</th> <th>GAMMA</th> </tr> </thead> <tbody> <tr> <td>NORMAL</td> <td>#2 MID</td> <td>#1 DEFAULT</td> </tr> <tr> <td>CINEMA</td> <td>#3 LOW</td> <td>#2 DEFAULT</td> </tr> <tr> <td>DYNAMIC</td> <td>#1 HIGH</td> <td>#3 DEFAULT</td> </tr> <tr> <td>BOARD(BLACK)</td> <td>#4 Hi-BRIGHT-1</td> <td>#4 DEFAULT</td> </tr> <tr> <td>BOARD(GREEN)</td> <td>#5 Hi-BRIGHT-2</td> <td>#4 DEFAULT</td> </tr> <tr> <td>WHITEBOARD</td> <td>#2 MID</td> <td>#5 DEFAULT</td> </tr> <tr> <td>DAYTIME</td> <td>#6 Hi-BRIGHT-3</td> <td>#6 DEFAULT</td> </tr> </tbody> </table> <ul style="list-style-type: none"> • When the combination of GAMMA and COLOR TEMP differs from pre-assigned modes above, the display on the menu for the PICTURE MODE is “CUSTOM”. Please refer to the GAMMA and COLOR TEMP (📖29, 30) items in PICTURE Menu. • When this function is performed, a certain extra such as a line may appear. | | COLOR TEMP | GAMMA | NORMAL | #2 MID | #1 DEFAULT | CINEMA | #3 LOW | #2 DEFAULT | DYNAMIC | #1 HIGH | #3 DEFAULT | BOARD(BLACK) | #4 Hi-BRIGHT-1 | #4 DEFAULT | BOARD(GREEN) | #5 Hi-BRIGHT-2 | #4 DEFAULT | WHITEBOARD | #2 MID | #5 DEFAULT | DAYTIME | #6 Hi-BRIGHT-3 | #6 DEFAULT |
| | COLOR TEMP | GAMMA | | | | | | | | | | | | | | | | | | | | | | | |
| NORMAL | #2 MID | #1 DEFAULT | | | | | | | | | | | | | | | | | | | | | | | |
| CINEMA | #3 LOW | #2 DEFAULT | | | | | | | | | | | | | | | | | | | | | | | |
| DYNAMIC | #1 HIGH | #3 DEFAULT | | | | | | | | | | | | | | | | | | | | | | | |
| BOARD(BLACK) | #4 Hi-BRIGHT-1 | #4 DEFAULT | | | | | | | | | | | | | | | | | | | | | | | |
| BOARD(GREEN) | #5 Hi-BRIGHT-2 | #4 DEFAULT | | | | | | | | | | | | | | | | | | | | | | | |
| WHITEBOARD | #2 MID | #5 DEFAULT | | | | | | | | | | | | | | | | | | | | | | | |
| DAYTIME | #6 Hi-BRIGHT-3 | #6 DEFAULT | | | | | | | | | | | | | | | | | | | | | | | |

(continued on next page)

EASY MENU (continued)

| Item | Description |
|-------------------------------|---|
| BRIGHTNESS | Using the ◀/▶ buttons adjusts the brightness. See the BRIGHTNESS item in PICTURE Menu (📖29). |
| CONTRAST | Using the ◀/▶ buttons adjusts the contrast. See the CONTRAST item in PICTURE Menu (📖29). |
| COLOR | Using the ◀/▶ buttons adjusts the strength of whole color. See the COLOR item in PICTURE Menu (📖30). |
| TINT | Using the ◀/▶ buttons adjusts the tint. See the TINT item in PICTURE Menu (📖30). |
| SHARPNESS | Using the ◀/▶ buttons adjusts the sharpness. See the SHARPNESS item in PICTURE Menu (📖30). |
| WHISPER | Using the ◀/▶ buttons turns off/on the whisper mode. See the WHISPER item in SETUP Menu (📖40). |
| MIRROR | Using the ◀/▶ buttons switches the mode for mirror status. See the MIRROR item in SETUP Menu (📖40). |
| RESET | Performing this item resets all of the EASY MENU items except the FILTER TIME and LANGUAGE. A dialog is displayed for confirmation. Selecting the RESET using the ▲ button performs resetting. |
| FILTER TIME | The usage time of the air filter is shown in the menu. Performing this item resets the filter time which counts usage time of the air filter. A dialog is displayed for confirmation. Selecting the RESET using the ▲ button performs resetting. See the FILTER TIME item in OPTION Menu (📖48). |
| LANGUAGE | Using the ◀/▶ buttons changes the display language. See the LANGUAGE item in SCREEN Menu (📖42). |
| Go to Advanced Menu... | Select “Go to Advanced Menu...” on the menu, and press the ▶ or ENTER button to use the menu of PICTURE, IMAGE, INPUT, SETUP, AUDIO, SCREEN, OPTION, NETWORK or C.C.. |

PICTURE Menu

From the PICTURE Menu, items shown in the table below can be performed. Select an item using the ▲/▼ cursor buttons on the projector or remote control, and press the ► cursor button on the projector or remote control, or the **ENTER** button on the remote control to execute the item. Then perform it according to the following table.

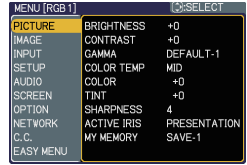

| Item | Description |
|-------------------|---|
| BRIGHTNESS | Using the ▲/▼ buttons adjusts the brightness. Light ⇔ Dark |
| CONTRAST | Using the ▲/▼ buttons adjusts the contrast. Strong ⇔ Weak |
| GAMMA | <p>Using the ▲/▼ buttons switches the gamma mode.</p> <p>#1 DEFAULT ⇔ #1 CUSTOM ⇔ #2 DEFAULT ⇔ #2 CUSTOM ⇔ #3 DEFAULT ⇕ ⇕ #6 CUSTOM #3 CUSTOM ⇕ ⇕ #6 DEFAULT ⇔ #5 CUSTOM ⇔ #5 DEFAULT ⇔ #4 CUSTOM ⇔ #4 DEFAULT</p> <p>To adjust CUSTOM</p> <p>Selecting a mode whose name includes CUSTOM and then pressing the ► button or the ENTER button displays a dialog to aid you in adjusting the mode.</p> <p>This function is useful when you want to change the brightness of particular tones.</p> <p>Choose an item using the ◀/▶ buttons, and adjust the level using the ▲/▼ buttons.</p> <p>You can display a test pattern for checking the effect of your adjustment by pressing the ENTER button. Each time you press the ENTER button, the pattern changes as below.</p> <p>No pattern ⇔ Gray scale of 9 steps ⇐</p> <p>⇑ ——— Ramp ⇐ Gray scale of 15 steps</p> <p>The eight equalizing bars correspond to eight tone levels of the test pattern (Gray scale of 9 steps) except the darkest in the left end. If you want to adjust the 2nd tone from left end on the test pattern, use the equalizing adjustment bar "1". The darkest tone at the left end of the test pattern cannot be controlled with any of equalizing adjustment bar.</p> <ul style="list-style-type: none"> When this function is performed, lines or other distortion may appear. |

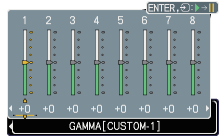

(continued on next page)

PICTURE Menu (continued)

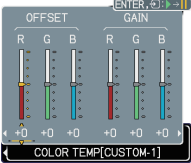
| Item | Description |
|--------------------------|---|
| <p>COLOR TEMP</p> | <p>Using the ▲/▼ buttons switches the color temperature mode.</p> <p>#1 HIGH ⇄ #1 CUSTOM ⇄ #2 MID ⇄ #2 CUSTOM ⇄ #3 LOW ⇅ ⇅ #6 CUSTOM #3 CUSTOM ⇅ ⇅ #6 HI-BRIGHT-3 #4 HI-BRIGHT-1 ⇅ ⇅ #5 CUSTOM ⇄ #5 HI-BRIGHT-2 ⇄ #4 CUSTOM</p> <p>To adjust CUSTOM</p> <p>Selecting a mode whose name includes CUSTOM and then pressing the ► button or the ENTER button displays a dialog to aid you in adjusting the OFFSET and GAIN of the selected mode.</p> <p>OFFSET adjustments change the color intensity on the whole tones of the test pattern.</p> <p>GAIN adjustments mainly affect color intensity on the brighter tones of the test pattern.</p> <p>Choose an item using the ◀/▶ buttons, and adjust the level using the ▲/▼ buttons.</p> <p>You can display a test pattern for checking the effect of your adjustment by pressing the ENTER button. Each time you press the ENTER button, the pattern changes as below.</p> <p>No pattern ⇄ Gray scale of 9 steps ⇨ ⇨ Ramp ⇄ Gray scale of 15 steps</p> <ul style="list-style-type: none"> • When this function is performed, lines or other distortion may appear.  |
| <p>COLOR</p> | <p>Using the ▲/▼ buttons adjusts the strength of whole color.</p> <p>Strong ⇄ Weak</p> <ul style="list-style-type: none"> • This item can be selected only for a video signal, s-video, component video or HDMI signal. |
| <p>TINT</p> | <p>Using the ▲/▼ buttons adjusts the tint.</p> <p>Greenish ⇄ Reddish</p> <ul style="list-style-type: none"> • This item can be selected only for a video signal, s-video, component video or HDMI signal. |
| <p>SHARPNESS</p> | <p>Using the ▲/▼ buttons adjusts the sharpness.</p> <p>Strong ⇄ Weak</p> <ul style="list-style-type: none"> • There may be some noise and/or the screen may flicker for a moment when an adjustment is made. This is not a malfunction. |

(continued on next page)

PICTURE Menu (continued)

| Item | Description | | | | | | | | |
|---------------------------|--|--|---------|--------------|---|---------|--|----------|---------------------------------|
| <p>ACTIVE IRIS</p> | <p>Using the ▲/▼ cursor buttons changes the active iris control mode. PRESENTATION ⇄ THEATER ⇄ TURN OFF</p>  <table border="1" data-bbox="318 323 1014 491"> <thead> <tr> <th></th> <th>Feature</th> </tr> </thead> <tbody> <tr> <td>PRESENTATION</td> <td>The active iris displays the best presentation image for both bright and dark scenes.</td> </tr> <tr> <td>THEATER</td> <td>The active iris displays the best theater image for both bright and dark scenes.</td> </tr> <tr> <td>TURN OFF</td> <td>The active iris is always open.</td> </tr> </tbody> </table> <ul style="list-style-type: none"> • The screen may flicker when the PRESENTATION or THEATER modes are selected. If this occurs select TURN OFF. | | Feature | PRESENTATION | The active iris displays the best presentation image for both bright and dark scenes. | THEATER | The active iris displays the best theater image for both bright and dark scenes. | TURN OFF | The active iris is always open. |
| | Feature | | | | | | | | |
| PRESENTATION | The active iris displays the best presentation image for both bright and dark scenes. | | | | | | | | |
| THEATER | The active iris displays the best theater image for both bright and dark scenes. | | | | | | | | |
| TURN OFF | The active iris is always open. | | | | | | | | |
| <p>MY MEMORY</p> | <p>This projector has 4 memories for adjustment data (for all the items of the PICTURE Menu). Selecting a function using the ▲/▼ buttons and pressing the ► or ENTER button performs each function.</p>  <p><u>LOAD-1, LOAD-2, LOAD-3, LOAD-4</u></p> <p>Performing a LOAD function loads the data from the memory linked in the number included in the function's name, and adjusts the picture automatically depending on the data.</p> <ul style="list-style-type: none"> • The LOAD functions whose linked memory has no data are skipped. • Remember that the current adjusted condition will be lost by loading data. If you want to keep the current adjustment, please save it before performing a LOAD function. • There may be some noise and the screen may flicker for a moment when loading data. This is not malfunction. • The LOAD functions can be also performed by the MY MEMORY button which can be set by the MY BUTTON item in OPTION Menu (49). <p><u>SAVE-1, SAVE-2, SAVE-3, SAVE-4</u></p> <p>Performing a SAVE function saves the current adjustment data into the memory linked in the number included in the function's name.</p> <ul style="list-style-type: none"> • Remember that the current data being stored of a memory will be lost by saving a new data into the memory. | | | | | | | | |

IMAGE Menu

From the IMAGE Menu, items shown in the table below can be performed.

Select an item using the ▲/▼ cursor buttons on the projector or remote control, and press the ► cursor button on the projector or remote control, or **ENTER** button on the remote control to execute the item. Then perform it according to the following table.

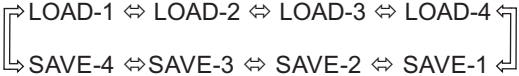
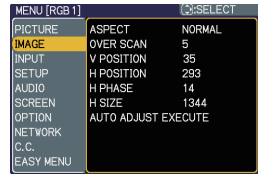

| Item | Description |
|--------------------------|---|
| <p>ASPECT</p> | <p>Using the ▲/▼ buttons switches the mode for aspect ratio.</p> <p>For an RGB signal NORMAL ⇔ 4:3 ⇔ 16:9 ⇔ 16:10 ⇔ REAL ↑↑↑↑↑</p> <p>For an HDMI signal NORMAL ⇔ 4:3 ⇔ 16:9 ⇔ 16:10 ⇔ 14:9 ⇔ REAL ↑↑↑↑↑</p> <p>For a Video signal, S-video signal or Component video signal 4:3 ⇔ 16:9 ⇔ 16:10 ⇔ 14:9 ⇔ REAL ↑↑↑↑↑</p> <p>For no signal 16:10 (fixed)</p> <ul style="list-style-type: none"> • The NORMAL mode keeps the original aspect ratio of the signal. • Some input signals may not be displayed in the aspect ratio as selected in the menu. In this case, use the ASPECT button on the remote control to select other aspect ratio. |
| <p>OVER SCAN</p> | <p>Using the ▲/▼ buttons adjusts the over-scan ratio.</p> <p>Large (It reduces picture) ⇔ Small (It magnifies picture)</p> <ul style="list-style-type: none"> • This item can be selected only for a video, s-video, component and HDMI signal. |
| <p>V POSITION</p> | <p>Using the ▲/▼ buttons adjusts the vertical position.</p> <p>Up ⇔ Down</p> <ul style="list-style-type: none"> • Over-adjusting the vertical position may cause noise to appear on the screen. If this occurs, please reset the vertical position to the default setting. Pressing the RESET button when the V POSITION is selected will reset the V POSITION to the default setting. • When this function is performed on a video signal, s-video signal, or component video signal of 480i@60 or 576i@50 input the range of this adjustment depends on the OVER SCAN (above) setting. It is not possible to adjust when the OVER SCAN is set to 10. • This item cannot be selected for an HDMI signal. |
| <p>H POSITION</p> | <p>Using the ▲/▼ buttons adjusts the horizontal position.</p> <p>Left ⇔ Right</p> <ul style="list-style-type: none"> • Over-adjusting the horizontal position may cause noise to appear on the screen. If this occurs, please reset the horizontal position to the default setting. Pressing the RESET button when the H POSITION is selected will reset the H POSITION to the default setting. • When this function is performed on a video signal, s-video signal, or component video signal of 480i@60 or 576i@50 input the range of this adjustment depends on the OVER SCAN (above) setting. It is not possible to adjust when the OVER SCAN is set to 10. • This item cannot be selected for an HDMI signal. |

(continued on next page)

IMAGE Menu (continued)

| Item | Description |
|-----------------------------------|---|
| <p>H PHASE</p> | <p>Using the ▲/▼ buttons adjusts the horizontal phase to eliminate flicker. Right ⇔ Left</p> <ul style="list-style-type: none"> • This item can be selected only for an RGB signal or a component video signal. (except 480i@60, 576i@50, SCART RGB input.) |
| <p>H SIZE</p> | <p>Using the ▲/▼ buttons adjusts the horizontal size. Large ⇔ Small</p> <ul style="list-style-type: none"> • This item can be selected only for an RGB signal. • When this adjustment is excessive, the picture may not be displayed correctly. In such a case, please reset the adjustment by pressing the RESET button on the remote control during this operation. |
| <p>AUTO ADJUST EXECUTE</p> | <p>Selecting this item performs the automatic adjustment feature.</p> <p>For an RGB signal The vertical position, the horizontal position and the horizontal phase will be automatically adjusted. Make sure that the application window is set to its maximum size prior to attempting to use this feature. A dark picture may still be incorrectly adjusted. Use a bright picture when adjusting.</p> <p>For a video signal and s-video signal The video format best suited for the respective input signal will be selected automatically. This function is available only when the AUTO is selected for the VIDEO FORMAT item in the INPUT Menu (📺35). The vertical position and horizontal position will be automatically set to the default.</p> <p>For a component video signal The vertical position, horizontal position and horizontal phase will be automatically set to the default.</p> <ul style="list-style-type: none"> • The automatic adjustment operation requires approx. 10 seconds. Also please note that it may not function correctly with some input. When this function is performed for a video signal, a certain extra such as a line may appear outside a picture. • The items adjusted by this function may vary when the FINE or DISABLE is selected for the AUTO ADJUST item of the SERVICE item in the OPTION Menu (📺50). |

INPUT Menu

From the INPUT Menu, items shown in the table below can be performed.

Select an item using the ▲/▼ cursor buttons on the projector or remote control, and press the ► cursor button on the projector or remote control, or **ENTER** button on the remote control to execute the item. Then perform it according to the following table.

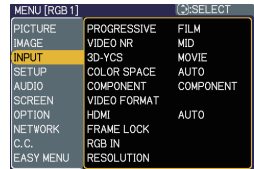

| Item | Description |
|--------------------|---|
| PROGRESSIVE | <p>Using the ▲/▼ buttons switches the progress mode. TV ⇄ FILM ⇄ TURN OFF ↑</p> <ul style="list-style-type: none"> • This function is performed only for an interlaced signal at the VIDEO or S-VIDEO input, and for 480i@60, 576i@50 or 1080i@50/60 signal at the COMPONENT or HDMI input. • When TV or FILM is selected, the screen image will be sharp. FILM adapts to the 2-3 Pull-Down conversion system. But these may cause a certain defect (for example, jagged line) of the picture for a quick moving object. In such a case, please select TURN OFF, even though the screen image may lose the sharpness. |
| VIDEO NR | <p>Using the ▲/▼ buttons switches the noise reduction mode. HIGH ⇄ MID ⇄ LOW ↑</p> <ul style="list-style-type: none"> • This function is performed only for the VIDEO or S-VIDEO input, and for 480i@60, 576i@50 or 1080i@50/60 signal at the COMPONENT or HDMI input. |
| 3D-YCS | <p>Using the ▲/▼ buttons switches the 3D-YCS mode. STILL ⇄ MOVIE ⇄ TURN OFF ↑</p> <ul style="list-style-type: none"> • This function performs only at a VIDEO input of NTSC, and PAL. • MOVIE is the mode for images with a lot of motions like movies, and STILL is the mode for images with few motions or completely still ones like slides. |
| COLOR SPACE | <p>Using the ▲/▼ buttons switches the mode for color space. AUTO ⇄ RGB ⇄ SMPTE240 ⇄ REC709 ⇄ REC601 ↑</p> <ul style="list-style-type: none"> • This item can be selected only for an RGB signal or a component video signal (except 480i@60, 576i@50 and SCART RGB). • The AUTO mode automatically selects the optimum mode. • The AUTO operation may not work well at some signals. In such a case, it might be good to select a suitable mode except AUTO. |

(continued on next page)

INPUT Menu (continued)

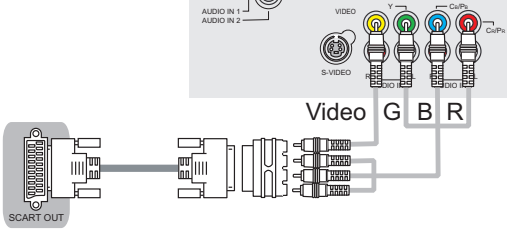
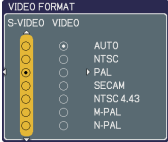
| Item | Description | | | | | | | | |
|----------------------------|---|--|---------|------|---|--------|-----------------------------------|----------|----------------------------------|
| <p>COMPONENT</p> | <p>Using the ▲/▼ buttons switches the function of the COMPONENT (Y, Cb/Pb, Cr/Pr) port.</p> <p>COMPONENT ⇔ SCART RGB</p> <p>When the SCART RGB is selected, the COMPONENT (Y, Cb/Pb, Cr/Pr) and VIDEO ports will function as a SCART RGB port. A SCART adapter or SCART cable is required for a SCART RGB input to the projector. For details, contact your dealer.</p>  | | | | | | | | |
| <p>VIDEO FORMAT</p> | <p>Set the video format for the S-VIDEO port and VIDEO port.</p> <p>(1) Use the ◀/▶ buttons to select the input port.</p> <p>(2) Using the ▲/▼ buttons switches the mode for video format.</p> <p>AUTO ⇔ NTSC ⇔ PAL ⇔ SECAM ↕ N-PAL ⇔ M-PAL ⇔ NTSC4.43 ↕</p> <ul style="list-style-type: none"> • This item is performed only for a video signal from the VIDEO port or the S-VIDEO port. • The AUTO mode automatically selects the optimum mode. • The AUTO operation may not work well for some signals. If the picture becomes unstable (e.g. an irregular picture, lack of color), please select the mode according to the input signal.  | | | | | | | | |
| <p>HDMI</p> | <p>Using the ▲/▼ cursor buttons changes the HDMI signal mode.</p> <p>AUTO ⇔ NORMAL ⇔ ENHANCED</p> <p style="text-align: center;">↑—————↑</p> <table border="1" data-bbox="318 1137 1014 1254"> <thead> <tr> <th></th> <th>Feature</th> </tr> </thead> <tbody> <tr> <td>AUTO</td> <td>Selecting the optimum mode automatically.</td> </tr> <tr> <td>NORMAL</td> <td>Suitable for DVD signals (16-235)</td> </tr> <tr> <td>ENHANCED</td> <td>Suitable for VGA signals (0-255)</td> </tr> </tbody> </table> <ul style="list-style-type: none"> • If the contrast of the screen image is too strong or too weak, try finding a more suitable mode. | | Feature | AUTO | Selecting the optimum mode automatically. | NORMAL | Suitable for DVD signals (16-235) | ENHANCED | Suitable for VGA signals (0-255) |
| | Feature | | | | | | | | |
| AUTO | Selecting the optimum mode automatically. | | | | | | | | |
| NORMAL | Suitable for DVD signals (16-235) | | | | | | | | |
| ENHANCED | Suitable for VGA signals (0-255) | | | | | | | | |

(continued on next page)





INPUT Menu (continued)

| Item | Description |
|--------------------------|---|
| <p>FRAME LOCK</p> | <p>Set the frame lock function on/off for each port.</p> <p>(1) Use the ▲/▼ buttons to select one of following ports. QUIT ⇔ RGB1 ⇔ RGB2 ⇔ HDMI </p> <p>(2) Use the ◀/▶ buttons to turns the frame lock function on/off . TURN ON ⇔ TURN OFF</p> <ul style="list-style-type: none"> • This item can be performed only on a signal with a vertical frequency of 50 to 60 Hz. • When the TURN ON is selected, moving pictures are displayed more smoothly. |
| <p>RGB IN</p> | <p>Set the RGB input signal type for the RGB port.</p> <p>(1) Use the ◀/▶ buttons to select the RGB port to be set. RGB1 ⇔ RGB2</p> <p>(2) Use the ▲/▼ buttons to select the RGB input signal type. AUTO ⇔ SYNC ON G OFF</p> <ul style="list-style-type: none"> • Selecting the AUTO mode allows you to input a sync on G signal or component signal from the port. • In the AUTO mode, the picture may be distorted with certain input signals. In such a case, remove the signal connector so that no signal is received and select the SYNC ON G OFF, and then reconnect the signal. |

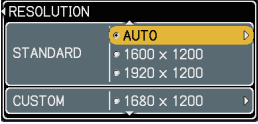

(continued on next page)

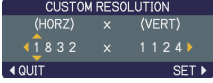
INPUT Menu (continued)

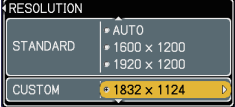

| Item | Description |
|--------------------------|---|
| <p>RESOLUTION</p> | <p>The resolution for the RGB1 and RGB2 input signals can be set on this projector.</p> <p>(1) In the INPUT Menu select the RESOLUTION using the ▲/▼ buttons and press the ► button. The RESOLUTION menu will be displayed.</p>  <p>RESOLUTION menu</p> <p>(2) In the RESOLUTION menu select the resolution you wish to display using the ▲/▼ buttons. Selecting AUTO will set a resolution appropriate to the input signal.</p> <p>(3) Pressing the ► or ENTER button when selecting a STANDARD resolution will automatically adjust the horizontal and vertical positions, clock phase and horizontal size. The INPUT-INFORMATION- dialog (51) will be displayed.</p>  <p>(4) To set a custom resolution use the ▲/▼ buttons to select the CUSTOM and the CUSTOM RESOLUTION BOX will be displayed. Set the horizontal (HORZ) and vertical (VERT) resolutions using the ▲/▼/◀/▶ buttons. It is not guaranteed to work this function properly on any resolutions.</p>  <p>CUSTOM RESOLUTION BOX</p> <p>(5) To save the setting place the cursor on the right-most digit and press the ► button. The horizontal and vertical positions, clock phase and horizontal size will be automatically adjusted. After the INPUT-INFORMATION- (51) dialog has displayed for about 10 seconds the screen will return to the RESOLUTION menu displaying the changed resolution.</p>  <p>• After pressing the ► button, there may be no display or wrong images may be displayed. In this case, press the AUTO button on the remote control for about 3 seconds, or go to (6) below to restore the original resolution setting. The projector does not support the resolution that was set in the RESOLUTION_CUSTOM box. Change the resolution.</p> <p>(6) To revert back to the previous resolution without saving changes place the cursor on the left-most digit and press the ◀ button. The screen will then return to the RESOLUTION menu displaying the previous resolution.</p>  <p>• For some pictures, this function may not work well.</p> |

SETUP Menu

From the SETUP Menu, items shown in the table below can be performed.

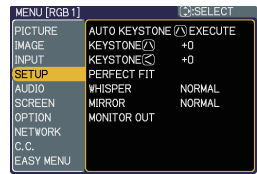
Select an item using the ▲/▼ cursor buttons on the projector or remote control, and press the ► cursor button on the projector or remote control, or the **ENTER** button on the remote control to execute the item. Then perform it according to the following table.



| Item | Description |
|---|---|
| <p>AUTO KEYSTONE EXECUTE </p> | <p>Selecting this item performs the Automatic keystone distortion correction. Projector automatically corrects vertical keystone distortion due to the (forward/backward) setup angle by itself. This function will be executed only once when selected in the menu. When the slant of the projector is changed, execute this function again.</p> <ul style="list-style-type: none"> • The adjustable range of this function will vary among inputs. For some input, this function may not work well. • When V:INVERT or H&V:INVERT is selected to the MIRROR item in the SETUP Menu, if the projector screen is inclined or angled downward, this function may not work correctly. • When the zoom adjustment is set to the TELE (telephoto focus), this function may be excessive. This function should be used when the zoom adjustment is set to the full WIDE (wide-angle focus) whenever possible. • When the projector is placed on the level (about ±3°), this function may not work. • When the projector is inclined to near ±30 degree or over, this function may not work well. • When the vertical lens shift is not set fully upward, this function may not work well. • When the horizontal lens shift is not set to the center, this function may not work well. • This function will be unavailable when the Transition Detector is on (☞56) or the PERFECT FIT (☞39) is adjusted. |
| <p>KEYSTONE </p> | <p>Using the ▲/▼ buttons corrects the vertical keystone distortion.</p> <p>Shrink the top of the image ⇔ Shrink the bottom of the image</p> <ul style="list-style-type: none"> • The adjustable range of this function will vary among inputs. For some input, this function may not work well. • When the horizontal lens shift is not set to the center, this function may not work well. • This function will be unavailable when the Transition Detector is on (☞56) or the PERFECT FIT (☞39) is adjusted. |

(continued on next page)



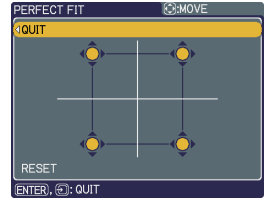

SETUP Menu (continued)

| Item | Description |
|--|---|
| <p>KEYSTONE </p> | <p>Using the ▲/▼ buttons corrects the horizontal keystone distortion.</p> <p>Shrink the right of the image ⇔ Shrink the left of the image</p> <ul style="list-style-type: none"> • The adjustable range of this function will vary among inputs. For some input, this function may not work well. • When the zoom adjustment is set to the TELE (telephoto focus), this function may be excessive. This function should be used when the zoom adjustment is set to the full WIDE (wide-angle focus) whenever possible. • When the vertical lens shift is not set fully upward, this function may not work well. • This function will be unavailable when the Transition Detector is on (F56) or the PERFECT FIT (F39) is adjusted. |
| <p>PERFECT FIT</p> | <p>This item allows you to adjust the shape of the projected image in each of the corners.</p> <ol style="list-style-type: none"> (1) Choose the corner to adjust using the ▲/▼/◀/▶ buttons and press the ENTER or INPUT button. (2) Use the ▲/▼/◀/▶ buttons to adjust the position of the corner. Press the ENTER or INPUT button to exit the adjustment of the corner. (3) To adjust another corner, follow the same procedure from (1) above. To reset the adjustment of all the corners, select RESET using the ▲/▼ buttons and press the ENTER or INPUT button. <ul style="list-style-type: none"> • While this item is adjusted, keystone adjustment feature (F38) is unavailable. To correct the keystone distortion, reset the adjustment of all the corners. • The adjustable range of this correction will vary among inputs. For some input, this function may not work well. • This function will be unavailable when the Transition Detector is on (F56). |



(continued on next page)

SETUP Menu (continued)

| Item | Description | | | | | | | | | | | | | | | | | | | | | | | | | | | | | | | | | | | | |
|---------------------------|---|---|-----|--|--|--|---|---|-----|------|---|---|---|------|---|---|---|------|---|---|---|-----------|---|---|---|---------|---|---|---|-------|---|---|---|---------|---|---|---|
| <p>WHISPER</p> | <p>Using the ▲/▼ buttons turns off/on the whisper mode. NORMAL ⇔ WHISPER</p> <ul style="list-style-type: none"> • When the WHISPER is selected, acoustic noise and screen brightness are reduced. | | | | | | | | | | | | | | | | | | | | | | | | | | | | | | | | | | | | |
| <p>MIRROR</p> | <p>Using the ▲/▼ buttons switches the mode for mirror status.</p> <div style="display: flex; justify-content: space-around; align-items: center;">     </div> <p>NORMAL ⇔ H:INVERT ⇔ V:INVERT ⇔ H&V:INVERT</p> <p style="text-align: center;">↑—————↑</p> <p>If the Transition Detector is TURN ON and MIRROR status is changed, Transition Detector Alarm (🔔56) will be displayed when projector is restarted after the power switch is turned off.</p> | | | | | | | | | | | | | | | | | | | | | | | | | | | | | | | | | | | | |
| <p>MONITOR OUT</p> | <p>The combination of a picture shown on screen and output from the RGB OUT port can be arranged in the menu. The picture coming into the port selected in the (2) is output to the RGB OUT port while an image from the port chosen in the (1) is on screen.</p> <p>(1) Choose a picture input port using ▲/▼ buttons. ↵ QUIT ⇔ RGB1 ⇔ RGB2 ⇔ HDMI ⇐ STANDBY ⇔ VIDEO ⇔ S-VIDEO ⇔ COMPONENT(Y, Cb/Pb, Cr/Pr)</p> <ul style="list-style-type: none"> • Choose STANDBY, to select the output signal from the RGB OUT port in the standby mode. • While QUIT is selected, pressing the ◀ button returns to the previous menu. <p>(2) Select one of the RGB ports using ◀/▶ buttons.</p> <p style="text-align: center;">RGB1 ⇔ RGB2 ⇔ OFF</p> <p style="text-align: center;">↑—————↑</p> <ul style="list-style-type: none"> • OFF disables the RGB OUT port. <div style="border: 1px solid black; padding: 5px; margin-top: 10px;"> <p style="text-align: center; font-weight: bold;">MONITOR OUT</p> <p style="text-align: center; background-color: #f0f0f0;">QUIT</p> <table style="width: 100%; border-collapse: collapse;"> <thead> <tr> <th></th> <th colspan="3" style="text-align: center;">RGB</th> </tr> <tr> <th></th> <th style="text-align: center;">1</th> <th style="text-align: center;">2</th> <th style="text-align: center;">OFF</th> </tr> </thead> <tbody> <tr> <td>RGB1</td> <td style="text-align: center;">●</td> <td style="text-align: center;">○</td> <td style="text-align: center;">○</td> </tr> <tr> <td>RGB2</td> <td style="text-align: center;">○</td> <td style="text-align: center;">●</td> <td style="text-align: center;">○</td> </tr> <tr> <td>HDMI</td> <td style="text-align: center;">○</td> <td style="text-align: center;">○</td> <td style="text-align: center;">○</td> </tr> <tr> <td>COMPONENT</td> <td style="text-align: center;">○</td> <td style="text-align: center;">○</td> <td style="text-align: center;">○</td> </tr> <tr> <td>S-VIDEO</td> <td style="text-align: center;">○</td> <td style="text-align: center;">○</td> <td style="text-align: center;">○</td> </tr> <tr> <td>VIDEO</td> <td style="text-align: center;">○</td> <td style="text-align: center;">○</td> <td style="text-align: center;">○</td> </tr> <tr> <td>STANDBY</td> <td style="text-align: center;">○</td> <td style="text-align: center;">○</td> <td style="text-align: center;">●</td> </tr> </tbody> </table> </div> | | RGB | | | | 1 | 2 | OFF | RGB1 | ● | ○ | ○ | RGB2 | ○ | ● | ○ | HDMI | ○ | ○ | ○ | COMPONENT | ○ | ○ | ○ | S-VIDEO | ○ | ○ | ○ | VIDEO | ○ | ○ | ○ | STANDBY | ○ | ○ | ● |
| | RGB | | | | | | | | | | | | | | | | | | | | | | | | | | | | | | | | | | | | |
| | 1 | 2 | OFF | | | | | | | | | | | | | | | | | | | | | | | | | | | | | | | | | | |
| RGB1 | ● | ○ | ○ | | | | | | | | | | | | | | | | | | | | | | | | | | | | | | | | | | |
| RGB2 | ○ | ● | ○ | | | | | | | | | | | | | | | | | | | | | | | | | | | | | | | | | | |
| HDMI | ○ | ○ | ○ | | | | | | | | | | | | | | | | | | | | | | | | | | | | | | | | | | |
| COMPONENT | ○ | ○ | ○ | | | | | | | | | | | | | | | | | | | | | | | | | | | | | | | | | | |
| S-VIDEO | ○ | ○ | ○ | | | | | | | | | | | | | | | | | | | | | | | | | | | | | | | | | | |
| VIDEO | ○ | ○ | ○ | | | | | | | | | | | | | | | | | | | | | | | | | | | | | | | | | | |
| STANDBY | ○ | ○ | ● | | | | | | | | | | | | | | | | | | | | | | | | | | | | | | | | | | |

AUDIO Menu

From the AUDIO Menu, items shown in the table below can be performed.

Select an item using the ▲/▼ cursor buttons on the projector or remote control, and press the ► cursor button on the projector or remote control, or **ENTER** button on the remote control to execute the item. Then perform it according to the following table.



NOTE • The speaker sound may distorted or the case may be trembling when the volume is too high or treble/bass is emphasized or WOW is activated. In that case, make the volume reduced, bass/treble low or WOW effect to be weakend.

| Item | Description |
|-------------------|---|
| VOLUME | Using the ▲/▼ buttons adjusts the volume. High ⇔ Low |
| TREBLE | Using the ▲/▼ buttons adjusts the treble level. High ⇔ Low |
| BASS | Using the ▲/▼ buttons adjusts the bass level. High ⇔ Low |
| SPEAKER | Using the ▲/▼ buttons turns the speaker function on/off. TURN ON ⇔ TURN OFF • When the TURN ON is selected the built-in speaker works. |
| AUDIO | <p>Allocates the audio ports.</p> <p>(1) Choose a picture input port using the ▲/▼ buttons. ⇨ QUIT ⇔ RGB1 ⇔ RGB2 ⇔ HDMI ⇔ COMPONENT AUDIO OUT STANDBY ⇔ VIDEO ⇔ S-VIDEO ⇨</p> <p>(2) Select the audio port to be interlocked with the input port using the ◀/▶ buttons. 1 ⇔ 2 ⇔ 3 ⇔ 4 ⇔ ✕ ⇔ H ↑</p> <p>• H is abbreviation of HDMI. • H can be selected for HDMI port only. When H is selected, the audio signal to HDMI port will be output if HDMI is chosen as a display source. • ✕ disables the audio output. • When ✕ is selected to VIDEO, S-VIDEO or COMPONENT port, the C.C. (Closed Caption) is automatically activated, if the C.C. is set to AUTO in the DISPLAY Menu of the C.C. Menu and the signal from the input port supports the C.C. feature (65).</p> |
| HDMI AUDIO | The HDMI AUDIO is set to 1 as default. In case the HDMI audio does not work well, try 2. 1 ⇔ 2 |



SCREEN Menu

SCREEN Menu

From the SCREEN Menu, items shown in the table below can be performed.

Select an item using the ▲/▼ cursor buttons on the projector or remote control, and press the ► cursor button on the projector or remote control, or **ENTER** button on the remote control to execute the item. Then perform it according to the following table.

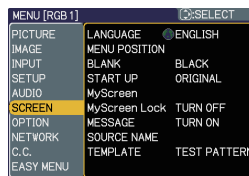

| Item | Description | | | | | | | | |
|----------------------|--|--|---------|----------|---|----------|---------------------------------------|--------------------|------------------------------|
| LANGUAGE | Using the ▲/▼ buttons switches the OSD (On Screen Display) language. ENGLISH ⇄ FRANÇAIS ⇄ DEUTSCH ⇄ ESPAÑOL ⇄ ITALIANO ⇕ TÜRKÇE NORSK ⇕ POLSKI NEDERLANDS ⇕ SUOMI PORTUGUÊS ⇕ РУССКИЙ ⇄ SVENSKA ⇄ 한글 ⇄ 繁體中文 ⇄ 简体中文 ⇄ 日本語 | | | | | | | | |
| MENU POSITION | Using the ▲/▼/◀/▶ buttons adjusts the menu position. To quit the operation, press the MENU button on the remote control or keep no operation for about 10 seconds. | | | | | | | | |
| BLANK | Using the ▲/▼ buttons switches the mode for the blank screen. The blank screen is a screen for the temporarily blanking feature (44). It is displayed by pressing the BLANK button on the remote control. MyScreen ⇄ ORIGINAL ⇄ BLUE ⇄ WHITE ⇄ BLACK ↑—————↑ <table border="1" style="width: 100%;"> <thead> <tr> <th></th> <th>Feature</th> </tr> </thead> <tbody> <tr> <td>MyScreen</td> <td>Screen can be registered by the MyScreen item (44).</td> </tr> <tr> <td>ORIGINAL</td> <td>Screen preset as the standard screen.</td> </tr> <tr> <td>BLUE, WHITE, BLACK</td> <td>Plain screens in each color.</td> </tr> </tbody> </table> <ul style="list-style-type: none"> To avoid remaining as an afterimage, the MyScreen or ORIGINAL screen will change to the plain black screen after several minutes. | | Feature | MyScreen | Screen can be registered by the MyScreen item (44). | ORIGINAL | Screen preset as the standard screen. | BLUE, WHITE, BLACK | Plain screens in each color. |
| | Feature | | | | | | | | |
| MyScreen | Screen can be registered by the MyScreen item (44). | | | | | | | | |
| ORIGINAL | Screen preset as the standard screen. | | | | | | | | |
| BLUE, WHITE, BLACK | Plain screens in each color. | | | | | | | | |



(continued on next page)

SCREEN Menu (continued)

| Item | Description | | | | | | | | |
|--|---|--|---------|----------|--|----------|---------------------------------------|----------|---------------------|
| <p>START UP</p> | <p>Using the ▲/▼ buttons switches the mode for the start-up screen. The start-up screen is a screen displayed when no signal or an unsuitable signal is detected.</p> | | | | | | | | |
| | <p style="text-align: center;">MyScreen ⇄ ORIGINAL ⇄ TURN OFF</p> <p style="text-align: center;">↑—————↑</p> | | | | | | | | |
| | <table border="1" style="width: 100%;"> <thead> <tr> <th style="width: 50%;"></th> <th style="width: 50%;">Feature</th> </tr> </thead> <tbody> <tr> <td>MyScreen</td> <td>Screen can be registered by the MyScreen item (☐44).</td> </tr> <tr> <td>ORIGINAL</td> <td>Screen preset as the standard screen.</td> </tr> <tr> <td>TURN OFF</td> <td>Plain black screen.</td> </tr> </tbody> </table> | | Feature | MyScreen | Screen can be registered by the MyScreen item (☐44). | ORIGINAL | Screen preset as the standard screen. | TURN OFF | Plain black screen. |
| | | Feature | | | | | | | |
| | MyScreen | Screen can be registered by the MyScreen item (☐44). | | | | | | | |
| ORIGINAL | Screen preset as the standard screen. | | | | | | | | |
| TURN OFF | Plain black screen. | | | | | | | | |
| <p>• To avoid remaining as an afterimage, the MyScreen or ORIGINAL screen will change to the BLANK screen (☐42) after several minutes. If also the BLANK screen is the MyScreen or ORIGINAL, the plain black screen is instead used.</p> | | | | | | | | | |
| <p>• When the TURN ON is selected to the MyScreen PASSWORD of SECURITY item in OPTION Menu (☐53), the START UP is fixed to MyScreen.</p> | | | | | | | | | |





(continued on next page)

SCREEN Menu (continued)

| Item | Description |
|-----------------------------|---|
| <p>MyScreen</p> | <p>This item allows you to capture an image for use as a MyScreen image which can be used as the BLANK screen and START UP screen. Display the image you want to capture before executing the following procedure.</p> <ol style="list-style-type: none"> 1. Selecting this item displays a dialog titled “MyScreen”. It will ask you if you start capturing an image from the current screen.  <p>Please wait for the target image to be displayed, and press the ENTER button on the remote control when the image is displayed. The image will freeze and the frame for capturing will appear.</p> <p>To stop performing, press the RESET or ESC button on the remote control.</p> 2. Using the ▲/▼/◀/▶ buttons adjusts the frame position. <p>Please move the frame to the position of the image which you want to use. The frame may not be able to be moved for some input signals.</p>  <p>To start registration, press the ENTER button on the remote control.</p> <p>To restore the screen and return to the previous dialog, press the RESET or ESC button on the remote control.</p> <p>Registration takes several minutes.</p> <p>When the registration is completed, the registered screen and the following message is displayed for several seconds:</p> <p>“MyScreen registration is finished.”</p> <p>If the registration failed, the following message is displayed:</p> <p>“A capturing error has occurred. Please try again.”</p> <ul style="list-style-type: none"> • This item cannot be selected for an HDMI signal. • This function cannot be selected when the TURN ON is selected to the MyScreen Lock item (see below). • This function cannot be selected when the TURN ON is selected to the MyScreen PASSWORD of SECURITY item in OPTION Menu (see 53). |
| <p>MyScreen Lock</p> | <p>Using the ▲/▼ buttons turns on/off the MyScreen lock function.</p> <p>TURN ON ⇔ TURN OFF</p> <p>When the TURN ON is selected, the item MyScreen is locked. Use this function for protecting the current MyScreen.</p> <ul style="list-style-type: none"> • This function cannot be selected when the TURN ON is selected to the MyScreen PASSWORD of SECURITY item in OPTION Menu (see 53). |

(continued on next page)

SCREEN Menu (continued)



| Item | Description |
|---------------------------|---|
| <p>MESSAGE</p> | <p>Using the ▲/▼ buttons turns on/off the message function. TURN ON ⇔ TURN OFF</p> <p>When the TURN ON is selected, the following message function works. “AUTO IN PROGRESS” while automatically adjusting “NO INPUT IS DETECTED” “SYNC IS OUT OF RANGE” “INVALID SCAN FREQ” “Searching....” while searching for the input “Detecting....” while an input signal is detected The indication of the input signal displayed by changing The indication of the aspect ratio displayed by changing The indication of the PICTURE MODE displayed by changing The indication of the ACTIVE IRIS displayed by changing The indication of the MY MEMORY displayed by changing The indication of “FREEZE” and “II” while freezing the screen by pressing the FREEZE button.</p> <ul style="list-style-type: none"> • When the TURN OFF is selected, please remember if the picture is freezing. Do not mistake freezing for a malfunction (23). |
| <p>SOURCE NAME</p> | <p>Each input port for this projector can have a name applied to it.</p> <p>(1) Use the ▲/▼ buttons on the SCREEN Menu to select SOURCE NAME and press the ► button. The SOURCE NAME menu will be displayed.</p>  <p>(2) Use the ▲/▼ buttons on the SOURCE NAME menu to select the port to be named and press the ► button. Right side of the menu is blank until a name is specified. The SOURCE NAME dialog will be displayed.</p>  <p>(3) The current name will be displayed on the first line. Use the ▲/▼/◀/▶ buttons and the ENTER or INPUT button to select and enter characters. The RESET button can be used to erase 1 character at a time. Also if you move the cursor to DELETE or ALL CLEAR on screen and push the ENTER or INPUT button, 1 character or all characters will be erased. The name can be a maximum of 16 characters.</p>  <p>(4) To change an already inserted character, press the ▲ button to move the cursor to the first line, and use the ◀/▶ buttons to move the cursor on the character to be changed. After pressing the ENTER or INPUT button, the character is selected. Then, follow the same procedure as described at the item (3) above.</p>  <p>(5) To finish entering text, move the cursor to the SAVE on screen and press the ENTER or INPUT button. To revert to the previous name without saving changes, move the cursor to the CANCEL on screen and press the ENTER or INPUT button.</p> |

(continued on next page)

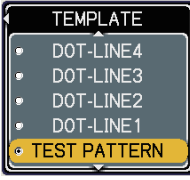
SCREEN Menu (continued)



| Item | Description |
|------------------------|---|
| <p>TEMPLATE</p> | <p>Using ▲/▼ buttons switches the mode for the template screen. The selected template pattern can be displayed when the MY BUTTON allocated to the TEMPLATE function is pressed (49).</p> <p> ↵ DOT-LINE4 ↔ DOT-LINE3 ↔ DOT-LINE2 TEST PATTERN ↔ DOT-LINE1 ←↕ </p>  |

OPTION Menu (continued)

| Item | Description |
|---------------------------|--|
| <p>AUTO OFF</p> | <p>Using the ▲/▼ buttons adjusts the time to count down to automatically turn the projector off. Long (max. 99 minutes) ⇔ Short (min. 0 minute = DISABLE)</p> <div style="display: flex; justify-content: space-around; align-items: center;">   </div> <p>When the time is set to 0, the projector is not turned off automatically. When the time is set to 1 to 99, and when the passed time with no-signal or an unsuitable signal reaches at the set time, the projector lamp will be turned off. If one of the projector's buttons or the remote control buttons is pressed or one of the commands (except get commands) is transmitted to the CONTROL port during the corresponding time, projector will not be turned off. Please refer to the section "Turning off the power" (U17).</p> |
| <p>LAMP TIME</p> | <p>The lamp time is the usage time of the lamp, counted after the last resetting. It is shown in the OPTION Menu. Pressing the RESET button on the remote control or the ► button of the projector displays a dialog. To reset the lamp time, select the RESET using the ▲ button. RESET ⇔ CANCEL</p> <ul style="list-style-type: none"> • Please reset the lamp time only when you have replaced the lamp, for a suitable indication about the lamp. • For the lamp replacement, see the section "Lamp" (U66, 67). |
| <p>FILTER TIME</p> | <p>The filter time is the usage time of the air filter, counted after the last resetting. It is shown in the OPTION Menu. Pressing the RESET button on the remote control or the ► button of the projector displays a dialog. To reset the filter time, select the RESET using the ▲ button. RESET ⇔ CANCEL</p> <ul style="list-style-type: none"> • Please reset the filter time only when you have cleaned or replaced the air filter, for a suitable indication about the air filter. • For the air filter cleaning, see the section "Air filter" (U68). |

(continued on next page)

OPTION Menu (continued)

| Item | Description |
|-------------------------|---|
| <p>MY BUTTON</p> | <p>This item is to assign one of the following function to MY BUTTON 1 and 2 on the remote control (📄6). Choose 1 or 2 on the MY BUTTON menu using the ◀/▶ button first. Then using the ▲/▼ buttons sets one of the following functions to the chosen button.</p> <ul style="list-style-type: none"> • RGB1: Sets port to RGB1. • RGB2: Sets port to RGB2. • HDMI: Sets port to HDMI. • COMPONENT: Sets port to COMPONENT (Y, Cb/Pb, Cr/Pr). • S-VIDEO: Sets port to S-VIDEO. • VIDEO: Sets port to VIDEO. • INFORMATION: Displays the INPUT -INFORMATION- (📄51) or NETWORK -INFORMATION- (📄64) or nothing. • AUTO KEYSTONE [] : Performs automatic keystone distortion correction (📄38). • MY MEMORY: Loads one of adjustment data stored (📄31). When more than one data are saved, the adjustment changes every time the MY BUTTON is pushed. When no data is saved in memory, the dialog "No saved data" appears. When the current adjustment is not saved to memory, the dialog as shown in the right appears. If you want to keep the current adjustment, please press the ◀ button to quit. Otherwise loading a data will overwrite the current adjusted condition. • ACTIVE IRIS: Changes the active iris mode. • PICTURE MODE: Changes the PICTURE MODE (📄27). • FILTER RESET: Displays the filter time reset confirmation dialogue (📄48). • AV MUTE : Turns the picture and audio on/off. • TEMPLATE: Makes the template pattern selected to the TEMPLATE item (📄46) appear or disappear. • PbyP SWAP: Swaps the picture of right side with left side in the PbyP mode (📄25). • MY IMAGE: Displays the MY IMAGE menu (📄63). |
| <p>MY SOURCE</p> | <p>This item is to assign an input signals to MY SOURCE / DOC. CAMERA button on the remote control (📄6, 19). Using the ▲/▼ buttons sets one of the following input signal.</p> <p>↔ RGB1 ↔ RGB2 ↔ HDMI ↔ VIDEO ↔ S-VIDEO ↔ COMPONENT</p>  |
| <p>SERVICE</p> | <p>Selecting this item displays the SERVICE menu. Select an item using the ▲/▼ buttons, and press the ▶ button or the ENTER button on the remote control to execute the item.</p> <p>↔ FAN SPEED ↔ AUTO ADJUST ↔ FILTER MESSAGE ↔ FACTORY RESET ↔ INFORMATION ↔ REMOTE FREQ. ↔ REMOTE RECEIV. ↔ KEY LOCK</p> <p>FAN SPEED Using the ▲/▼ buttons switches the rotation speed of the cooling fans. The HIGH is the mode for use at highlands etc. Note that the projector is noisier when the HIGH is selected.</p> <p>HIGH ↔ NORMAL</p>  |

(continued on next page)



OPTION Menu (continued)

| Item | Description |
|---------------------------------------|---|
| <p>SERVICE (continued)</p> | <p>AUTO ADJUST Using the ▲/▼ buttons to select one of the mode. When the DISABLE is selected, the automatic adjustment feature is disabled.</p> <p>FINE ⇄ FAST ⇄ DISABLE</p>  <p>FINE: Finer tuning including H.SIZE adjustment. FAST: Faster tuning, setting H.SIZE to prearranged data for the input signal.</p> <ul style="list-style-type: none"> Depending on conditions, such as input image, signal cable to the projector, environment around the projector, etc., the automatic adjustment may not work correctly. In such a case, please choose DISABLE to disable the automatic adjustment, and make adjustment manually. |
| | <p>FILTER MESSAGE Use the ▲/▼ button to set the timer for the interval to show the message for cleaning up the air filter.</p> <p>500h ⇄ 1000h ⇄ 1500h ⇄ 2000h ⇄ TURN OFF</p> <p>After choosing an item except TURN OFF, the message “REMINDER *** HRS PASSED AFTER THE LAST FILTER CHECK” will appear after the timer reaches the interval time set by this feature (🔧71).</p> <p>When the TURN OFF is chosen, the message will not appear. Utilize this feature to keep the air filter clean, setting the suitable time according to your environment of this projector.</p> <ul style="list-style-type: none"> Please check and clean the air filter periodically, even if there is no message. If the air filter becomes to be blocked by dust or others, the internal temperature will rise, which could cause malfunction, or reduce the lifetime of the projector. Please be careful with the operating environment of the projector and the condition of the air filter. |

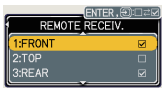

(continued on next page)

OPTION Menu (continued)

| Item | Description |
|---------------------------------------|--|
| <p>SERVICE (continued)</p> | <p>KEY LOCK Using the ▲/▼ buttons turns on/off the key lock feature. When TURN ON is selected, the buttons on the projector except the STANDBY/ON button are locked. TURN ON ⇔ TURN OFF</p> <ul style="list-style-type: none"> • Please use to avoid a mischief and touching accidentally. This function does not have any effect on the remote control. <p>REMOTE RECEIV. (1) Select a remote sensor using the ▲/▼ button. 1:FRONT ⇔ 2:TOP ⇔ 3:REAR</p>  <p>(2) Switch it using the ENTER or INPUT button. <input type="checkbox"/> (off) ⇔ <input checked="" type="checkbox"/> (on)</p> <ul style="list-style-type: none"> • A sensor cannot be turned off when the other two are off. Always at least one sensor is on. <p>REMOTE FREQ. Use the ▲/▼ button to change the Projector's remote sensor setting (📖14). 1:NORMAL ⇔ 2:HIG</p>  <p>Items with a checkmark are on. The factory default setting is for both 1:NORMAL and 2:HIG to be on. If the remote control does not function correctly, set the this to either only 1 or only 2 as described in Remote Control Settings (📖14).</p> <p>Neither can be turned off at the same time.</p> <p>INFORMATION Selecting this item displays a dialog titled "INPUT-INFORMATION-". It shows the information about the current input.</p>  <ul style="list-style-type: none"> • The "FRAME LOCK" message on the dialog means the frame lock function is working. • The "SCART RGB" message means the COMPONENT port is working as a SCART RGB input port. Please refer to the COMPONENT item in INPUT Menu (📖35). • This item can't be selected for no signal and sync out. • When the MY TEXT DISPLAY is set to TURN ON, the MY TEXT is displayed together with the input information in the INPUT-INFORMATION- box. (📖58) <p>FACTORY RESET Selecting RESET using the button ▲ performs this function. By this function, all the items in all of menus will collectively return to the initial setting. Note that the items LAMP TIME, FILTER TIME, LANGUAGE, SECURITY and NETWORK settings are not reset. RESET ⇔ CANCEL</p> |

(continued on next page)

OPTION Menu (continued)

| Item | Description |
|---------------------------------------|--|
| <p align="center">SECURITY</p> | <p>This projector is equipped with security functions. User registration is required before using the security functions. Please contact your local dealer.</p> <p>1. Using Security Features</p> <p>1.1 Inputting the PASSWORD</p> <p>1.1-1 Use the ▲/▼ buttons on the OPTION Menu to select SECURITY and press the ► button. The ENTER PASSWORD box will be displayed. The factory default PASSWORD is 4304. This PASSWORD can be changed (1.2 Changing the PASSWORD).</p> <ul style="list-style-type: none"> It is strongly recommended the factory default PASSWORD to be changed as soon as possible. <p>1.1-2 Use the ▲/▼/◀/▶ buttons to enter the registered PASSWORD. Move the cursor to the right side of the ENTER PASSWORD BOX and press the ► button to display the SECURITY menu. If an incorrect PASSWORD is input, the ENTER PASSWORD BOX will be displayed again. If incorrect PASSWORD is input 3 times, the projector will turn off. Afterwards the projector will turn off every time an incorrect PASSWORD is input.</p> |
| | <p>1.2 Changing the PASSWORD</p> <p>1.2-1 Use the ▲/▼ buttons on the SECURITY menu to select SECURITY PASSWORD CHANGE and press the ► button to display the ENTER NEW PASSWORD BOX.</p> |
| | <p>1.2-2 Use the ▲/▼/◀/▶ buttons to enter the new PASSWORD.</p> |
| | <p>1.2-3 Move the cursor to the right side of the ENTER NEW PASSWORD BOX and press the ► button to display the NEW PASSWORD AGAIN BOX, enter the same PASSWORD again.</p> |
| | <p>1.2-4 Move the cursor to the right side of the NEW PASSWORD AGAIN BOX and press the ► button and the NOTE NEW PASSWORD BOX will be displayed for about 20 seconds, please make note of the PASSWORD during this time. Pressing the ENTER button on the remote control or INPUT button on the projector will close the NOTE NEW PASSWORD BOX.</p> <ul style="list-style-type: none"> Please do not forget your PASSWORD. |

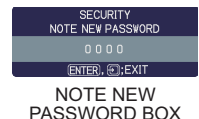
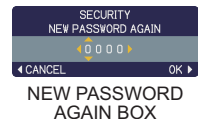
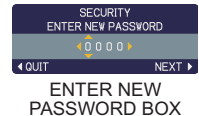
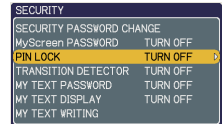

(continued on next page)

OPTION Menu (continued)

| Item | Description |
|------------------------------------|---|
| <p>SECURITY (continued)</p> | <p>1.3 If you have forgotten your PASSWORD</p> <p>1.3-1 Follow the procedure in 1.1-1 to display the ENTER PASSWORD BOX.</p> <p>1.3-2 While the ENTER PASSWORD BOX is displayed, press and hold the RESET button on the remote control for about 3 seconds or press and hold the INPUT button for 3 seconds while pressing the ► button on the projector. The 10 digit Inquiring Code will be displayed.</p> <ul style="list-style-type: none"> • If there is no key input for about 55 seconds while the Inquiring Code is displayed, the menu will close. If necessary, repeat the process from 1.3-1. <p>1.3-3 Contact your dealer with the 10 digit Inquiring Code. Your PASSWORD will be sent after your user registration information is confirmed.</p> |
| | <p>2. Using the MyScreen PASSWORD Function</p> <p>The MyScreen PASSWORD function can be used to prohibit access to the MyScreen function and prevent the currently registered MyScreen image from being overwritten.</p> <p>2.1 Turning on the MyScreen PASSWORD Function</p> <p>2.1-1 Use the ▲/▼ buttons on the SECURITY menu to select MyScreen PASSWORD and press the ► button to display the MyScreen PASSWORD on/off menu.</p> |
| | <p>2.2 Setting the PASSWORD</p> <p>2.2-1 Display the MyScreen on/off menu using the procedure in 2.1-1.</p> <p>2.2-2 Use the ▲/▼ buttons on the MyScreen PASSWORD on/off menu to select TURN ON. The ENTER PASSWORD BOX (small) will be displayed.</p> <p>2.2-3 Use the ▲/▼/◀/▶ buttons to enter the PASSWORD. Move the cursor to the right side of the ENTER PASSWORD BOX (small) and press the ► button to display the PASSWORD AGAIN BOX, enter the same PASSWORD again.</p> |



Inquiring Code (PASSWORD)



MyScreen PASSWORD on/off menu



ENTER PASSWORD BOX (small)

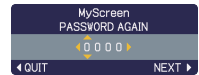

PASSWORD AGAIN BOX

(continued on next page)

OPTION Menu (continued)

| Item | Description |
|------------------------------------|--|
| <p>SECURITY (continued)</p> | <p>2.2-4 Move the cursor to the right side of the PASSWORD AGAIN BOX and press the ► button to display the PASSWORD for about 20 seconds, please make note of the PASSWORD during this time.</p> <p>Pressing the ENTER button on the remote control or INPUT button on the projector will return to MyScreen PASS WORD on/off menu.</p> <p>When a PASSWORD is set for MyScreen:</p> <ul style="list-style-type: none"> • The MyScreen registration function (and menu) will be unavailable. • The MyScreen Lock menu will be unavailable. • The START UP setting will be locked on MyScreen (and the menu will be unavailable). <p>Turning the MyScreen PASSWORD off will allow normal operation of these functions.</p> <ul style="list-style-type: none"> • Please do not forget your MyScreen PASSWORD. <p>2.3 Turning the PASSWORD off</p> <p>2.3-1 Follow the procedure in 2.1-1 to display the MyScreen PASSWORD on/off menu.</p> <p>2.3-2 Select TURN OFF to display the ENTER PASSWORD BOX (large). Enter the registered PASSWORD and the screen will return to the MyScreen on/off menu.</p> <p>If an incorrect PASSWORD is input, the menu will close. If necessary, repeat the process from 2.3-1.</p> |
| | <p>2.4 If you have forgotten your PASSWORD</p> <p>2.4-1 Follow the procedure in 2.1-1 to display the MyScreen PASSWORD on/off menu.</p> <p>2.4-2 Select TURN OFF to display the ENTER PASSWORD BOX (large). The 10 digit Inquiring Code will be displayed inside the BOX.</p> <p>2.4-3 Contact your dealer with the 10 digit Inquiring Code. Your PASSWORD will be sent after your user registration information is confirmed.</p> <p>3. Using the PIN LOCK Function</p> <p>PIN LOCK is a function which prevents the projector from being used unless a registered Code is input.</p> <p>3.1 Registering the PIN Code</p> <p>3.1-1 Use the ▲/▼ buttons on the SECURITY menu to select PIN LOCK and press the ► button or the ENTER button to display the PIN LOCK on/off menu.</p> <p>3.1-2 Use the ▲/▼ buttons on the PIN LOCK on/off menu to select TURN ON and the PIN BOX will be displayed.</p> |

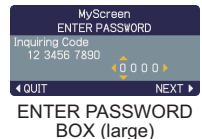

(continued on next page)



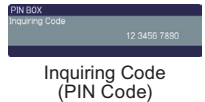

OPTION Menu (continued)

| Item | Description |
|------------------------------------|---|
| <p>SECURITY (continued)</p> | <p>3.1-3 Input a 4 part PIN Code using the ▲/▼/◀/▶/RGB and INPUT buttons. The PIN CODE AGAIN BOX will appear. Reenter the same PIN Code. This will complete the PIN Code registration.</p> <ul style="list-style-type: none"> • If there is no key input for about 55 seconds while the PIN BOX or the PIN CODE AGAIN BOX is displayed, the menu will close. If necessary, repeat the process from 3.1-1. <p>Afterwards, anytime the projector is restarted after the power switch is turned off the PIN BOX will be displayed. Enter the registered PIN Code. The projector can be used after entering the registered PIN Code. If an incorrect PIN Code is input, the PIN BOX will be displayed again. If an incorrect PIN Code is input 3 times, the projector will turn off. Afterwards the projector will turn off every time an incorrect PIN Code is input. The projector will also turn off if there is no key input for about 5 minutes while the PIN BOX is displayed. This function will activate only when the projector is started after the power switch was turned off.</p> <ul style="list-style-type: none"> • Please do not forget your PIN Code. <p>3.2 Turning Off the PIN LOCK Function</p> <p>3.2-1 Follow the procedure in 3.1-1 to display the PIN LOCK on/off menu. Use the ▲/▼ buttons to select TURN OFF and the PIN BOX will be displayed. Enter the registered PIN Code to turn the PIN LOCK function off. If an incorrect PASSWORD is input 3 times, the menu will close.</p> |
| | <p>3.3 If you have forgotten your PIN Code</p> <p>3.3-1 While the PIN BOX is displayed, press and hold the RESET button for three seconds or press and hold the INPUT button for 3 seconds while pressing the ▶ button on the projector.</p> <ul style="list-style-type: none"> • If there is no key input for about 5 minutes while the Inquiring Code is displayed, the projector will turn off. <p>3.3-2 Contact your dealer with the 10 digit Inquiring Code. Your PASSWORD will be sent after your user registration information is confirmed.</p> |



(continued on next page)

OPTION Menu (continued)



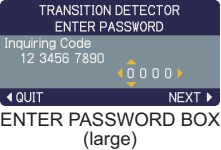
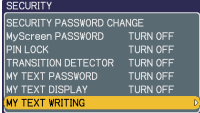
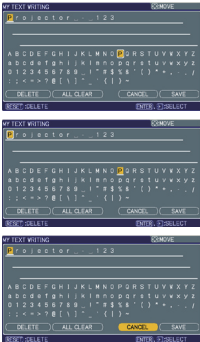

| Item | Description |
|---|---|
| <p>SECURITY (continued)</p> | <p>4. Using the Transition Detector Function</p> <p>While the Transition Detector function is ON, when power switch is started to supply to the projector, it might react as below.</p> <ul style="list-style-type: none"> • Transition Detector alarm shown below might appear on screen, if the projector has been moved or re-installed. • Transition Detector alarm might appear on screen, if the MIRROR setting has been changed. • Keystone adjustment feature and the adjustment of the PERFECT FIT have been prohibited as long as the Transition Detector function is on. <p>4.1 Turning On the Transition Detector Function</p> <p>4.1-1 Use the ▲/▼ buttons on the SECURITY menu to select Transition Detector and press the ► or the ENTER button to display the Transition Detector on/off menu.</p>  <p>Transition Detector on/off menu</p> <ul style="list-style-type: none"> • This feature may not function properly if the projector is not in a stable position when TURN ON is selected. <p>4.1-2 If this function is set to TURN ON when the vertical angle of the projector or mirror setting at which the projector is turned on is different than the previously recorded, the Transition Detector Alarm will be displayed and the projector will not display the input signal.</p>  <p>Transition Detector Alarm</p> <p>Set the Transition Detector off in the SECURITY menu to display the input signal. If the Transition Detector ALARM is displayed for about 5 minutes, the lamp will turn off.</p> <p>This function will activate only when the projector is started after the power switch was turned off.</p> <p>4.2 Setting the Transition Detector PASSWORD</p> <p>4.2-1 Use the ▲/▼ buttons on the SECURITY menu to select Transition Detector and press the ► or the ENTER button to display the Transition Detector on/off menu.</p> <p>4.2-2 Use the ▲/▼ buttons on the Transition Detector on/off menu to select TURN ON. The ENTER PASSWORD BOX (small) will be displayed.</p>  <p>ENTER PASSWORD BOX (small)</p> <p>4.2-3 Use the ▲/▼/◀/▶ buttons to enter a PASSWORD. Move the cursor to the right side of the ENTER PASSWORD BOX (small) and press the ► button to display the PASSWORD AGAIN BOX, enter the same PASSWORD again.</p>  <p>PASSWORD AGAIN BOX</p> <p>4.2-4 Move the cursor to the right side of the PASSWORD AGAIN BOX and press the ► button to display the PASSWORD for about 20 seconds, please make note of the PASSWORD during this time.</p>  <p>NOTE PASSWORD BOX</p> <p>Pressing the ENTER button on the remote control or the INPUT button on the projector will return to the Transition Detector on/off menu.</p> <ul style="list-style-type: none"> • Please do not forget your Transition Detector PASSWORD. |

(continued on next page)

OPTION Menu (continued)

| Item | Description |
|---|--|
| <p>SECURITY (continued)</p> | <p>4.3 Setting the Transition Detector off</p> <p>4.3-1 Follow the procedure in 4.1-1 to display the Transition Detector on/off menu.</p> <p>4.3-2 Select TURN OFF to display the ENTER PASSWORD BOX (large). Enter the registered PASSWORD and the screen will return to the Transition Detector on/off menu.</p> <p>If an incorrect PASSWORD is input, the menu will close. If necessary, repeat the process from 4.3-1.</p> <p>4.4 If you have forgotten your PASSWORD</p> <p>4.4-1 Follow the procedure in 4.1-1 to display the Transition Detector on/off menu.</p> <p>4.4-2 Select TURN OFF to display the ENTER PASSWORD BOX (large). The 10 digit Inquiring Code will be displayed inside the BOX.</p> <p>4.4-3 Contact your dealer with the 10 digit Inquiring Code. Your PASSWORD will be sent after your user registration information is confirmed.</p> |
| |  <p>TRANSITION DETECTOR ENTER PASSWORD Inquiring Code 12 3456 7890 0 0 0 0 ◀ QUIT NEXT ▶ ENTER PASSWORD BOX (large)</p> |
| | <p>5. Using the MY TEXT PASSWORD function</p> <p>This item allows you to display your own message (MY TEXT) on the START UP screen and INPUT-INFORMATION. It can be protected by a password to prevent it from being overwritten.</p> |
| | <p>5.1 Writing the MY TEXT</p> <p>(1) Use the ▲/▼ buttons on the SECURITY menu to select the MY TEXT WRITING menu and press the ► button. The MY TEXT WRITING dialog will be displayed.</p> <p>(2) The current MY TEXT will be displayed on the first 3 lines. If not yet written, the lines will be blank. Use the ▲/▼/◀/▶ buttons and the ENTER or INPUT button to select and enter characters. The RESET button can be used to erase 1 character at a time. Also if you move the cursor to DELETE or ALL CLEAR on screen and push the ENTER or INPUT button, 1 character or all characters will be erased. The MY TEXT can be input up to 24 characters on each line.</p> <p>(3) To change an already inserted character, press the ▲/▼ button to move the cursor to one of the first 3 lines, and use the ◀/▶ buttons to move the cursor on the character to be changed. After pressing the ENTER or INPUT button, the character is selected. Then, follow the same procedure as described at the item (2) above.</p> <p>(4) To finish entering text, move the cursor to the SAVE on screen and press the ENTER or INPUT button. To revert to the previous MY TEXT without saving changes, move the cursor to the CANCEL on screen and press the ENTER or INPUT button.</p> <ul style="list-style-type: none"> The MY TEXT WRITING function is available only when the MY TEXT PASSWORD function is set to TURN OFF. |
| |  <p>SECURITY SECURITY PASSWORD CHANGE MyScreen PASSWORD TURN OFF PIN LOCK TURN OFF TRANSITION DETECTOR TURN OFF MY TEXT PASSWORD TURN OFF MY TEXT DISPLAY TURN OFF MY TEXT WRITING 0</p> |
|  <p>MY TEXT WRITING ENHANCE 0 1 2 3 4 5 6 7 8 9 A B C D E F G H I J K L M N O P Q R S T U V W X Y Z 0 1 2 3 4 5 6 7 8 9 * # \$ % & ' () + - = / : ; < - > * () + - = / ◀ DELETE ALL CLEAR CANCEL SAVE ENTER 0/DELETE</p> <p>MY TEXT WRITING ENHANCE 0 1 2 3 4 5 6 7 8 9 A B C D E F G H I J K L M N O P Q R S T U V W X Y Z 0 1 2 3 4 5 6 7 8 9 * # \$ % & ' () + - = / : ; < - > * () + - = / ◀ DELETE ALL CLEAR CANCEL SAVE ENTER 0/DELETE</p> <p>MY TEXT WRITING ENHANCE 0 1 2 3 4 5 6 7 8 9 A B C D E F G H I J K L M N O P Q R S T U V W X Y Z 0 1 2 3 4 5 6 7 8 9 * # \$ % & ' () + - = / : ; < - > * () + - = / ◀ DELETE ALL CLEAR CANCEL SAVE ENTER 0/DELETE</p> | |

OPTION Menu (continued)

| Item | Description |
|--|--|
| <p>SECURITY (continued)</p> | <p>5.2 Displaying the MY TEXT</p> <p>(1) Use the ▲/▼ buttons on the SECURITY menu to select the MY TEXT DISPLAY menu and press the ► button to display the MY TEXT DISPLAY on/off menu.</p>  <p>MY TEXT DISPLAY on/off menu</p> |
| | <p>(2) Use the ▲/▼ buttons on the MY TEXT DISPLAY on/off menu to select on or off.</p> <p>TURN ON ⇔ TURN OFF</p> <p>When it is set TURN ON, the MY TEXT will be displayed on the START UP screen and the INPUT-INFORMATION- when the INFORMATION on the SERVICE menu is chosen.</p> <ul style="list-style-type: none"> • This function is available only when the MY TEXT PASSWORD function is set to the TURN OFF. |
| | <p>5.3 Turning on the MY TEXT PASSWORD</p> <p>The MY TEXT PASSWORD function can prevent the MY TEXT from being overwritten.</p> |
| | <p>5.3-1 Turning on the MY TEXT PASSWORD function</p> <p>(1) Use the ▲/▼ buttons on the SECURITY menu to select the MY TEXT PASSWORD menu and press the ► button to display the MY TEXT PASSWORD on/off menu.</p>  <p>MY TEXT PASSWORD on/off menu</p> |
| | <p>5.3-2 Setting the MY TEXT PASSWORD</p> <p>(1) Display the MY TEXT PASSWORD on/off menu using the procedure in 5.3-1</p> |
| <p>(2) Use the ▲/▼ buttons on the MY TEXT PASSWORD menu to select TURN ON. The ENTER PASSWORD BOX (small) will be displayed.</p>  <p>ENTER PASSWORD BOX (small)</p> | |
| <p>(3) Use the ▲/▼/◀/▶ buttons to enter the PASSWORD. Move the cursor to the right side of the ENTER PASSWORD BOX (small) and press the ► button to display the PASSWORD AGAIN BOX, and then enter the same PASSWORD again.</p>  <p>PASSWORD AGAIN BOX</p> | |
| <p>(4) Move the cursor to the right side of the PASSWORD AGAIN BOX and press ► button to display the PASSWORD for about 20 seconds, then please make note of the PASSWORD during this time.</p>  <p>NOTE PASSWORD BOX</p> | |
| <p>Pressing the ENTER button on the remote control or INPUT button on the projector will return to the MY TEXT PASSWORD on/off menu. When the PASSWORD is set for the MY TEXT;</p> <ul style="list-style-type: none"> • The MY TEXT DISPLAY menu will be unavailable, which can prohibit changing the DISPLAY setting. • The MY TEXT WRITING menu will be unavailable, which can prevent the MY TEXT from being overwritten. | |

(continued on next page)

OPTION Menu (continued)

| Item | Description |
|------------------------------------|--|
| <p>SECURITY (continued)</p> | <p>5.3-3 Turning the MY TEXT PASSWORD off</p> <p>(1) Follow the procedure in 5.3-1 to display the MY TEXT PASSWORD on/off menu.</p> <p>(2) Select TURN OFF to display the ENTER PASSWORD BOX (large). Enter the registered PASSWORD and the screen will return to the MY TEXT PASSWORD on/off menu.</p> <p>If an incorrect PASSWORD is input, the menu will close. If necessary, repeat the process from 5.3-3(1)</p> <p>5.3.4 If you have forgotten your PASSWORD.</p> <p>(1) Follow the procedure in 5.3-1 to display the MY TEXT PASSWORD on/off menu.</p> <p>(2) Select TURN OFF to display the ENTER PASSWORD BOX (large). The 10 digit inquiring code will be displayed inside the box.</p> <p>(3) Contact your dealer with the 10 digit inquiring code. Your PASSWORD will be sent after your user registration information is confirmed.</p> |

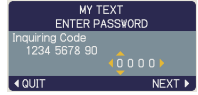

ENTER PASSWORD BOX (large)

NETWORK Menu

NETWORK Menu

Remember that incorrect network settings on this projector may cause trouble on the network. Be sure to consult with your network administrator before connecting to an existing access point on your network.

Select "NETWORK" from the main menu to access the following functions.



Select an item using the ▲/▼ cursor buttons on the projector or remote control, and press the ► cursor button on the projector or remote control, or **ENTER** button on the remote control to execute the item. Then perform it according to the following table.

See the User's Manual - Network Guide for details of NETWORK operation.



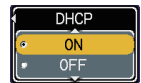
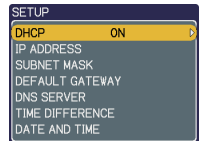

NOTE • If you are not utilizing SNTP ([Date/Time Settings of the User's Manual \(detailed\) - Network Guide](#)), then you must set the DATE AND TIME during the initial installation.

| Item | Description | |
|--------------|--|---|
| SETUP | Selecting this item displays the SETUP Menu for the network. Use the ▲/▼ buttons to select an item, and the ► or ENTER button on the remote control to perform the item. | |
| | DHCP (Dynamic Host Configuration Protocol) | Use the ▲/▼ buttons to turn DHCP on/off. ON ⇔ OFF Select OFF when the network does not have DHCP enabled. <ul style="list-style-type: none"> • When the "DHCP" setting changes to "ON", it takes a little time to obtain IP address from DHCP server. • Auto IP function will be assigned an IP address if the projector could not obtain an IP address from server even if DHCP is "ON". |

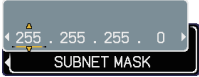

(continued on next page)

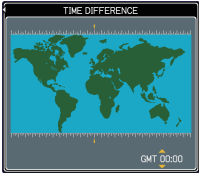
NETWORK Menu (continued)

| Item | Description | |
|-----------------------------|------------------------|---|
| SETUP (continued) | IP ADDRESS | <p>Use the ▲/▼/◀/▶ buttons to enter the IP ADDRESS. This function can only be used when DHCP is set to OFF.</p>  <ul style="list-style-type: none"> • The IP ADDRESS is the number that identifies this projector on the network. You cannot have two devices with the same IP ADDRESS on the same network. • The IP ADDRESS “0.0.0.0” is prohibited. |
| | SUBNET MASK | <p>Use the ▲/▼/◀/▶ buttons to enter the same SUBNET MASK used by your PC. This function can only be used when DHCP is set to OFF.</p>  <ul style="list-style-type: none"> • The SUBNET MASK “0.0.0.0” is prohibited. |
| | DEFAULT GATEWAY | <p>Use the ▲/▼/◀/▶ buttons to enter the DEFAULT GATEWAY (a node on a computer network that serves as an access point to another network) address. This function can only be used when DHCP is set to OFF.</p>  |
| | DNS SERVER | <p>Use the ▲/▼/◀/▶ buttons to input the DNS server address. The DNS server is a system to control domain names and IP addresses on the Network.</p>  |
| | TIME DIFFERENCE | <p>Use the ▲/▼ buttons to enter the TIME DIFFERENCE. Set the same TIME DIFFERENCE as the one set on your PC. If unsure, consult your IT manager. Use the ◀ button to return to the menu after setting the TIME DIFFERENCE.</p>  |
| | DATE AND TIME | <p>Use the ▲/▼/◀/▶ buttons to enter the Year (last two digits), Month, Date, Hour and Minute.</p>  <ul style="list-style-type: none"> • The projector will override this setting and retrieve DATE AND TIME information from the Time server when SNTP is enabled. (📖 Date/Time Settings of the User’s Manual (detailed) - Network Guide) |

(continued on next page)

NETWORK Menu (continued)

| Item | Description |
|------------------------------|---|
| <p>PROJECTOR NAME</p> | <p>(1) Use the ▲/▼ buttons on the NETWORK Menu to select the PROJECTOR NAME menu and press the ► button. The PROJECTOR NAME dialog will be displayed.</p> <p>(2) The current PROJECTOR NAME will be displayed on the first 3 lines. If not yet written, the lines will be blank. Use the ▲/▼/◀/▶ buttons and the ENTER or INPUT button to select and enter characters. The RESET button can be used to erase 1 character at a time. Also if you move the cursor to DELETE or ALL CLEAR on screen and push the ENTER or INPUT button, 1 character or all characters will be erased. The PROJECTOR NAME can be input up to 64 characters.</p> <p>(3) To change an already inserted character, press the ▲/▼ button to move the cursor to one of the first 3 lines, and use the ◀/▶ buttons to move the cursor on the character to be changed. After pressing the ENTER or INPUT button, the character is selected. Then, follow the same procedure as described at the item (2) above.</p> <p>(4) To finish entering text, move the cursor to the SAVE on screen and press the ENTER or INPUT button. To revert to the previous PROJECTOR NAME without saving changes, move the cursor to the CANCEL on screen and press the ENTER or INPUT button.</p> |

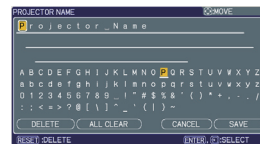
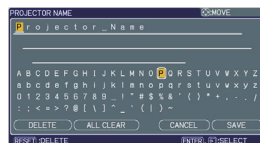
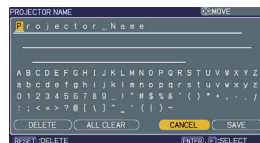

(continued on next page)

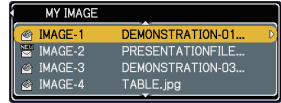

NETWORK Menu (continued)

| Item | Description |
|------------------------|--|
| <p>MY IMAGE</p> | <p>Selecting this item displays the MY IMAGE menu.</p> <p>The application software “PImage” is required to store image(s) into the projector.</p> <p>Use the ▲/▼ buttons to select an item which is a still image by the MY IMAGE (MY IMAGE (Still Image Transfer) Display of the User’s Manual (detailed) - Network Guide) and the ► or ENTER button to display the image.</p> <ul style="list-style-type: none"> • The item without image stored cannot be selected. • The image names are each displayed in 16 characters or less. <p>To switch the image displayed Use the ▲/▼ buttons.</p> <p>To return to the menu Press the ◀ or ESC button on the remote control.</p> <p>To erase the image displayed and its source file in the projector.</p> <p>(1) Press the RESET button on the remote control while displaying an image to display the MY IMAGE RESET menu.</p> <p>(2) Press the ENTER button on the remote control or the INPUT button on the projector to perform to erase. To stop erasing, press the ESC button on the remote control or the ◀ button on the projector.</p> |

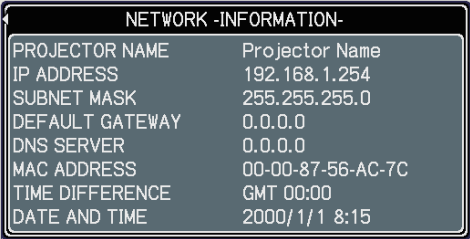

(continued on next page)

NETWORK Menu (continued)

| Item | Description |
|---------------------------|--|
| <p>INFORMATION</p> | <p>Selecting this item displays the NETWORK -INFORMATION- dialog for confirming the network settings.</p>  <ul style="list-style-type: none"> • The PROJECTOR NAME is displayed. • Nothing (blank) is shown in the “PROJECTOR NAME” field until you setup the item (62). • When the voltage level of the battery for the built in clock decreases, the set time may become incorrect even though accurate date and time are input. Replace the battery suitably (69). • IP ADDRESS, SUBNET MASK and DEFAULT GATEWAY indicate “0.0.0.0” when DHCP is ON and the projector has not gotten address from DHCP server. |
| <p>SERVICE</p> | <p>Executing this item restarts and initializes the network functions. Choose the RESTART using the button ►.</p>  <p>Then use the button ▲ to execute.</p>  <p>Network will be once cut off when choose restart. If DHCP is selected on, IP address may be changed. After selecting RESTART, NETWORK Menu may not be controlled approx. 30 seconds.</p> |

C.C. (Closed Caption) Menu

The closed caption setting can be changed through C.C. Menu in the advance menu. Please select the item that you will change using ▲/▼ cursor buttons.

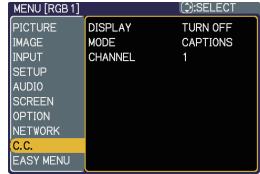

- The C.C. (Closed Caption) is the function that displays a transcript or dialog of the audio portion of a video, files or other presentation or other relevant sounds. It is required to have NTSC format video or 480i@60 format component video source supporting C.C. feature to utilize this function.

It may not work properly, depending on equipment or signal source. In this case, please turn off the Closed Caption.

| Item | Description |
|-----------------------|--|
| <p>DISPLAY</p> | <p>Select Closed Caption DISPLAY setting from following options using ▲/▼ buttons.</p> <p>TURN OFF ⇔ TURN ON ⇔ AUTO</p> <p style="text-align: center;">↑—————↑</p> <p>TURN OFF: Closed Caption is OFF TURN ON: Closed Caption is ON AUTO: Closed Caption automatically displays when the volume is muted.</p> <ul style="list-style-type: none"> • The caption is not displayed when the OSD menu is active. • The Closed Caption is the function to display the dialogue, narration, and / or sound effects of a television program or other video sources. The Closed Caption availability is depending upon broadcaster and/or content. |
| <p>MODE</p> | <p>Select Closed Caption MODE setting from following options using ▲/▼ buttons.</p> <p>CAPTIONS ⇔ TEXT</p> <p>CAPTIONS: Display Closed Caption TEXT: Display Text data, which is for additional information such as news reports or a TV program guide. The information covers the entire screen. Not all of the C.C. program has Text information.</p> |
| <p>CHANNEL</p> | <p>Select Closed Caption CHANNEL from following options using ▲/▼ buttons.</p> <p>4 ⇔ 3 ⇔ 2 ⇔ 1</p> <p style="text-align: center;">↑—————↑</p> <p>1: Channel 1, primary channel / language 2: Channel 2 3: Channel 3 4: Channel 4</p> <p>The channel data may vary, depending on the content. Some channel might be used for secondary language or empty.</p> |

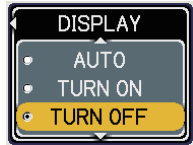

Maintenance

Lamp

A lamp has finite product life. Using the lamp for long periods of time could cause the pictures darker or the color tone poor. Note that each lamp has a different lifetime, and some may burst or burn out soon after you start using them.

Preparation of a new lamp and early replacement are recommended. To prepare a new lamp, contact your dealer and tell the lamp type number.

Type number = 003-120457-01 (DT00873)

Replacing the lamp

1. Turn the projector off, and unplug the power cord. Allow the projector to cool for at least 45 minutes.
2. Prepare a new lamp. If the projector is mounted on a ceiling, or if the lamp has broken, also ask the dealer to replace the lamp.

In case of replacement by yourself,

3. Loosen the screw (marked by arrow) of the lamp cover and then slide the lamp cover to the side to remove it.
4. Loosen the 3 screws (marked by arrow) of the lamp, and slowly pick up the lamp by the handles.
5. Insert the new lamp, and retighten firmly the 3 screws of the lamp that are loosened in the previous process to lock it in place.
6. Slide the lamp cover back in place and firmly fasten the screw of the lamp cover.
7. Turn the projector on and reset the lamp time using the LAMP TIME item in the OPTION Menu (48).
 - (1) Press the **MENU** button to display a menu.
 - (2) Point at the "Go to Advanced Menu ..." in the menu using the **▼/▲** button, then press the **▶** button.
 - (3) Point at the "OPTION" in the left column of the menu using the **▼/▲** button, then press the **▶** button.
 - (4) Point at the "LAMP TIME" using the **▼/▲** button, then press the **▶** button. A dialog will appear.
 - (5) Press the **▲** button to select "RESET" on the dialog. It performs resetting the lamp time.

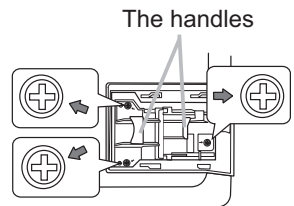
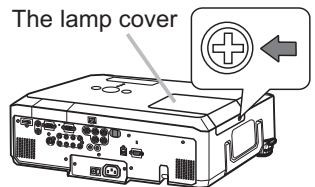

NOTE • Please reset the lamp time only when you have replaced the lamp, for a suitable indication about the lamp.

Lamp (continued)

Lamp warning

 HIGH VOLTAGE  HIGH TEMPERATURE  HIGH PRESSURE

⚠ WARNING ▶ The projector uses a high-pressure mercury glass lamp. The lamp can break with a loud bang, or burn out, if jolted or scratched, handled while hot, or worn over time. Note that each lamp has a different lifetime, and some may burst or burn out soon after you start using them. In addition, if the bulb bursts, it is possible for shards of glass to fly into the lamp housing, and for gas containing mercury and dust containing fine particles of glass to escape from the projector's vent holes.

▶ **About disposal of a lamp:** This product contains a mercury lamp; do not put it in a trash. Dispose of it in accordance with environmental laws.

- For lamp recycling, go to www.lamprecycle.org (in the US).
- For product disposal, contact your local government agency or www.eiae.org (in the US) or www.epsc.ca (in Canada).

For more information, call your dealer.



Disconnect the plug from the power outlet

- If the lamp should break (it will make a loud bang when it does), unplug the power cord from the outlet, and make sure to request a replacement lamp from your local dealer. Note that shards of glass could damage the projector's internals, or cause injury during handling, so please do not try to clean the projector or replace the lamp yourself.
- If the lamp should break (it will make a loud bang when it does), ventilate the room well, and make sure not to inhale the gas or fine particles that come out from the projector's vent holes, and not to get them into your eyes or mouth.
- Before replacing the lamp, turn the projector off and unplug the power cord, then wait at least 45 minutes for the lamp to cool sufficiently. Handling the lamp while hot can cause burns, as well as damaging the lamp.



- Never unscrew except the appointed (marked by an arrow) screws.
- Do not open the lamp cover while the projector is suspended from a ceiling. This is dangerous, since if the lamp's bulb has broken, the shards will fall out when the cover is opened. In addition, working in high places is dangerous, so ask your local dealer to have the lamp replaced even if the bulb is not broken.
- Do not use the projector with the lamp cover removed. At the lamp replacing, make sure that the screws are screwed in firmly. Loose screws could result in damage or injury.



- Use only the lamp of the specified type. Use of a lamp that does not meet the lamp specifications for this model could cause a fire, damage or shorten the life of this product.
- If the lamp breaks soon after the first time it is used, it is possible that there are electrical problems elsewhere besides the lamp. If this happens, contact your local dealer or a service representative.
- Handle with care: jolting or scratching could cause the lamp bulb to burst during use.
- Using the lamp for long periods of time, could cause it dark, not to light up or to burst. When the pictures appear dark, or when the color tone is poor, please replace the lamp as soon as possible. Do not use old (used) lamps; this is a cause of breakage.

Maintenance

Air filter

Please check and clean the air filter periodically. When the indicators or a message prompts you to clean the air filter, comply with it as soon as possible. The air filter has two kinds of filters inside. Replace the filters when they are damaged or too soiled. To prepare the new filters, make contact with your dealer and tell the following type number.

Type number = 003-002119-01 (MU05661)

When you replace the lamp, please replace the air filter. An air filter of specified type will come together with a replacement lamp for this projector.

- 1 Turn the projector off, and unplug the power cord. Allow the projector to sufficiently cool down.
 - 2 Use a vacuum cleaner on and around the filter cover.
 - 3 Pull the filter cover knobs while lifting it, to take the filter unit off.
 - 4 Use a vacuum cleaner for the filter vent of the projector and both sides of the filter unit.
- If the filters are damaged or too soiled, replace them according to the following procedure number 5 to 7. Otherwise, please jump to the procedure number 8.
- 5 Pull the filter frame's knob up while holding the filter cover to remove the filter frame, then take the filters out.
 - 6 Set new filters where former filters were. Put the larger meshed filter into a filter cover first. Then put the finer meshed filter on the larger meshed one.
 - 7 Put the filter frame back where it was.
 - 8 Put the filter unit back into the projector.
 - 9 Turn the projector on and reset the filter time using the FILTER TIME item in the EASY MENU

- (1) Press the **MENU** button to display a menu.
- (2) Point at the "FILTER TIME" using the ▼/▲ button, then press the ► button. A dialog will appear.
- (3) Press the ▲ button to select RESET on the dialog. It performs resetting the filter time.

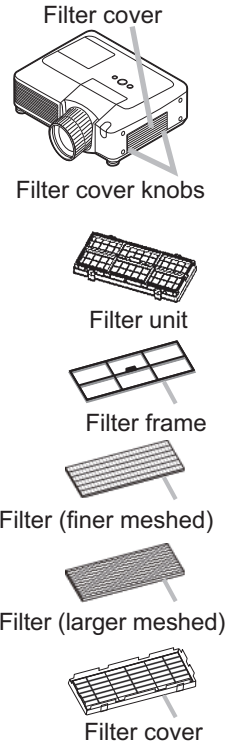

⚠ WARNING ► Before taking care of the air filter, make sure the power cable is not plugged in, then allow the projector to cool sufficiently.

- Use only the air filter of the specified type. Do not use the projector without the air filter or the filter cover. It could result in a fire or malfunction to the projector.
- Clean the air filter periodically. If the air filter becomes clogged by dust or the like, internal temperatures rise and could cause a fire, a burn or malfunction to the projector.

NOTE • Please reset the filter time only when you have cleaned or replaced the air filter, for a suitable indication about the air filter.

- The projector may display the message such as "CHECK THE AIR FLOW" or turn off the projector, to prevent the internal heat level rising.

Internal clock battery

Consumption of the battery makes the clock not to work correctly. When the clock is wrong or it has stopped, please replace the battery according to the following procedures.

1. Turn the projector off, and unplug the power cord. Allow the projector to cool sufficiently.
2. After making sure that the projector has cooled adequately, slowly turn over the projector, so that the bottom is facing.
3. Turn the battery cover fully in the direction indicated “**OPEN**” using a coin or the like, and pick the cover up to remove it.
4. Pry up the battery using a flathead screwdriver or the like to take it out. While prying it up, put a finger lightly on the battery since it may pop out of the holder.
5. Replace battery with new **HITACHI MAXELL**, Part No.**CR2032** or **CR2032H**. Slide the battery in under the plastic claw, and push it into the holder until it clicks.
6. Replace the battery cover in place, then turn it in the direction indicated “**CLOSE**” using such as coins, to fix.

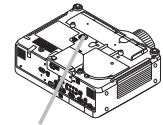

Battery Cover

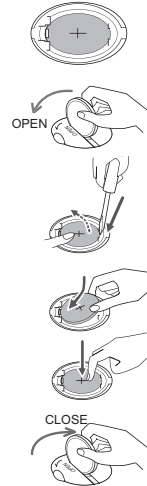

⚠ WARNING ▶ Always handle the batteries with care and use them only as directed. Battery may explode if mistreated. Do not recharge, disassemble or dispose of in fire. And also improper use may result in cracking or leakage, which could result in fire, injury and/or pollution of the surrounding environment.

- Be sure to use only the batteries specified.
- Make sure the plus and minus terminals are correctly aligned when loading a battery. If the battery is placed in the battery holder upside-down, it may be hard to remove.
- Keep a battery away from children and pets. If swallowed consult a physician immediately for emergency treatment.
- Do not short circuit or solder a battery.
- Do not allow a battery in a fire or water. Keep batteries in a dark, cool and dry place.
- If you observe battery leakage, wipe out the leakage and then replace a battery. If the leakage adheres to your body or clothes, rinse well with water immediately.
- Obey the local laws on disposing the battery.

NOTE • The internal clock’s time will be reset when the battery is removed. Please reconfigure the time via the menu or a web browser after replacing the battery.
(📖 Date/Time Settings in the User’s Manual (detailed) - Network Guide)

Other care

Inside of the projector

In order to ensure the safe use of your projector, please have it cleaned and inspected by your dealer about once every year.

Caring for the lens

If the lens is flawed, soiled or fogged, it could cause deterioration of display quality. Please take care of the lens, being cautious of handling.

1. Turn the projector off, and unplug the power cord. Allow the projector to cool sufficiently.
2. After making sure that the projector is cool adequately, lightly wipe the lens with a commercially available lens-cleaning wipe. Do not touch the lens directly with your hand.

Caring for the cabinet and remote control

Incorrect care could have adverse influence such as discoloration, peeling paint, etc.

1. Turn the projector off, and unplug the power cord. Allow the projector to cool sufficiently.
2. After making sure that the projector is cool adequately, lightly wipe with gauze or a soft cloth.
If the projector is extremely dirty, dip soft cloth in water or a neutral cleaner diluted in water, and wipe lightly after wringing well. Then, wipe lightly with a soft, dry cloth.

⚠ WARNING ▶ Before caring, make sure the power switch is off and the power cable is not plugged in, and then allow the projector to cool sufficiently. The care in a high temperature state of the projector could cause a burn and/or malfunction to the projector.

▶ Never try to care for the inside of the projector personally. Doing is so dangerous.

▶ Avoid wetting the projector or inserting liquids in the projector. It could result in a fire, an electric shock, and/or malfunction to the projector.

- Do not put anything containing water, cleaners or chemicals near the projector.
- Do not use aerosols or sprays.

⚠ CAUTION ▶ Please take right care of the projector according to the following. Incorrect care could cause not only an injury but adverse influence such as discoloration, peeling paint, etc.





- ▶ Do not use cleaners or chemicals other than those specified in this manual.
- ▶ Do not polish or wipe with hard objects.

Troubleshooting

Related messages

When the unit's power is on, messages such as those shown below may be displayed. When any such message is displayed on the screen, please follow the instructions described below. If the same message is displayed after the remedy, or if a message other than the following appears, please contact your dealer or service company.

Although these messages will be automatically disappeared around several minutes, it will be reappeared every time the power is turned on.

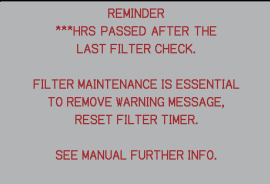
| Message | Description |
|--|---|
|  | <p>There is no input signal. Please confirm the signal input connection, and the status of the signal source.</p> |
|  | <p>The horizontal or vertical frequency of the input signal is not within the specified range. Please confirm the specs for your projector or the signal source specs.</p> |
|  | <p>An improper signal is input. Please confirm the specs for your projector or the signal source specs.</p> |
|  | <p>The internal temperature is rising. Please turn the power off, and allow the projector to cool down at least 20 minutes. After having confirmed the following items, please turn the power ON again.</p> <ul style="list-style-type: none"> • Is there blockage of the air passage aperture? • Is the air filter dirty? • Does the peripheral temperature exceed 35°C? <p>If the same indication is displayed after the remedy, please set FAN SPEED of the SERVICE item in the OPTION Menu to HIGH.</p> |
|  | <p>A note of precaution when cleaning the air filter. Please immediately turn the power off, and clean or change the air filter referring to the “Air filter” section of this manual (📘68). After you have cleaned or changed the air filter, please be sure to reset the filter timer (📘28, 48).</p> |

Regarding the indicator lamps

Lighting and flashing of the **POWER** indicator, the **LAMP** indicator, and the **TEMP** indicator have the meanings as described in the table below. Please follow the instructions within the table. If the same indication is displayed after the remedy, or if an indication other than the following is displayed, please contact your dealer or service company.

| POWER indicator | LAMP indicator | TEMP indicator | Description |
|---|----------------------------------|----------------------|---|
| Lighting In Orange | Turned off | Turned off | The projector is in a standby state. Please refer to the section "Power On/Off". |
| <i>Blinking</i> In Green | Turned off | Turned off | The projector is warming up. Please wait. |
| Lighting In Green | Turned off | Turned off | The projector is in an on state. Ordinary operations may be performed. |
| <i>Blinking</i> In Orange | Turned off | Turned off | The projector is cooling down. Please wait. |
| <i>Blinking</i> In Red | (discretionary) | (discretionary) | The projector is cooling down. A certain error has been detected. Please wait until the POWER indicator finishes blinking, and then perform the proper measure using the item descriptions below. |
| <i>Blinking</i> In Red or Lighting In Red | Lighting In Red | Turned off | The lamp does not light, and there is a possibility that interior portion has become heated. Please turn the power off, and allow the projector to cool down at least 20 minutes. After the projector has sufficiently cooled down, please make confirmation of the following items, and then turn the power on again. <ul style="list-style-type: none"> • Is there blockage of the air passage aperture? • Is the air filter dirty? • Does the peripheral temperature exceed 35°C? If the same indication is displayed after the remedy, please change the lamp referring to the section "Lamp". |
| <i>Blinking</i> In Red or Lighting In Red | <i>Blinking</i> In Red | Turned off | The lamp cover has not been properly fixed. Please turn the power off, and allow the projector to cool down at least 45 minutes. After the projector has sufficiently cooled down, please make confirmation of the attachment state of the lamp cover. After performing any needed maintenance, turn the power on again. If the same indication is displayed after the remedy, please contact your dealer or service company. |

(Continued on next page)

Regarding the indicator lamps (continued)

| POWER indicator | LAMP indicator | TEMP indicator | Description |
|---|--|-------------------------------|--|
| <i>Blinking In Red or Lighting In Red</i> | Turned off | <i>Blinking In Red</i> | <p>The cooling fan is not operating. Please turn the power off, and allow the projector to cool down at least 20 minutes. After the projector has sufficiently cooled down, please make confirmation that no foreign matter has become caught in the fan, etc., and then turn the power on again. If the same indication is displayed after the remedy, please contact your dealer or service company.</p> |
| <i>Blinking In Red or Lighting In Red</i> | Turned off | Lighting In Red | <p>There is a possibility that the interior portion has become heated. Please turn the power off, and allow the projector to cool down at least 20 minutes. After the projector has sufficiently cooled down, please make confirmation of the following items, and then turn the power on again.</p> <ul style="list-style-type: none"> • Is there blockage of the air passage aperture? • Is the air filter dirty? • Does the peripheral temperature exceed 35°C? <p>If the same indication is displayed after the remedy, please set FAN SPEED of the SERVICE item in the OPTION Menu to HIGH.</p> |
| Lighting In Green | Simultaneous <i>blinking in Red</i> | | <p>It is time to clean the air filter. Please immediately turn the power off, and clean or change the air filter referring to the section “Air Filter”. After cleaning or changing the air filter, please be sure to reset the filter timer. After the remedy, reset the power to ON.</p> |
| Lighting In Green | <i>Alternative blinking in Red</i> | | <p>There is a possibility that the interior portion has become overcooled. Please use the unit within the usage temperature parameters (5°C to 35°C). After the treatment, reset the power to ON.</p> |
| <i>Blinking in Green for approx. 3 seconds</i> | Turned off | Turned off | <p>At least 1 “Power ON” schedule is saved to the projector. (Please refer to the User’s Manual (detailed) - Network Guide: Schedule Settings for more information.)</p> |

NOTE • When the interior portion has become overheated, for safety purposes, the power source is automatically turned off, and the indicator lamps may also be turned off. In such a case, press the “O” (OFF) side of the power switch, and wait at least 45 minutes. After the projector has sufficiently cooled down, please make confirmation of the attachment state of the lamp and lamp cover, and then turn the power on again.

Phenomena that may be easy to be mistaken for machine defects

⚠ WARNING ▶ Never use the projector if abnormal operations such as smoke, strange odor, excessive sound, damaged casing or elements or cables, penetration of liquids or foreign matter, etc. should occur. In such cases, immediately turn off the power switch and then disconnect the power plug from the power outlet. After making sure that the smoke or odor has stopped, contact your dealer or service company.

1. Before requesting repair, please check in accordance with the following chart. This operation sometimes resolves your problem. If the situation cannot be corrected,
2. The projector's microprocessor may need to be reset. Please push the Shutdown switch by using a pin or similar and the projector will be turned off immediately. Before turning it again, wait at least 10 minutes to make the projector cool down enough.
3. Some setting may be wrong. Please use the **FACTORY RESET** function of the **SERVICE** item in the **OPTION Menu (U51)** to reset all settings to factory default. Then, if the problem is not removed after the remedy, please contact your dealer or service company.

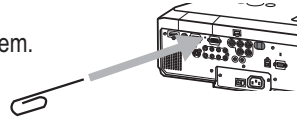

| Phenomenon | Cases not involving a machine defect | Reference page |
|--|--|----------------|
| Power does not come on. | The electrical power cord is not plugged in. Correctly connect the power cord. | 12 |
| | The power switch is not set to the on position. Set the power switch to [] (On). | 17 |
| | The main power source has been interrupted during operation such as by a power outage (blackout), etc. Please turn the power off, and allow the projector to cool down at least 2 minutes, then turn the power on again. | 17 |
| | Either there is no lamp and/or lamp cover, or either of these has not been properly fixed. Please turn the power off, and allow the projector to cool down at least 45 minutes. After the projector has sufficiently cooled down, please make confirmation of the attachment state of the lamp and lamp cover, and then turn the power on again. | 66 |
| Neither sounds nor pictures are outputted. | The signal cables are not correctly connected. Correctly connect the connection cables. | 10 |
| | Signal source does not correctly work. Correctly set up the signal source device by referring to the manual of the source device. | – |
| | The input changeover settings are mismatched. Select the input signal, and correct the settings. | 18, 19 |
| | The BLANK function for pictures and the MUTE function for sounds are working. AV mute may be active. Refer to the item “Sound does not come out” and “No pictures are displayed” on the next page to turn off the MUTE and BLANK functions. | 18, 24 |

(Continued on next page)

Phenomena that may be easily mistaken for machine defects (continued)

| Phenomenon | Cases not involving a machine defect | Reference page |
|---|---|----------------|
| Sound does not come out. | The signal cables are not correctly connected. Correctly connect the audio cables. | 10 |
| | The MUTE function is working. Restore the sound pressing the MUTE or VOLUME button on the remote control. | 18 |
| | The volume is adjusted to an extremely low level. Adjust the volume to a higher level using the menu function or the remote control. | 18 |
| | The AUDIO setting is not correct. Correctly set the items in the AUDIO Menu. | 41 |
| | The audio on your HDMI equipment is not set to Linear PCM. The HDMI input on this projector supports Linear PCM audio only. Check the audio setting on your HDMI equipment. | 11 |
| | The audio on the HDMI input is muted. Change the HDMI AUDIO setting in the AUDIO Menu. | 41 |
| | The digital audio in HDMI signal does not work well. Use the analogue audio, connecting either an RCA audio cable or stereo mini cable. | 10 |
| No pictures are displayed. | The lens cover is attached. Remove the lens cover. | 3, 17 |
| | The signal cables are not correctly connected. Correctly connect the connection cables. | 10 |
| | The brightness is adjusted to an extremely low level. Adjust BRIGHTNESS to a higher level using the menu function or the remote control. | 28 |
| | The computer cannot detect the projector as a plug and play monitor. Make sure that the computer can detect a plug and play monitor using another plug and play monitor. | 11 |
| | The BLANK screen is displayed. Press the BLANK button on the remote control. | 24 |
| No pictures or disturbed pictures are displayed on HDMI input. | The HDMI cable is not correctly connected. Correctly connect the HDMI cable. | 10 |
| | Your HDMI equipment is not compatible with the projector. This projector can be connected with another equipment that has HDMI or DVI connector, but with some equipment the projector may not work properly. | 11 |
| | Your HDMI equipment and the projector are not harmonized. Turn off the both equipment, and turn on them again | – |
| | The signal format on the HDMI is not supported. Check the video setting on your HDMI equipment. | 11 |

Troubleshooting

Phenomena that may be easily mistaken for machine defects (continued)

| Phenomenon | Cases not involving a machine defect | Reference page |
|--|---|-----------------------|
| Video screen display freezes. | The FREEZE function is working. Press the FREEZE button to restore the screen to normal. | 23 |
| Colors have a faded- out appearance, or Color tone is poor. | Color settings are not correctly adjusted. Perform picture adjustments by changing the COLOR TEMP, COLOR, TINT and/or COLOR SPACE settings, using the menu functions. | 28, 30, 34 |
| | COLOR SPACE setting is not suitable. Change the COLOR SPACE setting to AUTO, RGB, SMPTE240, REC709 or REC601. | 34 |
| Pictures appear dark. | The brightness and/or contrast are adjusted to an extremely low level. Adjust BRIGHTNESS and/or CONTRAST settings to a higher level using the menu function. | 28 |
| | The WHISPER function is working. Select NORMAL for the WHISPER item in the SETUP Menu. | 28, 40 |
| | The lamp is approaching the end of its product lifetime. Replace the lamp. | 66, 67 |
| Pictures appear blurry. | Either the focus and/or horizontal phase settings are not properly adjusted. Adjust the focus using the focus ring, and/or H PHASE using the menu function. | 20, 33 |
| | The lens is dirty or misty. Clean the lens referring to the section "Caring for the lens". | 70 |
| Some kind of image degradation such as flickering or stripes appear on the screen. | The OVER SCAN ratio is too big. Adjust OVER SCAN in the IMAGE menu smaller. | 32 |
| | Excessive VIDEO NR. Change the setting of VIDEO NR in the INPUT menu. | 34 |
| | The FRAME LOCK function cannot work on the current input signal. Set FRAME LOCK in the INPUT menu to OFF. | 36 |
| Pictures are trembling. | The exhaust ventilation holes at front is blocked by some objects. Remove any objects from front side of the projector. | 4 |
| The picture is distorted or shifted. | The shape of picture is not corrected appropriately. Use the keystone correction or PERFECT FIT function. | 21, 22 |

NOTE • Although bright spots or dark spots may appear on the screen, this is a unique characteristic of liquid crystal displays, and it does not constitute or imply a machine defect.

Warranty and after-service

If a problem occurs with the equipment, first refer to the “Troubleshooting” and run through the suggested checks. If this does not resolve the problem, please contact your dealer or service company. They will tell you what warranty condition is applied.

Specifications

| Item | Specifications |
|----------------------|--|
| Product name | Liquid crystal projector |
| Liquid Crystal Panel | 2,304,000 pixels (1920 horizontal x 1200 vertical) |
| Lamp | 275 W UHB |
| Audio output | 4 W x 2 |
| Power supply | AC 100-120 V / 5.0 A, AC 220-240 V / 2.1 A |
| Power consumption | 460 W |
| Temperature range | 5 ~ 35 °C (Operating) |
| Size | 418 (W) x 139 (H) x 357 (D) mm (Not including protruding parts) * Please refer to the following figure. |
| Weight (mass) | 7.3 kg (approx.) |
| Ports | RGB1 D-sub 15 pin mini x 1 RGB2 G/Y, B/C _B /P _B , R/C _R /P _R , H, V BNC x 5 S-VIDEO mini DIN 4 pin x 1 VIDEO RCA x 1 Y, C _B /P _B , C _R /P _R (component video) RCA x 3 HDMI HDMI x 1 AUDIO IN1 Stereo mini x 1 AUDIO IN2 Stereo mini x 1 AUDIO IN3 R/L RCA x 1 AUDIO IN4 R/L RCA x 1 RGB OUT D-sub 15 pin mini x 1 AUDIO OUT Stereo mini x 1 USB USB (B) x 1 REMOTE CONTROL Stereo mini x 1 CONTROL D-sub 9 pin x 1 LAN RJ45 x 1 |
| Optional parts | Lamp: 003-120457-01 (DT00873) Air filter: 003-002119-01 (MU05661) * For more information, please consult your dealer. |

NOTE • These specifications are subject to change without notice.

Specifications

Specifications (continued)

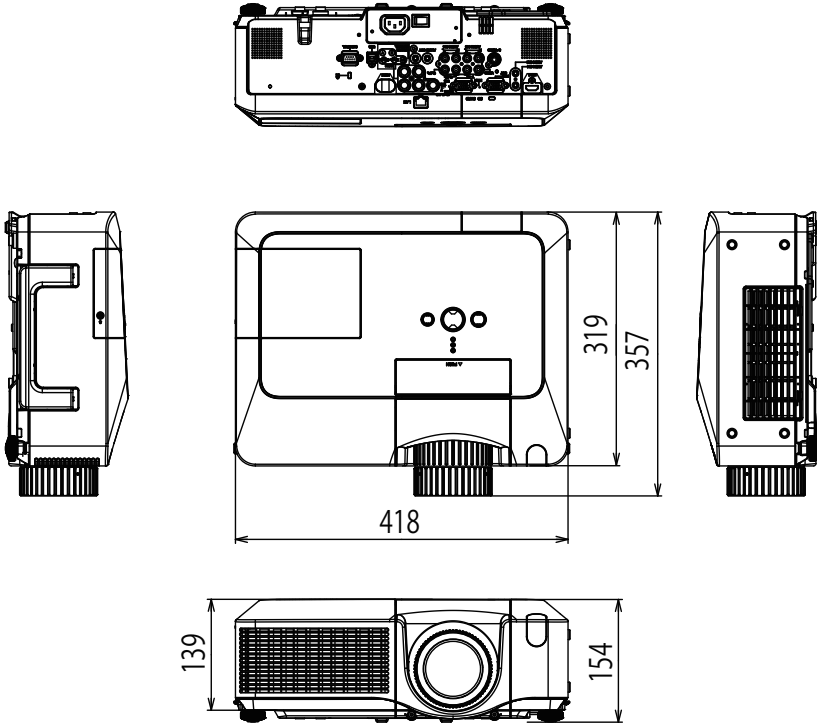

[unit: mm]

Corporate offices

USA – Cypress
ph: 714-236-8610
Canada – Kitchener
ph: 519-744-8005

Worldwide offices

United Kingdom
ph: +44 118 977 8000
Germany
ph: +49 2161 664540
France
ph: +33 (0) 1 41 21 44 04

Hungary/Eastern Europe
ph: +36 (0) 1 47 48 100
Singapore
ph: +65 6877 8737
Shanghai
ph: +86 21 6278 7708

Beijing
ph: +86 10 6561 0240
Korea
ph: +82 2 702 1601
Japan
ph: +81 3 3599 7481

