

BenQ

W20000/W5000 Digital Projector

Home Cinema Series

User Manual

>Welcome

Table of contents

Important safety instructions	3
Overview	6
Shipping contents	6
Remote control batteries	6
Remote control operation	6
Projector features.....	7
Projector exterior view	8
Controls and functions.....	9
Control panel	9
Remote control	10
Positioning your projector.....	11
Choosing a location.....	11
Obtaining a preferred projected image size	12
Shifting the projection lens vertically	12
How to determine the position of the projector for a given screen size	13
How to determine the recommended screen size for a given distance	13
Projection dimensions	14
Connecting with video equipment.....	16
Preparations	16
Connecting HDMI devices.....	17
Connecting RGBHV devices	17
Connecting component-video devices	17
Connecting S-Video or video devices.....	18
Connecting a computer.....	18
Using the projector.....	19
Turning the projector on	19
Selecting an input source	19
Using the menus	20
Fine-tuning the image size and clarity	20
Securing the projector	21
Using a security cable lock.....	21
Utilizing the password function.....	21
Adjusting the projected image	23
Adjusting the projection angle	23
Correcting picture distortion.....	23
Using the preset and user modes.....	24
Fine-tuning the picture quality.....	26
Advanced picture quality controls.....	27
Selecting the aspect ratio	30
Operating in a high altitude environment	31
Displaying more than one image source simultaneously.....	32
Creating your own startup screen	33
Personalizing the projector menu display	33
Locking control keys	33
Turning the power off.....	34
On-Screen Display (OSD) menus	35
Additional information	41
Care of the projector	41
Cleaning and replacing the dust filter	41
Lamp information	43
Getting to know the lamp hour	43
Extending lamp life	43
Timing of replacing the lamp	44
Replacing the lamp.....	44
Indicators	47
Troubleshooting	48
Specifications	49
Warranty and Copyright information.....	52
Regulation statements	53

Thank you for your purchase of this quality BenQ video projector! It has been designed to provide you with an enjoyable home theater viewing experience. For the best results, please read this manual through carefully as it is your guide through the control menus and operation.

Important safety instructions

Your projector is designed and tested to meet the latest standards for safety of information technology equipment. However, to ensure safe use of this product, it is important that you follow the instructions mentioned in this manual and marked on the product.

1. Please read this user manual before you operate your projector. Keep this manual in a safe place for future reference.

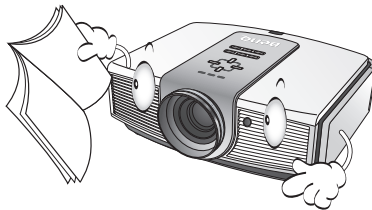

2. Always place the projector on a level, horizontal surface during operation.
 - Do not place the projector on an unstable cart, stand, or table as it may fall and be damaged;
 - Do not place inflammables near the projector;
 - Do not use if tilted at an angle of more than 10 degrees left to right, nor at angle of more than 15 degrees front to back.

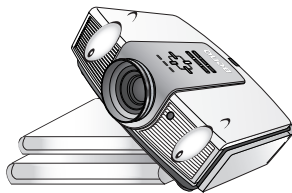

3. Do not store the projector on end vertically. Doing so may cause the projector to fall over, causing injury or resulting in damage.

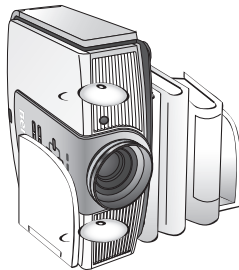

4. Do not place the projector in any of the following environments:
 - space that is poorly ventilated or confined. Allow at least 50 cm clearance from walls and free flow of air around the projector;
 - locations where temperatures may become excessively high, such as the inside of a car with all windows closed;
 - locations where excessive humidity, dust, or cigarette smoke may contaminate optical components, shortening the projector's lifespan and darkening the screen;



- locations near fire alarms;
- locations with an ambient temperature above 35°C/95°F;
- locations where altitude is higher than 1500 meters/4920 feet above sea level.

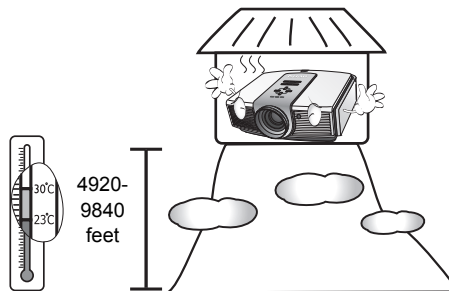

5. Do not block the ventilation holes while the projector is on (even in standby mode):
- Do not cover the projector with any item;
 - Do not place the projector on a blanket, bedding or any other soft surface.

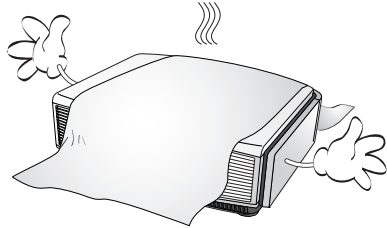

6. In areas where the mains power supply voltage may fluctuate by ± 10 volts, it is recommended that you connect your projector through a power stabilizer, surge protector or uninterruptible power supply (UPS) as appropriate to your situation.

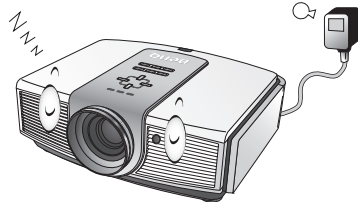

7. Do not step on the projector or place any objects upon it.

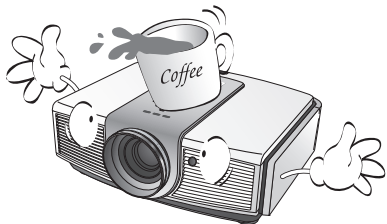

8. Do not place liquids near or on the projector. Liquids spilled into the projector will void your warranty. If the projector does become wet, disconnect it from the power point and call BenQ to have the projector repaired.

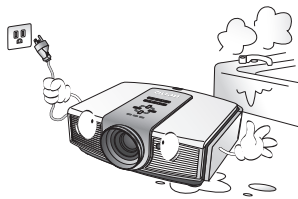

9. Do not look straight into the projector lens during operation. It may harm your sight.

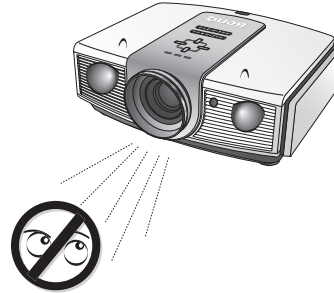

10. Do not operate the projector lamp beyond the rated lamp life. Excessive operation of lamps beyond the rated life could cause a lamp to break on rare occasions.

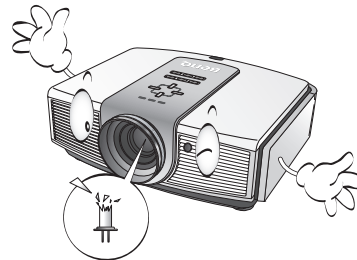

11. The lamp becomes extremely hot during operation. Allow the projector to cool for approximately 45 minutes prior to removing the lamp assembly for replacement.

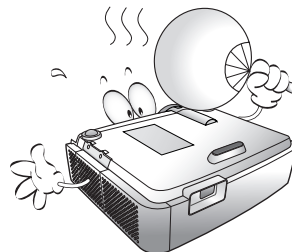

12. This projector is capable of displaying inverted images for ceiling mount installation. Use only BenQ's Ceiling Mounting Kit for mounting.

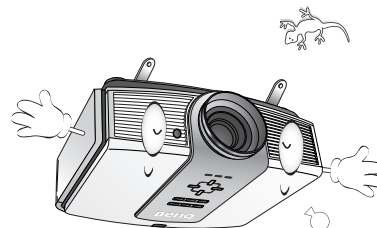

13. Never attempt to replace the lamp assembly until the projector has cooled down and is unplugged from the power supply.

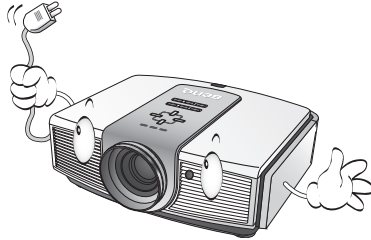

14. When you think service or repair is required, take the projector only to a suitably qualified technician.

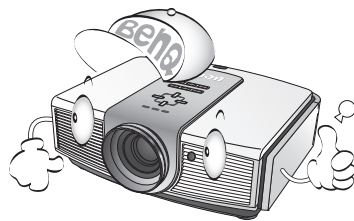

15. Do not attempt to disassemble this projector. There are dangerous high voltages inside which may cause death if you should come into contact with live parts. The only user serviceable parts are the lamp, and air filter which have their own removable covers or access panels. See pages 42 and 44. Under no circumstances should you ever undo or remove any other covers. Refer servicing only to suitably qualified professional service personnel.

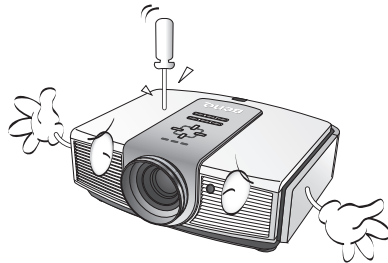

⚠ Notice

Please keep the original packing for possible future shipment. If you need to pack your projector after use, adjust the projection lens to an appropriate position, put the lens cushion around the lens, and fit the lens cushion and projector cushion together to prevent damage during transportation.

Moisture condensation

Never operate the projector immediately after moving it from a cold location to a hot location. When the projector is exposed to such a change in temperature, moisture may condense on the crucial internal parts. To prevent the projector from possible damage, do not use the projector for at least 2 hours when there is a sudden change in temperature.

Avoid volatile liquid

Do not use volatile liquids, such as insecticide or some types of cleaner, near the projector. Do not have rubber or plastic products touching the projector for a long time. They will leave marks on the finish. If cleaning with a chemically treated cloth, be sure to follow the cleaning product's safety instructions.

Disposal

This product contains the following materials which are harmful to human bodies and environment.

- Lead, which is contained in solder.
 - Mercury, which is used in the lamp.
- To dispose of the product or used lamps, consult your local environment authorities for regulations.

Ceiling mounting the projector

We want you to have a pleasant experience using your BenQ projector, so we need to bring this safety matter to your attention to prevent damage to person and property.

If you intend to mount your projector on the ceiling, we strongly recommend that you use a proper fitting BenQ projector ceiling mount kit and that you ensure it is securely and safely installed.

If you use a non-BenQ brand projector ceiling mount kit, there is a safety risk that the projector may fall from the ceiling due to an improper attachment through the use of the wrong gauge or length screws.

You can purchase a BenQ projector ceiling mount kit from the place you purchased your BenQ projector. BenQ recommends that you also purchase a separate Kensington lock compatible security cable and attach it securely to both the Kensington lock slot on the projector and the base of the ceiling mount bracket. This will perform the secondary role of restraining the projector should its attachment to the mounting bracket become loose.

Overview

Shipping contents

The projector is shipped with the cables required for connection to video equipment. Some of the items may not be available depending on your region of purchase. Please check with your place of purchase.

 **Some of the accessories may vary from region to region.**

The warranty card and safety manual are only supplied in some specific regions. Please consult your dealer for detailed information.

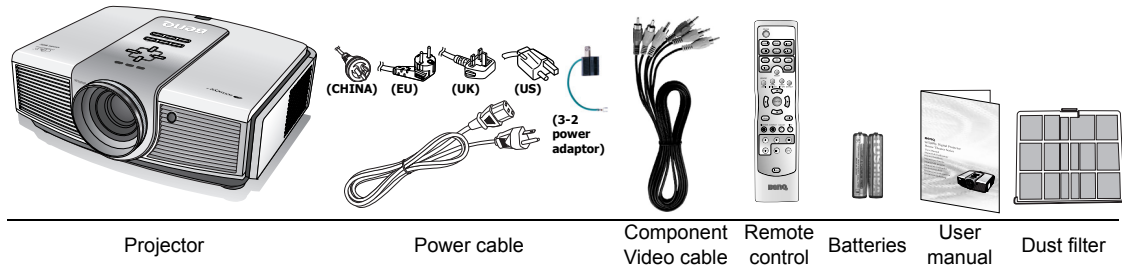

Remote control batteries

- To open the battery cover, turn the remote control over to view its back, push on the finger grip on the cover and slide it down in the direction of the arrow as illustrated. The cover will slide off.
- Remove any existing batteries (if necessary) and install two new AAA batteries observing the battery polarities as indicated in the base of the battery compartment. Positive (+) goes to positive and negative (-) goes to negative.
- Refit the cover by aligning it with the case and sliding it back up into position. Stop when it clicks into place.

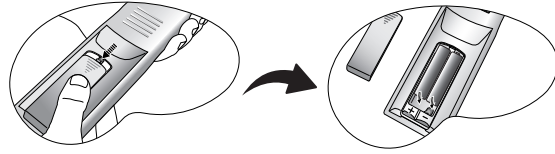

Notes on handling batteries

- Do not mix old batteries with new ones, or mix different types of batteries.
- Avoid leaving the remote control and batteries in an excessive heat or humid environment like the kitchen, bathroom, sauna, sunroom, or in a closed car.
- Dispose of used batteries according to the battery manufacturer's instructions and local environment regulations for your region.
- If the remote control will not be used for an extended period of time, remove the batteries to avoid damage to the control from possible battery leakage.

Remote control operation

- Make sure that there is nothing positioned between the remote control and the infrared (IR) sensor on the projector that might obstruct the IR beam from the remote control reaching the projector.
- The effective range of the remote control is up to 8 meters, and at an angle within 45 degrees of the IR beam. Always aim straight at the projector, however most screens will also reflect the IR beam to the projector.

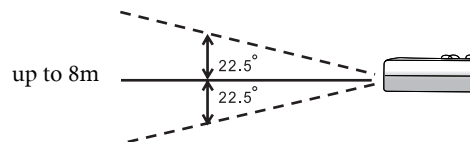

Projector features

- **Full HD compatible**

The projector is compatible with Standard Definition TV (SDTV) 480i, 480p, 576i, 576p, and High Definition TV (HDTV) 720p, 1080i and 1080p formats, with the 1080p format providing a true 1:1 image reproduction.
- **High picture quality**

The projector provides excellent picture quality due to its high resolution, excellent home theater brightness, super high contrast ratio, vivid color and rich gray-scale reproduction.
- **Super-high contrast ratio**

This projector utilizes a motorized IRIS control lens to achieve a super-high contrast ratio.
- **Vivid color reproduction**

This projector features an 7-segment color wheel to produce realistic color depth and range unattainable with lesser segment color wheels.
- **Rich gray-scale**

When viewed in a darkened environment, the automatic gamma control provides excellent gray-scale display which reveals details in shadows and in night or darkened scenes.
- **Extra-low noise operation**

This projector's unique cooling system design prevents unnecessary fan noise, and is rated at less than 25dB in normal mode and a low 23dB when in Whisper mode.
- **Motorized lens shift**

The remote control can be used to adjust vertical lens shift from the comfort of your armchair, which is particularly useful if the projector has been ceiling mounted and accessibility to its panel controls is difficult or awkward.
- **Wide variety of inputs and video formats**

The projector supports a wide variety of inputs for connection to your video and PC equipment, including component video, S-Video, and composite video, as well as HDMI, RGBHD, and an output trigger for connection to automated screen and environment lighting systems.
- **ISF certified calibration control**

To reach a higher standard of performance, the projector incorporates ISF NIGHT and ISF DAY mode settings in its OSD menus, which requires professional calibration service from authorized ISF installers.
- **Panamorph lenses compatible**

The projector is compatible with Panamorph lenses that allow you to convert 16:9 projectors to 2.35:1 aspect ratio.

Projector exterior view

Front and upper side view

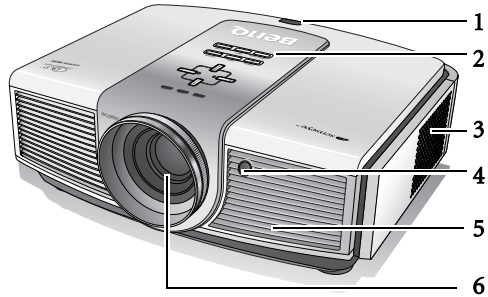

1. Rear IR sensor
2. Control panel (See "Control panel" on page 9 for details.)
3. Dust filter grill (cool air intake)
4. Front IR sensor
5. Vent (heated air exhaust)
6. Projection lens

Rear view

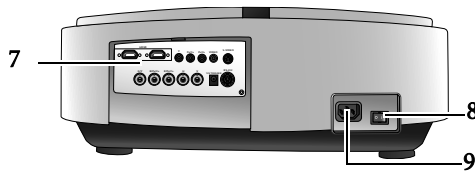

7. Connector panel (see below for details)
8. Main AC power switch
9. Power cable socket

Under and side view

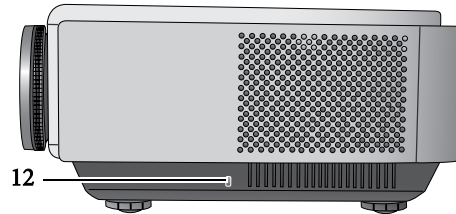
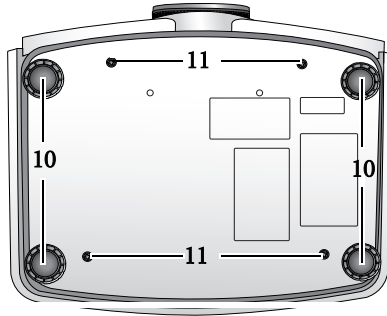

10. Adjustable feet
11. Ceiling mounting holes
12. Kensington lock slot

Connector panel

See "Connecting with video equipment" on page 16 for connection details.

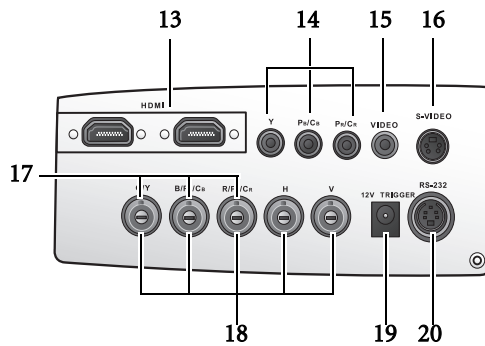

13. HDMI ports
14. Component Video inputs (RCA) support Y/PB/PR or Y/CB/CR video signal
15. Composite Video input (RCA)
16. S-Video input (mini 4-pin DIN)
17. Component video inputs (BNC) support Y/PB/PR, Y/CB/CR, or RGB video signal
18. RGB High Definition inputs (BNC) supports RGBHV video or PC signal
19. 12VDC output terminal Used to trigger external devices such as an electric screen or light control, etc. Consult your dealer for how to connect these devices.
20. RS-232C port for wired remote control

Controls and functions

Control panel

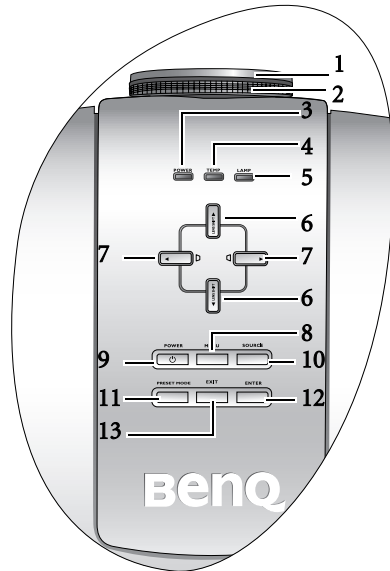

1. **Focus ring**
Adjusts the focus of the projected image.
2. **Zoom ring**
Adjusts the size of the projected image.
3. **POWER indicator light**
Lights up or flashes when the projector is operating. See ["Indicators" on page 47](#) for details.
4. **TEMPerature warning light**
Lights up or flashes if the projector's temperature becomes too high. See ["Indicators" on page 47](#) for details.
5. **LAMP indicator light**
Lights up or flashes when the projector lamp has developed a problem. See ["Indicators" on page 47](#) for details.
6. **LENS SHIFT ▲ (up)**
LENS SHIFT ▼ (down)
Performs the same action as **LENS** and ▲/▼ on the remote control.
Adjusts the motorised vertical lens shift by moving the image upwards or downwards on the screen in relation to the orientation of the projector. See ["Shifting the projection lens vertically" on page 12](#) for details.
When the on-screen menu is activated, moves the selection upwards or downwards.
7. **Keystone ▢ / Left-arrow ◀ button**
Keystone □ / Right-arrow ▶ button
Manually corrects distorted pictures resulting from an angled projection.
See ["Correcting picture distortion" on page 23](#) for details.
When the on-screen menu is activated, moves the selection to the left or right.
8. **MENU button**
Performs the same action as MENU on the remote control.
Toggles the On-Screen Display (OSD) menu on and off. See ["Using the menus" on page 20](#).
9. **POWER button**
Performs the same action as POWER on the remote control.
Toggles the projector between standby and on. See ["Turning the projector on" on page 19](#) and ["Turning the power off" on page 34](#) for details.
10. **SOURCE button**
Performs the same action as the source selection buttons (**COMP1**, **COMP2**, **VIDEO**, **HDMI 1**, **HDMI 2**, **RGB HD**, **S-VIDEO**) on the remote control.
Switches sequentially through input sources. See ["Selecting an input source" on page 19](#) for details.
11. **PRESET MODE button**
Depending upon which input source is selected, selects an available picture setup mode. See ["Selecting a preset mode" on page 24](#) for details.
12. **ENTER button**
Enacts the selected On-Screen Display (OSD) menu item.
13. **EXIT button**
Goes back to previous OSD menus, exits and saves any changes made using the On-Screen Display (OSD) menu. See ["Using the menus" on page 20](#) for details.

Remote control

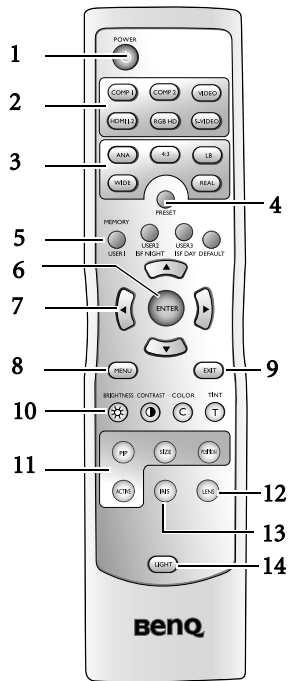

1. **POWER button**
Toggles the projector between standby and on. See "Turning the projector on" on page 19 and "Turning the power off" on page 34 for details.
2. **Source selection buttons (COMP1, COMP2, VIDEO, HDMI 1.2, RGB HD, S-VIDEO)**
Selects an input source for display. See "Selecting an input source" on page 19 for details.
3. **Aspect buttons (ANA, 4:3, LB, WIDE, REAL)**
Selects the display aspect ratio. See "Selecting the aspect ratio" on page 30 for details.
4. **PRESET button**
Selects one of the preset program modes. See "Selecting a preset mode" on page 24 for details.
5. **MEMORY buttons (USER 1, USER 2/ISF NIGHT, USER 3/ISF DAY, and DEFAULT)**
Restores picture settings saved in **USER 1**, **USER 2/ISF NIGHT**, **USER 3/ISF DAY**, or **DEFAULT** for the current input source. See "Setting the User 1/ User 2/User 3 mode" on page 25 for details.
6. **ENTER button**
Enacts the selected On-Screen Display (OSD) menu item.
7. **Arrow buttons (Left ◀, Up ▲, Right ▶, Down ▼)**
Moves the current On-Screen Display (OSD) menu selection in the direction of the arrow being pressed when the OSD menu is activated. See "Using the menus" on page 20 for details.
Adjusts the motorised vertical lens by moving the image upwards or downwards on the screen in relation to the orientation of the projector. (**Up ▲, Down ▼**)
Manually corrects distorted pictures resulting from an angled projection. (**Left ◀, Right ▶**)
8. **MENU button**
Toggles the On-Screen Display (OSD) menu on and off. See "Using the menus" on page 20 for details.
9. **EXIT button**
Goes back to previous OSD menus, exits and saves any changes made using the On-Screen Display (OSD) menu. See "Using the menus" on page 20 for details.
10. **Picture quality adjustment buttons (BRIGHTNESS, CONTRAST, COLOR, TINT):**
Displays the setting bars for adjustment of the appropriate picture quality values. See "Fine-tuning the picture quality" on page 26 for details.
11. **Picture window control buttons (PIP, SIZE, POSITION, ACTIVE)**
Displays the Picture In Picture (PIP) windows, toggles between the main window and sub-window with **ACTIVE**, and adjusts the size and position of the currently active window with **SIZE** and **POSITION**. See "Displaying more than one image source simultaneously" on page 32 for details.
12. **LENS button**
Displays the setting page for the adjustment of the motorised vertical Lens shift value. See "Shifting the projection lens vertically" on page 12 for details.
13. **IRIS button**
Displays the setting bar for the adjustment of the motorised aperture lens IRIS. See "Adjusting contrast ratio via IRIS" on page 29 for details.
14. **LIGHT button**
Turns on the remote control backlight for about 10 seconds. Pressing any other button while the backlight is on keeps the backlight on for a further 10 seconds. Press the button again to turn the backlight off.

Positioning your projector

Choosing a location

Your projector is designed to be installed in one of four possible installation locations:

1. Floor in front of screen;
2. Ceiling in front of screen;
3. Floor at rear of screen; or
4. Ceiling at rear of screen.

Your room layout or personal preference will dictate which installation location you select. Take into consideration the size and position of your screen, the location of a suitable power outlet, as well as the location and distance between the projector and the rest of your equipment.

1. Floor front:

Select this location with the projector placed near the floor in front of the screen. This is the most common way to position the projector for quick setup and portability.

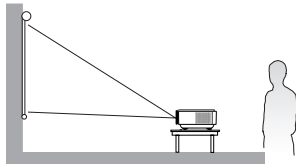

3. Floor rear:

Select this location with the projector placed near the floor behind the screen.

Note that a special rear projection screen is required.

*Set **Floor Rear** after you turn the projector on.

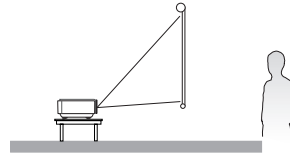

2. Ceiling Front:

Select this location with the projector suspended from the ceiling in front of the screen.

Purchase the BenQ Projector Ceiling Mounting Kit from your dealer to mount your projector on the ceiling.

*Set **Ceiling Front** after you turn the projector on.

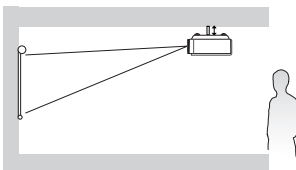

4. Ceiling Rear:

Select this location with the projector suspended from the ceiling behind the screen.

Note that a special rear projection screen and the BenQ Projector Ceiling Mounting Kit are required for this installation location.

*Set **Ceiling Rear** after you turn the projector on.

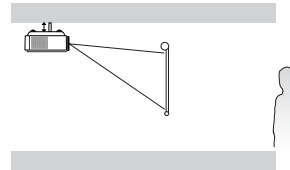

*To set the projector position:

1. Press **MENU** on the projector or remote control and then press **◀/▶** until the **System Setup** menu is highlighted.
2. Press **▲/▼** to highlight **Projector Position** and press **◀/▶** until the correct position is selected.



Obtaining a preferred projected image size

The distance from the projector lens to the screen, the zoom setting, and the video format each factors in the projected image size.

The projector should always be placed horizontally level (like flat on a table), and positioned directly perpendicular (90° right-angle square) to the horizontal center of the screen. This prevents image distortion caused by angled projections (or projecting onto angled surfaces). If the projector is mounted on a ceiling, it must be mounted upside-down.

This projector is equipped with a movable lens. See "[Shifting the projection lens vertically](#)" below for details. You can see the diagrams on pages 14 and 15 for the vertical offset values in the dimension tables that are measured when the lens is shifted fully up or down.

If the projector is positioned further away from the screen, the projected image size increases, and the vertical offset also increases proportionately.

When determining the position of the screen and projector, you will need to account for both the projected image size and the vertical offset dimension, which are directly proportional to the projection distance.

BenQ has provided separate tables of dimensions for both 16:9 and 4:3 screen ratios to assist you in determining the ideal location for your projector. There are two dimensions to consider, the perpendicular horizontal distance from the center of the screen (projection distance), and the vertical offset height of the projector from the horizontal edge of the screen (offset).

Shifting the projection lens vertically

The vertical lens shift control provides flexibility for installing your projector. It allows the projector to be positioned slightly above or below the top level of the projected images.

The lens shift (offset) is expressed as a percentage of the projected image height. It is measured as an offset from the projected image's vertical center. The projector is equipped with +120% and -80% vertical lens shift. You can shift the projection lens upwards or downwards within the allowable range depending on your desired image position.

To adjust the vertical position of the projection lens:

1. Press **LENS** or **▲/▼** (when the OSD menu is not activated) on the remote control, or **LENS SHIFT ▲/▼** on the projector to display the adjustment page.
(Pressing **ENTER** in the **Picture -- Advanced > Lens Shift** menu performs the same function.)
2. To raise the projected image, press **▲** on the remote control or **Lens Shift ▲** on the projector.
To lower the projected image, press **▼** on the remote control or **Lens Shift ▼** on the projector.

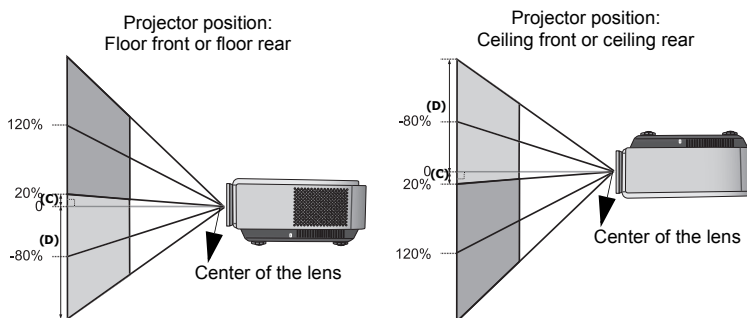
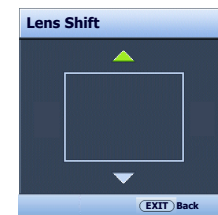

See pages 14 and 15 for the corresponding values of (C) and (D).

How to determine the position of the projector for a given screen size

1. Determine the aspect ratio of your screen, 16:9 or 4:3?
2. Refer to the table and find the closest match to your screen size in the left columns labelled "[Screen Dimensions](#)". Using this value, look across this row to the right to find the corresponding average distance from screen value in the column labelled "[Average](#)". This is the projection distance.
3. Decide the exact height of your projector according to the position of your screen and the adjustable vertical lens shift range.

For example, if you are using an 120-inch, 4:3-aspect-ratio screen, please refer to "[4:3 \(standard\) ratio screen dimension table](#)". The average projection distance is 495 cm.

How to determine the recommended screen size for a given distance

This method can be used for situations where you have purchased this projector and would like to know what screen size will fit in your room.

The maximum screen size is limited by the physical space available in your room.

1. Determine the aspect ratio of your screen, 16:9 or 4:3?
2. Measure the distance between the projector and where you want to position the screen. This is the projection distance.
3. Refer to the table and find the closest match to your measurement in the average distance from screen column labelled "[Average](#)". Check that your measured distance is between the min and max distances listed on either side of the average distance value.
4. Using this value, look across that row to the left to find the corresponding screen diagonal listed in that row. That is the projected image size of the projector at that projection distance.

For example, if you have a 16:9-aspect-ratio screen and your measured projection distance was 4.5m (450cm), please refer to "[16:9 \(widescreen\) ratio screen dimension table](#)". The closest match in the "[Average](#)" column is 449 cm. Looking across this row shows that an 100-inch screen is required.

If you place the projector in a different position (to that recommended), you will have to tilt it down or up to center the image on the screen. In these situations, some image distortion will occur. Use the Keystone function to correct the distortion. See "[Correcting picture distortion](#)" on [page 23](#) for details.

Projection dimensions

Refer to "Dimensions" on page 49 for the center of lens dimensions of this projector before calculating the appropriate position.

Installation for a 16:9 ratio screen

Floor Installation

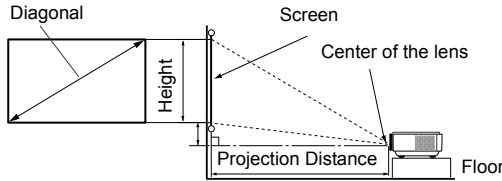

Ceiling Installation

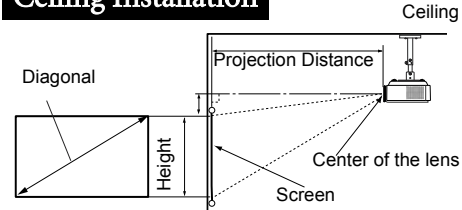

16:9 (widescreen) ratio screen dimension table

Screen Dimensions			Projection Distance in cm			Offset	
Diagonal (inch)	Height (cm)	Width (cm)	Min distance (with max zoom)	Average	Max distance (with min zoom)	Highest lens position (cm) (C)*	Lowest lens position (cm) (D)*
41	51	91	167	184	201	5	-46
50	62	111	204	225	245	6	-56
60	75	133	245	270	294	7	-67
70	87	155	286	315	343	9	-78
80	100	177	327	360	392	10	-90
90	112	199	367	404	441	11	-101
100	125	221	408	449	490	12	-112
110	137	244	449	494	539	14	-123
120	149	266	490	539	588	15	-134
130	162	288	531	584	637	16	-146
140	174	310	571	629	686	17	-157
150	187	332	612	674	735	19	-168
160	199	354	653	719	784	20	-179
170	212	376	694	764	833	21	-191
180	224	398	735	809	882	22	-202
190	237	421	776	854	931	24	-213
200	249	443	816	898	980	25	-224
250	311	553	1020	1122	1224	31	-280
300	374	664	1224	1347	1469	37	-336

* See the pictures of "Shifting the projection lens vertically" on page 12 for the range of (C) and (D)

The above numbers are approximate and may be slightly different from the actual measurements. Only the recommended screen sizes are listed. If your screen size is not in the table above, please contact your BenQ dealer for assistance.

Installation for a 4:3 ratio screen

The illustrations and table below are provided for those users who already have 4:3 aspect ratio screens or intend to purchase 4:3 aspect ratio screens to view 16:9 ratio projected images.

Floor Installation

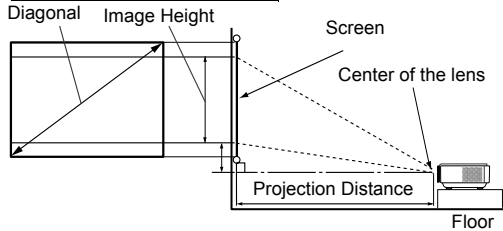

Ceiling Installation

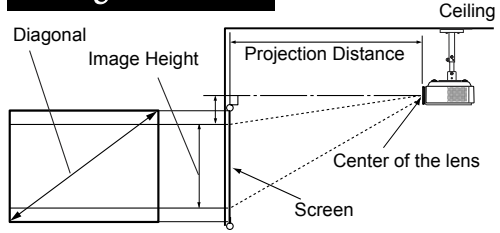

4:3 (standard) ratio screen dimension table

Screen Dimensions			Projection Distance in cm			Offset		Image Height (cm)
Diagonal (inch)	Height (cm)	Width (cm)	Min distance (with max zoom)	Average	Max distance (with min zoom)	Highest lens position (cm) (C)*	Lowest lens position (cm)(D)*	
41	62	83	154	169	184	5	-42	47
50	76	102	187	206	225	6	-51	57
60	91	122	225	248	270	7	-62	69
70	107	142	262	289	315	8	-72	80
80	122	163	300	330	360	9	-82	91
90	137	183	337	371	405	10	-93	103
100	152	203	375	413	450	11	-103	114
110	168	224	412	454	495	13	-113	126
120	183	244	450	495	539	14	-123	137
130	198	264	487	536	584	15	-134	149
140	213	284	525	577	629	16	-144	160
150	229	305	562	618	674	17	-154	171
160	244	325	599	659	719	18	-165	183
170	259	345	637	701	764	19	-175	194
180	274	366	674	742	809	21	-185	206
190	290	386	712	783	854	22	-195	217
200	305	406	749	824	899	23	-206	229
250	381	508	937	1031	1124	29	-257	286
300	457	610	1124	1237	1349	34	-309	343

* See the pictures of "Shifting the projection lens vertically" on page 12 for the range of (C) and (D)

The above numbers are approximate and may be slightly different from the actual measurements. Only the recommended screen sizes are listed. If your screen size is not in the table above, please contact your BenQ dealer for assistance.

Connecting with video equipment

You can connect the projector to any type of video equipment, such as a VCR, DVD player, digital tuner, cable or satellite decoder, video game console or digital camera. You can also connect it to a desktop or laptop PC or Apple Macintosh system. However, it has no built-in speakers and cannot be connected to audio equipment.

The projector can be connected to multiple video equipment at the same time by using different cables. All you need to do is select the appropriate input for the projector to display.

Best video quality

The best available video connection method is HDMI. HDMI (High-Definition Multimedia Interface) supports uncompressed video data transmission between compatible devices like DTV tuners, DVD players and displays over a single cable. It provides pure digital viewing and listening experience.

See "[Connecting HDMI devices](#)" on page 17 for how to connect the projector to a HDMI device.

The RGBHV also provides high video quality that transmits Red, Green, Blue, Horizontal and Vertical sync signals separately on its own conductor.

See "[Connecting RGBHV devices](#)" on page 17 for how to connect the projector to a RGBHV device.

The next best video signal is Component Video (not to be confused with composite Video). Digital TV tuner and DVD players output Component Video natively, so if available on your devices, this should be your connection method of choice in preference to (composite) Video.

See "[Connecting component-video devices](#)" on page 17 for how to connect the projector to a component video device.

Better video quality

The S-Video method provides a better quality analog video than standard composite Video. If you have both composite Video and S-Video output terminals on your Video source device, you should elect to use the S-Video option.

Least video quality

Composite Video is an analog video and will result in a perfectly acceptable, but less than optimal result from your projector, being the least video quality of the available methods described here.

See "[Connecting S-Video or video devices](#)" on page 18 for how to connect the projector to an S-Video or composite Video device.

Preparations

When connecting a signal source to the projector, be sure to:

1. Turn off all equipment before making any connections.
2. Use only the correct type cables for each source with proper type plugs.
3. Ensure that all cable plugs are firmly fitted to the equipment sockets.

 **Note that all cables shown in the following connection diagrams may not be supplied with the projector (See "[Shipping contents](#)" on page 6 for details). Most cables are commercially available from electronics stores.**

Connecting HDMI devices

You should use an HDMI cable when making connection between the projector and HDMI devices.

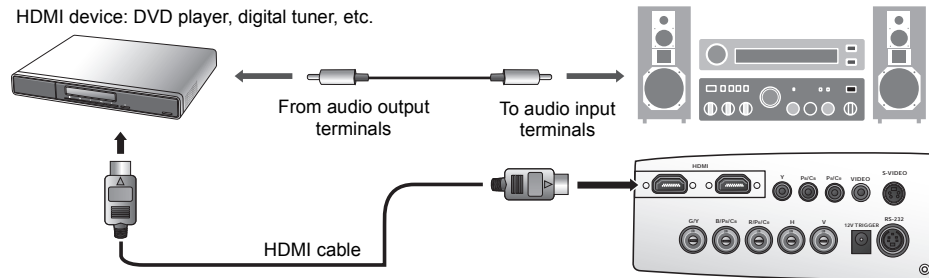

You should also connect the separate audio cable to a suitable audio amplifier.

Connecting RGBHV devices

Use a RGBHV video cable with 5 BNC male connectors for connection. Be sure to match the corresponding colors between the cables and the terminals.

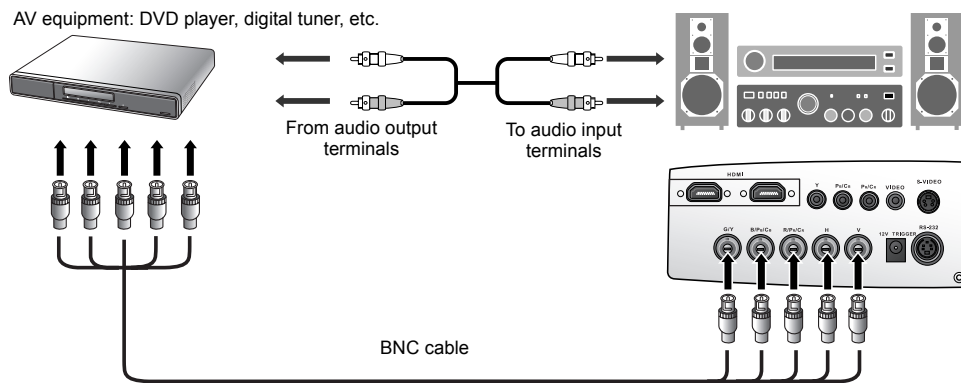

Connecting component-video devices

Be sure to match the corresponding colors between the cables and the terminals.

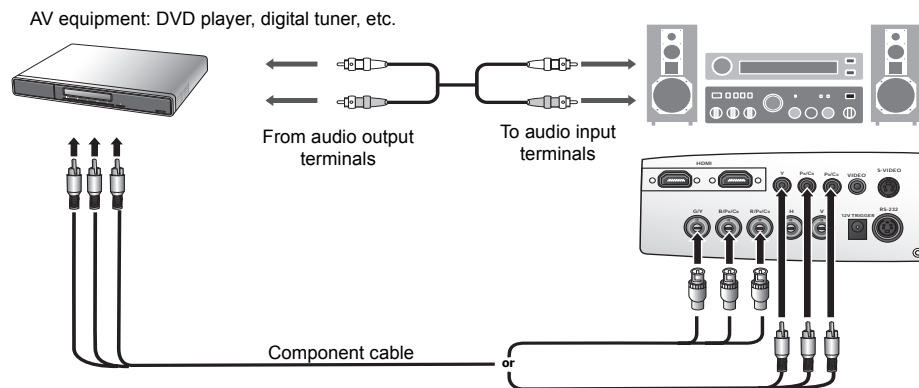

The RCA type component video sockets are provided for connection to video output devices. If you have a BNC type component video cable, you can alternatively connect through the BNC component video sockets.

You should also connect the separate audio cable to a suitable audio amplifier.

Connecting S-Video or video devices

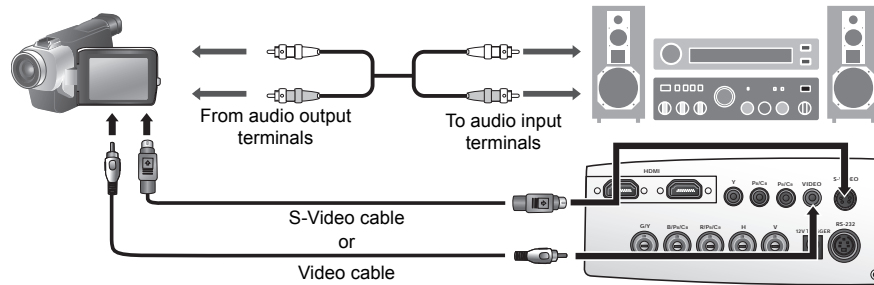

You need only connect S-Video or composite Video cable from the same device, never both at the same time. You should also connect the separate audio cable to a suitable audio amplifier.

If you have already made a Component Video connection between the projector and the video source device, you need not connect to this device again using an S-Video or composite Video connection as this makes an unnecessary second connection of poorer picture quality. You need only connect using a composite Video connection if both Component Video and S-Video are not supplied on the video source device (for example, with some analog video cameras).

Connecting a computer

Connect the projector to a computer with a VGA-BNC cable.

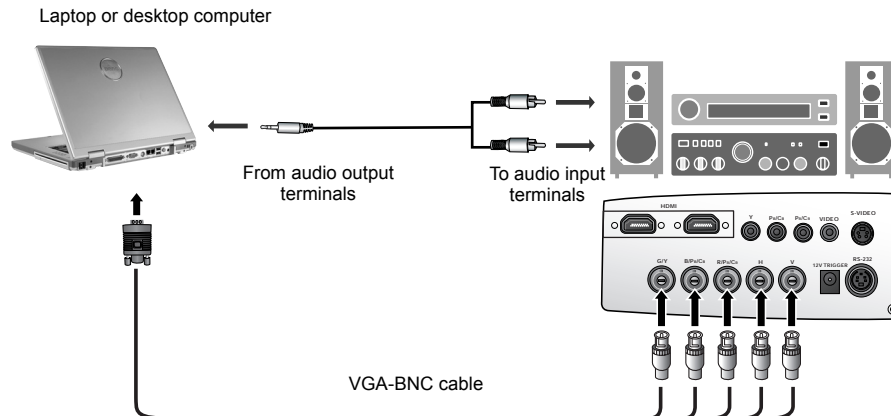

If the selected video image is not displayed after the projector is turned on and the correct video source has been selected, please check that the video source device is turned on and operating correctly. Also check that the signal cables have been connected correctly.

Many laptops do not turn on their external video ports when connected to a projector. Usually a key combination like Fn + F3 or CRT/LCD key turns the external display on/off. Locate a function key labeled CRT/LCD or a function key with a monitor symbol on the laptop. Press Fn and the labeled function key simultaneously. Refer to your laptop's documentation to discover your laptop's key combination.

Using the projector

Preparations

1. Plug in and turn all of the connected equipment on.
2. If not already in, plug the supplied power cable into the AC inlet on the rear of the projector and turn on the power switch.
3. Plug the power cable into a wall socket and turn the wall switch on.

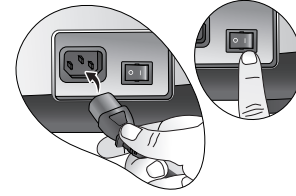

Turning the projector on

Follow the steps below.

1. Make sure the Power light is orange after power has been applied and the main AC power switch is turned on.
2. Press and hold **POWER** () on the projector or remote control to turn the projector on.
3. The fans will start operating, and a start-up image displays on the screen for a few seconds while it warms up.
4. If you are prompted for a password, press the arrow keys to enter a six digit password. See "Utilizing the password function" on page 21 for details.
5. "Source Searching..." will be displayed on the screen before the projector identifies the input signal. This message will remain on the screen until a valid signal is detected. See "Selecting an input source" on page 19 for details.
6. If the horizontal frequency of the input signal exceeds the range of the projector, the message "Out of Range" will be displayed on the screen. This message will remain on-screen until you change the input signal to an appropriate source.

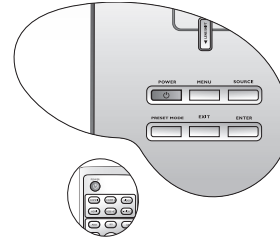

The projector will not respond to further commands while it is warming up.

Selecting an input source

The projector can be connected to multiple equipment at the same time. When the projector is first turned on, it will attempt to reconnect with the input source which was in use when the projector was last shut down.

To select the video source:

- **Using the remote control or projector**

Press one of the Source buttons on the remote control, or press **SOURCE** on the projector repeatedly until your desired signal is selected. To switch between HDMI 1 and HDMI 2, press **HDMI 1.2** again.

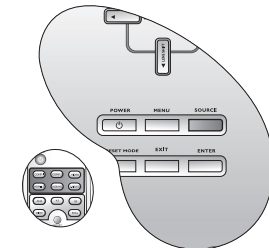

- **Using the OSD menu**

1. Press **MENU** and then press **◀/▶** until the **System Setup** menu is highlighted.
2. Press **▼** to highlight **Input Source** and press **ENTER**. The source selection bar displays.
3. Press **▲/▼** repeatedly until your desired signal is selected and press **ENTER**.

Once detected, the selected source information will display on the screen for seconds. If there is multiple equipment connected to the projector, you can go back to the source selection bar again to search for other signals.

- If you want the projector to automatically search for the signals, select **On** in the **System Setup > Auto Source Search** menu.
- If you want to use the PIP function, see "Displaying more than one image source simultaneously" on page 32 for details.

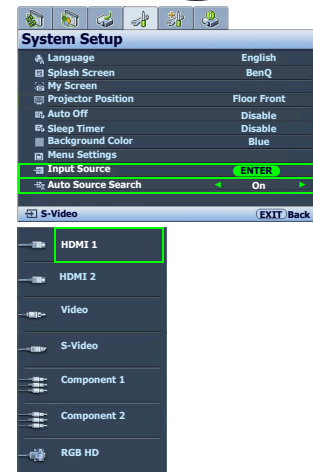

Using the menus

The projector is equipped with multilingual On-Screen Display (OSD) menus for making various adjustments and settings.

Below is the overview of the OSD menu.

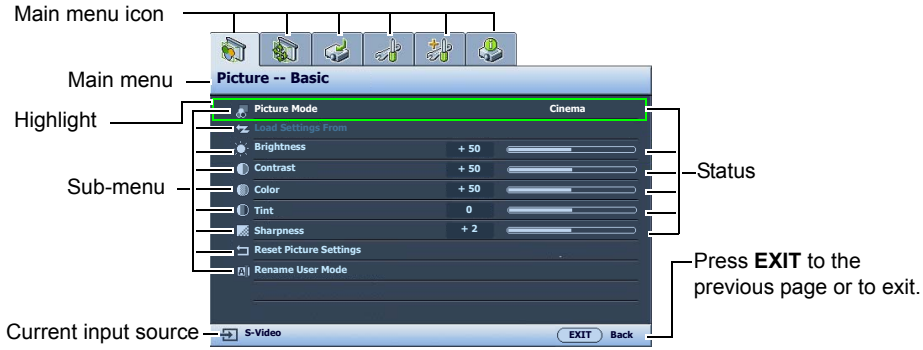

To use the OSD menus, please set the OSD menu to your familiar language first.

1. Press **MENU** on the projector or remote control to turn the OSD menu on.
3. Press **▼** to highlight **Language** and press **◀/▶** to select a preferred language.



2. Use **◀/▶** to highlight the **System Setup** menu.
4. Press **MENU** once or **EXIT** twice* on the projector or remote control to leave and save the settings.



*The first press leads you back to the main menu and the second press closes the OSD menu.

Fine-tuning the image size and clarity

1. Adjust the projected picture to the size that you need using the zoom ring.
2. Then sharpen the picture by rotating the focus ring.

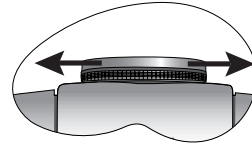
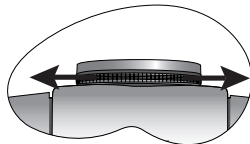

Securing the projector

Using a security cable lock

The projector has to be installed in a safe place to prevent stealing. If not, purchase a lock, like Kensington lock, to secure the projector. You can locate a Kensington lock slot on the rear side of the projector. See item 12 on page 8 for details.

A Kensington security cable lock is usually the combination of key(s) and lock. Refer to the lock's documentation about how to use it.

Utilizing the password function

For security purposes and to help prevent unauthorized use, the projector includes an option for setting up password security. The password can be set through the On-Screen Display (OSD) menu. Once the password is set and this function is selected, the projector is password-protected. Users who do not know the correct password can not use the projector.

- ⚠ **You will be inconvenienced if you activate the password functionality and subsequently forget the password. Print out this manual (if necessary) and write the password you used in this manual, and keep the manual in a safe place for later recall.**

Setting a password

- 👉 **Once a password has been set and activated, the projector cannot be used unless the correct password is entered every time the projector is started.**

1. Press **MENU** on the projector or remote control and then press ◀/▶ until the **Advanced Setup** menu is highlighted.
2. Press ▼ to highlight **Password** and press **ENTER**. The **Password** page displays.
3. Highlight **Password** and press ◀/▶ to select **On**. The **Input Password** page displays.
4. As the picture indicates, the four arrow keys (▲, ▶, ▼, ◀) respectively represent 4 digits (1, 2, 3, 4). According to the password you desire to set, press the arrow keys on the remote control or projector to enter six digits for the password.

Once the password is set, the OSD menu returns to the **Password** page.

IMPORTANT: The digits being input will display as asterisks on-screen. Write your selected password down here in this manual in advance or right after the password is entered so that it is available to you should you ever forget it.

Password: _ _ _ _ _
Keep this manual in a safe place.

5. To leave the OSD menu, press **MENU**.

If you forget the password

If the password function is activated, you will be asked to enter the six-digit password every time you turn on the projector. If you enter the wrong password, the password error message as pictured to the right displays lasting for three seconds, and the **Input Password** page follows. You can retry by entering another six-digit password, or if you did not record the password in this manual, and you absolutely do not remember it, you can use the password recall procedure. See "[Entering the password recall procedure](#)" on page 22 for details.

If you enter an incorrect password 5 times in succession, the projector will automatically shut down in a short time.

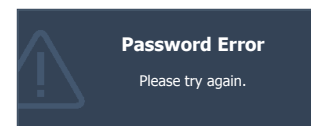
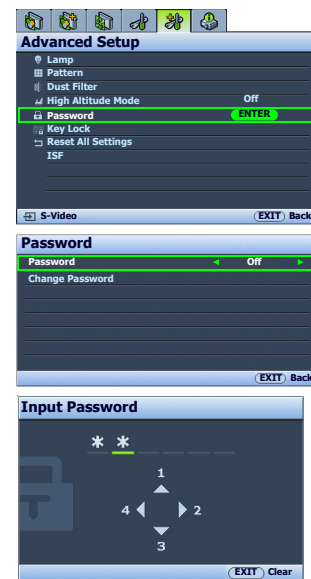

Entering the password recall procedure

1. Press and hold **PRESET MODE** on the projector or **PRESET** on the remote control for 3 seconds. The projector will display a coded number on the screen.
2. Write down the number and turn off your projector.
3. Seek help from the local BenQ service center to decode the number. You may be required to provide proof of purchase documentation to verify that you are an authorized user of the projector.

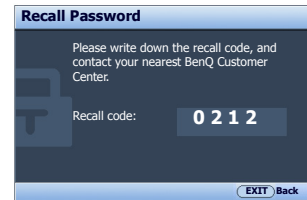

Changing the password

1. Press **MENU** on the projector or remote control and then press ◀/▶ until the **Advanced Setup** menu is highlighted.
2. Press ▲/▼ to highlight **Password** and press **ENTER**. The **Password** page displays.
3. Highlight **Change Password** and press **ENTER**. The **Input Current Password** page displays.
4. Enter the old password.

- If the password is correct, the message **'Input New Password'** displays.
- If the password is incorrect, the password error message displays lasting for three seconds, and the message **'Input Current Password'** displays for your retry. You can either press **MENU** to cancel the change or try another password.

5. Enter a new password.

IMPORTANT: The digits being input will display as asterisks on-screen. Write your selected password down here in this manual in advance or right after the password is entered so that it is available to you should you ever forget it.

Password: _____
Keep this manual in a safe place.

6. Confirm the new password by re-entering the new password.
7. You have successfully assigned a new password to the projector. Remember to enter the new password next time the projector is started.
8. To leave the OSD menu, press **MENU**.

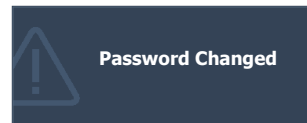

Disabling the password function

To disable password protection, go back to the **Advanced Setup > Password > Password** menu. Highlight **Password** and select **Off** by pressing ◀/▶. The message **'Input Password'** displays. Enter the current password.

- If the password is correct, the OSD menu returns to the **Password** page with **'Off'** shown in the row of Password. You will not have to enter the password next time when turning on the projector.
- If the password is incorrect, the password error message displays lasting for three seconds, and the message **'Input Password'** displays for your retry. You can either press **MENU** to cancel the change or try another password.

Note that though the password function is disabled, you need to keep the old password in hand should you ever need to re-activate the password function by entering the old password.

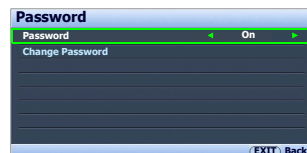

Adjusting the projected image

Adjusting the projection angle

There are four adjuster feet on the bottom of the projector. These can be used if necessary to change the projection angle. Screw the feet in or out as appropriate to aim and level the projection angle.

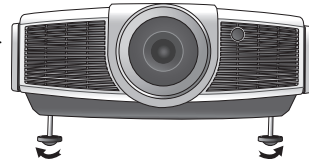

- If the screen and the projector are not perpendicular to each other, the projected image becomes vertical trapezoidal. To correct this problem, see "Correcting picture distortion" on page 23 for details.**

Correcting picture distortion

Keystoning occurs when the projector is not perpendicular to the screen and is where the projected picture displays visible as a trapezoid shape like either of the following:

- Two parallel sides (left and right, or top and bottom) but is noticeably wider on either side.
- No parallel sides.

To correct the picture's shape, you can perform the following steps.

1. Adjust the projection angle. Move the projector to be in front of the center of the screen with the base of the lens level with the top or bottom edge of the screen.
2. If the picture is still distorted, or the projector is unable to be positioned as described above, you will need to manually correct the picture.

Using the remote control or projector

- i. Press one of the Arrow keys on the remote control (◀, ▶) or projector (◻/◀, ◻/▶) to display the **Keystone** page.
- ii. See step **iv** below for further operation.

Using the OSD menu

- i. Press **MENU** and then press ◀/▶ until the **Display** menu is highlighted.
- ii. Press ▼ to highlight **Keystone** and press **ENTER**. The **Keystone** page displays.
- iii. Highlight **2D Keystone** and press **ENTER**. The keystone correction page displays.
- iv. Press the key whose keystone icon is similar to the shape of the projected picture. Continue pressing the same key or press the other keys until you are satisfied with the shape.

The values on the lower portion of the page change while pressing. When the values reach their maximum or minimum with repeated key presses, the picture's shape will stop changing. You will not be able to change the picture further in that direction.

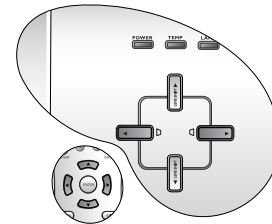

Two parallel sides



No parallel sides



Using the preset and user modes

Selecting a preset mode

The projector is preset with several pre-defined picture modes so that you can choose one to suit your operating environment and input source picture type.

To select a picture mode that suits your need:

- **Using the remote control**
 1. Press **PRESET** repeatedly or **USER 1**, **USER 2/ISF NIGHT**, **USER 3/ISF DAY** on the remote control, or **PRESET MODE** on the projector repeatedly until your desired mode is selected.
- **Using the OSD menu**
 1. Press **MENU** and then press **◀/▶** until the **Picture -- Basic** menu is highlighted.
 2. Press **▼** to highlight **Picture Mode**.
 3. Press **◀/▶** until your desired mode is selected.



These modes consist of preset values suitable for various projection situations as described below:

- **Cinema:** with well-balanced color saturation and contrast with a low brightness level. This is most suitable for enjoying movies in a totally dark environment (as you would find in a commercial cinema).
- **Dynamic:** Maximizes the brightness of the projected image. This mode is suitable for environments where extra-high brightness is required, such as using the projector in well lit rooms.
- **Standard:** Is slightly brighter than **Cinema** mode, and suitable for use in rooms where there is a small amount of ambient light.
- **User 1/User 2/User 3:** Recalls the customized settings. See ["Setting the User 1/User 2/User 3 mode" on page 25](#) for details.

Fine-tuning the selected picture mode

The pre-defined picture mode settings can be altered via the available items shown in the **Picture -- Basic** and **Picture -- Advanced** menus.

To fine-tune the picture mode:

1. Press **MENU** and then press **◀/▶** until the **Picture -- Basic** or **Picture -- Advanced** menu is highlighted.
2. Press **▼** to highlight the item you want to adjust (from among **Brightness**, **Contrast**, **Color**, **Tint**, **Sharpness**, **Black Level**, **Clarity Control**, **Color Temperature**, **Gamma Selection**, **Brilliant Color**, **Color Management**, **IRIS**) and press **◀/▶** to set your desired value. Your selection is automatically stored in the projector and associated with that input source.

See ["Fine-tuning the picture quality" on page 26](#) and ["Advanced picture quality controls" on page 27](#) for details.

Each time you change the picture mode, the projector also changes the setting to the one which was last set for that particular picture mode on that particular input. If you change the input source, the most recently used picture mode and settings for that input and resolution will be restored.

Setting the User 1/User 2/User 3 mode

There are three user-definable modes if the current available picture modes are not suitable for your need. You can use one of the picture modes (except the selected User mode) as a starting point and customize the settings.

1. In the **Picture -- Basic** menu, highlight **Picture Mode** and press ◀/▶ to select **User 1**, **User 2**, or **User 3** mode.
2. Press ▼ to highlight **Load Settings From**.

 **This function is only available when User 1, User 2, or User 3 mode is selected up in the Picture Mode sub-menu item.**

3. Press **ENTER** to display the **Load Settings From** page.
4. Press ▼ to highlight a picture mode that is closest to your need and press **ENTER** and **EXIT**.
5. Press ▼ to select a sub-menu item to be changed and adjust the value with ◀/▶. See "[Fine-tuning the picture quality](#)" on page 26 and "[Advanced picture quality controls](#)" on page 27 for details.
6. When all settings have been done, press **MENU** to save and leave the settings.

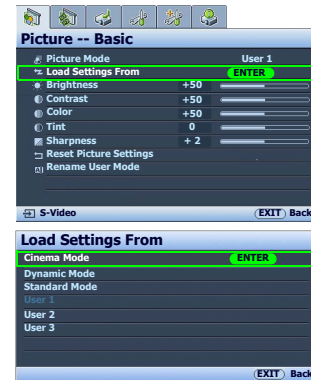

Renaming user modes

You can change **User 1**, **User 2**, and **User 3** to the names easy to be identified or understood by the users of this projector. The new name can be up to 12 characters including English letters (A-Z, a-z), digits (0-9), and space ().

To rename user modes:

1. In the **Picture -- Basic** menu, highlight **Rename User Mode** and press **ENTER** to display the **Rename User Mode** page.
2. Press ▲/▼ to highlight the item you want to rename and press **ENTER**. The first letter will be highlighted by a white box.
3. Press ▲/▼ to select the first character.
4. Press ▶ to move along until the new name is set and press **ENTER** to confirm.
5. Repeat steps 2-4 if you want to change the other names.

Resetting the picture mode

All of the adjustments you've done in the **Picture -- Basic** and **Picture -- Advanced** menus can be returned to the factory preset values with a key press on the highlight of **Reset**.

To reset the picture mode to the preset factory values:

1. In the **Picture -- Basic** menu, highlight **Picture Mode** and press ◀/▶ to select the picture mode (including **User 1**, **User 2**, or **User 3**) you want to reset.
2. Press ▼ to highlight **Reset Picture Settings** and press **ENTER**. The confirmation message displays.
3. Press ◀/▶ to highlight **Reset** and press **ENTER**. The picture mode will return to the factory preset settings.
4. Repeat steps 1-3 if you want to reset other picture modes.

 **Do not be confused with the Reset Picture Settings function here with the Reset All Settings in the Advanced Setup menu. The Reset All Settings function returns most of the settings to the factory preset values system wide. See "[Reset All Settings](#)" on page 39 for details.**

Fine-tuning the picture quality

No matter what picture mode you have selected, you are able to fine-tune those settings to fit every presentation purpose. Those adjustments will be saved to the preset mode you are at when you exit the OSD menu.

Adjusting Brightness

Highlight **Brightness** in the **Picture -- Basic** menu and adjust the values by pressing ◀/▶ on the projector or remote control.

The higher the value, the brighter the picture. And lower the setting, darker the picture. Adjust this control so the black areas of the picture appear just as black and that detail in the dark areas is visible.



Adjusting Contrast

Highlight **Contrast** in the **Picture -- Basic** menu and adjust the values by pressing ◀/▶ on the projector or remote control.

The higher the value, the greater the contrast. Use this to set the peak white level after you have previously adjusted the **Brightness** setting to suit your selected input and viewing environment.



Adjusting Color

Highlight **Color** in the **Picture -- Basic** menu and adjust the values by pressing ◀/▶ on the projector or remote control.

Lower setting produces less saturated colors; setting to the minimum value makes the image black and white. If the setting is too high, colors on the image will be overpowering, which makes the image unrealistic.

Adjusting Tint

Highlight **Tint** and adjust the values by pressing ◀/▶ on the projector or remote control.

The higher the value, the more reddish the picture becomes. The lower the value, the more greenish the picture becomes.

Adjusting Sharpness

Highlight **Sharpness** and adjust the values by pressing ◀/▶ on the projector or remote control.

The higher the value, the sharper the picture becomes. The lower the value, the softer the picture becomes.



The **Brightness**, **Color**, **Contrast**, **Tint** functions can also be accessible by pressing **BRIGHTNESS**, **COLOR**, **CONTRAST**, **TINT** on the remote control to display the adjustment bar and then you can press ◀/▶ to adjust the values.



Advanced picture quality controls

There are more advanced functions in the **Picture -- Advanced** menu to be adjusted to your preference. To save the settings, just press **MENU** to leave the OSD menu.

Setting Black Level

Highlight **Black Level** and press ◀/▶ on the projector or remote control to select **0 IRE** or **7.5 IRE**.

The grayscale video signal is measured in IRE units. In some areas which use NTSC TV standard, the grayscale is measured from 7.5 IRE (black) to 100 IRE (white); however, in other areas which use PAL equipment or Japanese NTSC standard, the grayscale is measured from 0 IRE (black) to 100 IRE (white). We suggest that you check the input source if it is with 0 IRE or 7.5 IRE, then select accordingly.

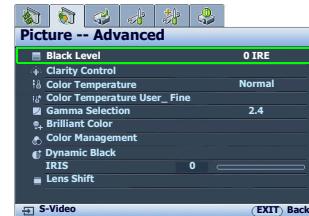

Controlling image clarity

You may have static or noisy projected pictures.

To achieve better picture clarity:

1. Highlight **Clarity Control** and press **ENTER** on the projector or remote control to display the **Clarity Control** page.
2. Press ▲/▼ to select the item you want to adjust and press ◀/▶ to set the desired value.
 - **Noise Reduction:** Reduces electrical image noise caused by different media players. The higher the setting, the less the noise.
 - **Detail Enhancement:** Sharpens the image. The higher the setting, the more details the image reveals.
 - **Luma Transmission** (Luminance Transmission Improvement): Enhances picture brightness. The higher the setting, the more distinct the effect.
 - **Chroma Transmission** (Chroma Transmission Improvement): Reduces color smear. The higher the setting, the more distinct the effect.

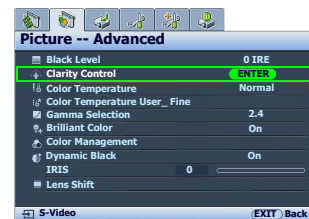

Selecting a color temperature*

Highlight **Color Temperature** and select a preferred setting by pressing ◀/▶ on the projector or remote control.

There are several color temperature settings available.

1. **Lamp Native:** With the lamp's original color temperature and higher brightness. This setting is suitable for environments where high brightness is required, such as projecting pictures in well lit rooms.
2. **Warm:** Makes pictures appear reddish white.
3. **Normal:** Maintains normal colorings for white.
4. **Cool:** Makes pictures appear bluish white.
5. **User 1/User 2/User 3:** Recalls the settings customized in the **Color Temperature User_Fine Tuning** menu. See "[Setting a preferred color temperature](#)" on page 28 for details.



***About color temperatures:**
There are many different shades that are considered to be "white" for various purposes. One of the common methods of representing white color is known as the "color temperature". A white color with a low color temperature appears to be reddish white. A white color with a high color temperature appears to have more blue in it.

Setting a preferred color temperature

To set a preferred color temperature:

1. Highlight **Color Temperature** and select **User 1**, **User 2**, or **User 3** by pressing ◀/▶ on the projector or remote control.
2. Press ▼ to highlight **Color Temperature User_ Fine Tuning** and press ENTER. The **Color Temperature User_ Fine Tuning** page displays.



The menu name 'User_' corresponds with the setting selected in **Color Temperature**.

3. Press ▲/▼ to highlight the item you want to change and adjust the values by pressing ◀/▶.
 - **Red Gain/Green Gain/Blue Gain:** Adjusts the contrast levels of Red, Green, and Blue.
 - **Red Offset/Green Offset/Blue Offset:** Adjusts the brightness levels of Red, Green, and Blue.
4. To save and leave the settings, press **MENU** once or **EXIT** twice.

Color Management

In most installation situations, color management will not be necessary, such as in classroom, meeting room, or lounge room situations where lights remain on, or where building external windows allow daylight into the room.

Only in permanent installations with controlled lighting levels such as boardrooms, lecture theaters, or home theaters, should color management be considered. Color management provides fine color control adjustment to allow for more accurate color reproduction, should you require it.

Proper color management can only be achieved under controlled and reproducible viewing conditions. You will need to use a colorimeter (color light meter), and provide a set of suitable source images to measure color reproduction. These tools are not provided with the projector, however, your projector supplier should be able to provide you with suitable guidance, or even an experienced professional installer.

The **Color Management** provides six sets (RGBCMY) of colors to be adjusted to favorite colors. When you select each color, you can independently adjust its color range and saturation according to your preference.

To adjust and store the settings:

1. In the **Picture -- Advanced** menu, highlight **Color Management** and press ENTER. The **Color Management** page displays.
2. Highlight **Primary Color** and press ◀/▶ to select a color from among **Red, Yellow, Green, Cyan, Blue, and Magenta**.
3. Press ▼ to highlight **Range** and press ◀/▶ to select the color range you wish to make adjustment. The bigger the range, the more proportions of its two adjacent colors the color contains.

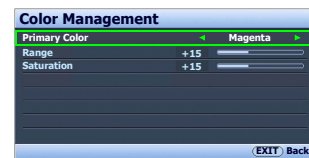
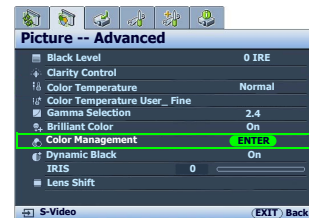

Please refer to the illustration to the right for how the colors relate to each other. For example, if you select **Red** and set its range at 0, only pure red is selected. Increasing its range will include both the red color close to yellow and red color close to magenta.

4. Press ▼ to highlight **Saturation** and adjusts the color saturation level by pressing ◀/▶.

If you select **Red** and set its range at 0, only the saturation of the pure red will be affected.

Saturation is the amount of that color in a video picture. Lower settings produce less saturated colors; a setting of "0" removes that color from the image entirely. If the saturation is too high, that color will be overpowering and unrealistic.

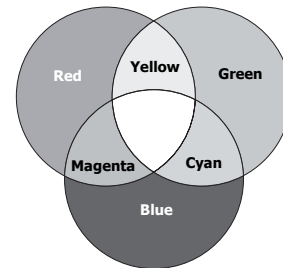

5. To leave and save the settings, press **MENU** once or **EXIT** twice.

Adjusting Brilliant Color

This feature utilizes a new color-processing algorithm and system level enhancements to enable higher brightness while providing truer, more vibrant colors in picture. When set to "Off", Brilliant Color is disabled.

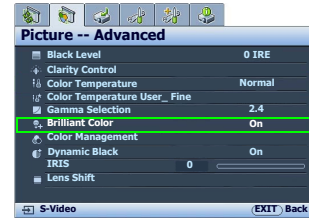

Selecting a Gamma setting

Highlight **Gamma Selection** and select a preferred setting by pressing ◀/▶ on the projector or remote control.

Gamma refers to the relationship between input source and picture brightness.

- **Gamma 2.2**
Increases the average brightness of the picture. Best for a lit environment, meeting room or family room.
- **Gamma 2.4/2.5**
Best for viewing movies in a darken environment.
- **Gamma 2.6/2.8**
Best for viewing movies which are mostly composed of dark scenes.

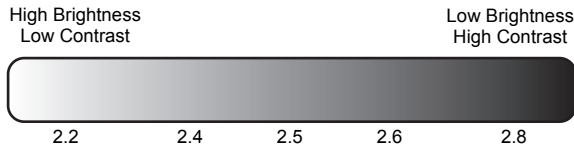

Adjusting contrast ratio via IRIS

The contrast ratio is the measurement of the difference between the brightest whites and the darkest blacks a display can show. This projector has a very high contrast ratio which can reveal subtle color detail not possible with projectors which have a lower contrast ratio. You can adjust the contrast level to allow for ambient lighting levels within the room which may affect color detail. Make sure **Dynamic Black** in the **Picture -- Advanced** menu is set to "On" before you can adjust the contrast ratio.

To manually adjust the contrast ratio,

- **Using the remote control**
 1. Press **IRIS**. The adjustment bar displays.
 2. Press ◀ to lower the contrast and increase brightness, or press ▶ to raise the contrast and decrease brightness.
- **Using the OSD menu**
 1. Press **MENU** and then press ◀/▶ until the **Picture -- Advanced** menu is highlighted.
 2. Press ▼ to highlight **IRIS**.
 3. Press ◀ to lower the contrast and increase brightness, or press ▶ to raise the contrast and decrease brightness.

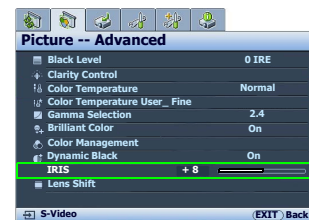
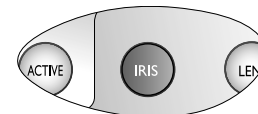
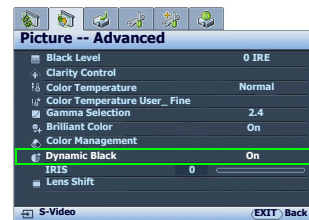

Selecting the aspect ratio

The "aspect ratio" is the ratio of the image width to the image height. Digital TV is usually in 16:9 ratio, which is the default for this projector, and most analog TV signals and DVDs are in 4:3 ratio.

With the advent of digital signal processing, digital display devices like this projector can dynamically stretch and scale the image output to a different aspect than that of the image input source. Images can be stretched in a linear manner so the whole of the image is stretched equally, or non-linearly, which distorts the image.

To change the projected picture ratio (no matter what aspect the source is):

- **Using the remote control**

Press one of the aspect ratio buttons to suit the format of the video signal and your display requirements.

- **Using the OSD menu**

1. Press **MENU** and then press **◀/▶** until the **Display** menu is highlighted.
2. Press **▼** to highlight **Aspect Ratio**.
3. Press **◀/▶** to select an aspect ratio to suit the format of the video signal and your display requirements.



About the aspect ratio

1. **Anamorphic (ANA):** Scales an image so that it is displayed in the center of the screen with a 16:9 aspect ratio. This setting stretches and resizes linearly, except that it treats the vertical and horizontal dimensions independently. It stretches the height of the source image until it reaches the full projected height, and stretches the width of the source image until it reaches the full projected width. This may alter the projected aspect, depending upon the original aspect of the source image. Anamorphic is most suitable for images which are already in a 16:9 aspect, like high definition TV, as it displays them without aspect alteration.
2. **4:3:** Scales a picture so that it is displayed in the center of the screen with a 4:3 aspect ratio. This is most suitable for 4:3 pictures like computer monitors, standard definition TV and 4:3 aspect DVD movies, as it displays them without aspect alteration.
3. **Letter Box (LB):** Scales a picture to fit the projector's native resolution in its horizontal width and resize the picture's height to the 3/4 of the projection width. This may produce a picture greater in height than can be displayed, so part of the picture is lost (not displayed) along the top and bottom edges of the projection. This is suitable for the display of movies which are presented in letter box format (with black bars on the top and bottom).
4. **Wide:** Stretches the picture horizontally in a non-linear manner, that is, the edges of the picture are stretched more than the center of the picture to prevent distortion of the central part of the picture. This is suitable for occasions where you want to stretch the width of a 4:3 aspect picture to the width of a 16:9 aspect screen. It does not alter the height. Some widescreen movies have been produced with their width squashed down to the width of a 4:3 aspect, and are best viewed when restretched back to their original width using this setting.

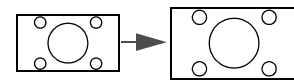

16:9 picture



4:3 picture

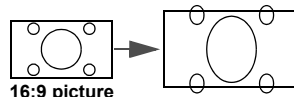

16:9 picture

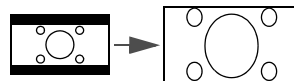

Letter Box
format picture

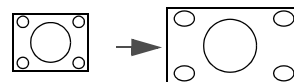

4:3 picture

- Real:** This setting displays the image in a one-to-one pixel mapping without alteration or resize in the centre of the projection. This is most suitable for use with PC and RGBHD source inputs.

 The black portions are inactive areas and the white portions are active areas.



OSD menus can be displayed on those unused black areas.

Using Panamorph lenses (optional)

Panamorph lenses allow you to convert 16:9 projectors to the full 2.35:1 aspect ratio of most of major motion pictures, showing the best movies without letterbox bars at top and bottom of images while increasing resolution by 33% and brightness by 20%.

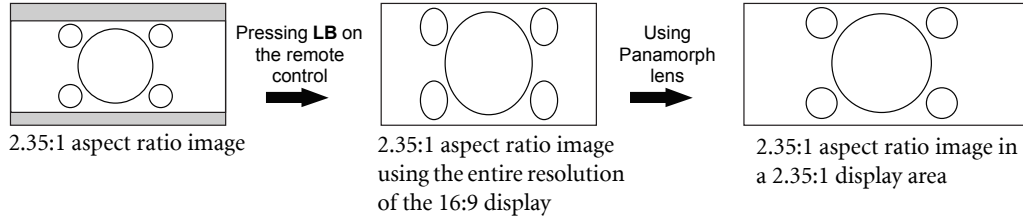

You may need a 2.35:1 screen to display the 2.35:1 images.

For more information, please go to www.panamorph.com or contact the place you purchase the projector.

Operating in a high altitude environment

We recommend you activate **High Altitude Mode** when your environment is higher than 1500 meters (around 4920 feet) above sea level, or whenever the projector will be used for extended periods of time (>10 hours) without shutdown.

To activate **High Altitude Mode**:

- Press **MENU** and then press **◀/▶** until the **Advanced Setup** menu is highlighted.
- Press **▼** to highlight **High Altitude Mode**.
- Press **◀/▶** to select **On**. A confirmation message displays.
- Highlight **Yes** and press **ENTER**.

Operation under **High Altitude Mode** may cause a higher decibel operating noise level because of increased fan speed necessary to improve overall system cooling and performance.

If you use this projector under other extreme conditions excluding the above, it may display auto shut-down symptoms, which is designed to protect your projector from over-heating. In cases like this, you should switch to **High Altitude Mode** to solve these symptoms. However, this is not to state that this projector can operate under any and all harsh or extreme conditions.

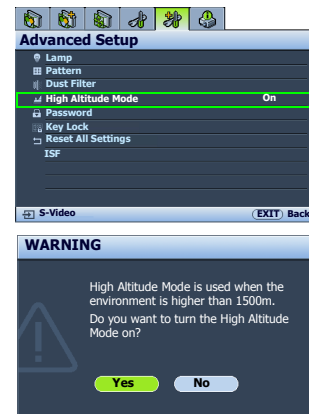

Displaying more than one image source simultaneously

Your projector is capable of displaying pictures simultaneously from two input sources, which can be used to enhance your presentation in an interesting way. Ensure the signals you want to display are correctly connected to the projector.

To display the PIP window:

- **Using the remote control**

Press **PIP** to display the **PIP** page and make adjustments by following the steps starting from step 3 in the section "Using the OSD menu" below.

When the PIP window is on, to change the PIP window size, press **SIZE** repeatedly until a desired size is selected.

When the PIP window is on, to change the PIP window position, press **POSITION** repeatedly until a desired position is selected.

When the PIP window is on, to highlight one of the sources to make adjustments, press **ACTIVE** repeatedly until the source is selected.

- **Using the OSD menu**

1. Press **MENU** and then press **◀/▶** until the **Display** menu is highlighted.
2. Press **▼** to highlight **PIP** and press **ENTER**. The **PIP** page displays.
3. Highlight **PIP** and press **◀/▶** to select **On**.

The projector will select two currently active signals to display and the last viewed picture will be displayed on the big screen as a main source.

☞ See "**PIP source conflict list**" on page 32 for the conflict source combinations.

4. To change the **Main Source** or **Second Source**, press **▼** to highlight **Main Source** or **Second Source** and press **ENTER**. The source selection bar displays.
5. Use **▲/▼** to highlight the source you want to display for the main (bigger) or second (smaller) window, and press **ENTER** to save the setting and go back to the **PIP** page.
6. To make OSD settings to one of the two sources (main or second), highlight **Active Window** and press **◀/▶** to select the source you want to make adjustments.

☞ The settings made on the OSD menus will only take effect on the active window. See "**Disabled functions for the active windows**" on page 32 for exceptions.
7. To change the position of the smaller picture, highlight **Position** and press **◀/▶** repeatedly until a suitable position is selected.
8. To resize the small picture, highlight **Size** and press **◀/▶** to set the PIP size among **Small** or **Large**.
9. To save the settings and leave the OSD menu, press **MENU** once or **EXIT** repeatedly until the menu disappears.

PIP source conflict list

The following source combinations cannot display at the same time for the **PIP** function: **Component+Video**, **Component+S-Video** and **Video+S-Video**.

Disabled functions for the active windows

The following OSD menu functions cannot work on the active windows for the **PIP**: **My Screen**, **Auto Source Search**.

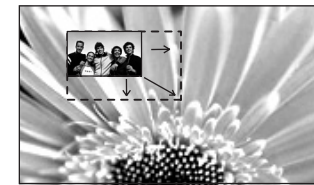
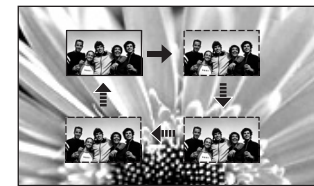
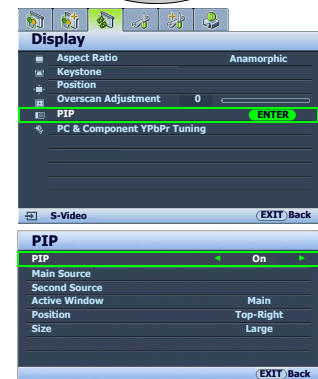
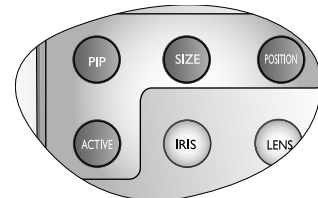

Creating your own startup screen

In addition to selecting the projector preset startup screen from among BenQ logo or Blue screen, you can make your own startup screen that is a picture projected from your computer or video source.

To create your own startup screen, project the picture you want to use as your startup screen from either a computer or video source. The rest steps are as follows.

- **Using the OSD menu**

1. Press **MENU** and then press **◀/▶** until the **System Setup** menu is highlighted.
2. Press **▼** to highlight **My Screen** and press **ENTER**. A confirmation message displays.
3. Press **ENTER** again.
4. The message '**Screen Capturing...**' displays while the projector is processing the picture. Please wait.
5. If the action is successful, you see the message '**Captured Succeeded**' on the screen. The captured picture is saved as **My Screen**.
6. To view the captured picture displayed as the startup screen, set **My Screen** in the **System Setup > Splash Screen** menu and restart the projector.



In the unlikely event that the capturing action fails, change your target picture.

Personalizing the projector menu display

The On-Screen Display (OSD) menu can be set according to your preferences. The following settings do not affect the projection settings, operation, or performance.

- **Rename User Mode:** See "[Renaming user modes](#)" on page 25 for details.
- **Menu Display Time** in the **System Setup > Menu Settings** menu sets the length of time the OSD will remain active after your last key press. The time length ranges from 5 to 30 seconds in 5-second increments. Use **◀/▶** to select a suitable time.
- **Menu Position** in the **System Setup > Menu Settings** menu sets the OSD position in five locations. Use **◀/▶** to select a preferred position.
- **Language** in the **System Setup** menu sets your familiar language for the On-Screen (OSD) Menus. See "[Using the menus](#)" on page 20 for details.
- **Splash Screen** in the **System Setup** menu sets a preferred logo screen to be displayed during projector start-up. See "[Creating your own startup screen](#)" on page 33 for details.

Locking control keys

With the control keys on the remote control and projector locked, you can prevent your projector settings from being changed accidentally (by children, for example). When **Key Lock** is on, no control keys on the remote control and projector will operate except **POWER** and **EXIT**.

To lock the keys:

- **Using the OSD menu**

1. Press **MENU** and then press **◀/▶** until the **Advanced Setup** menu is highlighted.
 2. Press **▼** to highlight **Key Lock**, and press **ENTER**. The control keys lock.
- To unlock the keys, press and hold **EXIT** on the projector or remote control for 5 seconds.

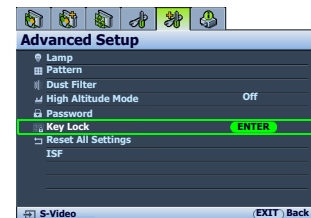

Turning the power off

To turn the projector off, press **POWER** () on the projector or remote control and a warning message appears. Press **POWER** again.

- The Power indicator light flashes orange and the fans run for about two minutes to cool the lamp. The projector will not respond to any commands until the cooling process is complete.
- Then, the Power indicator light is a steady orange once the cooling process has finished and fans stop.
- If the projector will not be used for an extended period, turn the main power switch off and unplug the power cable from the power outlet.
- To protect the lamp, the projector will not respond to any commands during the cooling process.



On-Screen Display (OSD) menus

On-Screen Display (OSD) structure

Please note that the on-screen display (OSD) menus vary according to the signal type selected.

Main menu	Sub-menu	Options	
Picture -- Basic	Picture Mode	Cinema/Dynamic/Standard/User 1/User 2/User 3	
	Load Settings From		
	Brightness	0–100	
	Contrast	0–100	
	Color	0–100	
	Tint	-20–+20	
	Sharpness	0–8	
	Reset Picture Settings		
	Rename User Mode		
	Black Level	0 IRE/7.5 IRE	
	Clarity Control	Noise Reduction	0/1/2/3
Detail Enhancement		0-10	
Luma Transmission		0/1/2	
Chroma Transmission		0/1/2	
Picture -- Advanced	Color Temperature	Lamp Native/Warm/Normal/Cool/User 1/User 2/User 3	
	Color Temperature User_Fine Tuning	Red Gain	0–100
		Green Gain	0–100
		Blue Gain	0–100
	Color Temperature User_Fine Tuning	Red Offset	0–100
		Green Offset	0–100
		Blue Offset	0–100
	Gamma Selection	2.2/2.4/2.5/2.6/2.8	
	Brilliant Color	On/Off	
	Color Management	Primary Color	Red/Yellow/Green/Cyan/Blue/Magenta
Range		0–100	
Saturation		0–100	
Dynamic Black	On/Off		
IRIS	0–19		
Lens Shift			
Display	Aspect Ratio	Anamorphic/4:3/Wide/Real/Letter Box	
	Keystone	2D Keystone	
	Position		
	Overscan Adjustment	0/1/2/3	
	PIP	PIP	On/Off
		Main Source	Video/S-Video/Component 1/Component 2/
		Second Source	HDMI 1/HDMI 2/RGB HD
		Active Window	Main/Second
		Position	Top-Right/Top-Left/Bottom-Right/Bottom-Left
		Size	Large/Small
	PC & Component YPbPr Tuning	H.Size	-15–+15
		Phase	-15–+15
		Auto	

System Setup	Language	English / Français / Deutsch / Italiano / Español / Русский / 繁體中文 / 简体中文 / 日本語 / 한국어 / Svenska / Nederlands / Türkçe / Čeština / Português / ភាសាខ្មែរ / Polski	
	Splash Screen	BenQ/Blue/My Screen	
	My Screen		
	Projector Position	Floor Front/Ceiling Front/Floor Rear/Ceiling Rear	
	Auto Off	Disable/5 min/10 min/15 min/20 min/25 min/30 min	
	Sleep Timer	Disable/30 min/60 min/90 min/120 min/150 min/180 min	
	Background Color	Purple/Black/Blue	
	Menu Settings	Menu Display Time	5 sec/10 sec/15 sec/20 sec/25 sec/30 sec
		Menu Position	Center/Top-Left/Top-Right/Bottom-Right/Bottom-Left
	Input Source	HDMI 1/HDMI 2/Video/S-Video/Component 1/Component 2/RGB HD	
	Auto Source Search	On/Off	
	Advanced Setup	Lamp	Lamp Power
Lamp Hours			(shows lamp hours information)
Reset Lamp Timer			
Pattern		Grid	
		Color Bar	
Dust Filter		Dust Filter Hours	(shows lamp hours information)
		Reset Dust Filter Timer	
High Altitude Mode			On/Off
Password		Password	On/Off
		Change Password	(inputs current password)
Key Lock			
Reset All Settings			
ISF		(inputs current password)	
Information	Source		
	Picture Mode		
	Resolution		
	Lamp Hours	Normal	
		Whisper	
Total			
Dust Filter Hours			

Note that the menu items are available when the projector detects at least one valid signal. If there is no equipment connected to the projector or no signal detected, limited menu items are accessible.

The default values listed in this manual, especially on pages 37-39, are for reference only. They may vary from the projectors due to the continuous improvement to the products.

Picture -- Basic menu

FUNCTION (default setting/value)	DESCRIPTION
Picture Mode (Cinema)	Pre-defined picture modes are provided so you can optimize your projector picture set-up to suit your program type. See "Selecting a preset mode" on page 24 for details.
Load Settings From	Selects a picture mode that most suits your need for the picture quality and further fine-tune the picture based on the selections listed below. See "Setting the User 1/User 2/User 3 mode" on page 25 for details.
Brightness (depends on the selected input source)	Adjusts the brightness of the picture. See "Adjusting Brightness" on page 26 for details.
Contrast (depends on the selected input source)	Adjusts the degree of difference between dark and light in the picture. See "Adjusting Contrast" on page 26 for details.
Color (depends on the selected input source)	Adjusts the color saturation level -- the amount of each color in a video picture. See "Adjusting Color" on page 26 for details.
Tint (depends on the selected input source)	Adjusts the red and green color tones of the picture. See "Adjusting Tint" on page 26 for details.
Sharpness (depends on the selected input source)	Adjusts the picture to make it look sharper or softer. See "Adjusting Sharpness" on page 26 for details.
Reset Picture Settings	Returns all settings in the Picture -- Basic and Picture -- Advanced menus to the factory preset values. See "Resetting the picture mode" on page 25 for details.
Rename User Mode	Renames User 1 , User 2 , or User 3 . See "Renaming user modes" on page 25 for details.

Picture -- Advanced menu

FUNCTION (default setting / value)	DESCRIPTION
Black Level (0 IRE)	Sets the picture grayscale as 0 IRE or 7.5 IRE . See "Setting Black Level" on page 27 for details.
Clarity Control	Adjusts the picture clarity. See "Controlling image clarity" on page 27 for details.
Color Temperature (depends on the selected Picture Mode)	There are several color temperature settings available. See "Selecting a color temperature*" on page 27 for details.
Color Temperature User_ Fine Tuning	See "Setting a preferred color temperature" on page 28 for details.
Gamma Selection (depends on the selected Picture Mode)	See "Selecting a Gamma setting" on page 29 for details.
Brilliant Color (On)	See "Adjusting Brilliant Color" on page 29 for details.
Color Management	See "Color Management" on page 28 for details.
Dynamic Black (On)	See "Adjusting contrast ratio via IRIS" on page 29 for details.

IRIS	See " Adjusting contrast ratio via IRIS " on page 29 for details.
Lens Shift	See " Shifting the projection lens vertically " on page 12 for details.

Display menu

FUNCTION (default setting / value)	DESCRIPTION
Aspect Ratio (Anamorphic)	There are several options to set the picture's aspect ratio depending on your input source. See " Selecting the aspect ratio " on page 30 for details.
Keystone (0)	Corrects any keystone of the picture. See " Correcting picture distortion " on page 23 for details.
Position (0)	Displays the position adjustment page. To move the projected picture, use the directional arrow keys. The values shown on the lower position of the page change with every key press you made until they reach their maximum or minimum.
Overscan Adjustment (depends on the selected input source)	Conceals the poor picture quality in the four edges. You can also manually press ◀/▶ to decide how much to be concealed. Setting 0 means the picture is 100% displayed. The greater the value, the more portion of the picture is concealed while the screen remains filled and geometrically accurate.
PIP	Turns the PIP window on or off and makes related adjustments. See " Displaying more than one image source simultaneously " on page 32 for details.
PC & Component YPbPr Tuning	<p>H.Size (0) Adjusts the horizontal width of the picture.</p> <p>Phase (0) Adjusts the clock phase to reduce picture distortion.</p> <p>Auto Adjusts the phase, and frequency automatically</p> 

System Setup menu

FUNCTION (default setting / value)	DESCRIPTION
Language (English)	Sets the language for the On-Screen Display (OSD) menus. See " Using the menus " on page 20 for details.
Splash Screen (BenQ logo)	Allows you to select which logo screen will display during projector start-up. Three options are available: BenQ logo screen, Blue screen, or My Screen .
My Screen	Captures and stores the projected picture as My Screen. See " Creating your own startup screen " on page 33 for details.
Projector Position (Floor Front)	The projector can be installed on a ceiling or behind a screen, or with one or more mirrors. See " Obtaining a preferred projected image size " on page 12 for details.
Auto Off (Disable)	Prevents unnecessary projection when no signal is detected for a long time. See " Setting Auto Off " on page 43 for details.
Sleep Timer (Disable)	Sets the auto-shutdown timer. The timer can be set to a value between 30 minutes and 3 hours.
Background Color (Blue)	Allows you to choose the color of the background screen that will be displayed when there is no input signal detected.

Menu Settings	<p>Menu Display Time (15 sec) Sets the length of time the OSD will remain active after your last key press. The range is from 5 to 30 seconds in 5-second increments.</p> <p>Menu Position (Center) Sets the On-Screen Display (OSD) menu position.</p>
Input Source	Selects an input source to be projected. See "Selecting an input source" on page 19 for details.
Auto Source Search (Off)	Sets whether the projector searches automatically for input sources. If the source scan is On , the projector will scan for input sources until it acquires a signal. If the function is not activated, the projector selects the last used input source.

Advanced Setup menu

FUNCTION (default setting / value)	DESCRIPTION
Lamp	<p>Lamp Power (Normal) Selects the projector lamp between Normal and Whisper modes.</p> <p>Lamp Hours Shows the lamp hours information. See "Getting to know the lamp hour" on page 43 for details.</p> <p>Reset Lamp Timer Once the lamp is renewed, select Reset to return the lamp timer to '0'. See "Resetting the lamp timer" on page 46 for details.</p>
Pattern	<p>Grid Press ENTER to display the grid test pattern. It helps you adjust the image size and focus and check that the projected image is free of distortion.</p> <p>Color Bar Press ENTER to display the color bar test pattern. You can display this test pattern to check that the colors are to your liking.</p>
Dust Filter	<p>Dust Filter Hours Shows the dust filter hours information</p> <p>Reset Dust Filter Timer Resets the duster filter timer to '0'. See "To clean the filter" on page 42 for details.</p>
High Altitude Mode (Off)	A mode for operation in areas like high altitude or high temperature. See "Operating in a high altitude environment" on page 31 for details.
Password	<p>Password (Off) Limits use of the projector to only those who know the correct password. See "Utilizing the password function" on page 21 for details.</p> <p>Change Password You will be asked to enter the current password before changing to a new one. See "Utilizing the password function" on page 21 for details.</p>
Key Lock	Locks the keys on the projector and remote control except POWER and EXIT . See "Locking control keys" on page 33 for details.
Reset All Settings	Returns all settings to the factory preset values.  The following settings will still remain: Names of user modes, Keystone, Position, H.Size, Phase, Language, Projector Position, High Altitude Mode, Lamp, and Password.

ISF

The ISF calibration menu is password protected and only accessible by authorized ISF calibrators. The ISF (Imaging Science Foundation) has developed carefully crafted, industry-recognized standards for optimal video performance and has implemented a training program for technicians and installers to use these standards to obtain optimal picture quality from BenQ video display devices. Accordingly, we recommend that setup and calibration be performed by an ISF certified installation technician.



For more information, please go to www.imagingscience.com or contact the place you purchased the projector.

Information menu

This menu shows you the current operating status of the projector.

 **Some picture adjustments are available only when certain input sources are in use. Unavailable adjustments are not shown on the screen.**

FUNCTION	DESCRIPTION
Source	Shows the current signal source.
Picture Mode	Shows the selected mode in the Picture -- Basic > Picture Mode menu.
Resolution	Shows the native resolution of the input source.
Lamp Hours	Shows the lamp time used under Normal and Whisper modes.
Dust Filter Hours	Shows the total time of the filter has been used.

Additional information

Care of the projector

Your projector needs little maintenance. The only thing you have to do on a regular basis is keep the lens clean and clean or replace the air filter. Never remove any parts of the projector except the lamp or the air filter. Contact your dealer or local BenQ Customer Service Centre if the projector fails to operate as expected.

Cleaning the lens

Clean the lens whenever you notice dirt or dust on the surface. Before you attempt to clean the lens, turn the projector off, unplug the power cable, and leave it several minutes to cool completely.

1. Use a canister of compressed air to remove dust. (Available from building hardware or photographic suppliers.)
2. If there is stubborn dirt or smudge marks, use a proper photographic lens brush or moisten a clean soft lens cloth with lens cleaner to gently wipe the lens surface.

 **Never touch the lens with your finger or rub the lens with abrasive materials. Even paper towels can damage the lens coating. Only ever use a proper photographic lens brush, cloth, and cleaning solution. Do not attempt to clean the lens while the projector is switched on or is still hot from previous use.**

Cleaning the projector case

Before you attempt to clean the case, turn the projector off, unplug the power cable, and leave it several minutes to cool completely.

1. To remove dirt or dust, wipe the case with a soft, dry, lint-free cloth.
2. To remove stubborn dirt or stains, moisten a soft cloth with water and a neutral detergent. Then wipe the case.

 **Never use wax, alcohol, benzene, thinner or other chemical detergents. These can damage the case.**

Storing the projector

If you need to store the projector for an extended time, please:

1. Make sure the temperature and humidity of the storage area are within the recommended range for the projector. Please refer to the Spec. page in this manual or consult your dealer about the range.
2. Retract the adjuster feet.
3. Remove the batteries from the remote control.
4. Pack the projector in its original packing or equivalent.

Transporting the projector

It is recommended that you ship the projector with its original packing or equivalent. When you carry the projector yourself, please use a soft carry case.

Cleaning and replacing the dust filter

The message to the right displays periodically every 500 hours use. You can also use the **Advanced Setup > Dust Filter > Dust Filter Hours** menu or the **Information > Dust Filter Hours** menu to check how long the filter has been used. If the filter is not cleaned, it can become clogged with dust and prevent proper ventilation. This can cause overheating and a malfunction of the projector. Should the projector filter become seriously clogged with dust, it can cause over-heating inside of the projector.

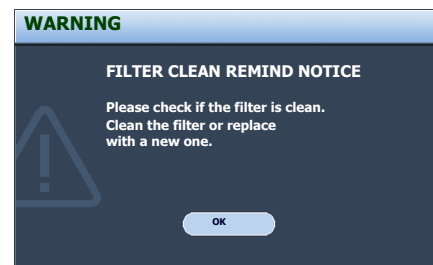

To clean the filter

1. Shut down the projector if turned on and wait until the fans stop running.

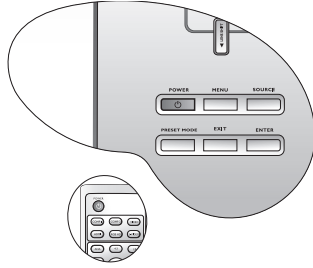

2. Release the bottom edge of the filter cover (right side of projector) by gently pulling the tabs on the lower ends of the panel (as illustrated).

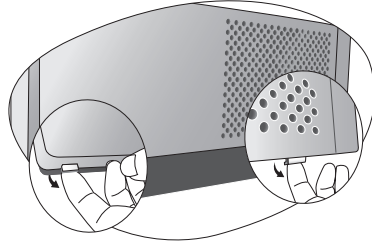

3. Remove the filter cover by gently lifting the loosened cover vertically upwards and then away from the projector body.

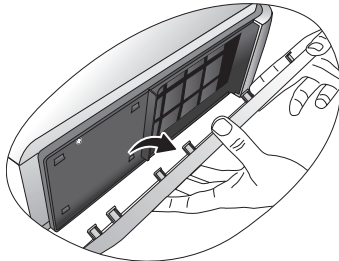

4. Remove the dust filter grill by pulling the tab outwards and away from the projector.

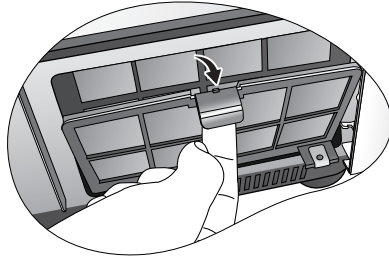

5. Use a small vacuum cleaner (designed for computers and other office equipment) or use a soft brush (such as a clean artist's paintbrush) to vacuum or sweep the dust away.

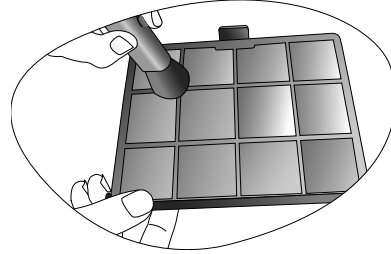

- If the dirt is difficult to remove or the filter is broken, you should replace it.
6. Re-install the filter grill and cover securely.

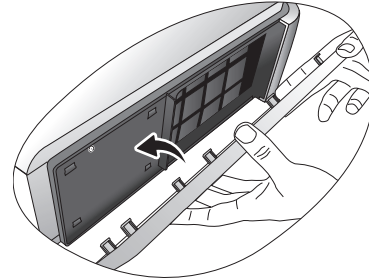

7. Reapply power and turn the projector on.
 - If the filter grill is not correctly seated in place, you will be reminded by messages displayed on the screen until **ENTER** is pressed on the highlight of **OK**.
 - The projector will automatically shut down within minutes if there has been no further action taken. Re-install the filter and cover securely, then turn on the power again.

Resetting the filter timer

- ☞ **Do not reset the filter timer if the filter has not been replaced.**

1. After the startup logo, press **MENU** and then press **◀/▶** until the **Advanced Setup** menu is highlighted.
2. Press **▼** to highlight **Dust Filter** and press **ENTER**. The **Dust Filter** page displays.
3. Highlight **Reset Dust Filter Timer** and press **ENTER**. A warning message displays asking if you want to reset the lamp timer. Highlight **Reset** and press **ENTER**. The filter time will be reset to '0'.

- ☞ **Do not reset if the filter is not new or replaced as this could cause damage.**

Lamp information

Getting to know the lamp hour

When the projector is in operation, the duration (in hours) of lamp usage is automatically calculated by the built-in timer. The method of calculating the equivalent lamp hour is as follows:

Equivalent lamp hour
= 1 (hours used in **Whisper** mode) + 3/2 (hours used in **Normal** mode)

See "**Setting Lamp Power as Whisper**" below for more information on **Whisper** mode.

To obtain the lamp hour information:

1. Press **MENU** and then press **◀/▶** until the **Advanced Setup** menu is highlighted.
2. Press **▼** to highlight **Lamp** and press **ENTER**. The **Lamp** page displays.
3. Highlight **Lamp Hours** and press **ENTER** to display the **Lamp Hours** information page.
4. To leave the menu, press **MENU**.

About Lamp Rest Rate:

Lamp Rest Rate shows the percentage of the lamp rest life. The method of calculating the rate is as follows:

$$\text{Rest Rate} = [1 - (\text{Total Lamp Hours} / 3000)] \times 100\%$$

Extending lamp life

The projection lamp is a consumable item that normally can last up to 2000-3000 hours with proper usage. To keep the lamp life as long as possible, you can do the following settings via the OSD menu.

- **Setting Lamp Power as Whisper**

Using **Whisper** mode reduces system noise and power consumption. If the **Whisper** mode is selected, the light output will be reduced and result in darker projected pictures.

Setting the projector in **Whisper** mode also extends the lamp life. To set

Whisper mode, go into the **Advanced Setup** > **Lamp** > **Lamp Power** menu and press **◀/▶**.

- **Setting Auto Off**

This function allows the projector to turn off automatically if no input source is detected after a set period of time.

To set **Auto Off**, go into the **System Setup** > **Auto Off** menu and press **◀/▶** to select a time period. The time period can be set from 5 to 30 minutes in 5-minute increments. If the preset time lengths are not suitable for your presentation, select **Disable**. The projector will not automatically shut down in a certain time period.





Timing of replacing the lamp

When the **Lamp indicator** lights up red or a message appears suggesting it is time to replace the lamp, please install a new lamp or consult your dealer. An old lamp may cause a malfunction in the projector and in some instances the lamp may explode.

The Lamp indicator light and Temperature warning light will light up if the lamp becomes too hot. Turn the power off and let the projector cool for 45 minutes. If the Lamp or Temp indicator still lights up after turning the power back on, please contact your dealer. See ["Indicators" on page 47](#) for details.

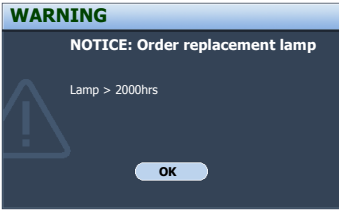
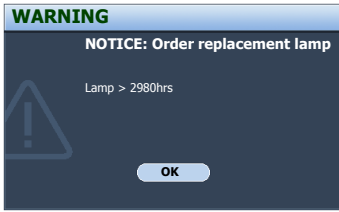
The following Lamp warning displays will remind you to change the lamp.

Status	Message
<p>The lamp has been in operation for 2000 hours. Install a new lamp for optimal performance. If the projector is normally run with Whisper selected (See "Getting to know the lamp hour" on page 43), you may continue to operate the projector until the 2950 hour lamp warning appears.</p> <p>Press ENTER to dismiss the message.</p>	
<p>The lamp has been in operation for 2980 hours. It is strongly recommended that you replace the lamp at this age. The lamp is a consumable item. The lamp brightness diminishes with use. This is normal lamp behavior. You can replace the lamp whenever you notice that the brightness level has significantly diminished. If the lamp is not replaced beforehand, it should be replaced after 2950 hours usage.</p> <p>Press ENTER to dismiss the message.</p>	
<p>The lamp has been in operation for 3000 hours. The lamp MUST be replaced before the projector will operate normally.</p> <p>Press ENTER to dismiss the message.</p>	

Replacing the lamp

⚠ To reduce the risk of electrical shock, always turn the projector off and disconnect the power cord before changing the lamp.

To reduce the risk of severe burns, allow the projector to cool for at least 45 minutes before replacing the lamp.

To reduce the risk of injuries to fingers and damage to internal components, use caution when removing lamp glass that has shattered into sharp pieces.

To reduce the risk of injuries to fingers and/or compromising image quality by touching the lens, do not touch the empty lamp compartment when the lamp is removed.

This lamp contains mercury. Consult your local hazardous waste regulations to dispose of this lamp in a proper manner.

1. Turn the power off and disconnect the projector from the wall socket. Turn off all connected equipment and disconnect all other cables. See ["Turning the power off" on page 34](#) for details.
2. Slightly lift the projector up. Loosen the screws on the lamp cover (located on the left side).

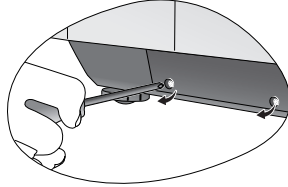

3. Remove the lamp cover.

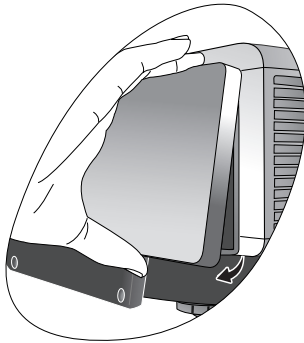

4. Loosen the screws that hold the lamp to the projector. If the screws are not loosened completely, they could injure your fingers. It is strongly recommended that you use a magnetic-head screwdriver to retain the screw should it come loose.

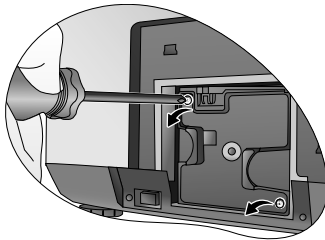

5. Slowly pull the lamp out of the projector.

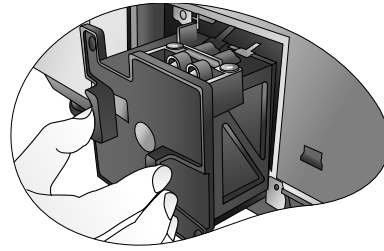

⚠ Pulling it too quickly may cause the lamp to break and scatter broken glass in the projector. To reduce the risk of injuries to fingers and damage to internal components, use caution when removing lamp glass that has shattered.

⚠ Do not place the lamp in locations where water might splash on it, children can reach it, near or above heat sources, or near flammable materials.

⚠ Do not insert your hand into the projector when the lamp is removed. If you touch the optical components inside, it could cause blurred images.

6. Insert the replacement lamp. Make sure it is pushed fully and firmly in place.
7. Tighten the screws securing the lamp box.

⚠ Please be careful to not over-tighten the screws.

⚠ Loose screws may cause a bad connection, which could result in malfunction.

8. Re-install the lamp cover.

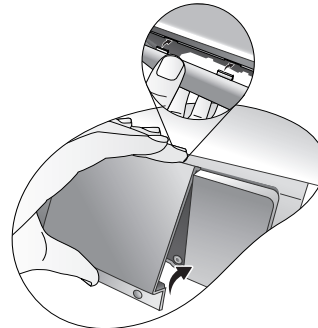

9. Tighten the screws on the lamp cover.
10. Reapply power and turn the projector back on.

Resetting the lamp timer

 **Do not reset the lamp timer if the lamp has not been replaced as this could cause damage.**

1. After the startup logo, press **MENU** and then press **◀/▶** until the **Advanced Setup** menu is highlighted.
2. Press **▼** to highlight **Lamp** and press **ENTER**. The **Lamp** page displays.
3. Highlight **Reset Lamp Timer** and press **ENTER**. A warning message displays asking if you want to reset the lamp timer. Highlight **Reset** and press **ENTER**. The lamp time will be reset to '0'.

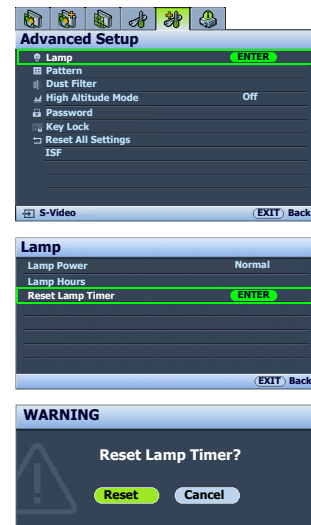

Indicators

There are three indicators which show the status of the projector. Check the following for information about the indicator lights. If there is anything wrong, turn the projector off and contact your dealer.

When the projector is in a normal state, ...

Power	Temp	Lamp	Status & Description
Red	Red	Red	Main power switch on
Orange	Off	Off	Stand-by mode
Green Flashing	Off	Off	Powering up
Green	Off	Off	Normal operation
Orange Flashing	Off	Off	<ul style="list-style-type: none"> The projector needs 90 seconds to cool down as it was abnormally shut down without the normal cooling down process. The projector needs to cool for 90 seconds after the power is turned off.

When the projector is in an abnormal state, ...

Power	Temp	Lamp	Status & Description	
Off	Off	Red	<ul style="list-style-type: none"> The lamp has been damaged. Please contact your local BenQ customer center for purchasing a new lamp. 	
Orange	Off	Red	<ul style="list-style-type: none"> The lamp is not properly attached. The lamp has been damaged. Please contact your local BenQ customer center for purchasing a new lamp. 	
Off	Red	Off	The fans are not working.	
Off	Red	Red		
Off	Red	Green		
Off	Red	Orange		
Off	Green	Red	Fan sensors error	The projector has shutdown automatically. If you try to re-start the projector, it will shutdown again. Please contact your dealer for assistance.
Off	Green	Orange	Fans do not rotate during powering up.	
Red	Red	Red	Thermal condition error	
Red	Red	Green		
Red	Red	Orange		
Green	Red	Red		
Green	Red	Green		
Green	Red	Orange		
Orange	Red	Red	The internal temperature is too high.	
Orange	Red	Green	<ul style="list-style-type: none"> The intake ventilation or the exhaust ventilation is blocked. The projector may be in a poorly ventilated location. The ambient temperature may be too high. 	
Orange	Red	Orange		
Off	Orange	Green	The dust filter is seriously clogged with dust. The projector is going to shut down.	

Troubleshooting

Problem	Cause	Remedy
The projector does not turn on.	There is no power from the power cable.	Plug the power cable into the AC inlet on the rear of the projector, and plug the power cable into to the power outlet. If the power outlet has a switch, make sure that it is switched on. (See page 19)
	The power switch is not in the on position.	Put the power switch in the on position. (See page 19)
	Attempting to turn the projector on again during the cooling process.	Wait until the cooling down process has completed.
	The lamp cover is not securely attached.	Correctly attach the lamp cover. (See page 44)
No picture.	The video source is not turned on or connected correctly.	Turn the video source on and check that the signal cable is connected correctly. (See page 16)
	The projector is not correctly connected to the input source device.	Check the connection. (See page 16)
	The input signal has not been correctly selected.	Select the correct input signal with the Source buttons on the remote control or SOURCE on the projector. (See page 19)
Image is unstable.	The connection cables are not securely connected to the projector or the signal source.	Correctly connect the cables to the appropriate terminals. (See page 16)
Picture is blurred.	The projection lens is not correctly focused.	Adjust the focus of the lens using the focus ring. (See page 20)
	The projector and the screen are not aligned properly.	Adjust the projection angle and direction as well as the height of this unit if necessary. (See page 23)
Remote control does not work correctly	The batteries are out of power.	Replace both of the batteries with new ones. (See page 6)
	There is an obstacle between the remote control and the projector.	Remove the obstacle. (See page 6)
	You are too far away from the projector.	Stand within 8 meters (26.2 feet) of the projector. (See page 6)

Specifications

 All specifications are subject to change without notice.

Optical

Projection system	Single-chip DLP™ system.
DMD chip	0.95" DLP (1920 x 1080)
Lens	F=2.4 to 2.7, f=38.87 to 46.63 mm
Projection screen size	41" to 300"
Lamp	200W

Electrical

Compatibility	PC: 640 x 400 to 1920 x 1080 (16:9) Video: NTSC, PAL, SECAM, YPbPr NTSC(480i)/480p/PAL(576i)/576p, HDTV (720p/1080i) DDC 2B
Color Space	Color Gamut > 55% NTSC

Terminals

Input	Analog RGB: BNC x 5 HDMI (V. 1.2) x 2 Component Video (Y/ CB/ CR, Y/ PB/ PR) x 1 Component Video (Y/ CB/ CR, Y/ PB/ PR) x 1 (shared with BNC) Composite Video x 1 S-Video x 1
Output	12VDC (Max. 0.5 A)
Control	Serial Connector: RS232 8 pin MINI DIN

General characteristics

Projector weight	9.6 kg (21.2 lbs)
Power	VAC 100-240V, 3.2A, 50-60Hz (Automatic)
Power consumption	Max. 340W
Operating temperature	0 °C to 35 °C at sea level
Operating humidity	10% - 90% (without condensation)
Operating altitude	0-1499 m at 0°C-35°C 1500-3000 m at 23°C-30°C (with High Altitude Mode on)
Storage temperature	-20°C- 60°C/-4°F to 140°F
Storage humidity	10% - 90%

Dimensions

492 x 180 x 420 mm (W x H x D)

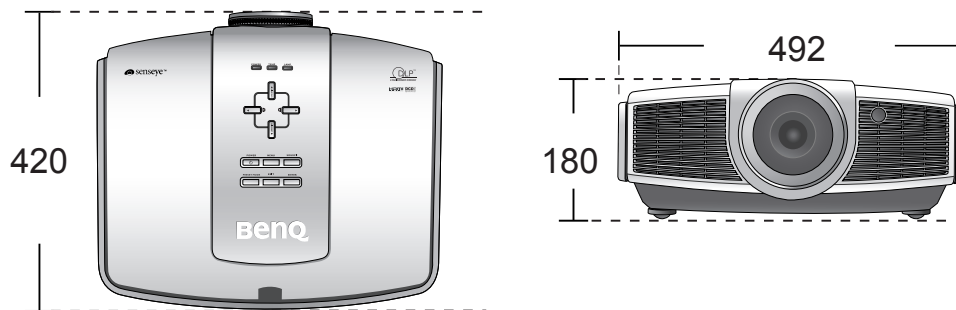

Unit: mm

Timing chart

Supported timing for RGBHV input (Analog or Digital PC signals)

Format	Resolution	Refresh rate(Hz)	H. Freq.(KHz)	Pixel Freq.(MHz)
720 x 400	720 x 400	70	31.469	28.322
		85	37.9	35.5
640 x 480	640 x 480	60	31.469	25.175
		72	37.861	31.5
		75	37.5	31.5
		85	43.269	36
800 x 600	800 x 600	50	31.3	32.051
		56	35.156	36
		60	37.879	40
		72	48.077	50
		75	46.875	49.5
848 x 480	848 x 480	85	53.674	56.25
		60	31.02	33.75
1024 x 768	1024 x 768	60	48.363	65
		70	56.476	75
		75	60.023	78.75
		85	68.677	94.5
1152 x 864	1152 x 864	75	67.5	108
1280 x 768	1280 x 768	60	47.396	68.25
		60	47.776	79.5
		75	60.289	102.25
		85	68.633	117.5
1280 x 960	1280 x 960	60	60	108
		85	85.938	148.5
1280 x 1024	1280 x 1024	60	63.981	108
		75	79.976	135
		85	91.146	157.5
1360 x 768	1360 x 768	60	47.712	85.5
1400 x 1050	1400 x 1050	60	64.744	101
		60	65.317	121.75
		75	82.278	156
1440 x 900	1440 x 900	60	55.469	88.75
		60	59.935	106.5
		75	70.635	136.75
		85	80.43	157
1600 x 1200	1600 x 1200	60	75	162
1680 x 1050	1680 x 1050	60	64.674	119
		60	65.29	146.25
1920 x 1200	1920 x 1200	60	74.038	154

Supported timing for HDMI input

Format	Resolution	Refresh rate(Hz)	H. Freq.(KHz)	Pixel Freq.(MHz)
480/60i	720 x 487	59.94	15.734	13.5
480/60p	720 x 483	59.94	31.469	27
576/50i	720 x 576	50	15.625	14.75
576/50p	720 x 576	50	31.25	29
720/50p	1280 x 720	50	37.5	75.25
720/60p	1280 x 720	60	45	74.25
1080/50i	1920 x 1080	50	28.125/31.25	74.25/72
1080/60i	1920 x 1080	59.94/60	33.716/33.75	74.175/74.25
1080/24P	1920 x 1080	23.98/24	26.978/27	74.175/74.25
1080/25P	1920 x 1080	25	28.125	74.25
1080/30P	1920 x 1080	29.97/30	33.716/33.75	74.175/74.25
1080/50P	1920 x 1080	50	56.25	148.5
1080/60P	1920 x 1080	59.94/60	67.433/67.5	148.35/148.5

Supported timing for EDTV and HDTV (via Component and RGBHV inputs)

Format	Resolution	Refresh rate(Hz)	H. Freq.(KHz)	Pixel Freq.(MHz)
480/60i	720 x 487	59.94	15.734	13.5
480/60p	720 x 483	59.94	31.469	27
576/50i	720 x 576	50	15.625	14.75
576/50p	720 x 576	50	31.25	29
720/50p	1280 x 720	50	37.5	75.25
720/60p	1280 x 720	60	45	74.25
1080/50i	1920 x 1080	50	28.125/31.25	74.25/72
1080/60i	1920 x 1080	59.94/60	33.716/33.75	74.175/74.25
1080/24P	1920 x 1080	23.98/24	26.978/27	74.175/74.25
1080/25P	1920 x 1080	25	28.125	74.25
1080/30P	1920 x 1080	29.97/30	33.716/33.75	74.175/74.25
1080/50P	1920 x 1080	50	56.25	148.5
1080/60P	1920 x 1080	59.94/60	67.433/67.5	148.35/148.5

Supported timing for Video and S-Video inputs

Format	Resolution	Refresh rate(Hz)	H. Freq.(KHz)	Pixel Freq.(MHz)
NTSC 3.58	-	59.94/60	15.734/15.75	3.58
NTSC 4.43	-	59.94/60	15.734/15.75	4.43
PAL-B/G	-	50	15.625	4.43
PAL M	-	59.94/60	15.734/15.75	3.58
PAL N	-	50	15.625	3.58
PAL 60	-	59.94/60	15.734/15.75	4.43
SECAM	-	50	15.625	4.25/4.41

Warranty and Copyright information

Warranty

BenQ warrants this product against any defects in material and workmanship, under normal usage and storage.

Proof of purchase date will be required with any warranty claim. In the event this product is found to be defective within the warranty period, BenQ's only obligation and your exclusive remedy shall be replacement of any defective parts (labor included). To obtain warranty service, immediately notify the dealer from which you purchased the product of any defects.

Important: The above warranty shall be void if the customer fails to operate the product in accordance with BenQ's written instructions, especially the ambient humidity must be in-between 10% and 90%, temperature in-between 0°C and 35°C, altitude lower than 3000 meters, and avoiding to operate the projector in a dusty environment. This warranty gives you specific legal rights, and you may have other rights which vary from country to country.

For other information, please visit www.BenQ.com.

Copyright

Copyright © 2007 by BenQ Corporation. All rights reserved. No part of this publication may be reproduced, transmitted, transcribed, stored in a retrieval system or translated into any language or computer language, in any form or by any means, electronic, mechanical, magnetic, optical, chemical, manual or otherwise, without the prior written permission of BenQ Corporation.

All trademarks and registered trademarks are the property of their respective owners.

Disclaimer

BenQ Corporation makes no representations or warranties, either expressed or implied, with respect to the contents hereof and specifically disclaims any warranties, merchantability or fitness for any particular purpose. Further, BenQ Corporation reserves the right to revise this publication and to make changes from time to time in the contents hereof without obligation of BenQ Corporation to notify any person of such revision or changes.

Regulation statements

FCC statement (for United States users)

This equipment has been tested and found to comply with the limits for a Class B digital device, pursuant to Part 15 of the FCC Rules. These limits are designed to provide reasonable protection against harmful interference in a residential installation.

CLASS B: This equipment generates, uses and can radiate radio frequency energy and, if not installed and used in accordance with the instructions, may cause harmful interference to radio communications. However, there is no guarantee that interference will not occur in a particular installation. If this equipment does cause harmful interference to radio or television reception, which can be determined by turning the equipment off and on, the user is encouraged to try to correct the interference by one or more of the following measures:

- Reorient or relocate the receiving antenna.
- Increase the distance between the equipment and receiver.
- Connect the equipment into an outlet on a circuit different from that to which the receiver is connected.
- Consult the dealer or an experienced radio/TV technician for help.

EEC statement (for European users)

This machine was tested against the 89/336/EEC (European Economic Community) for EMC (Electro Magnetic Compatibility) and fulfills these requirements.

MIC statement

B class equipment (Household purpose info/telecommunications equipment)

As this equipment has undergone EMC registration for household purpose, this product can be used in any area including residential areas.

WEEE directive

Disposal of Waste Electrical and Electronic Equipment by users in private households in the European Union.

This symbol on the product or on the packaging indicates that this can not be disposed of as household waste. You must dispose of your waste equipment by handing it over to the applicable take-back scheme for the recycling of electrical and electronic equipment. For more information about recycling of this equipment, please contact your city office, the shop where you purchased the equipment or your household waste disposal service. The recycling of materials will help to conserve natural resources and ensure that it is recycled in a manner that protects human health and environment.

