

Projector

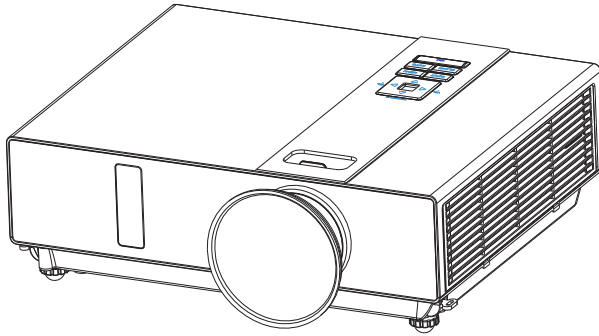

About the Owner's Manual

Please read the owner's manual thoroughly to ensure correct usage of the projector and its features.

After reading, store the owner's manual in a safe place for future reference.

Features

1. Dress up Design
2. Designed for tough environment
3. Side change lamp
4. Side change filter
5. Quick off
6. Advanced Anti-theft features
7. Five auto features (Auto Search, Auto Sync, Auto Ceiling, Auto Keystone and Auto Filter Alert)
8. Seven display modes (Natural, Cinema, Daylight, Green board, White Board, Black Board and User)
9. Built-in 8W speaker
10. Logo capture
11. Image freeze function
12. Digital zoom adjustment
13. Extreme Short Throw Distance.

The content of this manual is subject to change without previous notice.

All rights reserved.

Issue of edition 1002.05_01

Contents

About Owner's Manual

| | |
|---|------------|
| Contents | 1 |
| Contents of Your Box | 3-A |
| Safety Instructions | 4 |
| Safety Labels..... | 5 |
| Part Names | 6 |
| Projector..... | 6 |
| Control Panel..... | 7 |
| Rear..... | 8 |
| Setting Up | 9 |
| Arrangement..... | 9 |
| Power ON / OFF..... | 10 |
| Setting Up The Projector | 11 |
| Ceiling Mounted Installation Guide | 12 |
| Adjusting The Projector's Elevation | 13 |
| How To Connect..... | 14 |
| Remote Control | 16 |
| Remote Control (Optional) | 19 |
| Menu Operation..... | 23 |
| How To Operate On-Screen Display | 23 |
| MENU (PC Mode)..... | 24 |
| Picture Menu (PC Mode)..... | 24 |
| Audio Menu (PC Mode)..... | 25 |
| Setting Menu (PC Mode)..... | 26 |
| MENU (Video Mode)..... | 27 |
| Picture Menu (Video Mode)..... | 27 |
| Audio Menu (Video Mode) | 28 |
| Setting Menu (Video Mode)..... | 29 |

Contents

| | |
|---|-----------|
| MENU | 30 |
| Advanced Menu..... | 30 |
| Presentation Menu | 33 |
| Security Menu..... | 35 |
| PIN Key In Operation..... | 38 |
| Network Control Software Application | 39 |
| Before Use | 40 |
| Before To Use Network Control Software | 40 |
| Projector Auto Search..... | 41 |
| Modify the Projector Setting | 44 |
| Registering And Configuring the Projector..... | 45 |
| Delete..... | 45 |
| Projector Setting | 46 |
| System Setting / Monitor / Default Setting / Auto Detect Optimal Setting..... | 48 |
| Link..... | 49 |
| Control Panel Window Introduction..... | 50 |
| Power Control / Input Source / Function Key | 50 |
| Function Key / Projector Status..... | 51 |
| Network Control Window Introduction..... | 52 |
| Maintenance Of Projector | 53 |
| Air Filter / Replacing the Air Filter | 53 |
| Lamp / Replacing New Lamp..... | 54 |
| Other Care / Cleaning the Lens | 56 |
| Troubleshooting..... | 57 |
| Indicator..... | 57 |
| Error For Machine Defects..... | 58 |
| List of Supported Monitor Displays | 60 |
| Appendix | |
| Interactive Function Operation(Optional) | |

Contents of Your Box

Check-list of your accessories

Please make sure that following items are included in the box, along with the main.

If any items missing, contact your dealer.

1. Projector

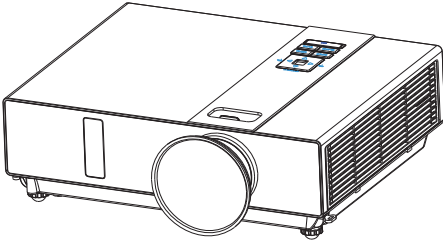

2. Computer cable

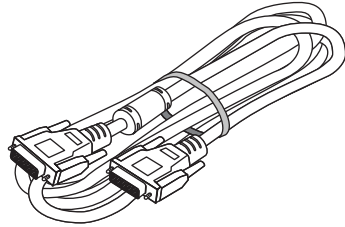

3. Power cord

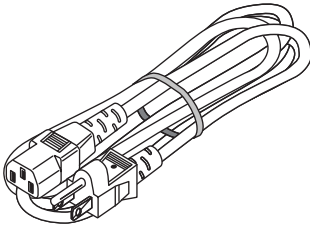

4. Quick Start Guide

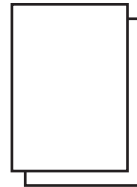

5. Owner's Manual CD

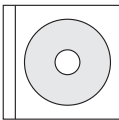

6. Convergence Lens



7. Remote control

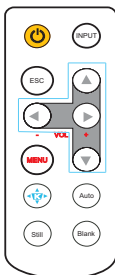

Contents of Your Box

Optional

Remote control



Remote control



USB Cable (1.5M)

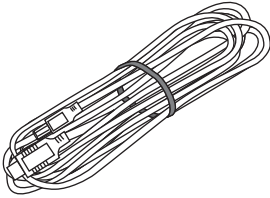

Soft Bag

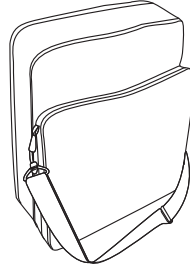

Safety Instructions

The projector is designed and tested to meet the latest standards for safety of information technology equipment. However, to ensure safe use of this product, it is important that you follow the instructions mentioned in this manual and marked on the product.



WARNING / CAUTION

1. If a problem occurs

- If smoke or strange odors arise, continued use could result in fire or electrical shock.
- If there is no image or sound, or the sound is distorted in the projector. In some cases, immediately remove the power cable from the power outlet. After making sure that the unit has stopped, contact your dealer for repairs. Never attempt to repair by yourself because this is dangerous.

2. Do....

- Place the projector in a stable horizontal position.
- Put the projector in a cool place, and ensure that there is sufficient ventilation.
- To consult with your dealer before a special installation such as suspending from a ceiling.

3. Do not....

- Do not place the projector on an unstable, slanted or vibrating surface such as a wobbly or inclined stand.
- Do not cover the projector's vents. Keep a space of 20 cm or more between the projector and other objects such as walls.
- Do not place the projector on metallic goods.
- Do not place the projector on carpet, cushions or bedding. Do not place the projector in direct sunlight or near hot objects such as heaters.
- Do not place anything near the projector lens or vents, or on top of the projector.
- Do not place anything that may be sucked into or stick to the vents beside of the projector.
- Do not use this projector if there is no image or sound, or if the sound is distorted.
- Do not place this projector in a container containing liquid.

4. While connecting, make sure that the shape of the cable's connector fits the port to connect with. Be sure to tighten the screws on connectors with screws.
5. Do not disassemble or modify the projector and accessories.
6. Be careful not to damage the cables, and do not use damaged cables.
7. Use appropriate accessories or otherwise designed cables. Ask your dealer about non-accessory cables that may have other lengths.
8. Make sure that devices are connected to the correct ports. An incorrect connection may result in malfunction or damage to the device and the projector.
9. Do not look through the lens when the lamp is on.

Do not look through the lens when the lamp is on. The powerful light could adversely affect vision. Use special caution in households where children are present.

10. A strong light is emitted when the projector's power on. Do not look into the lens of the projector or look inside of the projector.



NO SIDEWARD

Do not place the projector upon either side to project an image.



NO DOWNWARD

Do not point the projector down to project an image.

Safety Labels

Safety labels are used on or within the projector to alert you to items or areas requiring your attention.

WARNING LABEL

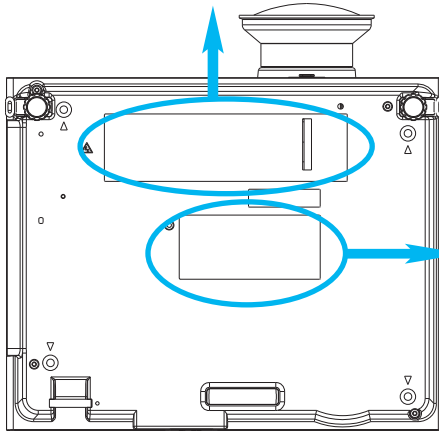

EMI LABEL



LAMP DOOR WARNING LABEL

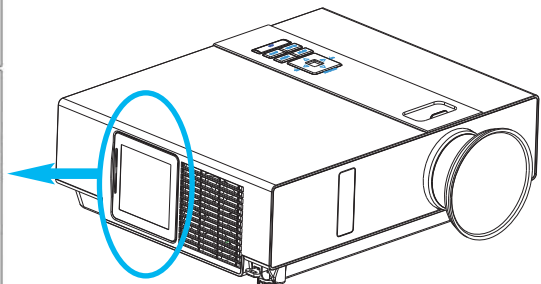

Projector

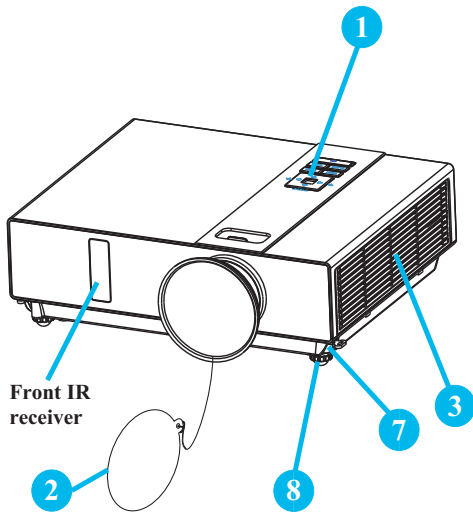

Front IR receiver

1 Control panel

Operating system.

2 Lens cover

Attach when not using to protect the lens from becoming dirty or damaged.

3 Filter cover

Prevents dust and other foreign particles from being drawn into projector.

Remove the filter cover to clean the air filter.

4 Focus ring

Use the focus ring to focus the projector image.

Rotate the focus ring until the image is clear.

5 Zoom ring

Use the zoom ring to adjust the size of the projected image.

Rotate the zoom ring until the image is the desired size.

6 Lamp door

The lamp unit is inside.

7 Foot adjust button

Lock / unlock the adjustable foot.

8 Front adjustable foot

Extend and retract to adjust the projection angle.

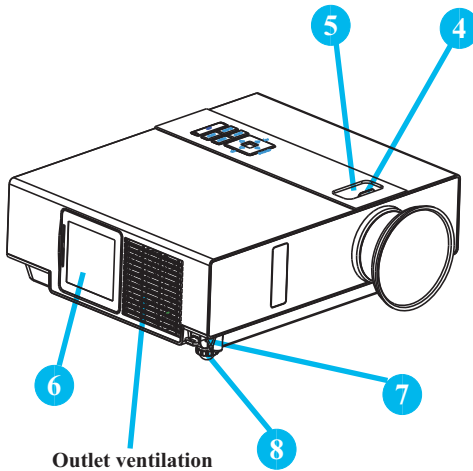

Outlet ventilation

Control Panel

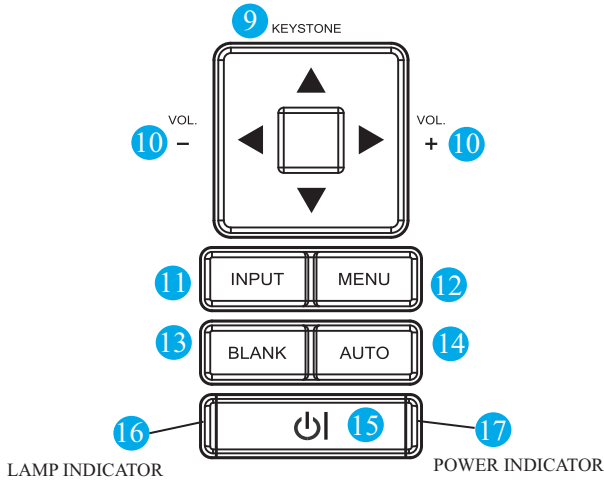

9 KEystone

Adjust the vertical keystone with menu-up, menu-down.

10 VOLUME + / -

Sound louder or lower.

11 INPUT

Select input source:

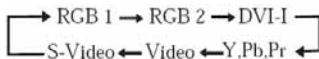

12 MENU

Display or hide the OSD main menu page.

13 BLANK

Blank the projected image. The time of Blank mode can be set in 15 minutes, 30 minutes or 60 minutes. The projector will shut down automatically after passing each set time.

14 AUTO

Automatically adjust the setting to match the current input.

15 (POWER)

Power On / Off.

16 LAMP INDICATOR

Indicates a status in the internal projector temperature, lamp door properly closed or cooling down.

17 POWER INDICATOR

Light on or flash to indicate the operating status of the projector.

Rear

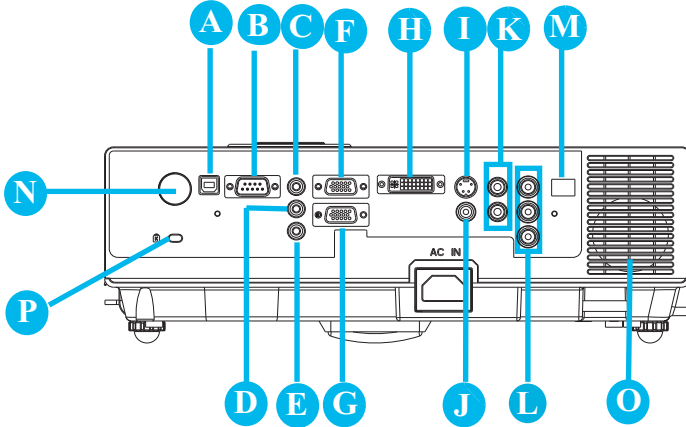

A MOUSE

Connect a USB mouse cable to a computer to control computer mouse functions.

B RS232

Serial data port for controlling the projector with a computer or other RS-232 control device.

C AUDIO IN 1 & D AUDIO IN 2

Mini jack port corresponds to computer input.(RGB IN→AUDIO IN 1, DVI-1 IN →AUDIO IN 2)

E AUDIO OUT

This jack outputs the audio signal from computer signal to external audio equipment.

F RGB IN

Input analog RGB video signal from a computer.

G RGB OUT

Connect an external monitor to this connection to view the "RGB IN" input.

H DVI-I IN

Input digital DVI-I signal from a computer.

I S-VIDEO

S-Video signal from a video source.

J VIDEO

Composite video signal from a video source.

K AUDIO IN 3, R / L

RCA type corresponds to video input.

L COMPONENT /Y, Pb, Pr

Input Y,Pb,Pr signal from a DVD player.

M LAN (Optional)

This function is optional.

Please see page 34 Network Control Application for details.

N REAR IR RECEIVER

O SPEAKER

P Slot for Kensington Micro Saver

Security System

Built-in Security Slot

This security slot supports the MicroSaver® Security System. MicroSaver® is a registered trademark of Kensington Microware Inc.

The logo is trademarked and owned by Kensington Microware Inc.

Setting Up

Arrangement

1. Before installation, make sure that the projector is turned off and the power cord is disconnected.
2. Do not set up and move the projector, while it is hot.
3. The distance between the projector and screen determines the actual image size. Refer to the table below to determine the screen size at a given distance.

Note: The dimensions in the table below are approximate.

| Screen size (diagonal) | | Distance (m) | | Distance (feet) | |
|------------------------|-----|--------------|------|-----------------|-------|
| inch | m | Tele | Wide | Tele | Wide |
| 40 | 1.0 | 0.95 | 0.77 | 3.13 | 2.53 |
| 60 | 1.5 | 1.45 | 1.18 | 4.74 | 3.88 |
| 70 | 1.8 | 1.69 | 1.39 | 5.55 | 4.56 |
| 80 | 2.0 | 1.94 | 1.59 | 6.36 | 5.23 |
| 100 | 2.5 | 2.43 | 2.01 | 7.98 | 6.58 |
| 150 | 3.8 | 3.67 | 3.03 | 12.03 | 9.95 |
| 200 | 5.1 | 4.90 | 4.06 | 16.07 | 13.32 |
| 250 | 6.4 | 6.13 | 5.09 | 20.12 | 16.69 |
| 300 | 7.6 | 7.37 | 6.12 | 24.16 | 20.06 |

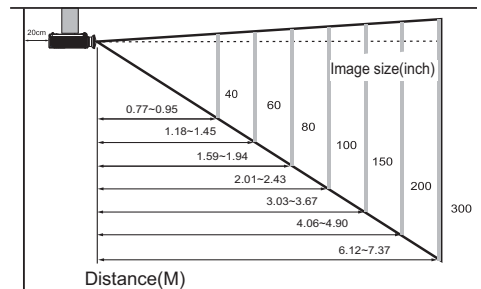
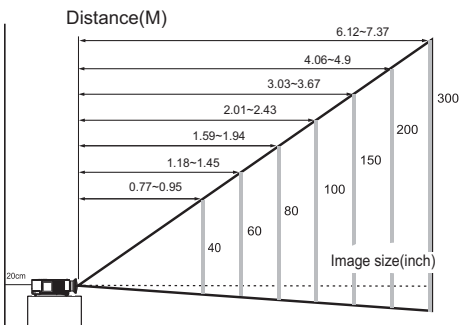

When in against at wall, leave about 20cm (7.9in.) Between the projector and the wall.

Power ON / OFF

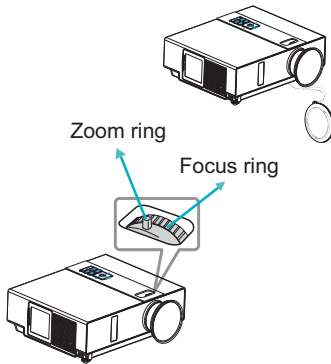
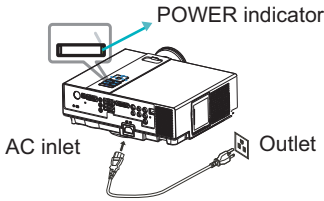

Turning on the power

1. Make sure that power cord is firmly and correctly connected to the projector.
2. Remove the lens cover, and the POWER indicator will light up in green.
3. Press POWER button on the control panel or the remote control to turn on the projector.
4. Rotate the zoom ring to adjust the screen size.
5. Rotate the focus ring to adjust the focus.

WARNING

- ★ A strong light is emitted when the projector's power is on. Do not look into the lens of the projector or look inside of the projector through any of the projector's openings.



Power off?

Please press



key again to power off.

Turning off the power

1. Press the POWER button on the control panel or the remote control. The “power off” confirmation message appears.
2. Press the POWER button again while the message appears.
3. When the projector enters “Standby” mode, the POWER indicator will light up in green.
4. If you don't use the projector, remove power cord.

WARNING

- ★ Do not touch around the lamp cover and the exhaust vents during use or just after use, since it is too hot.

CAUTION

- ★ Do not turn off the AC power for 60 seconds after the lamp is turned on. Doing so could cause premature lamp failure.

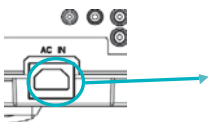
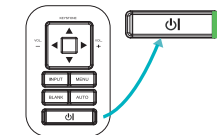

Setting Up The Projector

The projector supports the following four different projection methods.

1. Front projection

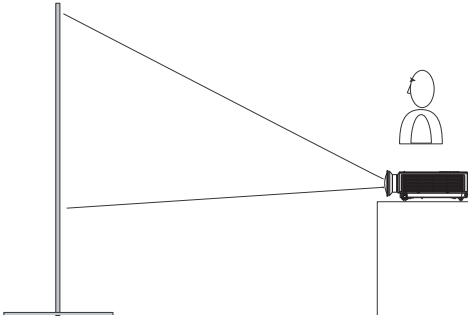

3. Rear ceiling projection

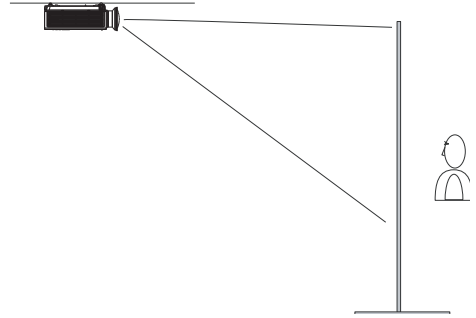

2. Rear projection

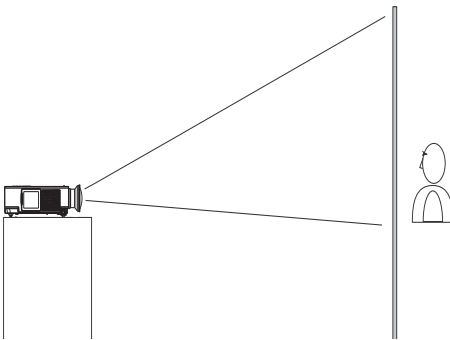

4. Front ceiling projection

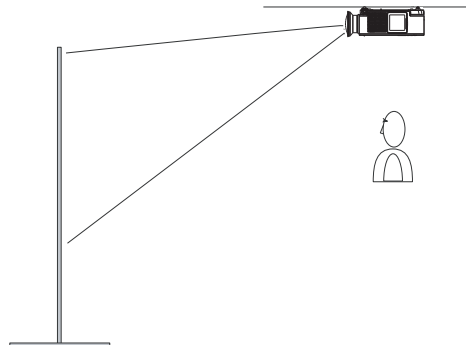

Special installation is required in order to suspend the projector from the ceiling. Please ask your dealer for details.

Ceiling Mounted Installation Guide

Attach ceiling mount at four-suspension bracket fixing points when suspending from a ceiling. Special installation is required in order to suspend the projector from the ceiling. Please ask your dealer for details.

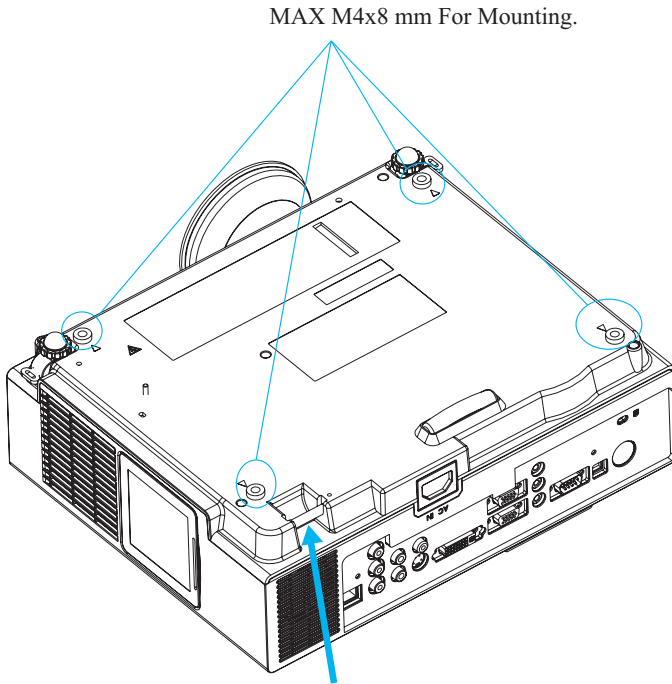

Security Anchor

The product is equipped with security anchor and PIN LOCK functions to help prevent unauthorized removal projector.

WARNING

- ▶ Do not grasp the security anchor to carry projector, since it is not designed for it.
- ▶ The security anchor is not for comprehensive theft prevention measures. It is intended to be used as supplemental theft prevention measure.

Adjusting The Projector's Elevation

Use the adjustable foot at the front of the projector to set the image height.

- 1 Holding the projector, push the foot adjust buttons to loosen the front adjustable foot.
- 2 Position the front side of the projector to the desired height.
- 3 Release the foot adjust buttons in order to lock the front adjustable feet.
- 4 After making sure that the front adjustable feet are locked, put the projector gently atop.

CAUTION

- * The adjustment range of front adjustable foot is 0 to 8.5 degrees.
- * When the foot is adjusted, it may cause the shape of the projected image to become distorted. Use the keystone correction function to correct this distortion.

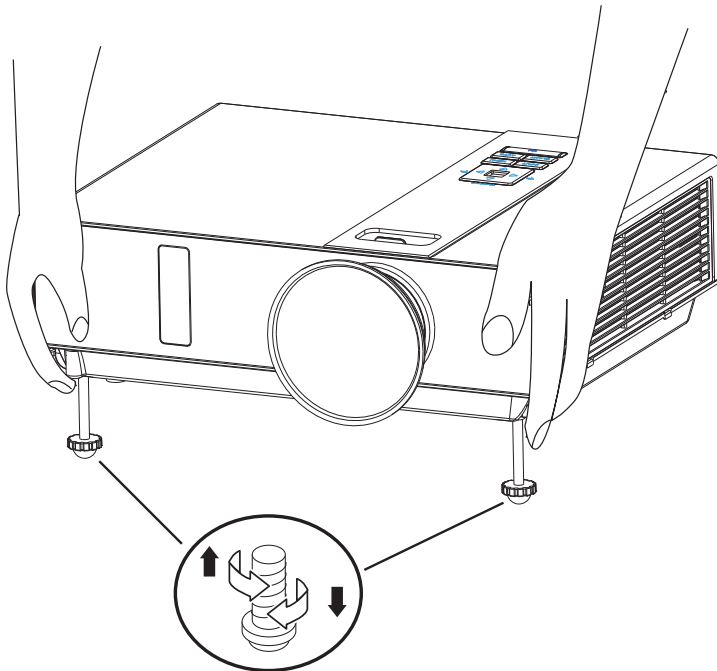

How To Connect

Laptop or desktop computer

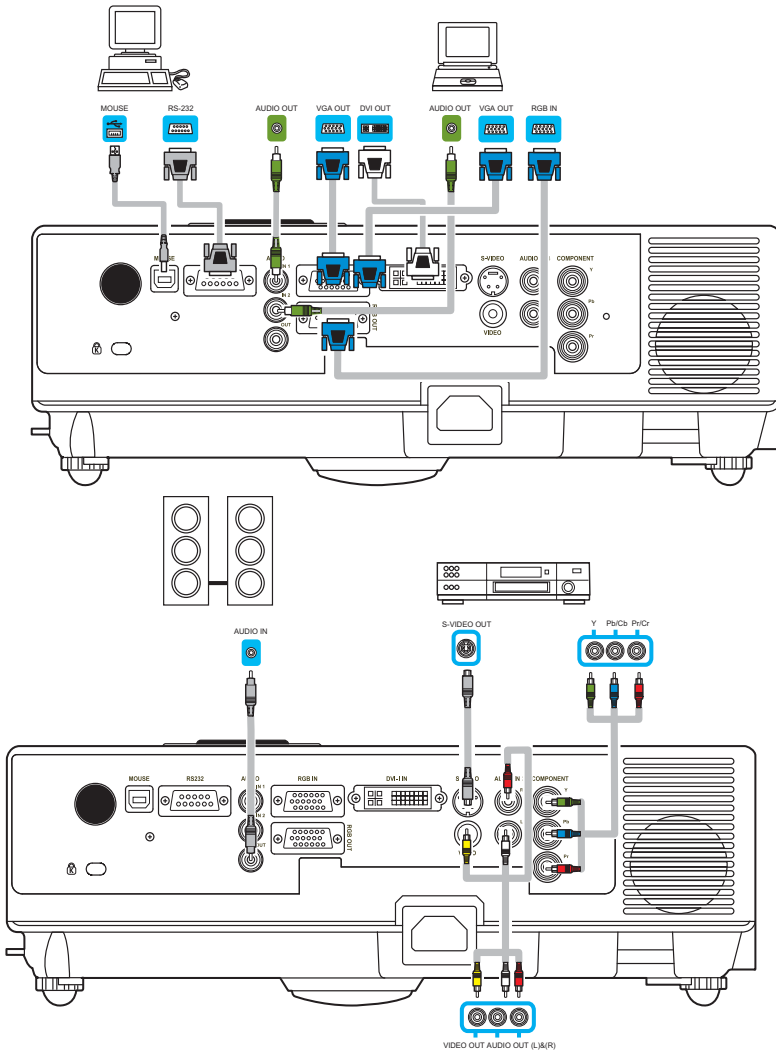

Before starting, make sure that the projector and computer are both turned off.

Connect the computer cable

Connect the computer cable from the computer to the projector's RGB IN or DVI-I IN. If needed, connect the MONITOR OUT to a monitor to view input from RGB IN or DVI-I IN. Tighten the screw on all connectors.

How To Connect

Laptop or desktop computer

Connect the audio cable if necessary

1. Please connect the audio cable to the AUDIO IN 1 if the computer cable connected to the projector's RGB IN.
2. Please connect the audio cable to the AUDIO IN 2 if the computer cable connected to the projector's DVI-I IN.
3. Please connect the audio cable to the AUDIO IN 3 if the video cables are connected to the VEDIO / S-VIDEO / Y,Pb,Pr port of the projector.

Connect USB Mouse

USB mouse compatible MS-Windows 98/ 2000/ NT/ XP/ Me, Macintosh :OS8.6~10.1, and a Microsoft Mouse driver installed.

1. Insert the end of the USB Cable (B-Type) to the projector's USB port.
2. Connect the end of the USB Cable (A-type) to the computer's USB port.
3. When the projector and computer are turned on, the appropriate drivers should load automatically.

 If the selected video image is not displayed after the projector is turned on and the correct video source has been selected, please check that the video source device is turned on and operating correctly. Also check that the signal cables have been connected correctly.

 Many laptops do not turn on their external video ports when connected to a projector. Usually a key combination like Fn + F3 or CRT/LCD key turns the external display on / off. Locate a function key labeled CRT/LCD or a function key with a monitor symbol on the laptop. Press Fn and the labeled function key simultaneously. Refer to your laptop's documentation to discover your laptop's key combination.

Remote Control Battery Installation

1. Remove the battery cover.
2. Load the batteries. Make sure the plus pole is correctly oriented.

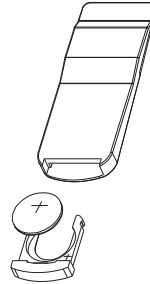

3. Close the battery cover.

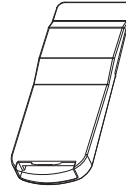

Caution

- ▶ Avoid excessive heat and humidity.
- ▶ Do not drop the remote control.
- ▶ Do not expose the remote control to water or moisture, this could result in malfunction.
- ▶ If the remote control will not be used for an extended period, remove the battery.
- ▶ Replace the battery when remote control operation becomes sluggish or unresponsive.
- ▶ Do not place the remote control close to the cooling fan of the projector.
- ▶ Do not use batteries of different types at the same time.
- ▶ Do not mix a new battery with used one. Make sure the plus and terminals are correctly aligned when loading a battery.
- ▶ Dispose of batteries in accordance with environmental laws.
- ▶ Do not disassemble the remote control. If the remote control needs service, please contact your dealer.

Remote Control

Power

Power on operation mode, standby mode, cool down mode.

ESC

Press “ESC” button to close “Menu” picture.

Volume +/-

Adjust Volume higher or lower.

Menu

Display or hide the On-Screen Display main menu page.

Keystone

Adjust the vertical keystone function.

Still

Keep the current image on the screen.

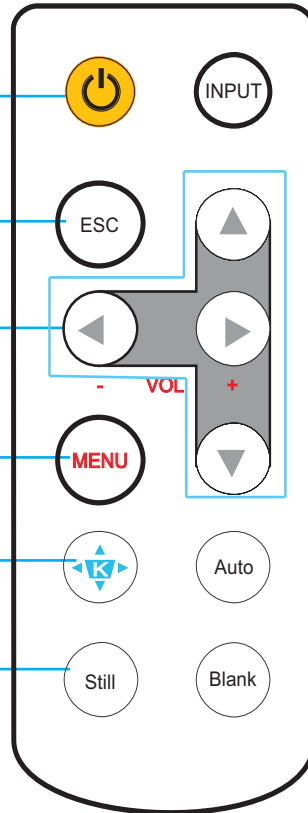

Remote Control

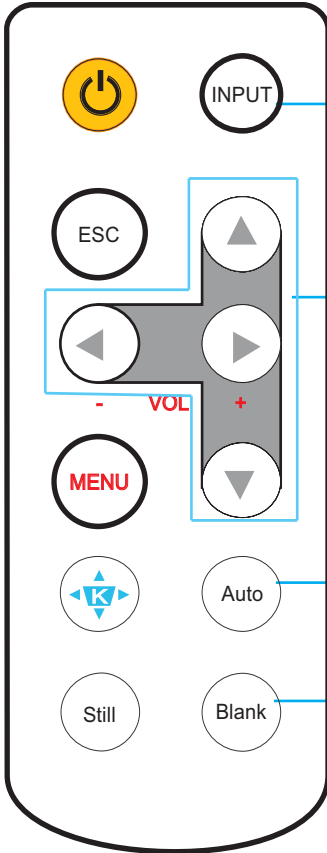

INPUT

Select input source:



Menu up / down Menu left / right

Select and adjust the function of On-Screen Display.

Auto

Refresh the current image.

Blank

Hide the current image, become black color on the screen.

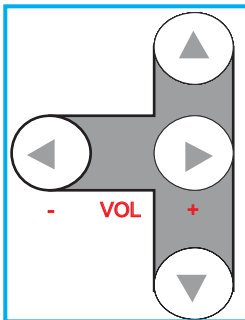

Quick Key:

If it is not in the OSD menu of screen, you could press the buttons as seen on the left.

Press button to select item.

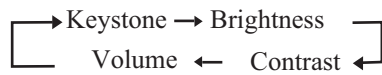

Press button to select item.

Remote Control (Optional)

Remote Control Batteries Installation

1. Remove the battery cover.
2. Load the batteries.
Make sure the poles are correctly oriented.
3. Close the battery cover.

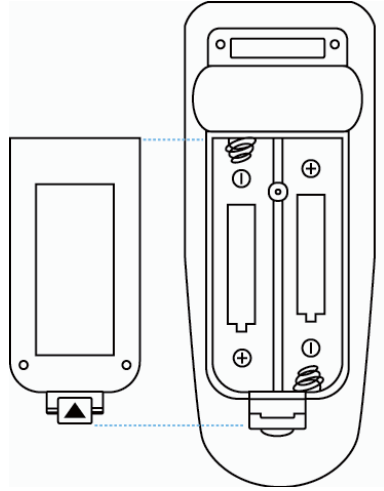

Caution

- ▶ Avoid excessive heat and humidity.
- ▶ Do not drop the remote control.
- ▶ If the remote control will not be used for an extended period, remove the batteries.
- ▶ Do not expose the remote control to water or moisture. This could result in malfunction.
- ▶ Replace the battery when remote control operation becomes sluggish or unresponsive.
- ▶ Do not place the remote control close to the cooling fan of the projector.
- ▶ Do not use batteries of different types at the same time.
- ▶ Do not mix a new battery with used one. Make sure the plus and terminals are correctly aligned when loading batteries.
- ▶ Dispose of batteries in accordance with environmental laws.
- ▶ Do not disassemble the remote control. If the remote control needs service, please contact your dealer.

Remote Control (Optional)

POWER

Power on / operation mode, Standby mode, Cool down mode.

INPUT

Select input source :



MENU

Display or hide the On-Screen Display main menu page.



Press  or  to select On-Screen Display menu item.



Press  or  to select and adjust the function of On-Screen Display menu item or value.

LASER

Aim the remote control at the screen, press and hold button to activate the laser pointer.

MUTE

Mute audio.

AUTO

Refresh the current image.

BLANK

Hide the current image, become black color on the screen.



Press  /  /  /  button to move arrow direction of window.

MOUSE-L / MOUSE-R

The function is like mouse of desktop/ notebook.

Remote control's mouse functions only will work if the USB cable is connected (see page 15 for instructions)

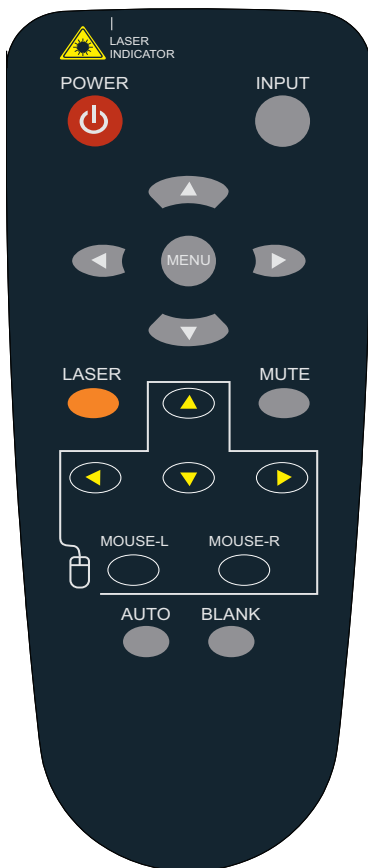

Remote Control (Optional)

Remote Control Batteries Installation

1. Remove the battery cover.
2. Loading the batteries.
Make sure the plus and minus poles are correctly oriented.
3. Close the battery cover.

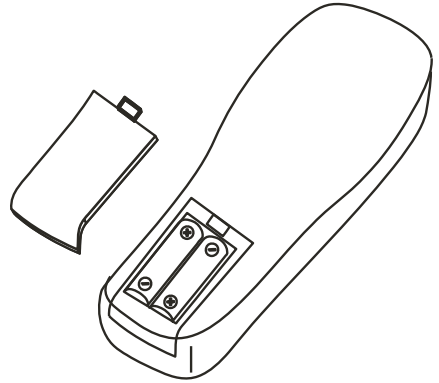

Caution

1. Avoid excessive heat and humidity.
2. Do not drop the remote control.
3. Do not expose the remote control to water or moisture, this could result in malfunction.
4. When the remote control will not be used for an extended period, remove the batteries.
5. Replace the batteries when remote control operation becomes sluggish or unresponsive.
6. Do not place the remote control close to the cooling fan of the projector.
7. Do not disassemble the remote control. If the remote control needs service. Please bring it to the service station.

Remote Control (Optional)

Power

Power on / operation mode, Standby mode, Cooling-down mode.

ESC

Press "ESC" button, it will close "Menu" picture.

Vol +/-

Sound louder or lower.

Menu

Display or hide the OSD main menu page.

Keystone +/-

Adjusts the vertical keystone function.

Still

Keep the current image on the Screen.

Blank

Hide the current image, become black color on the screen.

Auto

Refresh the current image.

Menu up/down, Menu left/right

Selecting and adjusting the function of OSD.

INPUT source

Select input source:

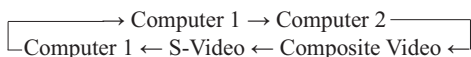

Mouse

Select an item or adjust value in the On-Screen Menu.

Zoom in / Zoom out

Zoom in or zoom out.

Mute

Mute audio.

Laser pointer

Use laser pointer from remote control.

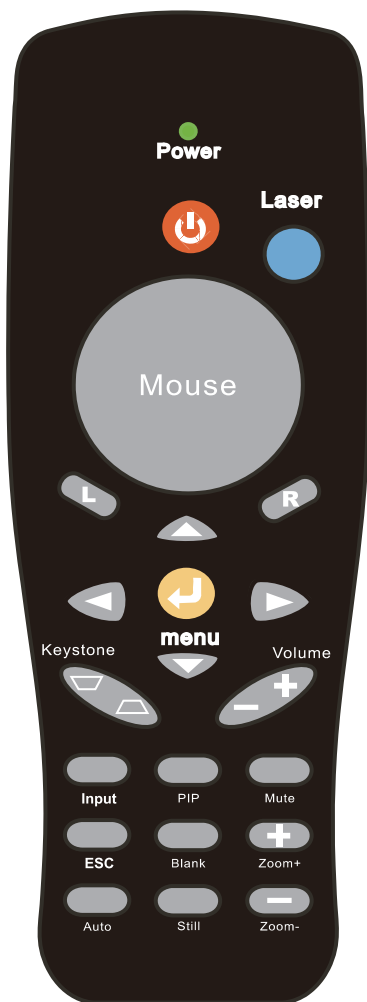

Menu Operation

How To Operate On-Screen Display

1. You could press "Menu" button. It will be shown blue main menu. The first main menu is " PICTURE" menu.
2. Choose which item you want to enter, you could press up / down /left/ right button of control panel or remote control to adjust item or value.

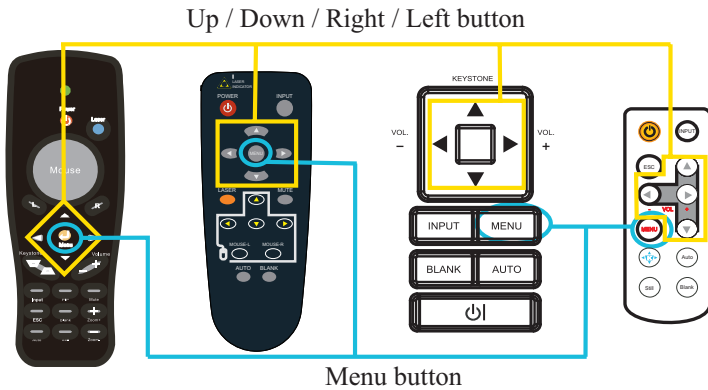
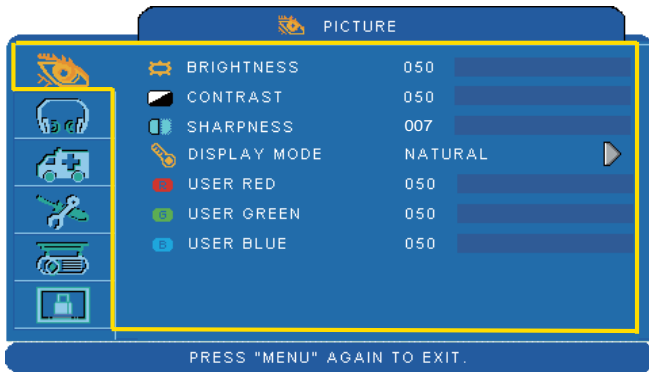

MENU (PC Mode)

Picture Menu

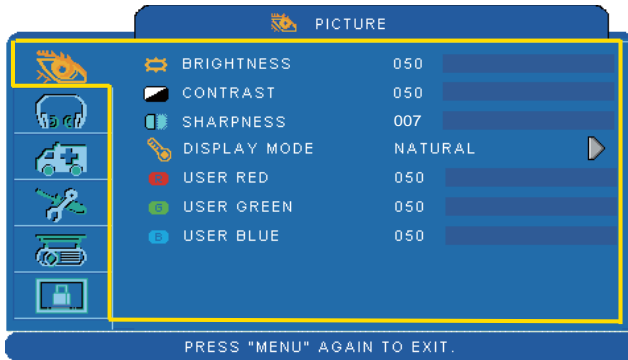

Step:

1. Use the ▲ / ▼ buttons to select an item.
2. Use the ◀ / ▶ cursor buttons to select an item or adjust the value.

| Item | Selection | Description |
|--------------|---|--|
| BRIGHTNESS | 000/100 | Adjust the image brightness level. |
| CONTRAST | 000/100 | Adjust the image contrast level. |
| SHARPNESS | 000/015 | Adjusts the image sharpness. |
| DISPLAY MODE | NATURAL | Natural color. |
| | CINEMA | Enhance contrast ratio when displaying DVD contents. |
| | DAYLIGHT | Suitable when ambient light is strong. |
| | GREEN BOARD WHITE BOARD BLACK BOARD | Adjust the color settings to make the projected image on a (green, white, black) board more visible. |
| | USER | User Red 000/100 User Green 000/100 User Blue 000/100 |

Audio Menu

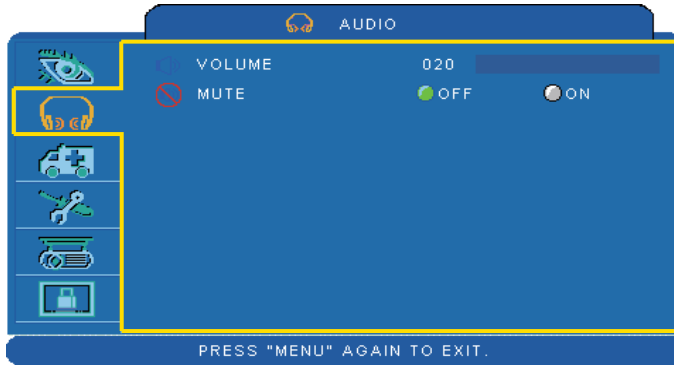

Step:

1. Use the ▲ / ▼ buttons to select an item.
2. Use the ◀ / ▶ buttons to select an item or adjust the value.

| Item | Selection | Description |
|--------|-----------|---------------------------|
| VOLUME | 00/40 | Adjust the volume. |
| MUTE | OFF/ON | Mute the volume OFF / ON. |

Setting Menu

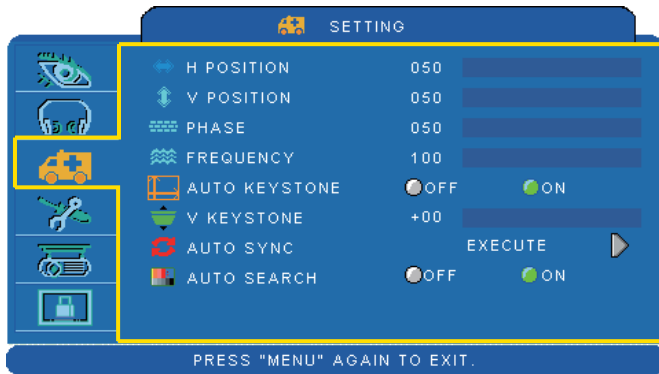

Step:

1. Use the ▲ / ▼ buttons to select an item.
2. Use the ◀ / ▶ buttons to select an item or adjust the value.

| Item | Selection | Description |
|---------------|-----------|--|
| H POSITION | 000/100 | Move the image position horizontally. This function is only selected for computer signal. |
| V POSITION | 000/100 | Move the image position vertically. This function is only selected for computer signal. |
| PHASE | 000/100 | Adjust the image sharpness. |
| FREQUENCY | 000/200 | Set the horizontal scanning frequency. |
| AUTO KEYSTONE | OFF/ON | Correct keystone distortion in image automatically. |
| KEYSTONE V | -70/+70 | Correct vertical keystone distortion in image manually. |
| AUTO SYNC | EXECUTE | Set all of the above setting automatically. |
| AUTO SEARCH | OFF/ON | Search signal source manually or automatically. |

*DVI doesn't support H POSITION, V POSITION, PHASE, FREQUENCY and AUTO SYNC.

MENU (Video Mode)

Picture Menu

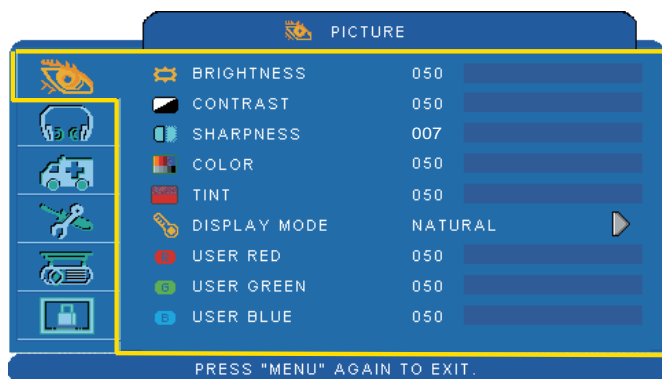

Step:

1. Use the ▲ / ▼ buttons to select an item.
2. Use the ◀ / ▶ cursor buttons to select an item or adjust the value.

| Item | Selection | Description |
|--------------|---|--|
| BRIGHTNESS | 000/100 | Adjust the image brightness level. |
| CONTRAST | 000/100 | Adjust the image contrast level. |
| SHARPNESS | 000/015 | Adjusts the image sharpness. |
| COLOR | 000/100 | Adjust the strength of whole color. This function can be used under video signal, S-Video signal, or component video signal input only. |
| TINT | 000/100 | Adjust the image tint. This function can be used under video signal, S-Video signal, or component video signal. |
| DISPLAY MODE | NATURAL | Natural color. |
| | CINEMA | Enhance contrast ratio when displaying DVD contents. |
| | DAYLIGHT | Suitable when ambient light is strong. |
| | GREEN BOARD WHITE BOARD BLACK BOARD | Adjust the color settings to make the projected image on a (green, white, black) board more visible. |
| | USER | User Red 000/100 User Green 000/100 User Blue 000/100 |

Audio Menu

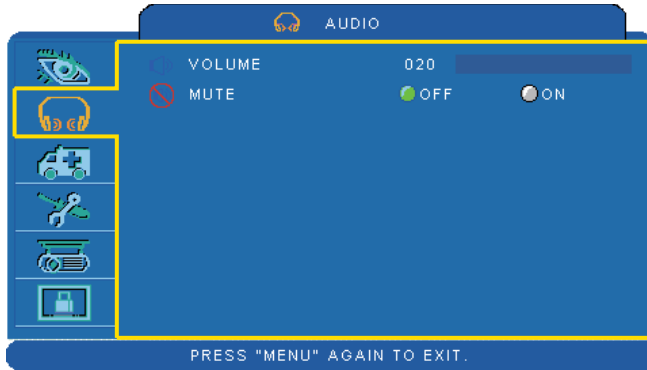

Step:

1. Use the ▲ / ▼ buttons to select an item.
2. Use the ◀ / ▶ buttons to select an item or adjust the value.

| Item | Selection | Description |
|--------|-----------|---------------------------|
| VOLUME | 00/40 | Adjust the volume. |
| MUTE | OFF/ON | Mute the volume OFF / ON. |

Setting Menu

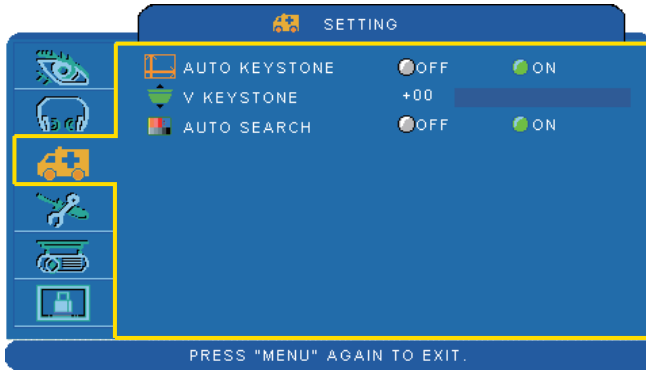

Step:

1. Use the ▲ / ▼ buttons to select an item.
2. Use the ◀ / ▶ buttons to select an item or adjust the value.

| Item | Selection | Description |
|---------------|-----------|---|
| AUTO KEYSTONE | OFF/ON | Automatically Correct keystone distortion in image. |
| KEYSTONE V | -70/+70 | Correct vertical keystone distortion in image manually. |
| AUTO SEARCH | OFF/ON | Search signal source manually or automatically. |

Advanced Menu

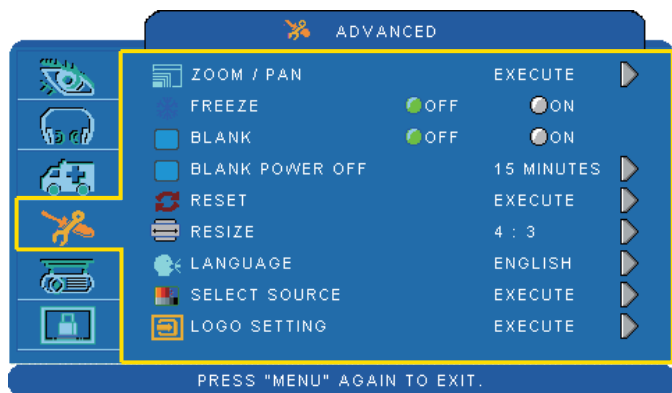

Step:

1. Use the ▲ / ▼ buttons to select an item.
2. Use the ◀ / ▶ buttons to select an item or adjust the value.

| Item | Selection | Description |
|-----------------|-----------------|--|
| ZOOM / PAN | EXECUTE | Execute digital zoom and pan function. |
| FREEZE | OFF/ON | Freeze the current image on the screen. |
| BLANK | OFF/ON | Hide the image, display a black screen. |
| BLANK POWER OFF | 15/30/60 Minute | Set power off time after blank. |
| RESET | EXECUTE | Reset all menu function to their factory default values. |
| RESIZE | | 4:3, 16:9, 1:1 |
| LANGUAGE | ENGLISH | Select the language that the menu and on screen message is display in English → 繁體中文 → 简体中文 → 日本語 Deutsch ← Français ← Nederlands ← 한국어 Italiano → Polski → Português → Русский Suomi ← ไทย ← Українська ← Svenska ← Español |
| SELECT SOURCE | EXECUTE | Select the input source from: RGB 1 → RGB 2 → DVI-I S-Video ← Video ← Y, Pb, Pr |
| LOGO SETTING | EXECUTE | Customize the start-up logo. |

Advanced Menu



LOGO SETTING

This function allows you to customize the start-up logo.

IMPORTANT:

To implement Logo setting function, please enter PIN code first. Without inputting the PIN code, you cannot modify Logo setting function.

| Item | Selection | Description |
|--------------|------------------------|--|
| LOGO MODE | DEFAULT | Select Mode(► cursor button) |
| | USER | The factory logo. |
| | OFF | The image you captured. The blank image. You can select color with background function. |
| LOGO CAPTURE | EXECUTE | Start to capture the image.(PC mode only) |
| BACKGROUND | BLACK BLUE WHITE | Set background color. |
| LOGO SIZE | ORIGINAL FULL | Display the captured image in original size and put in the center of the screen. Expend the image to full screen. |

Advanced Menu

Logo Capture

How to use this function?

- ① Select Logo Capture item in the logo setting menu, and press ► button.
- ② You can see the red frame to select captured area.
- ③ Use 4 direction buttons to adjust the position of the frame.
- ④ Press “MENU” to start capturing and display a dialog.

②

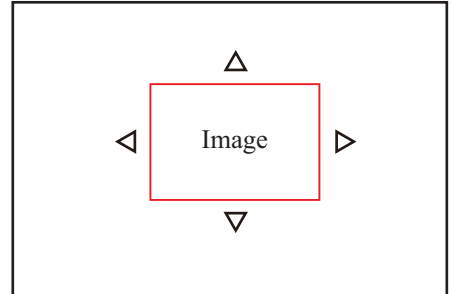

④

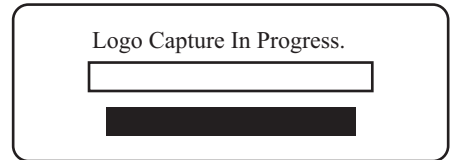

NOTE ► To capture an image is available only in computer mode.
 ► The area that can be captured is 512 x 384 dots.

Presentation Menu

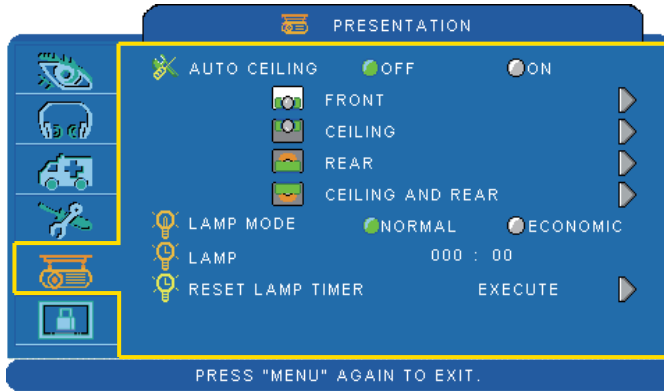

Step:

1. Use the ▲ / ▼ buttons to select an item.
2. Use the ◀ / ▶ buttons to select an item or adjust the value.

| Item | Selection | Description |
|------------------|-------------------|---|
| AUTO CEILING | OFF / ON | Automatically invert the image when the projector is turned upside down, i.e. when the projector is mounted on the ceiling. |
| FRONT | EXECUTE | Normal projection mode. |
| CEILING | EXECUTE | Mirror the image vertically, only for the projector mounted upside down. |
| REAR | EXECUTE | Mirror the image horizontally, only for projecting onto rear projection screen. |
| CEILING AND REAR | EXECUTE | Mirror the image horizontally and vertically. Projecting onto a rear projection screen while projector is upside down. |
| LAMP MODE | NORMAL / ECONOMIC | Switch lamp mode between normal or ECO mode. |
| LAMP | | Show lamp use time. |
| RESET LAMP TIMER | EXECUTE | After changing a new lamp, execute this function to reset the lamp timer. |

Presentation Menu

Reset Lamp Timer

The lamp timer is the time counted after the last resetting. The usage time of the lamp is shown in the PRESENTATION Menu. Pressing the RESET button or the ► button displays a dialog.

To reset the lamp time, select the RESET using the ► button.

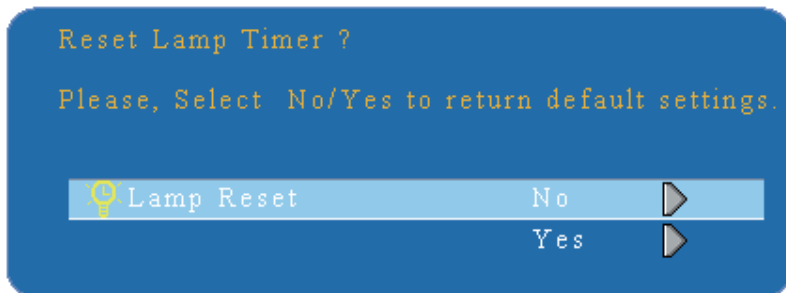

NOTE

- The replacement warning message is set to appear after about 2000 hours of lamp use in order to maintain the initial brightness. When replacement message appears, replace the lamp with a new one as soon as possible, even if the lamp is still workable.

Security Menu

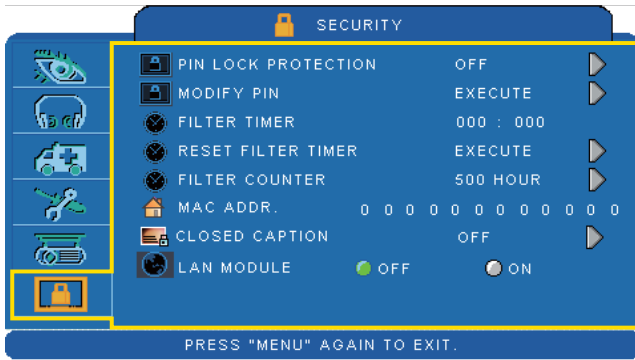

Step:

1. Use the ▲ / ▼ buttons to select an item.
2. Use the ◀ / ▶ buttons to select an item or adjust the value.

| Item | Selection | Description |
|---------------------|---------------------|--|
| PIN LOCK PROTECTION | OFF ON 1 ON 2 | <p>OFF: Turn off PIN lock protection. ON 1: After plugging in AC power, you need to key in PIN code at the first time of use. If the AC power stays unplugged, you do not need to key in PIN code next time when you use the projector. ON 2: You need to key in PIN code every time when you turn on the projector.</p> <div style="border: 1px solid black; padding: 5px;"> <p>⚠ CAUTION: Once the PIN code had been set, the projector cannot be used unless you enter the correct PIN code.</p> </div> |
| MODIFY PIN | EXECUTE | <ol style="list-style-type: none"> 1. Press " MENU " on the projector or remote control. 2. Use the ▶ button to select the MODIFY PIN item of the SECURITY category. 3. Press the ▶ button to change PIN LOCK PROTECTION mode. 4. Please enter the original PIN code. <ol style="list-style-type: none"> (a) If the PIN is correct, system will allow you to change a new PIN code. (b) If the PIN is incorrect, a " Code Error " message will appear. 5. Please enter a new PIN code. And then enter again to confirm. <div style="border: 1px solid black; padding: 5px;"> <p>NOTE: (1) To change the PIN lock protection state, you must enter the PIN code first. (2) Please enter: 0000 for first-time use. (3) To avoid unnecessary trouble, if you activate the [PIN Lock Protection], it is highly recommended that you write down the PIN code and store it in a safe place.</p> </div> |

Security Menu



Step:

1. Use the ▲ / ▼ buttons to select an item.
2. Use the ◀ / ▶ buttons to select an item or adjust the value.

| Item | Selection | Description |
|--------------------|--|--|
| FILTER TIMER | | Show the filter use hour. |
| RESET FILTER TIMER | EXECUTE | Reset the filter timer after cleaning / changing filter. |
| FILTER COUNTER | 500 hours 800 hours 1000 hours | Select (500 / 800 / 1000 hours) depending on the environment.(default : 500 hours). Please see as below. |
| MAC ADDR. | | If purchasing LAN control module, "MAC ADDR." will be shown in "Security" Menu. MAC address stands for unique Media Access Control address of LAN control module and displays with six groups of two hexadecimal digits. |
| CLOSED CAPTION | OFF(Default) C.C1 C.C2 C.C3 C.C4 T1 T2 T3 T4 | The Closed Caption function intimates the sound effects, dialogue, and narration in the content of the television program or video source. Caption (C.C1~C.C4) : Display closed caption Text (T1~T4) : Display text data, which is for additional information such as news reports or a TV program guide. NOTE : This function is available only in video / S-Video source. |
| LAN MODULE | OFF ON | If purchasing LAN control module, "LAN MODULE" will be shown in "Security" Menu. Select ON/OFF to turn on/off LAN control feature. |

Auto Filter Alert

Auto Filter Alert is in SECURITY category to show the air filter use time and alert user to change filter. Pressing ► cursor button will display a dialog. When the operating time reaches the set time, a warning message will appear on the screen to remind user of filter cleaning / replacing.

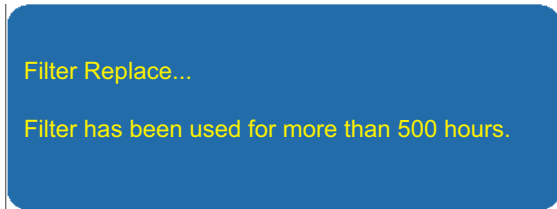

NOTE

► Please reset the Filter time only when you replace the filter.

PIN Key In Operation

When the projector is turned on and the PIN LOCK PROTECTION is set to [ON], the image will show as on the right side.

1. Press the MENU button on the projector or remote control. Enter PIN code by keypad or remote control.

2. How to enter a PIN code?

You can use control panel or remote control.

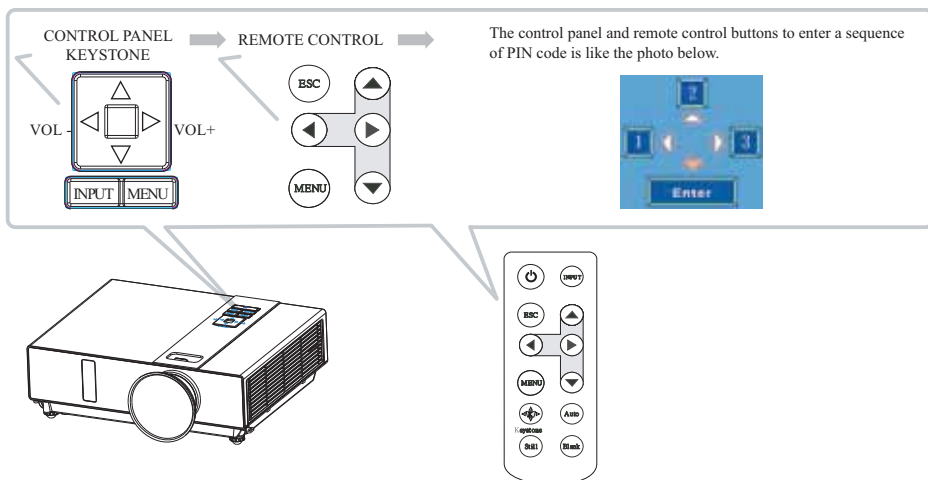
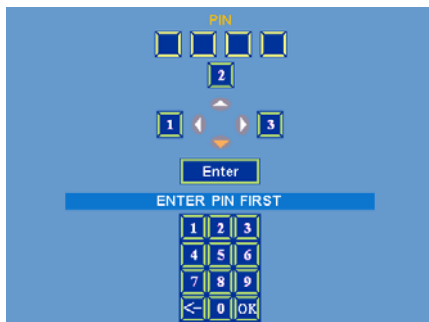

- (1) Press ◀ button: Select the [1]
- (2) Press ▲ button: Select the [2]
- (3) Press ▶ button: Select the [3]
- (4) Press ▼ button: Select the [Enter] move to next row.(4~6,7~9, ◀~OK)
- (5) Press ◀ (backspace) item:
In case you enter a wrong digit, select ◀ to delete the wrong digit you entered.
- (6) Press OK item:
Once all four digits of the PIN are entered, select OK to confirm.

NOTE

If the PIN is incorrect, a ' Enter new code '' message will be shown. Please try again. If the PIN code input is incorrect for three times, a warning message will show up and the projector will shut itself down in 30 seconds.

If you have no idea about the PIN, please contact your dealer for help.

Network Control Software Application

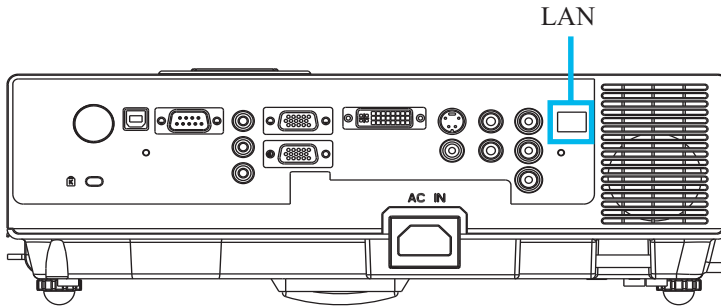

NOTE: This Network Control Software Application is an optional function and support model with RJ45 LAN port only.

- ① Register the projector(s) which needs to be controlled.
" Auto search " can help you to seek the projector(s) source easily.
After registering in the work group, you can start to control the projector.
- ② Group the projector(s) into different sections.
You can monitor the status easily by the sort of group name function in the network.
- ③ Monitor the status for each projector.
 - a. You can manage and change the monitoring content by System Parameter Setting.
 - b. The Lamp timer, filter working time or system warning feedback etc. can be known by checking the status for projector(s).
- ④ Control the booked projector(s).
The status can be refreshed and acquired by monitoring functions; you can also operate the function easily by Network Control.

NOTE

To monitor and control the projector(including stand-by mode), the following conditions need to be ready:

- (1) Projector should already be powered on.
- (2) Projector is connected to network.
- (3) LED light of the projector network port shows normal. (Green light on, Orange twinkle)

* Stand-by mode indicator: Green LED (Power) on the projector's control panel flashes.

Before Use

Before To Use Network Control Software

- ❶ If the system is Windows 2000, NT 4.0 or XP, the PC should be started by the Administrator.
- ❷ Before starting the Network Control software, please check the following.
 - (1) The computer must have Network Control software installed.
 - (2) The projector should be powered on and the LAN wire is well connected to projector.
 - (3) The LAN module ON/OFF item in SECURITY menu of OSD should be setting ON.
 - (4) Make sure the computer and projector can connect to network. Network Control software needs to arrange in TCP/IP network communication and the network cable.

Open Network Control Software

- ❶ Click Network control software icon.



- ❷ Monitor window will show as Graph 1.

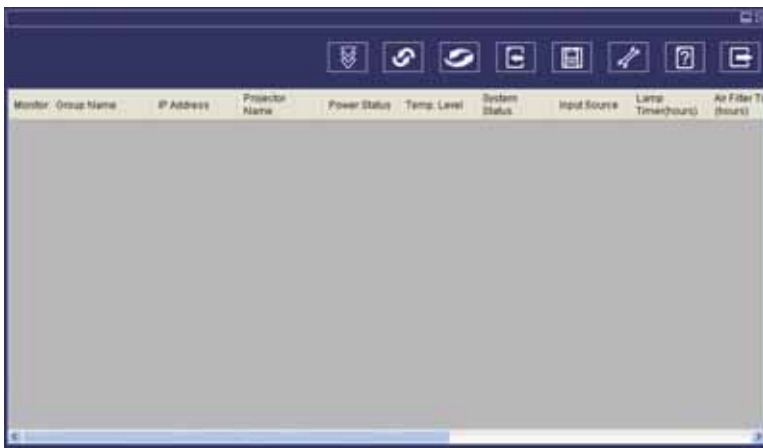

<Graph 1>

Before Use

Projector Auto Search.

- 1 Click the  (Projector search), located projector will show on the network correctly. (Graph2)

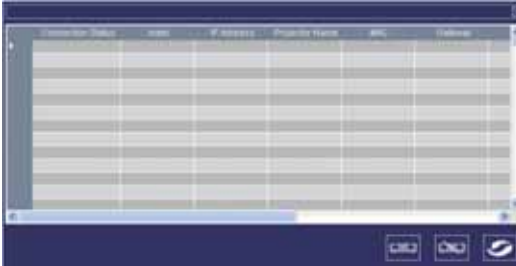

<Graph 2>

NOTE

When the security warning window appears while Network Control is executing, please select "Unblock" to decontrol area network linking against from System Administrator.

- 2 Click  (search again), the projector which is well connected with a PC will be shown. (Graph3)

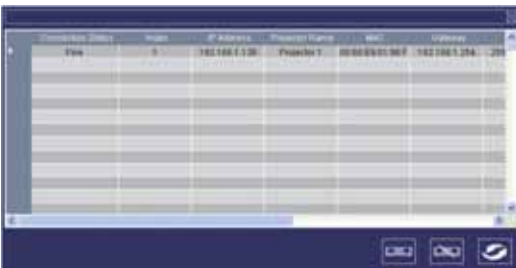

<Graph 3>



NOTE

If there is no projector found on the display window, the following maybe the causes:

1. There is no DHCP server available on the LAN. The LAN module is shipping with DHCP-configured client enabled in default.
2. If there is no DHCP server available on the LAN. The LAN module default IP address should be 169.254.1.1. Please modify the PC/Laptop IP address setting to make the PC/Laptop IP address located on the same segment as 169.254.xxx.xxx and try again.

Before Use

Projector Auto Search.

- Click  (register projector), the projector information will show on the monitor window. Click  button (exit), it will cancel the registered item then return to register table.



<Graph 4-1> Monitor window

- Projector Auto Search can rank group names or display names by clicking the monitor window title (Group Name) or (Projector Name). This will help you easily to understand projectors status.

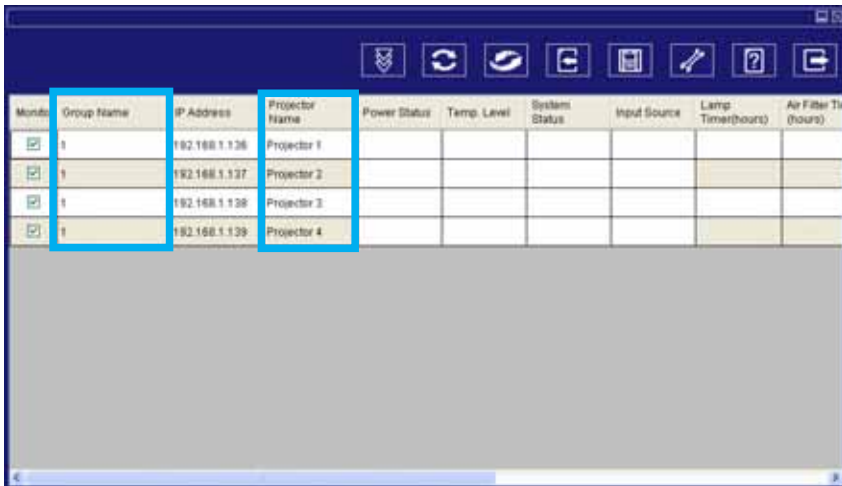



| Monitor | Group Name | IP Address | Projector Name | Power Status | Temp. Level | System Status | Input Source | Lamp Time(hours) | Air Filter Time(hours) |
|-------------------------------------|------------|---------------|----------------|--------------|-------------|---------------|--------------|------------------|------------------------|
| <input checked="" type="checkbox"/> | 1 | 192.168.1.126 | Projector 1 | | | | | | |
| <input checked="" type="checkbox"/> | 1 | 192.168.1.127 | Projector 2 | | | | | | |
| <input checked="" type="checkbox"/> | 1 | 192.168.1.128 | Projector 3 | | | | | | |
| <input checked="" type="checkbox"/> | 1 | 192.168.1.129 | Projector 4 | | | | | | |

<Graph 4-2>

Before Use

Projector Auto Search.

- 5 After registering, you can click  button (Data single capture) in the tool bar or click  button (Start Auto Scan) running in this program to monitor the projector.

NOTE

When pressing  "About" button for help, you will see icons explained as in the chart.



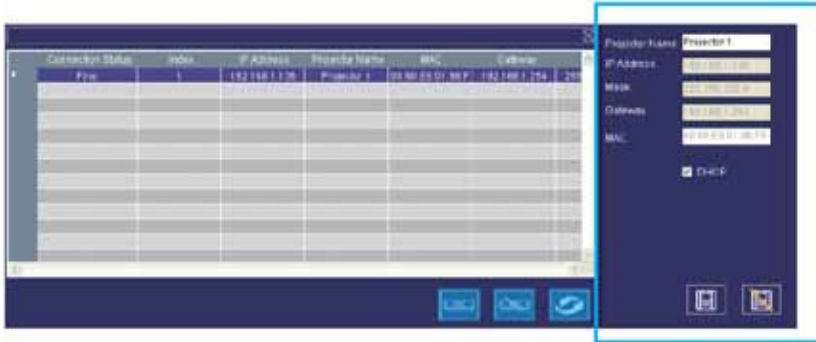

Modify The Projector Setting

- 1 If modifying the registered projector setting is needed, please move your cursor to the data table and click the item that you would like to modify, the detail will be shown on the right side table.



< Graph 5 > : Register Table.

- 2 After setting, you can save the data by clicking  button or cancel by clicking  button.

| Item | Description |
|--------------|---|
| Display name | Show the Host name (16 characters at most in ASCII) |
| IP Address | Show the IP Address |
| Mask | Show the Mask |
| Gateway | Show the Gateway |
| MAC | Show up the MAC code (The default value can not be modified) |
| DHCP | Capture IP address from network sensor automatically. |

< Table 1 > : Setting Windows

Registering And Configuring The Projector

Delete

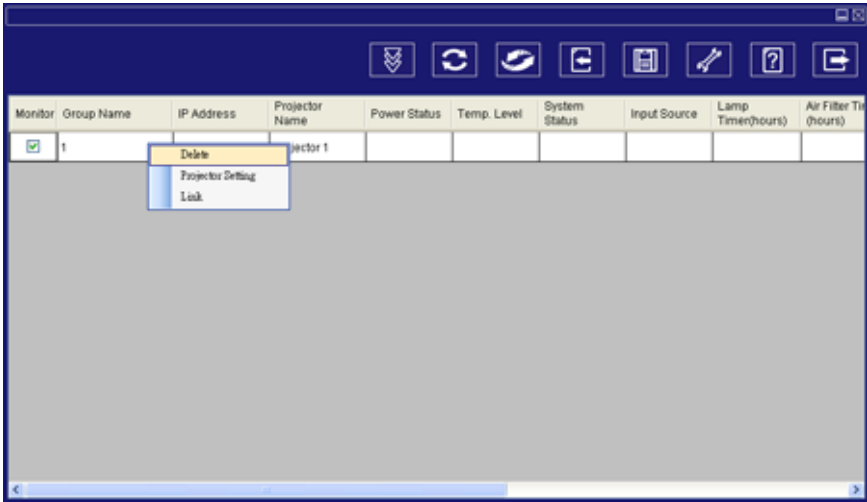

- 1 Select the registered projector in monitor window. Click mouse right key and select " Delete " to erase the registered projector data.



< Graph 6 > : Register Table.

Registering And Configuring The Projector

Projector Setting

- 1 Select the registered projector in monitor window. Click mouse right key and select “ projector setting ” to modify the registered projector data. After finishing the setting, you can save by clicking  button or cancel by clicking  button.

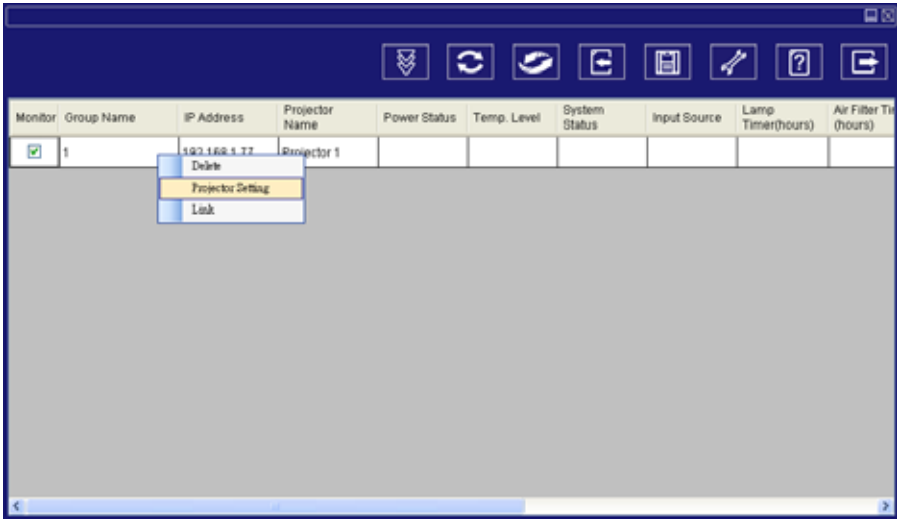

< Graph 7 > : Register table.

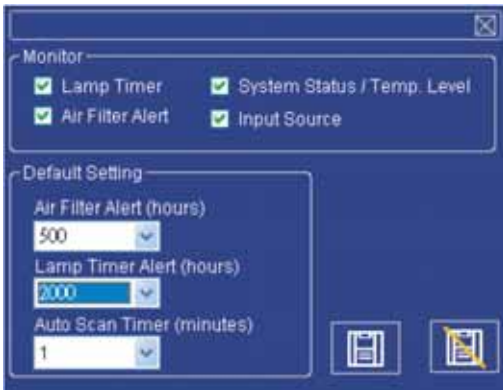

< Graph 8 > :Setting table.

Registering And Configuring The Projector

Projector Setting

- Click  button (system setting) to modify system alert setting.

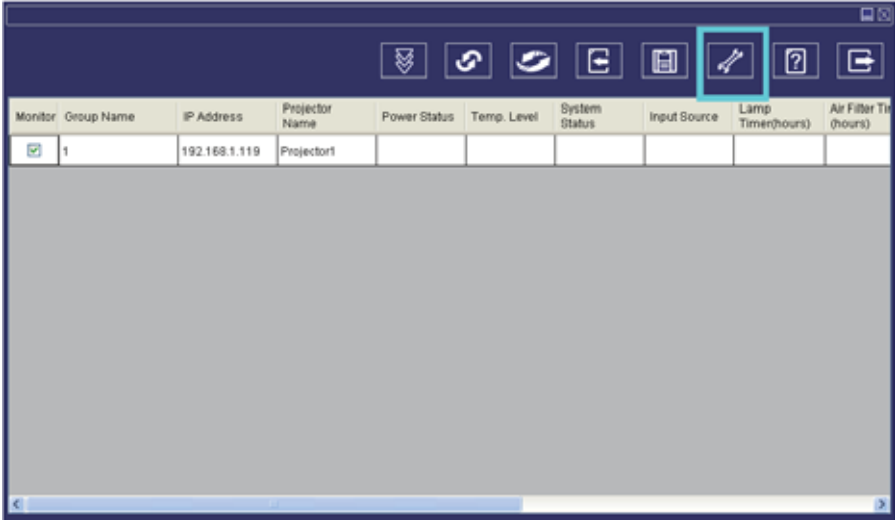

< Graph 9 >

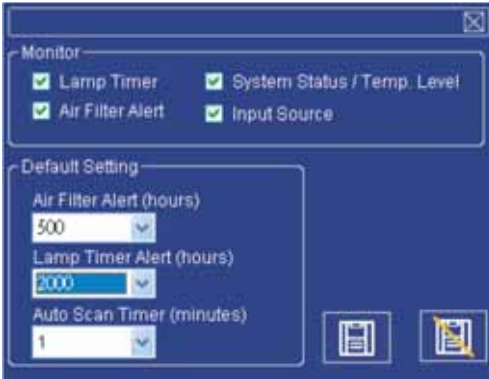

<Graph 10>

Registering And Configuring The Projector

System Setting

Monitor

| Item | Description |
|-------------------------------------|---|
| Lamp Timer | Lamp timer from projector. |
| Air Filter Alert | Air Filter Timer from projector. |
| System Status/ Temperature Level | System Status and Temperature. Level from projector in Power On status. |
| Input Source | Input Source from projector in Power On status. |

< Table 2 >

Default Setting

| Item | Description |
|-----------------------------|--|
| Lamp Timer Alert (Hr.) | Default Setting Includes 1000/1500/2000 Hours. When Lamp Timer reach alert target, window will show lamp timer in red color to remind user to replace the lamp. |
| Filter Timer Alert (Hr.) | Default setting includes 300/500/800/1000/1500 Hours. When Filter Timer reach alert target, window will show filter timer in red color to remind user to replace the filter. |
| Auto Detect Timer (minutes) | Auto Detect setting. Default setting includes 1/3/5/10 minutes; user can set the optimal default listed in Table 4. |

< Table 3 >

Auto Detect Optimal Setting

| Projector Number (Sets) | Timer Interval (Minutes) |
|-------------------------|--------------------------|
| 1~25 | 1/3/5/10 |
| 26~50 | 3/5/10 |
| 51~100 | 5/10 |
| 101~255 | 10> |

* The maximum quantity of projector monitored is 255.

< Table 4 >

Registering And Configuring The Projector

Link



- 3 Select the registered projector in monitor window. Click mouse right key and select “Link ” to show up the control panel table and the projector connected status.









< Graph 12 > : The control panel table

Control Panel Window Introduction















1 Power Control

| Icon | Name |
|---|-----------|
|  | Power on |
|  | Power off |

2 Input Source





| Icon | Name |
|---|---------------------|
|  | Video |
|  | S-Video |
|  | Y,Pb,Pr |
|  | DVI-I |
|  | RGB 1 |
|  | Change Input Source |

3 Function Key





| Icon | Name | Icon | Name |
|---|-----------|---|-----------------------|
|  | Up |  | Freeze |
|  | Down |  | Blank |
|  | Left |  | Keystone Correction + |
|  | Right |  | Keystone Correction - |
|  | Menu |  | Increase Brightness |
|  | Auto Sync |  | Decrease Brightness |
|  | Mute |  | Higher Contrast |

Control Panel Window Introduction

3 Function Key











| Icon | Name |
|---|----------------|
|  | Lower Contrast |
|  | Zoom In |
|  | Zoom Out |
|  | Volume Up |
|  | Volume Down |

4 Projector Status

| Icon | Name |
|---|---------------------|
|  | System Status |
|  | Input Source Status |
|  | Lamp Timer |
|  | Air Filter Timer |

Control Panel Window Introduction

1 Network Control Window introduction

| Icon | Name | Description |
|---|--------------------|---|
|  | Scan all | Capture the all registered projectors' information one time only. |
|  | Start Auto Scan | According to the system setting, get the projector information automatically. |
|  | Stop Auto Capture | Stop scanning the projector information. |
|  | Auto Search | Search the projector in the same network to register and modify the setting. |
|  | Open Project File | Open project file which was saved. |
|  | Save Project File | Save the registered projector in this project. |
|  | System Setting | Setting the projector system reminder message. |
|  | About | Icon content description. |
|  | Exit | Exit the Network software. |
|  | Register projector | Register projector's information. |
|  | Exit | Cancel registered information. |

Air Filter

When a warning message appears to remind you to clean the air filter, please replace a new one as soon as possible. Please check and clean the air filter periodically.

Replacing the Air Filter

When the use time reaches the filter counter time, the projector will display a message that indicates to replace a new filter. If there is no spare air filter available, please contact your dealer.

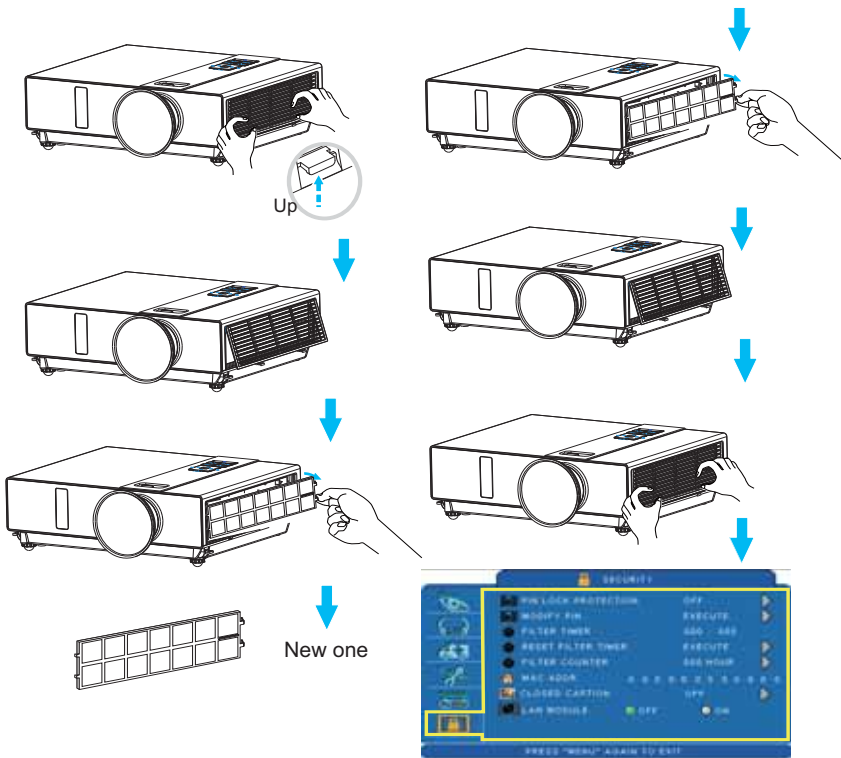

Turn off the projector, and unplug the power cord. Allow the projector to sufficiently cool down.

- 1 Remove the filter cover from the right side of projector.
- 2 Pull out the air filter.
- 3 Install a new air filter.
- 4 Put the filter cover on.
- 5 Reset filter timer after cleaning or changing air filter. (P.35)

Maintenance of Projector

Lamp

1. If you want to replace new lamp, but the projector was just turned off, please let the projector cool down and unplug power cord at least 60 minutes.
2. If the projector is mounted in the ceiling, contact your dealer to replace the lamp.

Replacing New Lamp

1. Remove the lamp door.
2. Loosen 2 screws of the lamp holder. Take the handle on the top of the lamp, pull out the lamp straight off the projector.
3. Insert new lamp, lock the lamp door firmly with 2 screws.
4. Put the lamp door on.
5. Please reset the lamp timer after replacing lamp. (P.34)

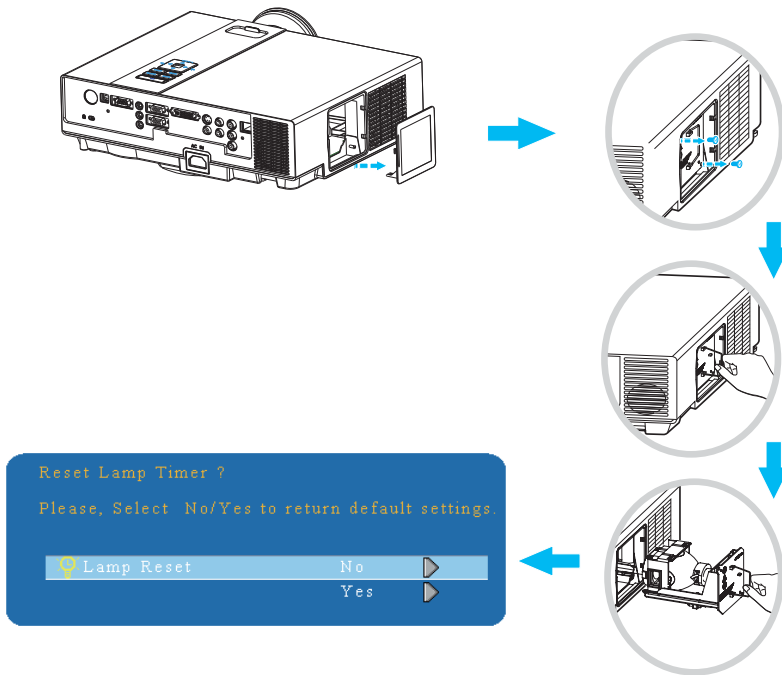

Maintenance of Projector



WARNING

The projector uses a high-pressure mercury lamp.

The explosion of lamp with a loud bang or burn out could possibly cause injury or a fire.

When the bulb bursts, it is possible for shards of glass to fly into the lamp housing; and for gas containing mercury to escape from the projector's vent holes.

If the lamp has broken, do not check the inside of the projector. Please ventilate the room immediately.

Do not touch or bring your face close to the broken pieces since it might get into your eyes or mouth. In case of injury, seek medical advice immediately.

Disposal of a Lamp

Dispose of a lamp in accordance with the local recycling laws.

Do not put it to your trash.

Recycling Lamp's laws of the USA, go to www.lamprecycle.org.

Recycling Product's laws of USA, go to www.eiae.org.

Recycling Product's laws of Canada, go to www.epsc.ca.

For more information about recycling laws, please contact local government agency or dealer.

CAUTION HOT

Before replacing the Lamp part, pay attention to the following items:

1. The Lamp is optional part. Contact the dealer for replacement lamp.
2. The lamp becomes very hot when in use. Turn the power off and disconnect the power cord.
3. Wait 1 Hour before replacing the lamp.
4. Do not use old lamp part.

Other Care

Cleaning The Lens

If the lens is dirty and dusty, display quality maybe decreased. Before cleaning the lens, please make sure that the projector is cool down adequately.

After the projector has cooled down adequately, lightly wipe the lens with the available lens-cleaning cloth.

Do not touch the lens directly with your hand.

Additional

-In order to ensure the safe use of your projector, please contact your dealer to inspect about once a year.

-Before maintenance, make sure the power cable is unplugged, allow the projector to cool sufficiently. The high temperature state of the projector could cause a burn in and/or malfunction to the projector.

-Never try to maintain the inside of the projector by yourself.

Troubleshooting

Indicator

The power and lamp indicators show the status of the projector. Before requesting repair, check the projector status using the chart below. If the problem cannot be resolved, contact your dealer.

In normal status~~~

| POWER | LAMP | CONDITIONS | DESCRIPTION |
|--------------------------|------------------------------------|----------------|--|
| Blinking In Green | Off | Stand by mode | Projector is ready to be turned on. |
| Lighting In Green | Off | On mode | Projector is on and operating. |
| Lighting In Green | Blinking In Red (Slow) | Cool down mode | Projector is in cool down mode and will not respond to user input. |

In abnormal status~~~

| POWER | LAMP | CONDITIONS | DESCRIPTION |
|---------------------------------|------------------------------------|------------------|---|
| Blinking In Green | Blinking In Red (Fast) | Fan fault mode | The projector has detected a problem of a slow internal fan speed. The lamp will shut off automatically. Contact your dealer. |
| Blinking In Green | Lighting In Red | Lamp cover open | The lamp cover is open or there is a problem with the lamp. If the lamp door is closed and replacing the lamp does not correct the issue, contact your dealer. |
| Blinking In Green (Fast) | Blinking In Red (Fast) | High temperature | The projector has overheated and shut itself down. Correct the over temperature condition immediately. 1. Check that the ventilation slots are free from obstructions. 2. Check the cleanliness of the air filter. |
| Blinking In Green (Slow) | Blinking In Red (Slow) | Lamp fail | The lamp does not light. Come back to "stand by mode", and press the power button. |

Troubleshooting

Error For Machine Defects

The following problems may be confused with a machine defect. Check and follow the table. If it couldn't be improved, contact your dealer.

| Symptom | Cause / Remedy |
|-----------------------------------|--|
| Projector power does not turn on. | The power cord is disconnected. Plug the power cord into an AC outlet. |
| | Intending to turn on the projector again during the cool down mode. Wait until the cool down mode has completed. |
| | There is no lamp and/or lamp cover is not firmly closed. Please turn off the power and disconnect the power plug from the power outlet. Check if the lamp is installed or the lamp cover is firmly closed and turn on the power again. |
| | Power cord has impaired. When you touch the power cord, the indicator goes on then off, please remove the power cord and connect it again. If the situation is repeated, remove the power cord and contact your dealer. |
| No image | The input is not connected correctly. Select the appropriate input source. |
| | No signal input. Connect correctly. |
| | The lens cover is attached to the lens. Remove the lens cover. |
| Colors are pale | Color density and color matching are not adjusted correctly. Adjust the RGB setting. |
| | Color lose. Caused by poor VGA cable connection. |
| Abnormal brightness & contrast | Brightness and contrast are not adjusted correctly. Adjust the brightness and contrast setting. |
| | The lamp is near the end of its service life. Replace with a new lamp. |
| Video is blurred | The projection lens is not focused. Adjust the focus using the focus ring. |
| | The lens is dirty or misty. Clean the lens. |

Troubleshooting

Error For Machine Defects

| Symptom | Cause / Remedy |
|--------------------------------|--|
| No audio | The projector is not connected correctly. Check audio cable if connect correctly. |
| | The volume is set to minimum. Adjust the volume. |
| | Mute is turned on. Press the MUTE button. |
| Remote control is not working. | No battery. Before using the remote control, please check the battery of remote control. |
| | Remote signal is obstructed. Remove the obstacle between projector and remote control. |

Troubleshooting

List of Supported Monitor Displays

| Computer mode | | |
|----------------------------|--------------------------|--------------------------|
| Signal | Refresh Rate (Hz) | Resolution (dots) |
| VGA | 60 | 640x480 |
| VESA | 60/72/75/85 | 640x480 |
| SVGA | 56/60/72/75/85 | 800x600 |
| XGA | 60/70/75/85 | 1024x768 |
| SXGA | 70/75 | 1152x864 |
| SXGA | 60/75 | 1280x960 |
| SXGA | 60 | 1280x1024 |
| WXGA | 60/75 | 1280x800 |
| WXGA+ | 60/75/85 | 1440x900 |
| SXGA + | 60/75 | 1400x1050 |
| UXGA | 60 | 1600x1200 |
| WSXGA+ | 60 | 1680x1050 |
| MAC | 67 | 1280x1024 / 640x480 |
| MAC | 75 | 832x624 |
| MAC | 75 | 1024x768 |
| MAC | 75 | 1152x870 |
| Component (Y,Pb,Pr) | | |
| Signal | Refresh Rate (Hz) | Resolution (dots) |
| SDTV(480i) | 30 | 720x480 |
| SDTV(480p) | 60 | 720x480 |
| HDTV(720p) | 60 | 1280x720 |
| HDTV(1080i) | 30 | 1920x1080 |
| Composite / S-Video | | |
| Signal | Refresh Rate (Hz) | Resolution (dots) |
| TV(NTSC) | 60 | 720x480 |
| TV(PAL,SECAM) | 50 | 720x576 |

Appendix

Menu Tree (PC Mode)

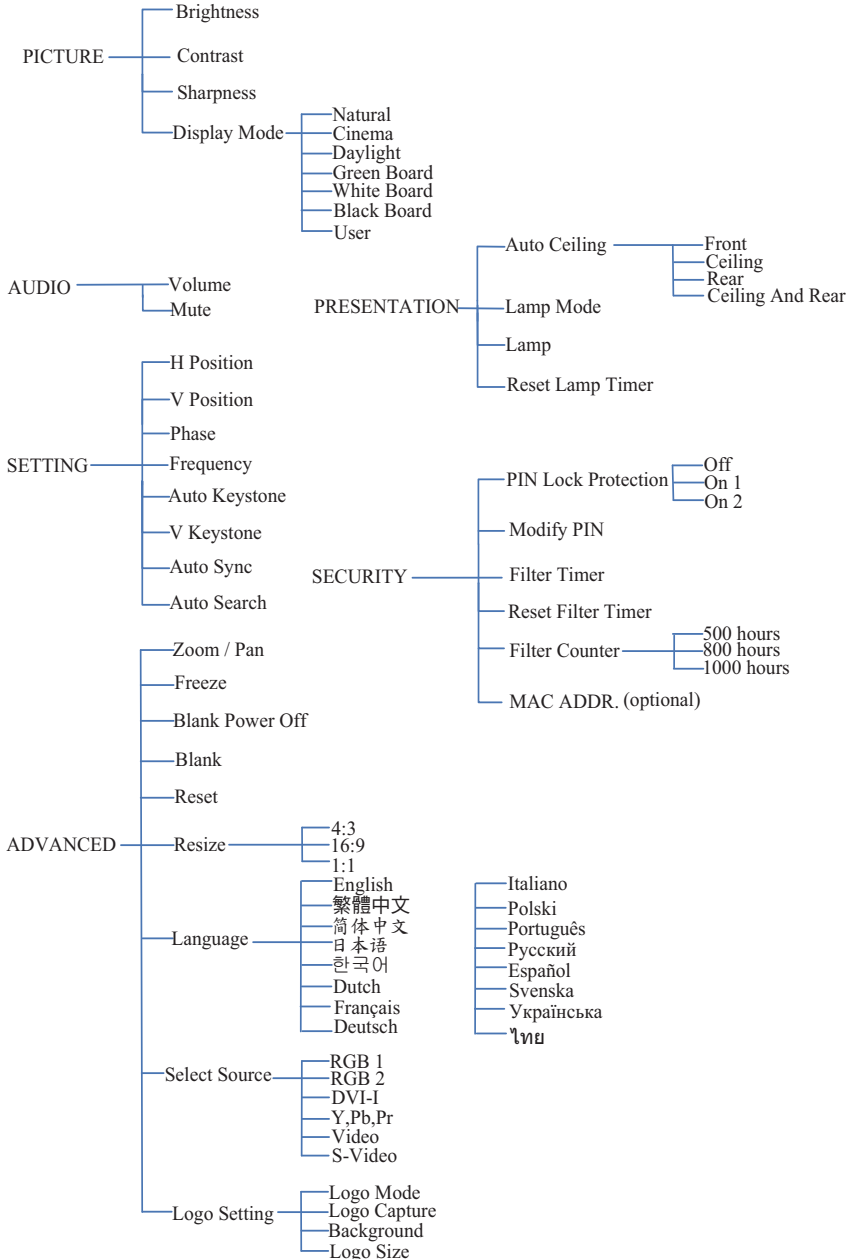

*DVI doesn't support H / V POSITION, PHASE, FREQUENCY, AUTO SYNC function.

Appendix

Menu Tree (Video Mode)

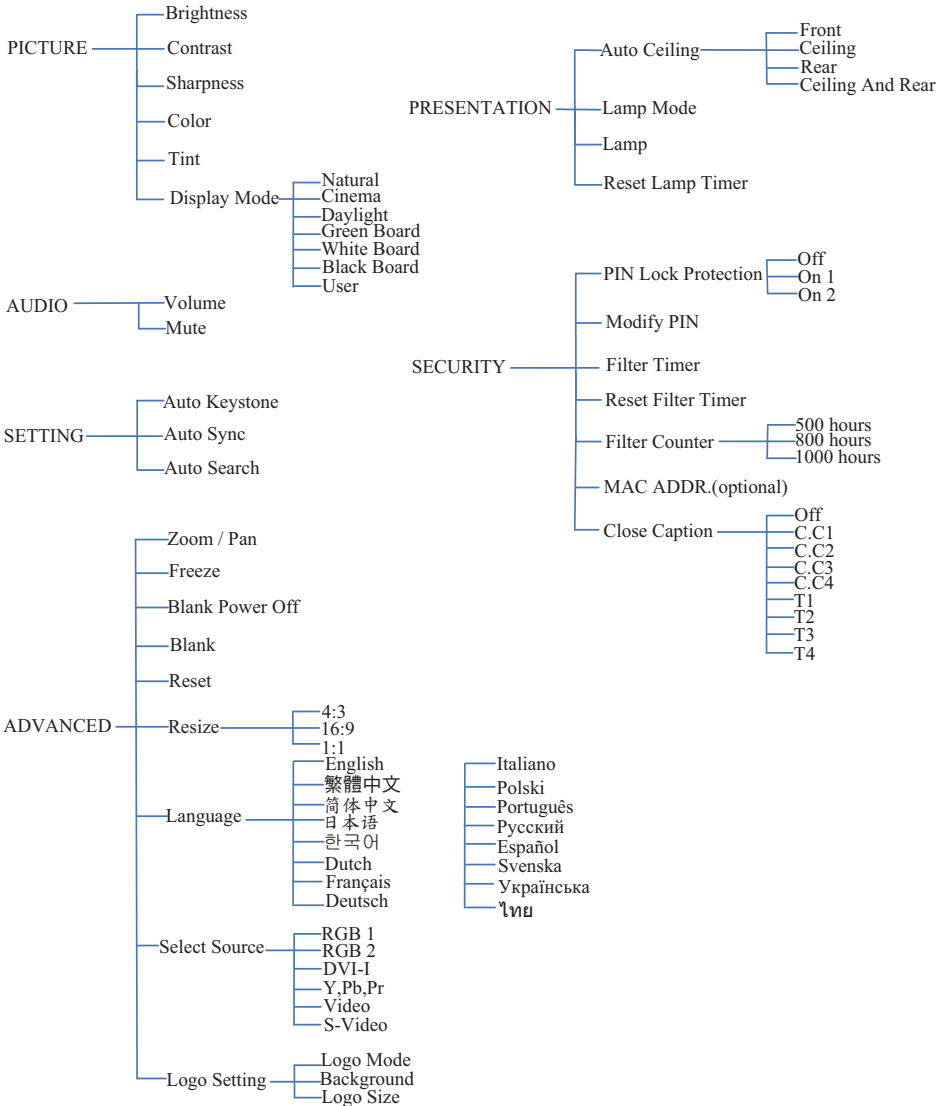

Appendix

Appearance

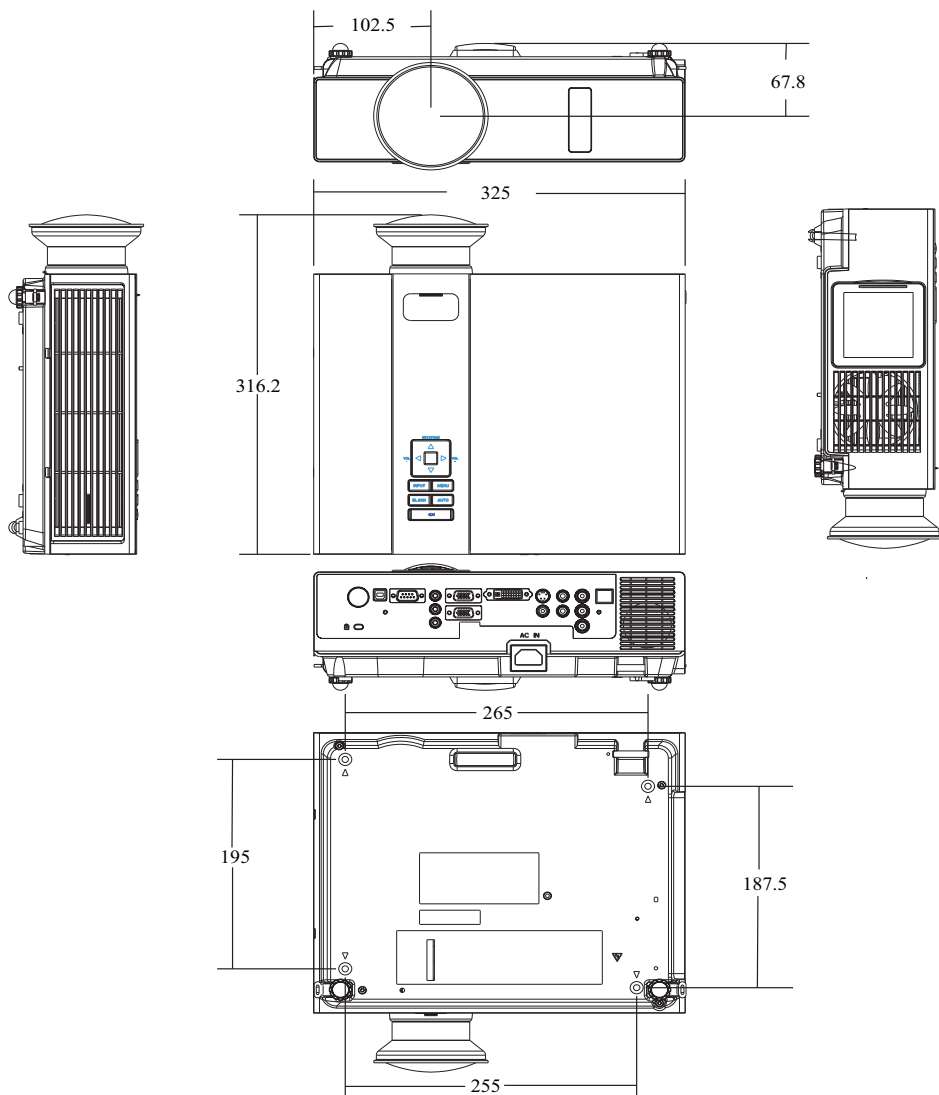

Projector

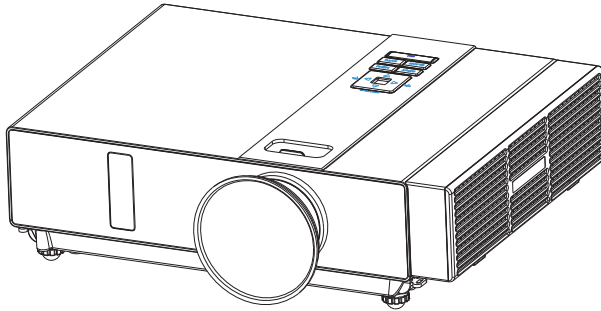

About the Owner's Manual

Please read the owner's manual thoroughly to ensure correct usage of the projector and its features.

After reading, store the owner's manual in a safe place for future reference.

Features

1. Dress up Design
2. Designed for tough environment
3. Side change lamp
4. Side change filter
5. Quick off
6. Advanced Anti-theft features
7. Five auto features (Auto Search, Auto Sync, Auto Ceiling, Auto Keystone and Auto Filter Alert)
8. Seven display modes (Natural, Cinema, Daylight, Green board, White Board, Black Board and User)
9. Built-in 8W speaker
10. Logo capture
11. Image freeze function
12. Digital zoom adjustment
13. Extreme Short Throw Distance.

The content of this manual is subject to change without previous notice.

All rights reserved.

Issue of edition 1002.05_01

Contents of Your Box

Check-list of your accessories

Please make sure that following items are included in the box, along with the main. If any items missing, contact your dealer.

1. Projector

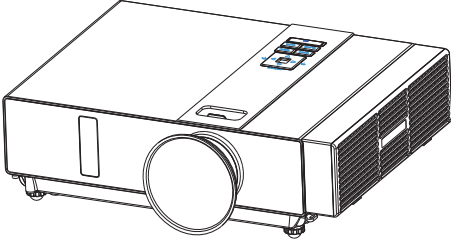

2. Computer cable

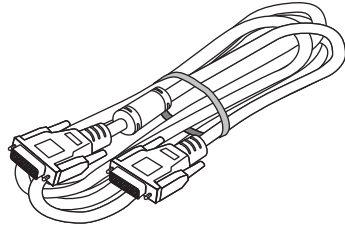

3. Power cord

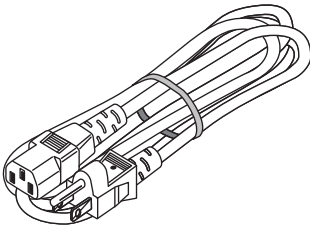

4. Quick Start Guide

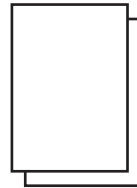

5. Owner's Manual CD

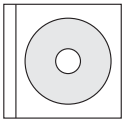

6. Convergence Lens



7. Remote control

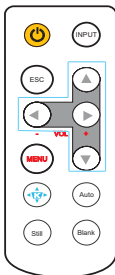

Safety Labels

Safety labels are used on or within the projector to alert you to items or areas requiring your attention.

WARNING LABEL

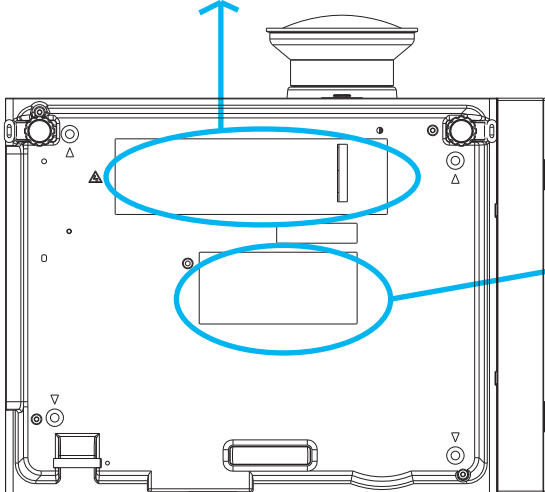

EMI LABEL



LAMP DOOR WARNING LABEL

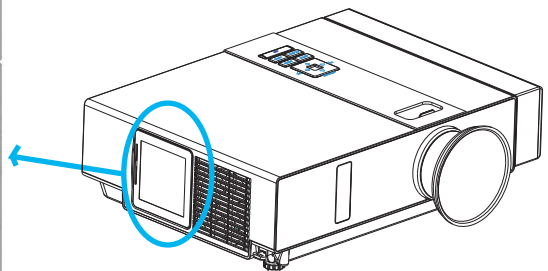

Projector

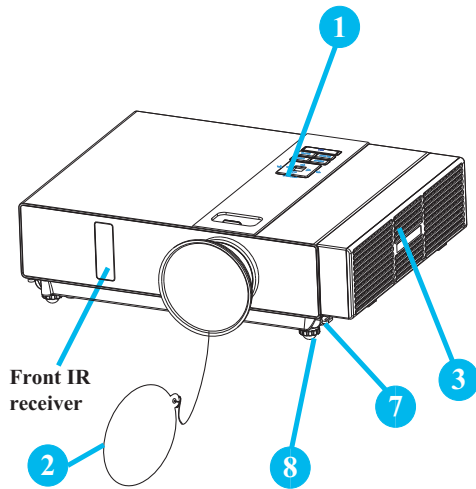

Front IR receiver

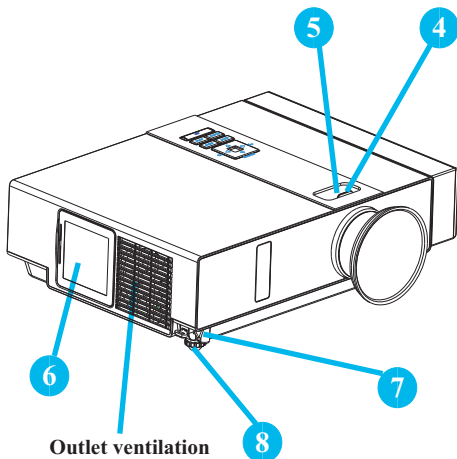

Outlet ventilation

1 Control panel

Operating system.

2 Lens cover

Attach when not using to protect the lens from becoming dirty or damaged.

3 Filter cover

Prevents dust and other foreign particles from being drawn into projector.

Remove the filter cover to clean the air filter.

4 Focus ring

Use the focus ring to focus the projector image.

Rotate the focus ring until the image is clear.

5 Zoom ring

Use the zoom ring to adjust the size of the projected image.

Rotate the zoom ring until the image is the desired size.

6 Lamp door

The lamp unit is inside.

7 Foot adjust button

Lock / unlock the adjustable foot.

8 Front adjustable foot

Extend and retract to adjust the projection angle.

Rear

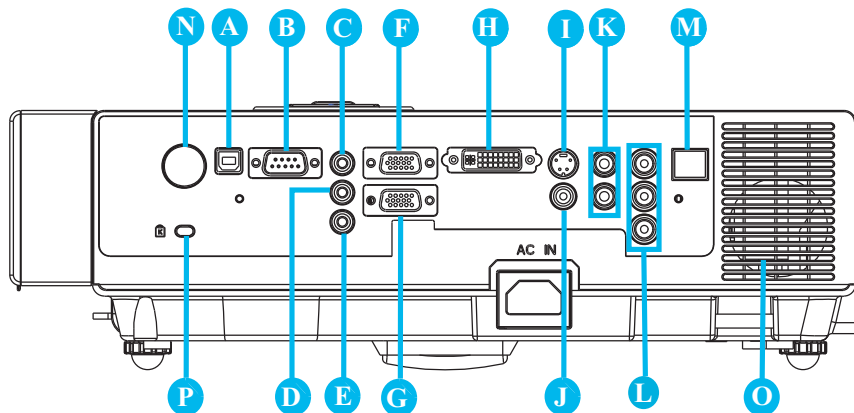

A MOUSE

Connect a USB mouse cable to a computer to control computer mouse functions.

B RS232

Serial data port for controlling the projector with a computer or other RS-232 control device.

C AUDIO IN 1 & D AUDIO IN 2

Mini jack port corresponds to computer input.(RGB IN→AUDIO IN 1, DVI-1 IN →AUDIO IN 2)

E AUDIO OUT

This jack outputs the audio signal from computer signal to external audio equipment.

F RGB IN

Input analog RGB video signal from a computer.

G RGB OUT

Connect an external monitor to this connection to view the "RGB IN" input.

H DVI-I IN

Input digital DVI-I signal from a computer.

I S-VIDEO

S-Video signal from a video source.

J VIDEO

Composite video signal from a video source.

K AUDIO IN 3, R / L

RCA type corresponds to video input.

L COMPONENT /Y, Pb, Pr

Input Y,Pb,Pr signal from a DVD player.

M LAN (Optional)

This function is optional.

Please see page 34 Network Control Application for details.

N REAR IR RECEIVER

O SPEAKER

P Slot for Kensington Micro Saver

Security System

Built-in Security Slot

This security slot supports the MicroSaver[®] Security System. MicroSaver[®] is a registered trademark of Kensington Microware Inc.

The logo is trademarked and owned by Kensington Microware Inc.

Part Names

Power ON / OFF

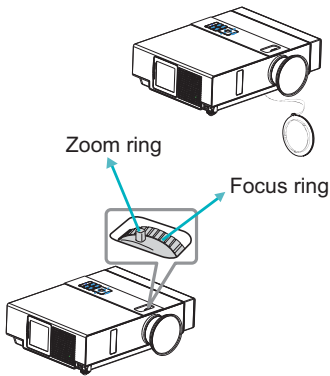
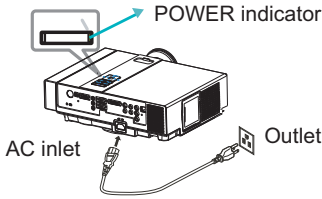

Power off?

Please press

POWER
key again to power off.

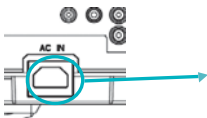
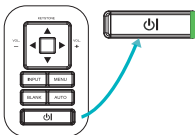

Turning on the power

1. Make sure that power cord is firmly and correctly connected to the projector.
2. Remove the lens cover, and the POWER indicator will light up in green.
3. Press POWER button on the control panel or the remote control to turn on the projector.
4. Rotate the zoom ring to adjust the screen size.
5. Rotate the focus ring to adjust the focus.

WARNING

- ★ A strong light is emitted when the projector's power is on. Do not look into the lens of the projector or look inside of the projector through any of the projector's openings.

Turning off the power

1. Press the POWER button on the control panel or the remote control. The "power off" confirmation message appears.
2. Press the POWER button again while the message appears.
3. When the projector enters "standby" mode, the POWER indicator will light up in green.
4. If you don't use the projector, remove power cord.

WARNING

- ★ Do not touch around the lamp cover and the exhaust vents during use or just after use, since it is too hot.

CAUTION

- ★ Do not turn off the AC power for 60 seconds after the lamp is turned on. Doing so could cause premature lamp failure.

Setting Up

Ceiling Mounted Installation Guide

Attach ceiling mount at four-suspension bracket fixing points when suspending from a ceiling. Special installation is required in order to suspend the projector from the ceiling. Please ask your dealer for details.

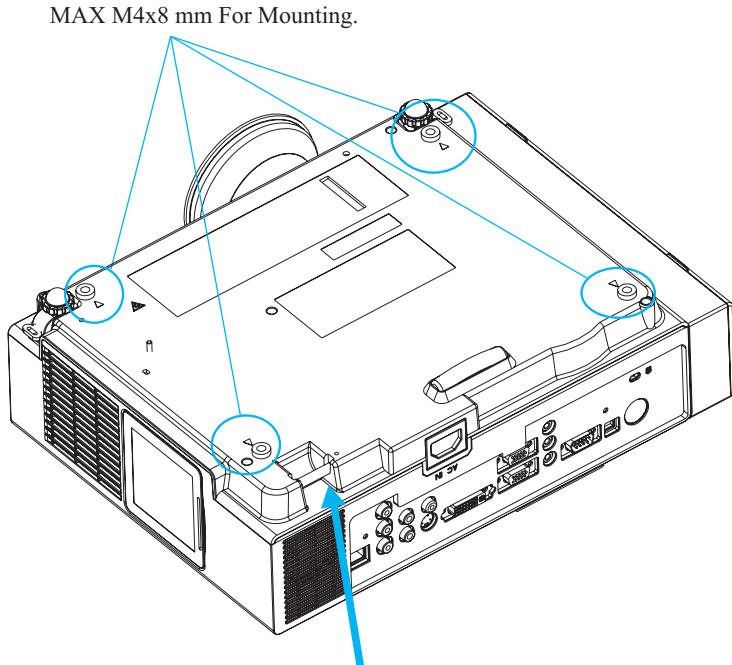

Security Anchor

The product is equipped with security anchor and PIN LOCK functions to help prevent unauthorized removal projector.

WARNING

- ▶ Do not grasp the security anchor to carry projector, since it is not designed for it.
- ▶ The security anchor is not for comprehensive theft prevention measures. It is intended to be used as supplemental theft prevention measure.

Adjusting The Projector's Elevation

Use the adjustable foot at the front of the projector to set the image height.

- 1 Holding the projector, push the foot adjust buttons to loosen the front adjustable foot.
- 2 Position the front side of the projector to the desired height.
- 3 Release the foot adjust buttons in order to lock the front adjustable feet.
- 4 After making sure that the front adjustable feet are locked, put the projector gently atop.

CAUTION

- * The adjustment range of front adjustable foot is 0 to 8.5 degrees.
- * When the foot is adjusted, it may cause the shape of the projected image to become distorted. Use the keystone correction function to correct this distortion.

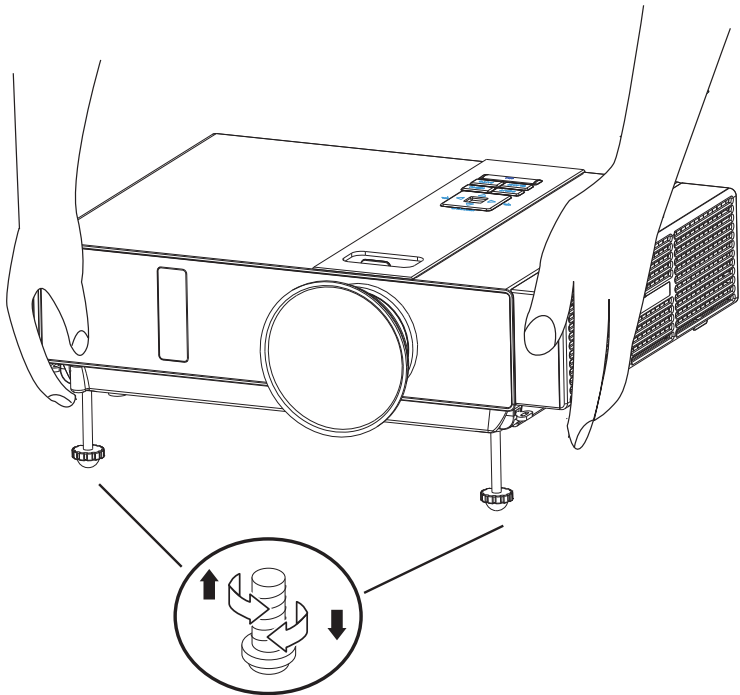

How To Connect

Laptop or desktop computer

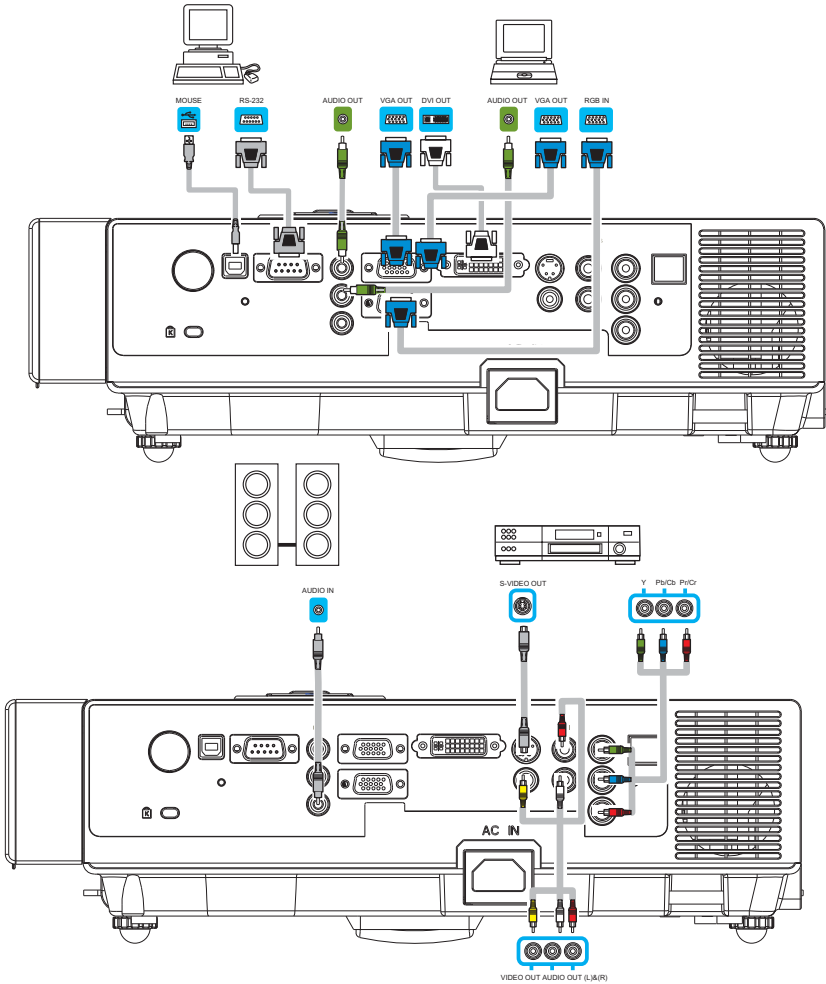

Before starting, make sure that the projector and computer are both turned off.

Connect the computer cable

Connect the computer cable from the computer to the projector's RGB IN or DVI-I IN. If needed, connect the MONITOR OUT to a monitor to view input from RGB IN or DVI-I IN. Tighten the screw on all connectors.

Network Control Software Application

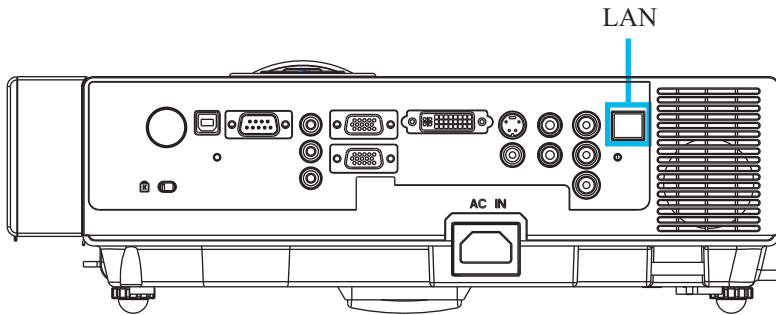

NOTE: This Network Control Software Application is an optional function and support model with RJ45 LAN port only.

- ❶ Register the projector(s) which needs to be controlled.
"Auto search" can help you to seek the projector(s) source easily.
After registering in the work group, you can start to control the projector.
- ❷ Group the projector(s) into different sections.
You can monitor the status easily by the sort of group name function in the network.
- ❸ Monitor the status for each projector.
 - a. You can manage and change the monitoring content by System Parameter Setting.
 - b. The Lamp timer, filter working time or system warning feedback etc. can be known by checking the status for projector(s).
- ❹ Control the booked projector(s).
The status can be refreshed and acquired by monitoring functions; you can also operate the function easily by Network Control.

NOTE

To monitor and control the projector(including stand-by mode), the following conditions need to be ready:

- (1) Projector should already be powered on.
- (2) Projector is connected to network.
- (3) LED light of the projector network port shows normal. (Green light on, Orange twinkle)

* Stand-by mode indicator: Green LED (Power) on the projector's control panel flashes.

Maintenance of Projector

Air Filter

When a warning message appears to remind you to clean the air filter, please replace a new one as soon as possible. Please check and clean the air filter periodically.

Replacing the Air Filter

When the use time reaches the filter counter time, the projector will display a message that indicates to replace a new filter. If there is no spare air filter available, please contact your dealer.

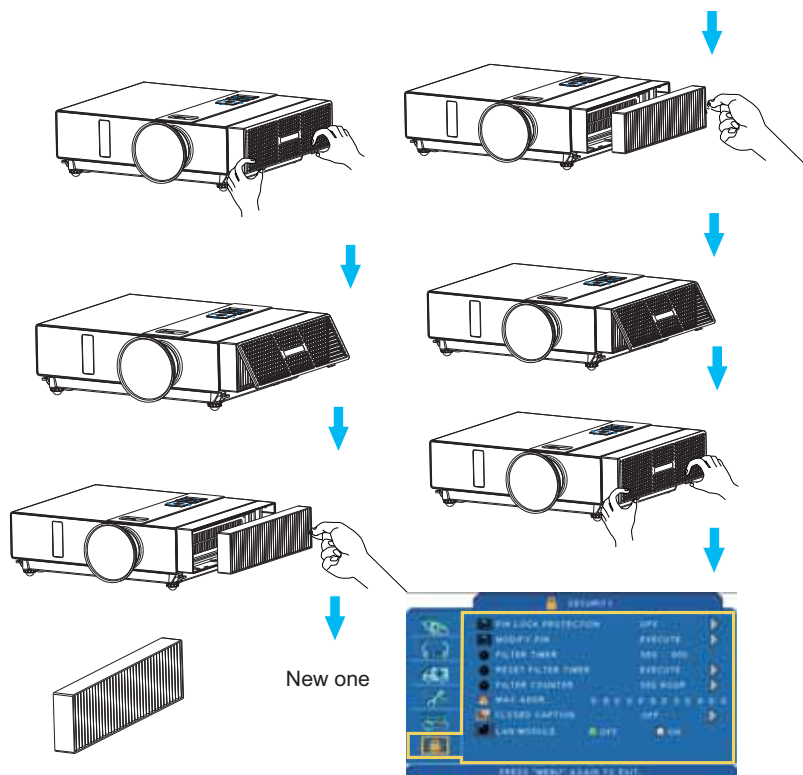

Turn off the projector, and unplug the power cord. Allow the projector to sufficiently cool down.

- 1 Remove the filter cover from the right side of projector.
- 2 Pull out the air filter.
- 3 Install a new air filter.
- 4 Put the filter cover on.
- 5 Reset filter timer after cleaning or changing air filter. (P.35)

Maintenance of Projector

Lamp

1. If you want to replace new lamp, but the projector was just turned off, please let the projector cool down and unplug power cord at least 60 minutes.
2. If the projector is mounted in the ceiling, contact your dealer to replace the lamp.

Replacing New Lamp

1. Remove the lamp door.
2. Loosen 2 screws of the lamp holder. Take the handle on the top of the lamp, pull out the lamp straight off the projector.
3. Insert new lamp, lock the lamp door firmly with 2 screws.
4. Put the lamp door on.
5. Please reset the lamp timer after replacing lamp. (P.34)

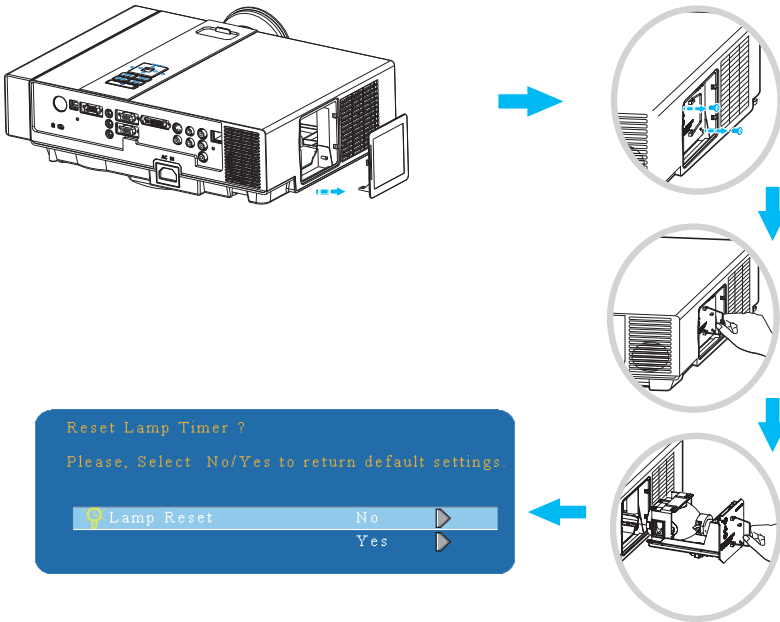

Appendix

Appearance

