

Panasonic®

Operating Instructions Projector Operations

LCD Projector Commercial Use

Model No. **PT-FW430U**
PT-FX400U

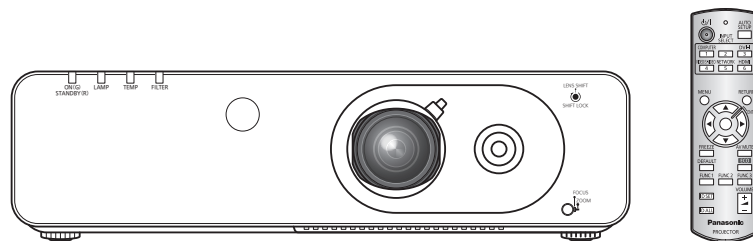

Thank you for purchasing a Panasonic Projector.

■ Before operating this product, please read the instructions carefully and save this manual for future use.

For information on using the product via a network, refer to “Operating Instructions – Network Operations”.

ENGLISH

TQBJ0386-1

Read this first!

WARNING: TO REDUCE THE RISK OF FIRE OR ELECTRIC SHOCK, DONOT EXPOSE THIS PRODUCT TO RAIN OR MOISTURE.

Power Supply: This Projector is designed to operate on 100 V - 240 V, 50 Hz/60 Hz AC, house current only.

CAUTION: The AC power cord which is supplied with the projector as an accessory can only be used for power supplies up to 125 V, 7 A. If you need to use higher voltages or currents than this, you will need to obtain a separate 250 V power cord. If you use the accessory cord in such situations, fire may result.



The lightning flash with arrowhead symbol, within an equilateral triangle, is intended to alert the user to the presence of uninsulated “dangerous voltage” within the product’s enclosure that may be of sufficient magnitude to constitute a risk of electric shock to persons.



The exclamation point within an equilateral triangle is intended to alert the user to the presence of important operating and maintenance (servicing) instructions in the literature accompanying the product.

CAUTION: This equipment is equipped with a three-pin grounding-type power plug. Do not remove the grounding pin on the power plug. This plug will only fit a grounding-type power outlet. This is a safety feature. If you are unable to insert the plug into the outlet, contact an electrician. Do not defeat the purpose of the grounding plug.

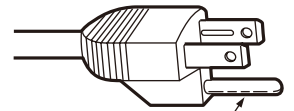

Do not remove

FCC NOTICE (USA)

Declaration of Conformity

Model Number: PT-FW430U/PT-FX400U
 Trade Name: Panasonic
 Responsible Party: Panasonic Corporation of North America
 Address: One Panasonic Way, Secaucus, NJ 07094
 Telephone number: (877)803-8492
 E-mail: projectorsupport@us.panasonic.com

This device complies with Part 15 of the FCC Rules.

Operation is subject to the following two conditions:

(1) This device may not cause harmful interference, and (2) this device must accept any interference received, including interference that may cause undesired operation.

To assure continued compliance, follow the attached installation instructions and do not make any unauthorized modifications.

CAUTION:

This equipment has been tested and found to comply with the limits for a Class B digital device, pursuant to Part 15 of the FCC Rules. These limits are designed to provide reasonable protection against harmful interference in a residential installation. This equipment generates, uses and can radiate radio frequency energy and, if not installed and used in accordance with the instructions, may cause harmful interference to radio communications. However, there is no guarantee that interference will not occur in a particular installation. If this equipment does cause harmful interference to radio or television reception, which can be determined by turning the equipment off and on, the user is encouraged to try to correct the interference by one of the following measures:

- Reorient or relocate the receiving antenna.
 - Increase the separation between the equipment and receiver.
 - Connect the equipment into an outlet on a circuit different from that to which the receiver is connected.
 - Consult the dealer or an experienced radio/TV technician for help.
- The user may find the booklet "Something About Interference" available from FCC local regional offices helpful.

FCC Warning:

To assure continued FCC emission limit compliance, follow the attached installation instructions and the user must use only shielded interface cables when connecting to host computer or peripheral devices. Also, any unauthorized changes or modifications to this equipment could void the user's authority to operate this device.

NOTIFICATION (Canada)

This class B digital apparatus complies with Canadian ICES-003.

WARNING:

- Not for use in a computer room as defined in the Standard for the Protection of Electronic Computer/Data Processing Equipment, ANSI/NFPA 75.
- For permanently connected equipment, a readily accessible disconnect device shall be incorporated in the building installation wiring.
- For pluggable equipment, the socket-outlet shall be installed near the equipment and shall be easily accessible.

NOTICE U.S.A. only:

- This product has a High Intensity Discharge (HID) lamp that contains mercury. Dispose may be regulated in your community due to environmental considerations. For disposal or recycling information, please visit Panasonic website: <http://www.panasonic.com/environmental> or call 1-888-769-0149.

For USA-California Only

This product contains a CR Coin Cell Lithium Battery which contains Perchlorate Material – special handling may apply.
 See www.dtsc.ca.gov/hazardouswaste/perchlorate.

Read this first!

WARNING:

■ POWER

The wall outlet or the circuit breaker shall be installed near the equipment and shall be easily accessible when problems occur. If the following problems occur, cut off the power supply immediately.

Continued use of the projector in these conditions will result in fire or electric shock.

- If foreign objects or water get inside the projector, cut off the power supply.
- If the projector is dropped or the cabinet is broken, cut off the power supply.
- If you notice smoke, strange smells or noise coming from the projector, cut off the power supply.

Please contact an Authorized Service Center for repairs, and do not attempt to repair the projector yourself.

During a thunderstorm, do not touch the projector or the cable.

Electric shocks can result.

Do not do anything that might damage the power cord or the power plug.

If the power cord is used while damaged, electric shocks, short-circuits or fire will result.

- Do not damage the power cord, make any modifications to it, place it near any hot objects, bend it excessively, twist it, pull it, place heavy objects on top of it or wrap it into a bundle.

Ask an Authorized Service Center to carry out any repairs to the power cord that might be necessary.

Insert the power plug securely into the wall outlet.

If the plug is not inserted correctly, electric shocks or overheating will result.

- Do not use anything other than the provided power cord.
- Do not use the provided power cord for other electrical equipment.
- Do not use plugs which are damaged or wall outlets which are coming loose from the wall.

Clean the power plug regularly to prevent it from becoming covered in dust.

Failure to observe this will cause a fire.

- If dust builds up on the power plug, the resulting humidity can damage the insulation.
- If not using the projector for an extended period of time, pull the power plug out from the wall outlet.

Pull the power plug out from the wall outlet and wipe it with a dry cloth regularly.

Do not handle the power plug with wet hands.

Failure to observe this will result in electric shocks.

Do not overload the wall outlet.

If the power supply is overloaded (ex., by using too many adapters), overheating may occur and fire will result.

■ ON USE/INSTALLATION

Do not place liquid containers on top of the projector.

If water spills onto the projector or gets inside it, fire or electric shocks will result.

If any water gets inside the projector, contact an Authorized Service Center.

Do not place the projector on soft materials such as carpets or sponge mats.

Doing so will cause the projector to overheat, which can cause burns, fire or damage to the projector.

Do not set up the projector in humid or dusty places or in places where the projector may come into contact with oily smoke or steam, ex. a bathroom.

Using the projector under such conditions will result in fire, electric shocks or components deterioration.

Components deterioration (such as ceiling mount brackets) may cause the projector which is mounted on the ceiling to fall down.

Do not install this projector in a place which is not strong enough to take the full weight of the projector or on top of a surface which is sloped or unstable.

Failure to observe this will cause projector to fall down or tip over the projector, and severe injury or damage could result.

Do not place another projector or other heavy objects on top of the projector.

Failure to observe this will cause the projector to become unbalanced and fall, which could result in damage or injury. The projector will be damaged or deformed.

WARNING:**Installation work (such as ceiling mount bracket) should only be carried out by a qualified technician.**

If installation is not carried out and secured correctly it can cause injury or accidents, such as electric shocks.

- Do not use anything other than an authorized ceiling mount bracket.
- Be sure to use the provided accessory wire with an eye bolt as an extra safety measure to prevent the projector from falling down. (Install in a different location to the ceiling mount bracket)

Do not cover the air inlet port or the air outlet port.

Doing so will cause the projector to overheat, which can cause fire or damage to the projector.

- Do not place the projector in narrow, badly ventilated places such as closets or bookshelves.
- Do not place the projector on cloth or papers, as these materials could be drawn into the air inlet port.

Do not place your hands or other objects close to the air outlet port.

Doing so will cause burns or damage your hands or other objects.

- Heated air comes out of the air outlet port. Do not place your hands or face, or objects which cannot withstand heat close to this port.

Do not look and place your skin into the lights emitted from the lens while the projector is being used.

Doing so can cause burns or loss of sight.

- Strong light is emitted from the projector's lens. Do not look or place your hands directly into this light.
- Be especially careful not to let young children look into the lens. In addition, turn off the power and disconnect the power plug when you are away from the projector.

Do not insert any foreign objects into the projector.

Doing so will cause fire or electric shocks.

- Do not insert any metal objects or flammable objects into the projector or drop them onto the projector.

Never attempt to remodel or disassemble the projector.

High voltages can cause fire or electric shocks.

- For any inspection, adjustment and repair work, please contact an Authorized Service Center.

Do not project an image with the lens cover attached.

Doing so can cause fire.

Do not allow metal objects, flammable objects, or liquids to enter inside of the projector. Do not allow the projector to get wet.

Doing so may cause short circuits or overheating, and result in fire, electric shock, or malfunction of the projector.

- Do not place containers of liquid or metal objects near the projector.
- If liquid enters inside of the projector, consult your dealer.
- Particular attention must be paid to children.

Use the ceiling mount bracket specified by Panasonic.

Defects in the ceiling mount bracket will result in falling accidents.

- Attach the supplied safety cable to the ceiling mount bracket to prevent the projector from falling down.

Be sure to ask authorized personnel or your supplier when mounting the product to a ceiling.

This requires an optional ceiling mount bracket.

Model No.: ET-PKF110H (for high ceilings), ET-PKF110S (for low ceilings)

- Be sure to consult your dealer when using the ceiling mount bracket for the PT-F300U/PT-FW300U (ET-PKF100H for high ceilings or ET-PKF100S for low ceilings).

Read this first!

WARNING:

■ ACCESSORIES

Do not use or handle the batteries improperly, and refer to the following.

Failure to observe this will cause burns, batteries to leak, overheat, explode or catch fire.

- Do not use unspecified batteries.
- Do not disassemble dry cell batteries.
- Do not heat the batteries or place them into water or fire.
- Do not allow the + and – terminals of the batteries to come into contact with metallic objects such as necklaces or hairpins.
- Do not store batteries together with metallic objects.
- Store the batteries in a plastic bag and keep them away from metallic objects.
- Make sure the polarities (+ and –) are correct when inserting the batteries.
- Do not use a new battery together with an old battery or mix different types of batteries.
- Do not use batteries with the outer cover peeling away or removed.
- Remove the empty batteries from the remote control at once.
- Insulate the battery using tape or something similar before disposal.

Do not allow children to reach the batteries (AA/R6/LR6 type).

- The battery can cause personal injury if swallowed.
- If swallowed, seek medical advice immediately.

If the battery fluid leaks, do not touch it with bare hands, and take the following measures if necessary.

- Battery fluid on your skin or clothing could result in skin inflammation or injury.
Rinse with clean water and seek medical advice immediately.
- Battery fluid coming in contact with your eyes could result in loss of sight.
In this case, do not rub your eyes. Rinse with clean water and seek medical advice immediately.

Do not disassemble the lamp unit.

If the lamp breaks, it could cause injury.

Lamp replacement

The lamp has high internal pressure. If improperly handled, an explosion and severe injury or accidents will result.

- The lamp can easily explode if struck against hard objects or dropped.
- Before replacing the lamp, be sure to disconnect the power plug from the wall outlet.
Electric shocks or explosions can result if this is not done.
- When replacing the lamp, turn the power off and allow the lamp to cool for at least one hour before handling it otherwise it can cause burns.

Do not allow infants or pets to touch the remote control unit.

- Keep the remote control unit out of the reach of infants and pets after using it.

Do not use the supplied power cord with devices other than this projector.

- Using the supplied power cord with devices other than this projector may cause short circuits or overheating, and result in electric shock or fire.

Remove the depleted batteries from the remote control promptly.

- Leaving them in the unit may result in fluid leakage, overheating, or explosion of the batteries.

CAUTION:**■ POWER**

When disconnecting the power cord, be sure to hold the power plug and power connector.

If the power cord itself is pulled, the lead will become damaged, and fire, short-circuits or serious electric shocks will result.

When not using the projector for an extended period of time, disconnect the power plug from the wall outlet and remove the batteries from the remote control.

Disconnect the power plug from the wall outlet before carrying out any cleaning and replacing the unit. Electric shocks can result if this is not done.

■ ON USE/INSTALLATION

Do not put your weight on this projector.

You could fall or the projector could break, and injury will result.

- Be especially careful not to let young children stand or sit on the projector.

Do not place the projector in extremely hot locations.

Doing so will cause the outer casing or internal components to deteriorate, or result in fire.

- Take particular care in locations exposed to direct sunlight or near stoves.

Always disconnect all cables before moving the projector.

Moving the projector with cables still attached can damage the cables, which will cause fire or electric shocks to occur.

■ ACCESSORIES

Do not use the old lamp unit.

If used it could cause lamp explosion.

If the lamp has broken, ventilate the room immediately. Do not touch or bring your face close to the broken pieces.

Failure to observe this will cause the user to absorb the gas which was released when the lamp broke and which contains nearly the same amount of mercury as fluorescent lamps, and the broken pieces will cause injury.

- If you believe that you have absorbed the gas or that the gas has got into your eyes or mouth, seek medical advice immediately.
- Ask your dealer about replacing the lamp unit and check the inside of the projector.

Do not attach the air filter unit while it is wet.

Doing so may result in electric shock or malfunctions.

- After you clean the air filter units, dry them thoroughly before reattaching them.

Brazil Only Brasil Apenas

■ Manuseio de baterias usadas



BRASIL

Após o uso, as pilhas e /ou baterias poderão ser entregues ao estabelecimento comercial ou rede de assistência técnica autorizada.

Cobrir os terminais positivo (+) e negativo (-) com uma fita isolante adesiva, antes de depositar numa caixa destinada para o recolhimento. O contato entre partes metálicas pode causar vazamentos, gerar calor, romper a blindagem e produzir fogo.

Não desmonte, não remova o invólucro, nem amasse a bateria. O gás liberado pela bateria pode irritar a garganta, danificar o lacre do invólucro ou o vazamento provocar calor, ruptura da blindagem e produzir fogo devido ao curto circuito dos terminais.

Não incinere nem aqueça as baterias, elas não podem ficar expostas a temperaturas superiores a 100 °C (212 °F). O gás liberado pela bateria pode irritar a garganta, danificar o lacre do invólucro ou o vazamento provocar calor, ruptura da blindagem e produzir fogo devido ao curto circuito dos terminais provocado internamente.

Evite o contato com o líquido que vazar das baterias. Caso isto ocorra, lave bem a parte afetada com bastante água. Caso haja irritação, consulte um médico.

■ Remoção das baterias

1. Pressione a guia e levante a tampa.

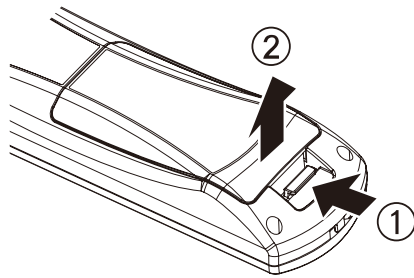

2. Remova as baterias.

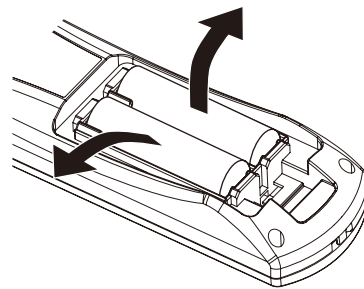

Trademarks

- HDMI, the HDMI logo and High-Definition Multimedia Interface is a trademark or registered trademark of HDMI Licensing LLC.
 - Other names, company names or product names used in these operating instructions are the trademarks or registered trademarks of their respective holders.
- Please note that the operating instructions do not include the ® and TM symbols.

Illustrations in these operating instructions

- Note that illustrations of the projector and screens may differ from the ones you actually see.

Page references

- In these instructions, references to pages are indicated as: (➡ page 00).

Term

- In these instructions, the “Wireless remote control unit” accessory is referred to as the “Remote control”.

Easy setup and improved serviceability

- ▶ The 2x zoom lens and the lens shift allow more flexible setup of the projector.

Improved color reproducibility and fine display

- ▶ The lamp boost function and the image enhancer with the original system are installed to improve color reproducibility and fine display.

Improved connectivity

- ▶ The inclusion of an HDMI terminal provides support for high quality video and HDMI audio.
- ▶ An optional Wireless Module can be added for wireless LAN connectivity.

Quick steps

For details, see the corresponding pages.

1. **Set up your projector.**
(⇒ page 21)



2. **Connect with other devices.**
(⇒ page 27)



3. **Connect the power cord.**
(⇒ page 28)



4. **Power on.**
(⇒ page 29)



5. **Set the initial settings.*1**
(⇒ page 16)



6. **Select the input signal.**
(⇒ page 31)



7. **Adjust the image.**
(⇒ page 31)

*1 : This is the step to be taken when you turn the power on for the first time after purchase.

Contents

Be sure to read "Read this first!". (→ pages 2 to 8)

Important Information

Read this first!	2
Precautions for Use	12
Cautions when transporting	12
Cautions when installing	12
Security	13
Disposal	13
Cautions on use	14
Accessories.....	15
Optional accessories.....	15

Preparation

Start-up display	16
About Your Projector	17
Remote control.....	17
Projector body.....	18
CONTROL PANEL	19
Rear terminals.....	19
Using Remote control	20
Installing and removing batteries	20
Setting Remote control ID numbers.....	20

Getting Started

Setting up	21
Projection method	21
Parts for ceiling mount (Optional)	21
Screen size and throw distance	22
Adjusting front adjustable feet.....	24
Adjusting the position using the lens shift function.....	24
Connections	27
Before connecting to the projector.....	27
Connecting example	27

Basic Operation

Powering ON/OFF	28
Connecting the power cord	28
Power indicator	28

Powering up the projector	29
Making adjustment and selection.....	29
Powering off the projector	30
Direct power off function	30

Projecting	31
Selecting the image	31
How to adjust the state of the image.....	31

Basic operations using the remote control	32
Using the AV MUTE function.....	32
Using the FREEZE function	32
Switching the input signal	32
Adjusting the display position automatically.....	33
Using the function buttons	33
Using ECO button	33
Resetting to the factory default	33
Controlling the volume of the speaker	34

Settings

Menu Navigation	35
Navigating through the menu.....	35
MAIN MENU	36
SUB MENU	36
PICTURE menu	38
PICTURE MODE	38
CONTRAST	38
BRIGHTNESS.....	38
COLOR	39
TINT	39
SHARPNESS.....	39
COLOR TEMPERATURE	39
ADVANCED MENU.....	40
DAYLIGHT VIEW	40
DIGITAL CINEMA REALITY.....	40
NOISE REDUCTION	41
TV-SYSTEM.....	41
RGB/YP _B Pr.....	41
POSITION menu	42
KEystone	42
SHIFT.....	42

Contents

SHIFT V	42	TEXT CHANGE	65
DOT CLOCK	43	MENU LOCK.....	65
CLOCK PHASE	43	MENU LOCK PASSWORD.....	65
OVER SCAN.....	43	CONTROL DEVICE SETUP	66
ASPECT.....	44	NETWORK.....	67
FRAME LOCK.....	47		
LANGUAGE.....	48		
Changing the display language.....	48		
DISPLAY OPTION menu	49		
ON-SCREEN DISPLAY	49		
DVI-I IN	50		
HDMI IN	50		
CLOSED CAPTION SETTING.....	51		
SCREEN SETTING	51		
STARTUP LOGO	52		
AUTO SETUP	52		
SIGNAL SEARCH.....	53		
BACK COLOR	53		
WIDE MODE.....	53		
SXGA MODE	53		
OTHER FUNCTIONS	54		
PROJECTOR SETUP menu.....	56		
STATUS	56		
PROJECTOR ID	56		
INITIAL START UP.....	56		
PROJECTION METHOD	57		
HIGH ALTITUDE MODE	57		
LAMP POWER.....	57		
SCHEDULE	58		
ECO MANAGEMENT	59		
EMULATE	60		
FUNCTION BUTTON.....	60		
AUDIO SETTING	61		
DATE AND TIME.....	62		
TEST PATTERN.....	63		
INITIALIZE ALL.....	63		
SECURITY menu.....	64		
PASSWORD	64		
PASSWORD CHANGE.....	64		
DISPLAY SETTING	65		

Maintenance

LAMP, TEMP and FILTER Indicators 68

Managing the indicated problems68

Replacement 70

Before replacing the unit.....70

Maintenance

Replacing the unit.....71

Cautions on Wireless Module Installation..... 74

Procedure

Troubleshooting 75

Appendix

Technical Information 77

Serial terminal.....77

Other terminals

Two window display combination list
(PT-FW430U Only).....82

List of compatible signals.....83

Restoring the MENU LOCK PASSWORD to
default.....84

Specifications 85

Dimensions

Ceiling mount bracket safeguards..... 87

Index 88

Precautions for Use

Cautions when transporting

- When transporting the projector, hold it securely by its bottom and avoid excessive vibration and impacts. Doing so may damage the internal parts and result in malfunctions.
- Do not transport the projector with the adjustable feet extended. Doing so may damage the adjustable feet.

Cautions when installing

■ Do not set up the projector outdoors.

- The projector is designed for indoor use only.

■ Do not use under the following conditions.

- Places where vibration and impacts occur such as in a car or vehicle: Doing so may damage the internal parts and result in malfunctions.
- Near the exhaust of an air conditioner or near lights (studio lamps, etc.) where temperature changes greatly (Operating environment ➔ page 86): Doing so may shorten the life of the lamp or result in deformation of the outer case and malfunctions.
- Near high-voltage power lines or near motors: Doing so may interfere with the operation of the projector.

■ Be sure to ask authorized personnel or your supplier when mounting the product to a ceiling

This requires an optional ceiling mount bracket.

Product No.: ET-PKF110H (for high ceilings), ET-PKF110S (for low ceilings)

- Consult your supplier if you need ceiling mount brackets ET-PKF100H (for high ceilings) or ET-PKF100S (for low ceilings) for projectors PT-F300 or PT-FW300.

■ Be sure to set [HIGH ALTITUDE MODE] to [ON] when using the projector at elevations of 1400 m (4593 ft) or higher and lower than 2700 m (8858 ft) above sea level.

Failure to do so may shorten the life of the internal parts and result in malfunctions.

■ Be sure to set [HIGH ALTITUDE MODE] to [OFF] when using the projector at elevations lower than 1400 m (4593 ft) above sea level.

Failure to do so may shorten the life of the internal parts and result in malfunctions.

■ Do not install the projector at elevations of 2700 m (8858 ft) or higher above sea level.

Failure to do so may shorten the life of the internal parts and result in malfunctions.

■ Do not use the projector installed vertically or tilted right or left (➔ page 21)

Using the projector at a vertical angle that exceeds 30° may reduce product life or result in malfunction.

Cautions when setting the projectors

- Do not stack the projectors.
- Do not block the ventilation ports (intake and exhaust) of the projector.
- Avoid heating and cooling air from the air conditioning system directly blow to the ventilation ports (intake and exhaust) of the projector.

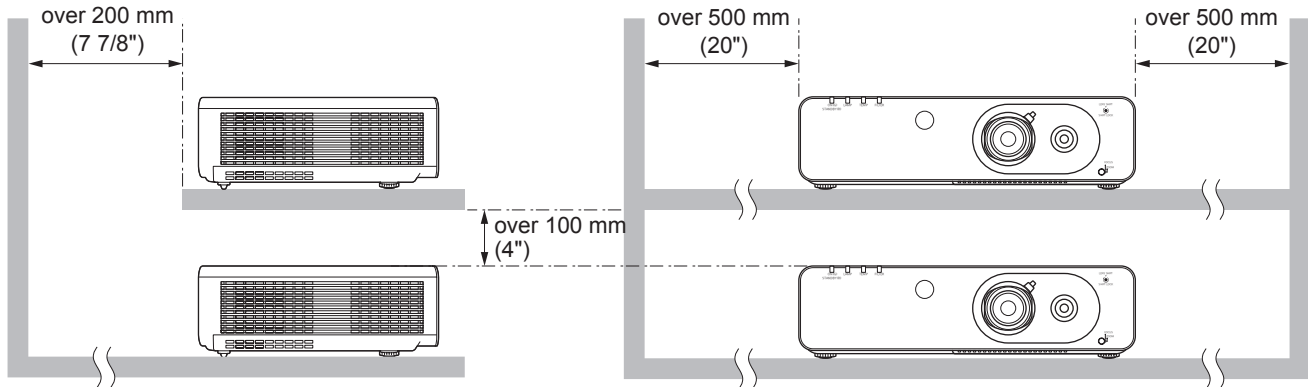
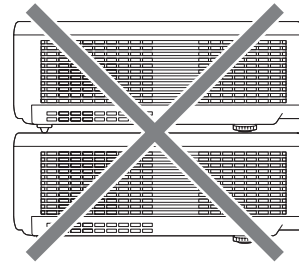

- Do not place the projector in an enclosed space.
If you need to place the projector in an enclosed space, additional air conditioning and ventilation system must be equipped. When ventilation is insufficient, remaining heat may trigger the protection circuit of the projector.

Security

Take safety measures against following incidents.

- Personal information being leaked via this product.
- Unauthorized operation of this product by a malicious third party.
- Interfering or stopping of this product by a malicious third party.

Security instruction (➔page 64)

- Make your password as difficult to guess as possible.
- Change your password periodically.
- Panasonic or its affiliate company never inquires a password directly to a customer. Do not tell your password in case you receive such an inquiry.
- The connecting network must be secured by firewall or others.
- Set a password and restrict the users who can log in.

Disposal

The lamp contains mercury. When discarding used lamp units, contact your local authorities or dealer for correct methods of disposal.

Precautions for Use

Cautions on use

■ In order to get the picture quality

- Draw curtains or blinds over windows and turn off any lights near the screen to prevent outside light or light from indoor lamps from shining onto the screen.
- Depending on where the projector is used, heated air from an exhaust port or warm or cold air from an air conditioner can cause a shimmering effect on screen.
Avoid use in locations where exhaust or streams of air from projector, other devices and air conditioners flow between the projector and the screen.
- The lens of projector is affected by the heat from the luminous source. Because of this, the focusing stays unstable right after the power is turned on. Focusing is stabled after projecting image for 30 minutes and longer.

■ Do not touch the surface of the projector lens with your bare hand.

If the surface of the lens becomes dirty from fingerprints or anything else, this will be magnified and projected onto the screen.

■ LCD Panel

The display unit of this projector comprises three LCD panels. Although an LCD panel is a product of high-precision technology, some of the pixels on the projected image may be missing or constantly lit. Please note that this is not a malfunction.

Displaying a still image for a longer time may result in an after-image on the LCD panels. If this happens, display the all white screen in the test pattern (➡ page 63) for an hour or more. Note that it may not be possible to completely remove the after-image.

■ Optical components

Operating the projector in an environment with high temperature or heavy exposure to dust or tobacco smoke will reduce the service life of the optical components, such as the LCD panel and polarizing plate, and may necessitate their replacement within less than one year of use. For details, consult your dealer.

■ Lamp

The luminous source of the projector is a mercury lamp with high internal pressure.

A high pressure mercury lamp has following characteristics.

- The brightness of the lamp will decrease by duration of usage.
- Impact, damage, deterioration from wear and other factors may end the life of the lamp, for example, by causing it to burst with a loud noise.
- The life of the lamp varies greatly depending on individual specificities and usage conditions. In particular, continuous use over 12 hours and frequent on/off switching of the power greatly deteriorate the lamp and affect the lamp life.
- In rare cases, the lamp burst shortly after the projection.
- The risk of bursting increases when the lamp is used beyond its replacement cycle. Make sure to replace the lamp unit consistently. ("When to replace the lamp unit" (➡ page 72))
- If the lamp bursts, gas contained inside of the lamp is released in a form of smoke.
- It is recommended to store replacement lamps for contingency.
- It is recommended to have authorized engineer or your dealer replace the lamp unit.

CAUTION

To connect the projector to a computer or other external device, be sure to use only the supplied power cords and commercially available shielded cables.

<Software information regarding this product>

© Panasonic Corporation 2011

This product incorporates the following software:

(1) the software which is developed independently by or for Panasonic Corporation

(2) the software which is licensed under the GNU GENERAL PUBLIC LICENSE,

and

(3) the software which is licensed under the GNU LESSER GENERAL PUBLIC LICENSE.

For the software categorized as (2) and (3), the license is available in accordance with GNU GENERAL PUBLIC LICENSE and GNU LESSER GENERAL PUBLIC LICENSE respectively. As for the terms and conditions, please refer to the software licence of the supplied CD-ROM.

If you wish to ask any questions as to the software, please contact (sav.pj.gpl.pavc@ml.jp.panasonic.com) by email.

Accessories

Make sure the following accessories are provided with your projector. Numbers in the brackets () show the number of accessories.

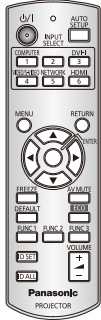
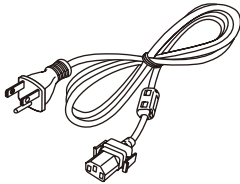
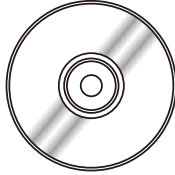
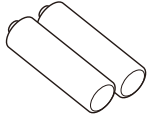
Wireless remote control unit (x1) (N2QAYB000669)	Power cord (x1) (TXFSX01RTNZ)	CD-ROM (x1) (TXFQB02VKP7)	Batteries (AA/R6 type) (x2)
			 (for remote control unit)

Attention

- After unpacking the projector, discard the power cord cap and packaging material properly.
- For lost accessories, consult your dealer.
- The part numbers of accessories and separately sold components are subject to change without notice.
- Store small parts in an appropriate manner, and keep them away from young children.

Contents of the supplied CD-ROM

The contents of the supplied CD-ROM are as follow.

[●: Instructions/List (PDF), ○: Software]

- **Operating Instructions – Projector Operations.**
- **Operating Instructions – Network Operations.**
- **Multi Projector Monitoring & Control Software 2.5(Windows)**
 - This software allows you to monitor and control multiple projectors connected to the LAN.
- **Operation Manual Multi Projector Monitoring & Control Software 2.5**
- **Logo Transfer Software 2.0(Windows)**
 - This software allows you to create original images, such as company logos to be displayed when projection starts, and transfer them to the projector.
- **Operation Manual Logo Transfer Software 2.0**
- **Wireless Manager ME5.5(Windows/Macintosh)**
 - This software allows you to send computer screen displays over wireless/wired LAN.
- **Operation Manual Wireless Manager ME5.5**
- **List of compatible projector models**
 - This is a list of projectors that are compatible with the software marked with the “○” symbols above, and their restrictions.
- **Software license**
(GNU GENERAL PUBLIC LICENSE and GNU LESSER GENERAL PUBLIC LICENSE)

Optional accessories

Options	Model No.
Ceiling Mount Bracket	ET-PKF110H*1 (for high ceilings), ET-PKF110S*1 (for low ceilings)
Replacement Lamp Unit	ET-LAF100A
Replacement Filter Unit	ET-EMF100
Wireless Module	ET-WM200U
Easy Wireless Stick	ET-UW100

*1 : Be sure to consult your dealer when using the ceiling mount bracket for the PT-F300U/PT-FW300U (ET-PKF100H for high ceilings or ET-PKF100S for low ceilings).

Start-up display

The LANGUAGE and INITIAL SETTING menu will be displayed when the projector is turned on for the first time after purchase, or after doing INITIALIZE ALL (➔page 63). Set them in accordance with circumstances. In other occasions, you can change the settings navigating MENU.

Note

- When the projector is turned on for the first time, you may be required to adjust the zoom lever and focus lever (➔page 31) in the front of the projector body to make the menu screen clearer.
For details, see "How to adjust the state of the image". (➔page 31)

INITIAL SETTING (display language)

Select the language to show on the screen. (➔page 48)

- Press ▲▼◀▶ to select the desired language.

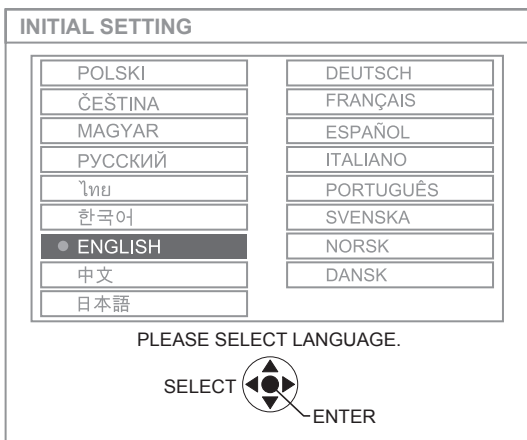

- Press the <ENTER> button, to proceed to INITIAL SETTING.

INITIAL SETTING (projector setup)

Select the item from the menus of [PROJECTION METHOD], [SCREEN FORMAT], [SCREEN POSITION], AND [HIGH ALTITUDE MODE].

- Press ▲▼ to select the desired menu.
- Press ◀▶ to change the settings in the menu.

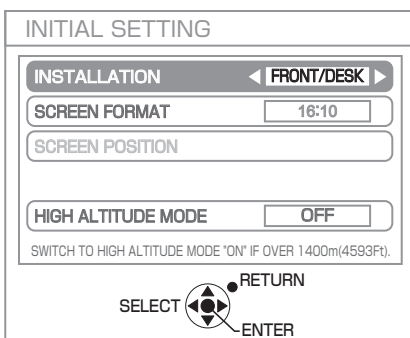

(screen for PT-FW430U)

- PROJECTION METHOD (➔page 57)

FRONT/DESK	Setting on a desk or other in front of the screen
FRONT/CEILING	Mounting on the ceiling using the ceiling mount bracket (option) in front of the screen
REAR/DESK	Setting on a desk or other behind the screen (using translucent screen)
REAR/CEILING	Mounting on the ceiling using the ceiling mount bracket (option) behind the screen (using translucent screen)

- SCREEN FORMAT (➔page 51)
[PT-FW430U only]

16:10	When projecting on a 16:10 or 4:3 screen
16:9	When projecting on a 16:9 screen

- SCREEN POSITION (➔page 51)
[PT-FW430U only]

*: Selectable only when [SCREEN FORMAT] is [16:9].

LOW	Displays the menu in the lower part of the screen.
CENTER	Displays the menu in the middle of the screen.
HIGH	Displays the menu in the upper part of the screen.

- HIGH ALTITUDE MODE (➔page 57)

OFF	When operating at low altitude (less than 1400 m (4593 ft) above sea level)
ON	When operating at high altitude (between 1400 m (4593 ft) and 2700 m (8858 ft) above sea level)

- Press <ENTER> to complete the setting.

Note

- If you press [RETURN] in the [INITIAL SETTING] menu, you can go back to the [LANGUAGE] menu.

About Your Projector

Remote control

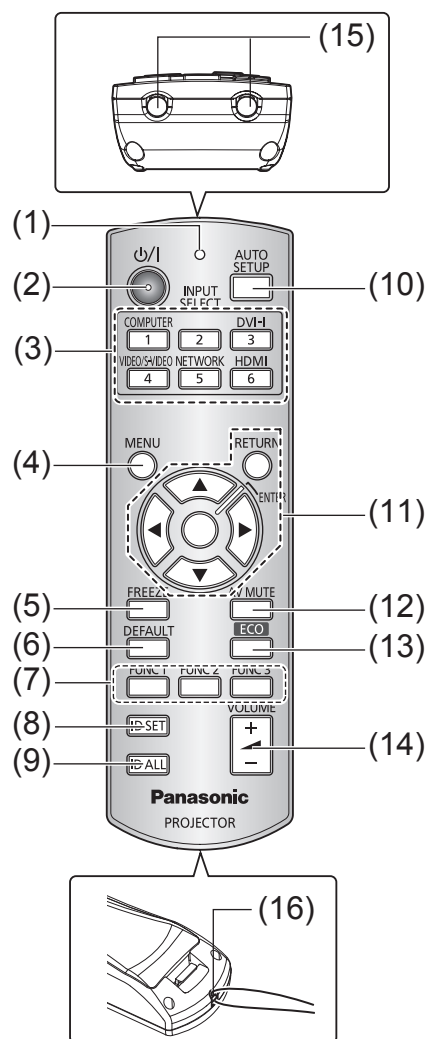

(1) Remote control indicator

Flashes by pressing any button

(2) <POWER> Button

Turns power [on]/[off] when the main power switch on the rear of the projector is [ON].

(3) Input Selection Buttons; <COMPUTER>, <DVI-I>, <VIDEO/S-VIDEO>, <NETWORK>, <HDMI>

These buttons select the input signal. (➔page 32)
These are also used to set the ID of the remote control.

(4) <MENU> Button

Displays the MENU display. (➔page 35)

(5) <FREEZE> Button

Pauses the projected image and sound tentatively. (➔page 32)

(6) <DEFAULT> Button

Restores the settings of SUB MENU to the factory default. (➔page 33)

(7) <FUNC 1> to <FUNC 3> Buttons

You can assign frequently used functions to these buttons and use them as shortcuts. (➔page 60)

(8) <ID SET> Button

Specifies the ID of the remote control, when operating a system with multiple projector units. (➔page 20)

(9) <ID ALL> Button

Makes the remote control operate any projector, when operating a system with multiple projector units. (➔page 20)

(10) <AUTO SETUP> Button

Corrects the picture positioning on the screen automatically during projection.
While the auto setup feature is active, [AUTO SETUP] appears on the screen. (➔page 33)

(11) ▲ ▼ ◀ ▶ Buttons, <RETURN> Button, <ENTER> Button

Navigate the MENU display.
These are also used when inputting passwords in [SECURITY] or when inputting characters.

(12) <AV MUTE> Button

Turns off the projection and the sound tentatively. (➔page 32)

(13) <ECO> Button

Opens the [ECO MANAGEMENT] menu. (➔page 33)

(14) <VOLUME> Button (+/-)

Adjusts the volume of the speaker. (➔page 34)

(15) Remote control signal emitters

(16) Strap hole

You can attach a strap onto the remote control for your convenience.

Attention

- Do not drop the remote control.
- Avoid contact with liquids.
- Do not attempt to modify or disassemble the remote control.
- When strap is attached to the remote control, do not fling the remote control while holding the strap.

Note

- The remote control can be used within a distance of about 15 m (49.2 ft) if pointed directly at the remote control signal receiver. The remote control can control at angles of up to $\pm 15^\circ$ vertically and $\pm 30^\circ$ horizontally, but the effective control range may be reduced.
- If there are any obstacles between the remote control and the remote control signal receiver, the remote control may not operate correctly.
- You can operate the projector by reflecting the remote control signal on the screen. The operating range may differ due to the loss of light caused by the properties of the screen.
- When the remote control signal receiver is lit with a fluorescent light or other strong light source, the projector may become inoperative. Set the projector as far from the luminous source as possible.

About Your Projector

Projector body

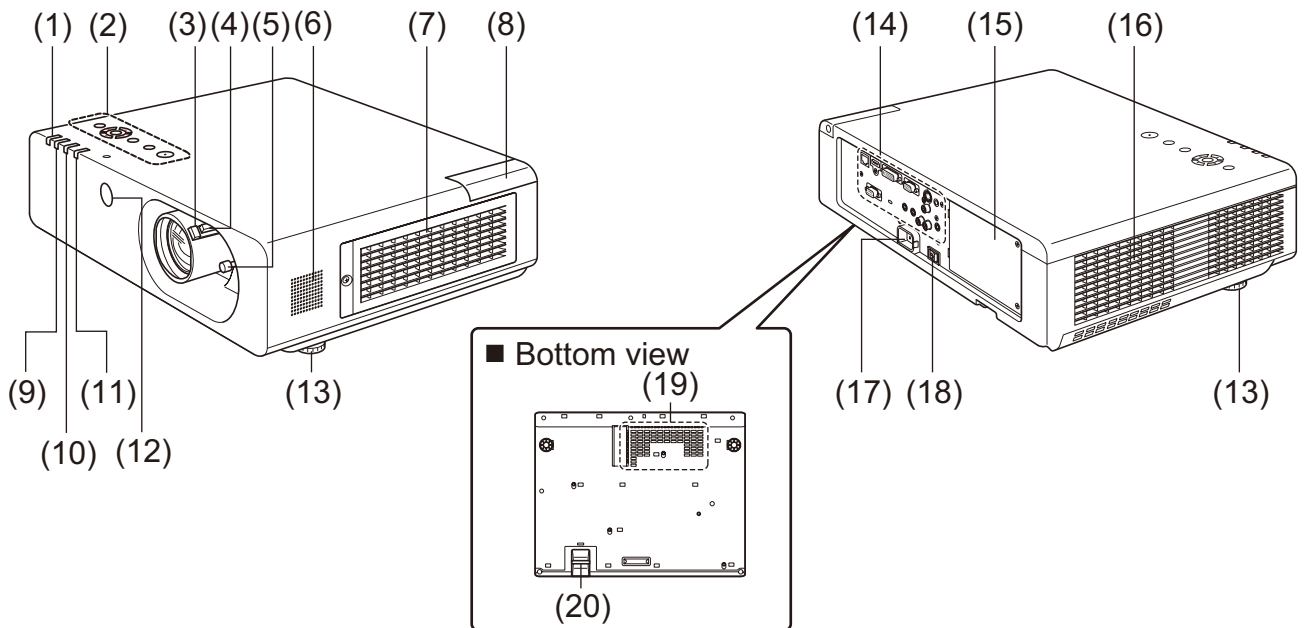

(1) Power indicator (STANDBY(R) / ON(G))

Indicates the power supply status

(2) CONTROL PANEL (➔page 19)

(3) Focus lever

Adjusts the focus.

(4) Zoom lever

Adjusts the zoom.

(5) Lens shift lever

Adjusts the position of the projected image.

(6) Speaker

(7) Air intake port / Air filter cover

The air filter unit is located inside. (➔page 70)

(8) Wireless module cover

The wireless module connection terminal is located inside. (➔page 74)

(9) Lamp indicator (LAMP)

Indicates the lamp unit status.

(10) Temperature indicator (TEMP)

Indicates the temperature status inside of the projector.

(11) Filter indicator

Indicates the state of the air filter unit.

(12) Remote control signal receiver (front)

(13) Front adjustable feet

Adjusts the projection angle.

(14) Rear terminals (➔page 19)

(15) Lamp cover (➔page 73)

The lamp unit is located inside.

(16) Air exhaust port

(17) AC IN terminal

Connects to the supplied power cord.
(➔page 28)

(18) <MAIN POWER> switch

Turns the MAIN POWER to [ON]/[OFF].

(19) Air intake port

(20) Security bar

Attach an anti-theft cable here.

WARNING:

■ Keep your hands and other objects away from the air exhaust port.

- Keep your hand and face away.
- Do not insert your finger.
- Keep heat-sensitive articles away.

Heated air from the air exhaust port can cause burns or external damage.

CONTROL PANEL

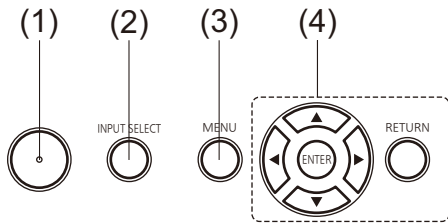

(1) Power <⏻/⏻> button

Turns power on/off when the main power switch on the rear of the projector is [ON].

(2) <INPUT SELECT> button

Selects the input signal. (➔page 32)

(3) <MENU> button

Displays the MENU screen. (➔page 35)

(4) ▲ ▼ ◀ ▶ buttons, <RETURN> button, <ENTER> button

Navigate the MENU screen.

Rear terminals

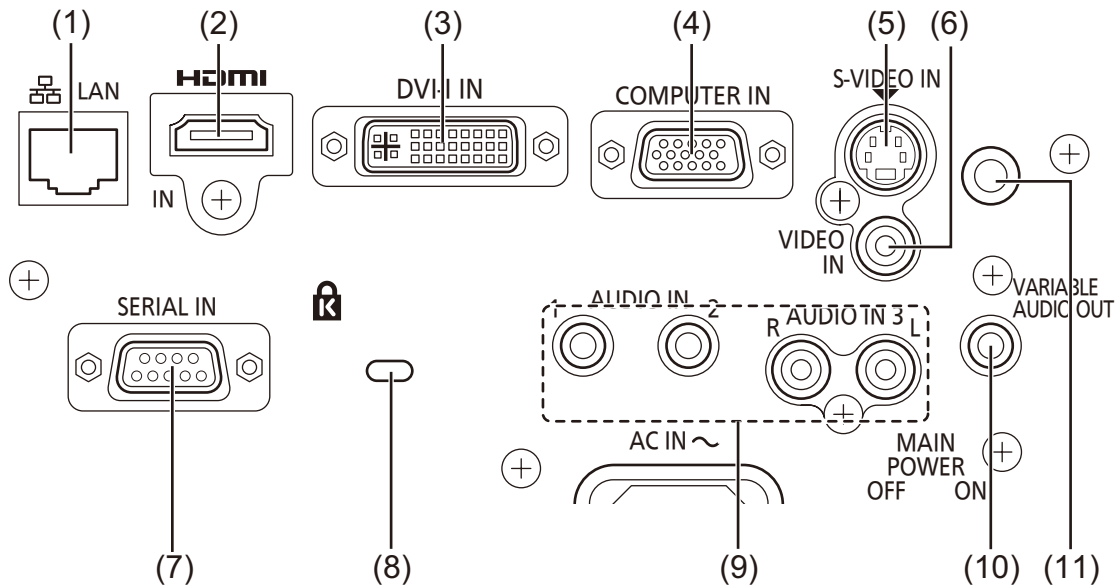

(1) LAN

Connects to a LAN cable for network connection.

(2) HDMI IN

Connects to HDMI input signals.

(3) DVI-I IN

Connects to DVI-D, DVI-A (RGB or YP_BP_R) input signals.

(4) COMPUTER IN

Connects to RGB or YP_BP_R input signals.

(5) S-VIDEO IN

Connects to S-VIDEO input signals.

(6) VIDEO IN

Connects to VIDEO input signals.

(7) SERIAL IN

Connects to a computer via an RS-232C cable.

(8) Security slot

Attach the commercial shackle lock, manufactured by Kensington, to protect your projector. Compatible with the Kensington MicroSaver Security System.

(9) AUDIO IN 1-3

Connects to the audio input signals. AUDIO IN 3 has right and left (L and R) terminals.

(10) VARIABLE AUDIO OUT

Outputs the audio signals input to the projector.

(11) Remote control signal receiver(rear)

Attention

- When a LAN cable is directly connected to the projector, the network connection must be made indoors.

Using Remote control

Installing and removing batteries

1) Open the cover

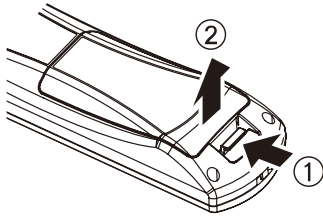

2) Install batteries and close the cover

(Insert the – side first.)

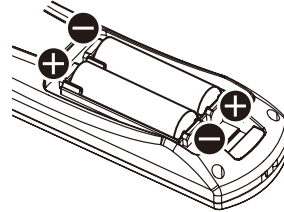

- Remove the batteries in the reverse order of installation.

Setting Remote control ID numbers

When you use the system with multiple projectors, you can operate all the projectors simultaneously or each projector individually using single remote control, if unique ID number is assigned to each projector. After setting the ID number of the projector, set the same ID number to the remote control.

The factory default of the projector's ID number is [ALL]. When using single projector, use the <ID ALL> button of the remote control. If you are not sure of the ID number of the projector, set the ID of the projector to [ALL] pressing the <ID ALL> button of the remote control.

Setting the ID number

Press <ID SET> button, then input the projector's ID number using numeric keys (<1> to <6>) within 5 seconds.

If the <ID ALL> button is pressed, you can operate the projectors regardless the setting of the projectors' ID numbers. (Simultaneous control mode)

Attention

- Do not press <ID SET> button carelessly because the ID number on the remote control can be set even when no projector is around. If you press <ID SET> and do not press the numeric key (<1> to <6>) within 5 seconds, the ID will remain the same as before <ID SET> button was pressed.
- Your specified ID number is stored in the remote control unless another one is specified later. However, the stored ID will be erased if the batteries of the remote control are replaced or depleted. When the batteries are replaced, set the same ID number again.

Note

- For the setting of the projector's ID number, see "PROJECTOR ID" of "PROJECTOR SETUP" (➔page 56).

Setting up

Projection method

You can use the projector with any of the following 4 projection methods. To set the desired method in the projector.

■ Mounting on the ceiling and projecting forward

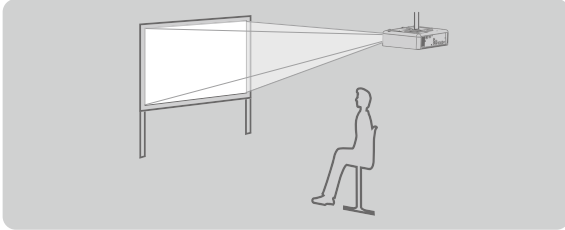

Menu *	Method
PROJECTION METHOD	FRONT/CEILING

■ Setting on a desk/floor and projecting from rear

(Using translucent screen)

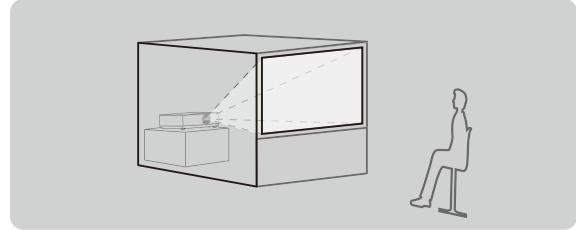

Menu *	Method
PROJECTION METHOD	REAR/DESK

■ Mounting on the ceiling and projecting from rear

(Using translucent screen)

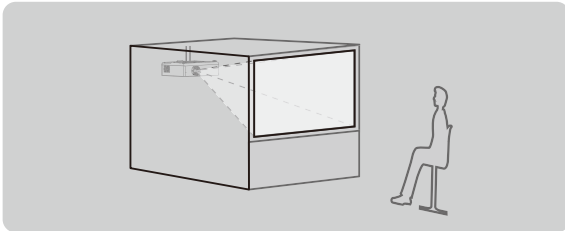

Menu *	Method
PROJECTION METHOD	REAR/CEILING

■ Setting on a desk/floor and projecting forward

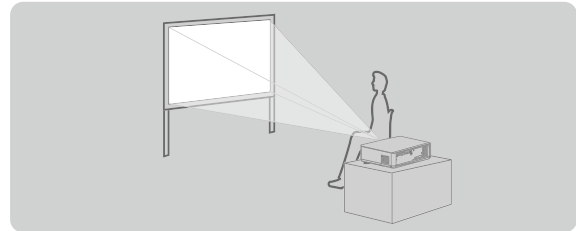

Menu *	Method
PROJECTION METHOD	FRONT/DESK

*: Refer to "PROJECTION METHOD" of "PROJECTION SETUP menu" (▶ pages 57) for details.

Attention

- For optimum viewing quality, install the projector in a location where screen exposure to outside light, light from light fixtures or other light is at a minimum. Also draw the curtains, close blinds and turn off light fixtures.
- Do not use the projector installed vertically or tilted right or left. Use under such conditions could result in equipment damage.
- The projector must be installed so that its inclination to the horizontal plane is $\pm 30^\circ$ or less.
- Installing the projector at an inclination that exceeds 30° may reduce product life or result in malfunction.

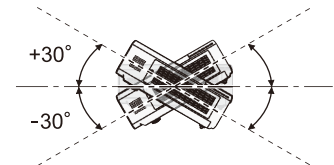

Parts for ceiling mount (Optional)

You can install the projector on the ceiling using the optional ceiling mount bracket (ET-PKF110H: for high ceiling, ET-PKF110S: for low ceiling).

- Use only the ceiling mount brackets specified for this projector.
- Refer to the installation manual for the ceiling mount bracket when you install the bracket and the projector.
- Be sure to consult your dealer when using the ceiling mount bracket for the PT-F300U/PT-FW300U (ET-PKF100H for high ceilings or ET-PKF100S for low ceilings).

Attention

- To ensure projector performance and security, installation of the ceiling mount bracket must be carried by your dealer or a qualified technician.

Setting up

Screen size and throw distance

Place the projector referring to the diagram on the right and the figures of throwing distance. You can adjust the display size

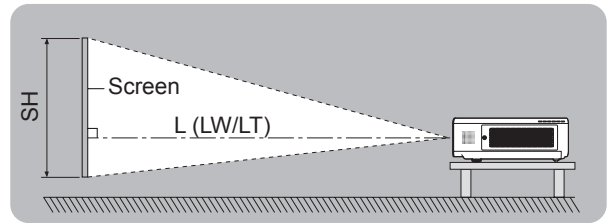
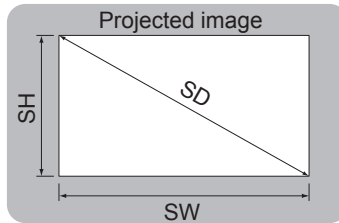

L (LW/LT) *1	Projection distance (m)
SH	Height of the projection area (m)
SW	Width of the projection area (m)
SD	Diagonal length of the projection area (m)

*1 : LW : Minimum distance
LT : Maximum distance

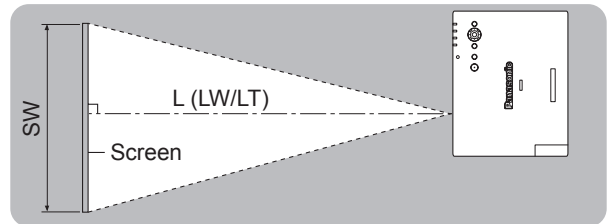

Attention

- Before installing, please read "Precautions for Use" (➡ pages 12 to 15)

Projection distance for PT-FW430U

(All measurements below are approximate and may differ slightly from the actual measurements.)

Projection size Screen diagonal (SD)	For 4:3 aspect ratio		For 16:9 aspect ratio		For 16:10 aspect ratio	
	Minimum distance (LW)	Maximum distance (LT)	Minimum distance (LW)	Maximum distance (LT)	Minimum distance (LW)	Maximum distance (LT)
0.84 m(33")	-	2.1 m(6.89')	-	1.9 m(6.23')	-	1.8 m(5.91')
1.02 m(40")	1.3 m(4.27')	2.6 m(8.53')	1.2 m(3.94')	2.3 m(7.55')	1.1 m(3.61')	2.3 m(7.55')
1.27 m(50")	1.6 m(5.25')	3.2 m(10.50')	1.5 m(4.92')	2.9 m(9.51')	1.4 m(4.59')	2.8 m(9.19')
1.52 m(60")	1.9 m(6.23')	3.9 m(12.80')	1.7 m(5.58')	3.5 m(11.48')	1.7 m(5.58')	3.4 m(11.15')
1.78 m(70")	2.3 m(7.55')	4.5 m(14.76')	2.0 m(6.56')	4.1 m(13.45')	2.0 m(6.56')	4.0 m(13.12')
2.03 m(80")	2.6 m(8.53')	5.2 m(17.06')	2.3 m(7.55')	4.7 m(15.42')	2.3 m(7.55')	4.6 m(15.09')
2.29 m(90")	2.9 m(9.51')	5.8 m(19.03')	2.6 m(8.53')	5.3 m(17.39')	2.6 m(8.53')	5.1 m(16.73')
2.54 m(100")	3.2 m(10.50')	6.5 m(21.33')	2.9 m(9.51')	5.9 m(19.36')	2.9 m(9.51')	5.7 m(18.70')
3.05 m(120")	3.9 m(12.80')	7.8 m(25.59')	3.5 m(11.48')	7.1 m(23.29')	3.4 m(11.15')	6.9 m(22.64')
3.81 m(150")	4.9 m(16.08')	9.8 m(32.15')	4.4 m(14.44')	8.8 m(28.87')	4.3 m(14.11')	8.6 m(28.21')
5.08 m(200")	6.5 m(21.33')	13.0 m(42.65')	5.9 m(19.36')	11.8 m(38.71')	5.7 m(18.70')	11.5 m(37.73')
6.35 m(250")	8.2 m(26.90')	16.3 m(53.48')	7.4 m(24.28')	14.7 m(48.23')	7.2 m(23.62')	14.3 m(46.92')
7.62 m(300")	9.8 m(32.15')	19.5 m(63.98')	8.9 m(29.20')	17.7 m(58.07')	8.6 m(28.21')	17.2 m(56.43')

Any other projection distance can be obtained according to the screen dimensions (m) using the following calculations.

The distance is shown in units of meters. (The calculated distance may contain a certain error.)

If the screen dimensions are written as "SD",

	For 4:3 aspect ratio	For 16:9 aspect ratio	For 16:10 aspect ratio
Screen height (SH)	= SD(m) × 0.6	= SD(m) × 0.490	= SD(m) × 0.530
Screen width (SW)	= SD(m) × 0.8	= SD(m) × 0.872	= SD(m) × 0.848
Minimum distance (LW)	= 1.3346 × SD(m) - 0.052	= 1.1693 × SD(m) - 0.045	= 1.1378 × SD(m) - 0.046
Maximum distance (LT)	= 2.5709 × SD(m) - 0.052	= 2.3307 × SD(m) - 0.061	= 2.2677 × SD(m) - 0.061

■ Projection distance for PT-FX400U

(All measurements below are approximate and may differ slightly from the actual measurements.)

Projection size	For 4:3 aspect ratio		For 16:9 aspect ratio	
	Minimum distance (LW)	Maximum distance (LT)	Minimum distance (LW)	Maximum distance (LT)
0.84 m(33")	-	1.9 m(6.23')	-	2.1 m(6.89')
1.02 m(40")	1.2 m(3.94')	2.3 m(7.55')	1.3 m(4.27')	2.5 m(8.20')
1.27 m(50")	1.5 m(4.92')	3.0 m(9.84')	1.7 m(5.58')	3.2 m(10.50')
1.52 m(60")	1.8 m(5.91')	3.6 m(11.81')	2.0 m(6.56')	3.8 m(12.47')
1.78 m(70")	2.1 m(6.89')	4.2 m(13.78')	2.3 m(7.55')	4.5 m(14.76')
2.03 m(80")	2.4 m(7.87')	4.8 m(15.75')	2.7 m(8.86')	5.2 m(17.06')
2.29 m(90")	2.7 m(8.86')	5.4 m(17.72')	3.0 m(9.84')	5.8 m(19.03')
2.54 m(100")	3.0 m(9.84')	6.0 m(19.68')	3.3 m(10.83')	6.5 m(21.33')
3.05 m(120")	3.6 m(11.81')	7.2 m(23.62')	4.0 m(13.12')	7.8 m(25.59')
3.81 m(150")	4.5 m(14.76')	9.0 m(29.53')	5.0 m(16.40')	9.8 m(32.15')
5.08 m(200")	6.1 m(20.01')	12.0 m(39.37')	6.6 m(21.65')	13.1 m(42.98')
6.35 m(250")	7.6 m(24.93')	15.1 m(49.54')	8.3 m(27.23')	16.4 m(53.81')
7.62 m(300")	9.1 m(29.86')	18.1 m(59.38')	10.0 m(32.81')	19.7 m(64.63')

Any other projection distance can be obtained according to the screen dimensions (m) using the following calculations.

The distance is shown in units of meters. (The calculated distance may contain a certain error.)

If the screen dimensions are written as "SD",

	For 4:3 aspect ratio	For 16:9 aspect ratio
Screen height (SH)	= SD(m) × 0.6	= SD(m) × 0.490
Screen width (SW)	= SD(m) × 0.8	= SD(m) × 0.872
Minimum distance (LW)	= 1.2008 × SD(m) - 0.049	= 1.3071 × SD(m) - 0.053
Maximum distance (LT)	= 2.3780 × SD(m) - 0.05	= 2.3465 × SD(m) - 0.055

Setting up

Adjusting front adjustable feet

You can turn the front adjustable feet to extend them. You can turn them in the opposite direction to contract them.

(You can adjust the projection angle vertically.)

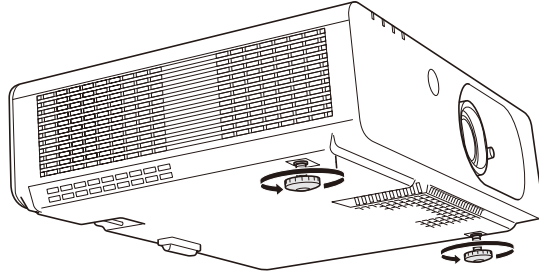

Adjustable range
Front adjustable feet : 19 mm(3/4")

Attention

- Heated air comes out of the air exhaust port while the lamp is lit. Do not touch the air exhaust port directly when you adjust the front adjustable feet.
- If keystone distortion occurs on the projected image, perform "KEYSTONE" from the "Position" menu. (➔page 42)

Note

- Screw up the adjustable feet, and an audible click will be heard as the limit.

Adjusting the position using the lens shift function

If the projector is not positioned right in front of the center of the screen, you can adjust the projected image position by moving the lens shift lever within the shift range of the lens.

■ Adjusting the lens shift

1) Screw the lens shift lever as shown (counterclockwise) to unlock.

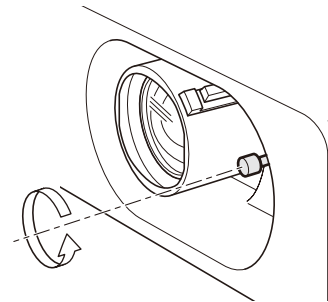

2) Adjust the projection moving the lens shift lever.

Move the lens shift lever to adjust the projected image position.
(Shows the example of the projector on the floor projecting forward)

- Horizontal shift

In accordance with the position of the screen and the projector, shift the lens shift lever right or left.

PT-FW430U : Up to about 24 % of the projection
PT-FX400U : Up to about 27 % of the projection

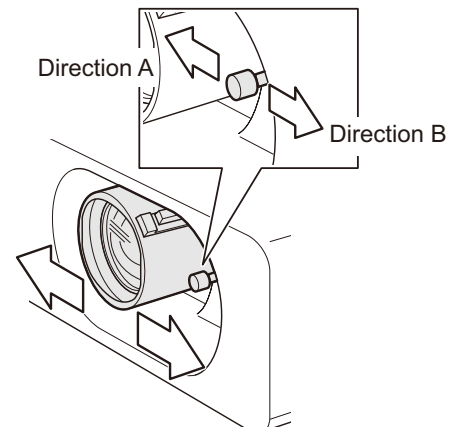
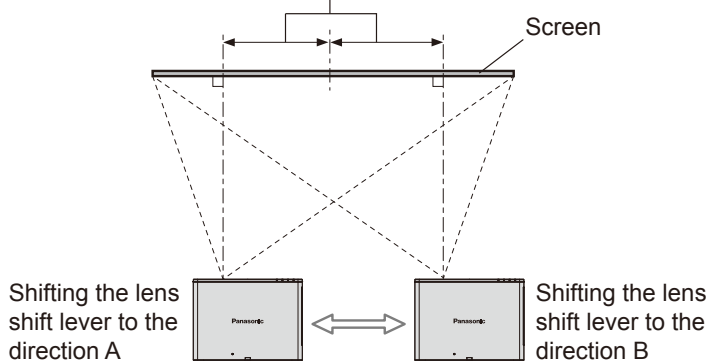

- Vertical shift

In accordance with the position of the screen and the projector, shift the lens shift lever up or down.

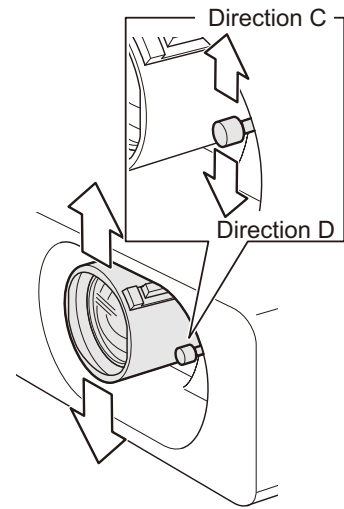
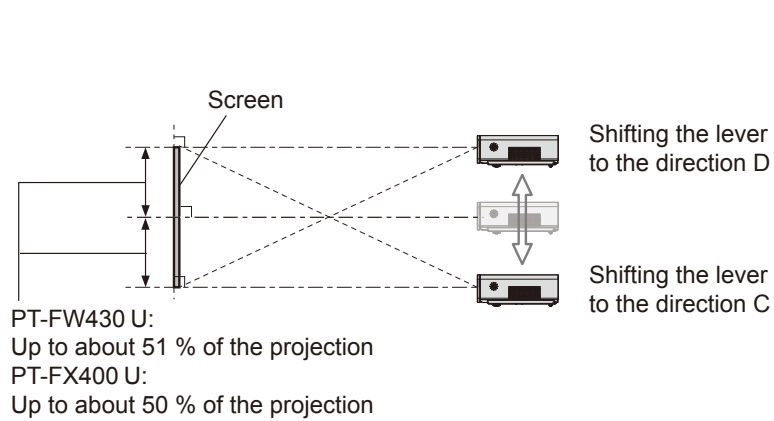

3) Screw the lens shift lever as shown (clockwise) to lock.

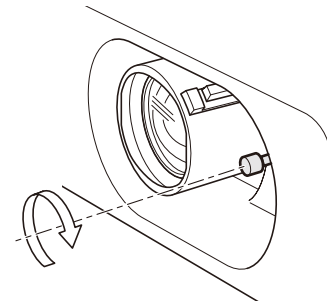

Setting up

Projector location range

You can adjust the location of the projector within following limits.

For the screen height (SH) and the screen width (SV), see "Screen size and throw distance" (▶page 22)

- Settable range of the projector, when the screen position is fixed

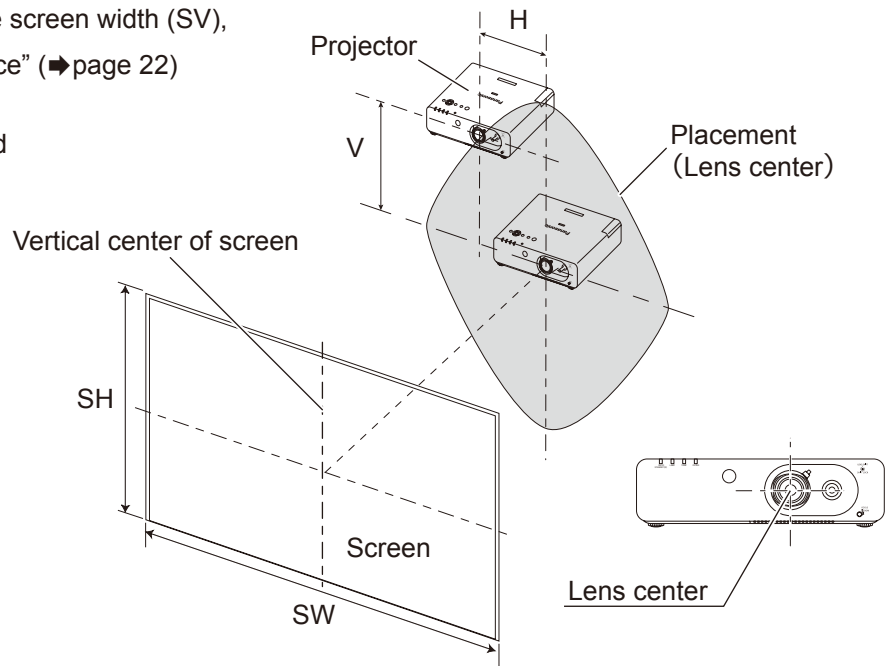

- Shift range of the screen, when the projector position is fixed

●PT-FW430U (16:10)

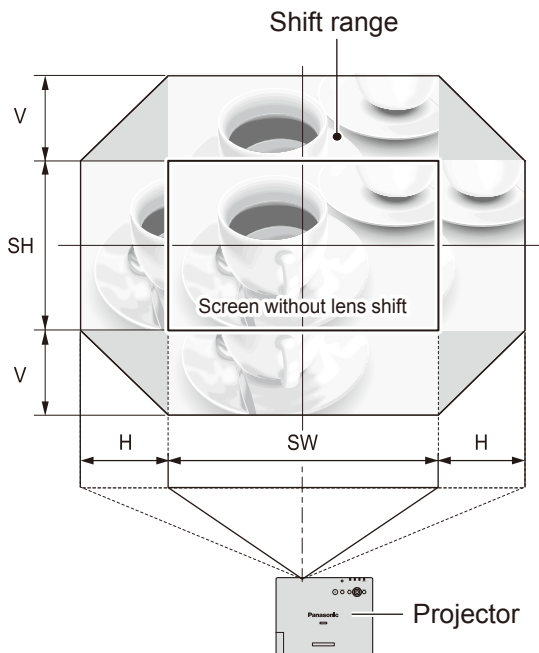

●PT-FX400U

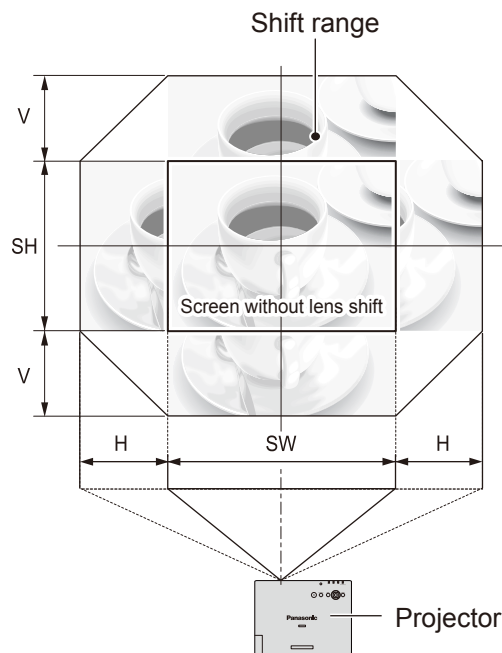

Lens shift direction	Limit of adjustment
Horizontal (H)	Up to 24 % of the screen width (SW)
Vertical (V)	Up to 51 % of the screen height (SH)

Lens shift direction	Limit of adjustment
Horizontal (H)	Up to 27 % of the screen width (SW)
Vertical (V)	Up to 50 % of the screen height (SH)

Note

- When the projector is located right in front of the screen and the lens shift lever is centered, you will get the best quality of the projection image.
- When the lens shift lever is at the horizontal limit of the shift range, you cannot move the lever to the vertical limit, likewise when the lens shift lever is at the vertical limit of the shift range, you cannot move the lever to the horizontal limit.
- When the projector is tilted and you adjust KEYSTONE, the center of the screen and the lens need to be realigned.

Connections

Before connecting to the projector

- Read carefully the instruction manual for the device to be connected.
- Turn off the power switch of the devices before connecting cables.
- If any connection cable is not supplied with the device, or if no optional cable is available for connection of the device, prepare a necessary system connection cable to suit the device.
- Video signals containing too much jitter may cause the images on the screen to randomly wobble or wafture. In this case, a time base corrector (TBC) must be connected.
- The projector accepts the following signals: VIDEO, S-VIDEO, analog-RGB (with TTL sync. Level) and digital signals.
- Some computer models are not compatible with the projector.
- When using long cables to connect with each of equipment to the projector, there is a possibility that the image will not be output correctly unless a compensator is used.
- For details on what video signals the projector supports, see “List of compatible signals”. (▶page 83)

Connecting example

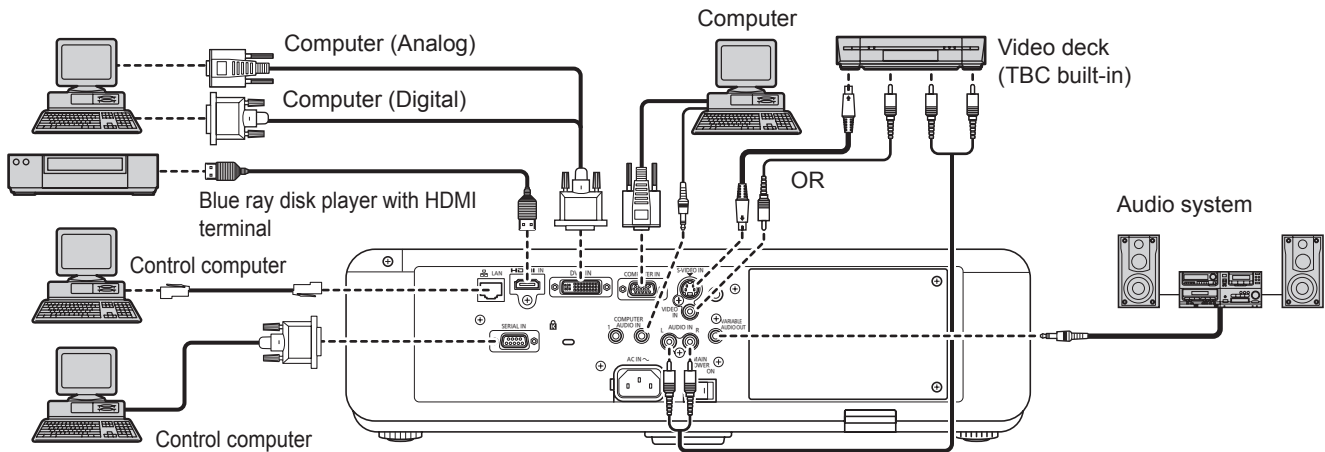

Attention

- When connecting with a video deck, be sure to use the one with a built-in time base corrector (TBC) or use a TBC between the projector and the video deck.
- If nonstandard burst signals are connected, the image may be distorted. If this is the case, connect a TBC between the projector and the video deck.

Note

- Use only HDMI High Speed cables that comply with the HDMI standard. Use of HDMI cables that do not conform to the HDMI standard may fail to display an image at all, cause image flicker and other problems.
- It is possible to connect the HDMI input terminal with an external device having a DVI terminal using an HDMI/DVI conversion cable, but with some devices the images may not appear or other problems may occur. (▶page 50)
- It is possible to connect the DVI-I input terminal with an HDMI- or DVI-I compliant device, but with some devices the images may not appear or other problems may be encountered in operation. (▶page 50)
- When [AUDIO IN SELECT] is not set correctly, sound may not be heard and other problems may occur. (▶page 61)
- This projector does not support the Viera link (HDMI).
- Use a computer input terminal or DVI-I terminal to input YP_BP_R signals.
- The DVI-I input terminal (digital signal input) supports only a single link.
- For the specifications of the RGB signals that can be applied from the PC, refer to “List of compatible signals”. (▶page 83)
- If your computer has the resume feature (last memory), the computer may not function properly until the resume capability is disabled.
- When the SYNC ON GREEN signal is input, do not input sync signals to the SYNC/HD and VD terminals.
- When using the DVI-I input terminal (digital signal input), EDID settings may be required for some connected devices. (▶page 50)
- See “Network operation” in the instruction manual on the supplied CD-ROM for the details of wired LAN and wireless communication between the projector and the computer.

Powering ON/OFF

Connecting the power cord

Be sure to Insert the attached power cord securely to its base to prevent it from coming off.
Before connecting the power cord, confirm that the MAIN POWER switch is in the “○” (OFF) position.

■ Installation

Insert the plug securely until its right and left claw click.

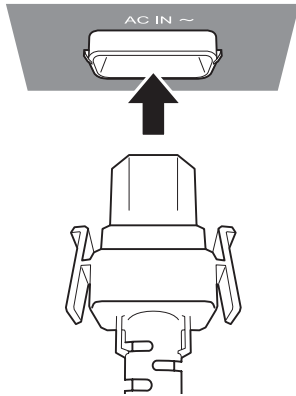

■ Removal

Remove the power cord from the electrical outlet while pressing the knobs on its sides.

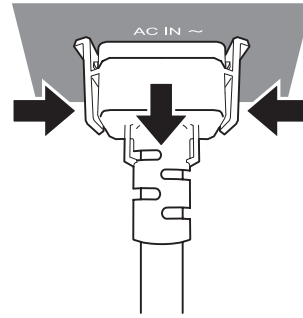

Power indicator

The power indicator informs you the status of the power. Confirm the status of the <Power indicator> before operating the projector.

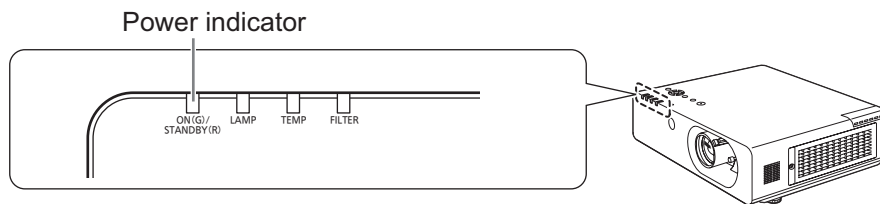

Indicator status		Status
No illumination or flashing		The MAIN POWER is switched off.
RED	Lit	The power is switched off (When [STANDBY MODE] is set to [ECO]). Press the POWER (⏻) button to start the projection. When the LAMP or TEMP indicator is flashing, you cannot operate. (▶page 68)
	Flashing	The power is switched off (When [STANDBY MODE] is set to [NORMAL]). Press the POWER (⏻) button to start the projection. When the LAMP or TEMP indicator is flashing, you cannot operate. (▶page 68)
GREEN	Flashing	The power is switched on and the projector is getting ready to project. Projection will start momentarily.
	Lit	Projecting.
ORANGE	Lit	The projector is getting ready to be switched off. The power will be switched off (standby mode) momentarily.
	Flashing	The POWER (⏻) button is pressed while the projector is getting ready to be switched off. Projection will start momentarily.

Note

- When the projector is getting ready to be switched off (<POWER INDICATOR> is lit in orange), the internal cooling fan is operating to cool the projector.
- It may take a while to start the projection if the POWER (⏻) button is pressed while the projector is getting ready to be switched off.
- Electricity is consumed even when the power is off (<POWER INDICATOR> is lit in red).

Powering up the projector

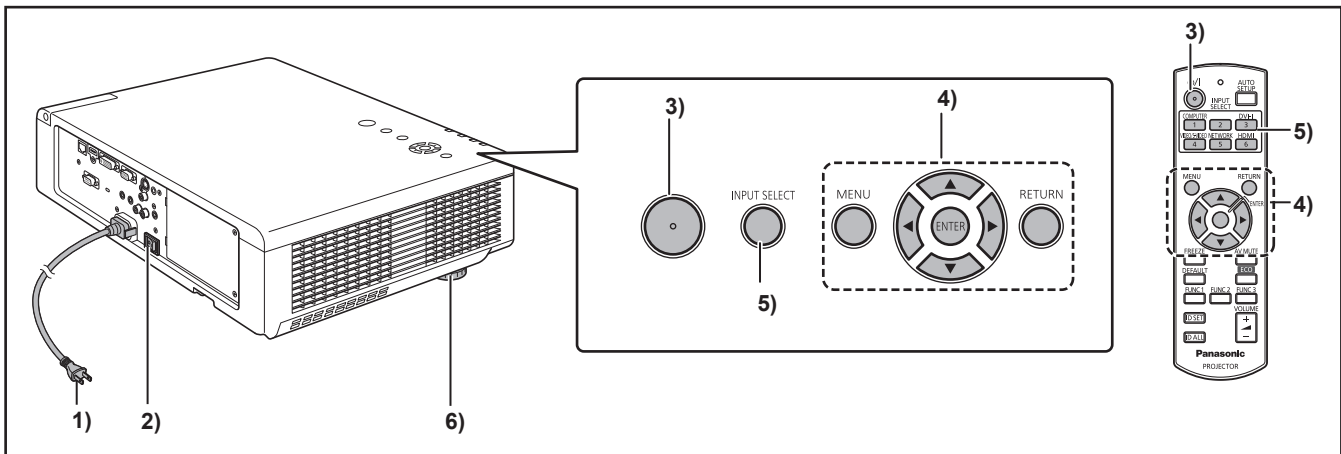

Remove the lens cover before turning on the projector.

- 1) **Connect the power plug to the outlet.**
(AC100 V-240 V 50 Hz-60 Hz)
- 2) **Press the [ON] side of the <MAIN POWER> switch to turn on the power.**
Soon, the <Power indicator> lights red or blinks and the projector enters standby mode.
- 3) **Press the Power (⏻/⏷) button.**
<Power indicator> lamp illuminates in green and soon the image is projected on the screen.

Note

- In the [SECURITY] menu, check that [CONTROL PANEL] (when operating from the projector) or [REMOTE CONTROLLER] (when using the remote control) in the [CONTROL DEVICE SETUP] is set to [ENABLE]. (➔page 66)
You must enter a password to make settings in the [SECURITY] menu. (➔page 64)
- The lamp makes a low frizzling sound when lit which is normal and not a malfunction.
- During video projection, the cooling fan turns making a sound. Fan sound may change with ambient temperature and becomes louder when the lamp is lit.
- When the lamp is turned off and immediately turned back on again, the video may temporarily flicker slightly at the start of projection due to lamp characteristics but this is not a malfunction.
- When [ECO] is selected in [STANDBY MODE] (➔page 59) in [ECO MANAGEMENT] under the "PROJECTOR SETUP menu", the initial image may appear about 10 seconds later than when set to [NORMAL].
- If the direct power function was used to set the MAIN POWER switch to [OFF] during projection and [LAST MEMORY] had been selected under [INITIAL START UP] in the [PROJECTOR SETUP] menu, the next time the <MAIN POWER> switch is set to [ON] when the power plug is connected to an AC outlet, the <Power indicator> will soon light green and an image will be projected.

Making adjustment and selection

It is recommended that the images are projected continuously for at least 30 minutes before the focus is adjusted.

- 4) **Set the initial settings. (➔page 16)**
The screen to set the display language and the [INITIAL SETTING] menu screen to set other initial settings will appear when you turn on the power for the first time after purchase or when you perform [PROJECTOR SETUP] - [INITIALIZE ALL]. (➔page 63)
- 5) **Select the input signal by pressing the <COMPUTER>, <DVI-I>, <VIDEO/S-VIDEO>, <NETWORK>, or <HDMI> button or the <INPUT SELECT> button.**
- 6) **Adjust the projection angle. (➔page 24)**
You can adjust the projection angle upward by extending the front adjustable feet.

Powering ON/OFF

Powering off the projector

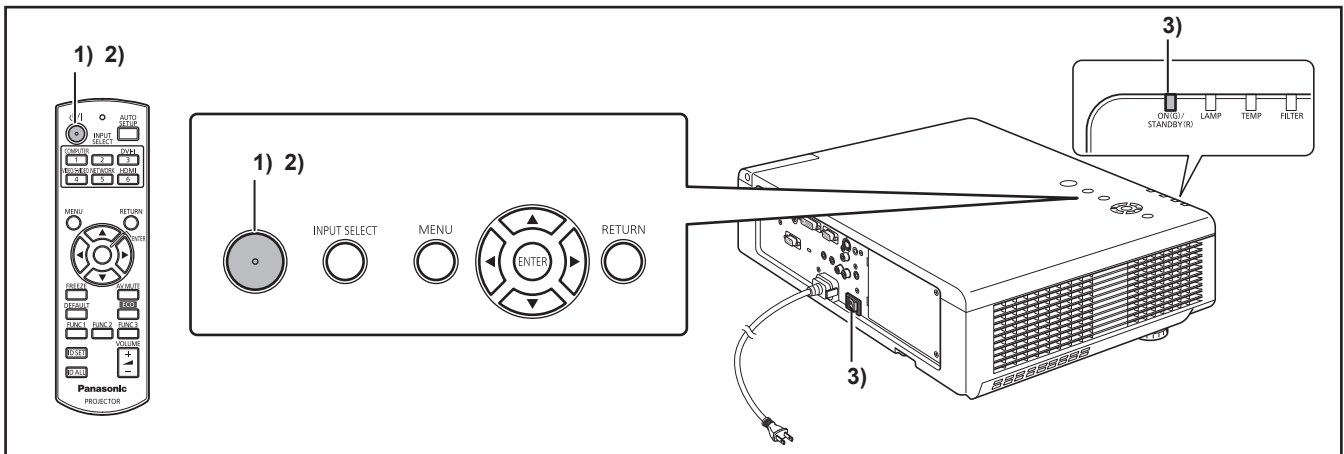

- 1) Press the POWER (⏻/⏷) button.**

The "POWER OFF" confirmation screen appears.

 - Pressing any button other than the POWER (⏻/⏷) button or leaving the projector idle for 10 seconds will clear the "POWER OFF" confirmation screen.
- 2) Pressing the POWER (⏻/⏷) button again will turn off the lamp, a beep sound will be heard and projection stops.**
 - The cooling fan will continue turning and the <Power indicator> will light orange. Wait until the <Power indicator> turns red.
 - When [STANDBY MODE] is set to [NORMAL], the <Power indicator> will blink red.
 - The beep sound heard when pressing the POWER (⏻/⏷) button can be turned "ON" or "OFF" with the "AUDIO SETTING" in the "PROJECTOR SETUP" menu. (➔page 61)
- 3) When the <Power indicator> is red, set the <MAIN POWER> switch to [OFF] to turn the projector off.**

Note

- Do not turn on the power immediately after turning it off.

The lamp may not light when you turn on the power while the luminous lamp is in cooling state after the power is turned off. Turn the power on after the <Power indicator> lights in red. If you turn the power on while the temperature of the lamp is high, it may shorten the lamp life.
- The projector consumes power when you turn off the projector pressing [OFF] on the remote control while the <MAIN POWER> of the projector is [ON]. For details on power consumption, see "Power consumption" in the "Specifications". (➔page 85)
- In the [SECURITY] menu, check that [CONTROL PANEL] (when operating from the projector) or [REMOTE CONTROLLER] (when using the remote control) in the [CONTROL DEVICE SETUP] is set to [ENABLE]. (➔page 66)

Direct power off function

Even if you turn the <MAIN POWER> switch [OFF] during projection or just after the lamp turns off, the cooling fan will continue to rotate using internally stored power. In cases where the <MAIN POWER> switch is not easily accessible, such as during ceiling mount, you can safely turn off the power by using the power breaker switch. This function also works if a power outage occurs or if the power cable is accidentally disconnected from the outlet right after turning the power off.

Note

- If projection was stopped by turning the power breaker switch off and you turn the power breaker back on, the <Power indicator> will light in green and projection will start again. (Only when the [INITIAL START UP] is set to [LAST MEMORY] or [ON]. (➔page 56))
- When the lamp has been cooled by the direct power off function, it sometimes takes longer than usual for the lamp to light up again.
- While the cooling fan is operating, do not place the projector inside a box or bag.

Projecting

Check the connections of the peripheral devices (➔page 27) and connection of the power cord (➔page 28) and switch on the power (➔page 29) to start the projector. Select the image and adjust the state of the image.

Selecting the image

Select an input signal.

The image selected with the <COMPUTER>, <DVI-I>, <VIDEO/S-VIDEO>, <NETWORK>, or <HDMI> button is projected. (➔page 32)

Attention

- Images may not be projected properly depending on the connected device and DVD, video tape, etc. to be played. Select a system format that is suitable for the input signal in [TV SYSTEM] or [RGB/YP_BPR] in the [PICTURE] menu (➔page 41).
- Check the aspect ratio of the screen and the image and select the optimum aspect ratio using [ASPECT] in the [PICTURE] menu (➔page 44).

How to adjust the state of the image

1) Screw [Lens shift lever] counterclockwise to unlock [Lens shift lever].

2) Adjust the lens shift.

Adjust the projection position by moving [Lens shift lever].

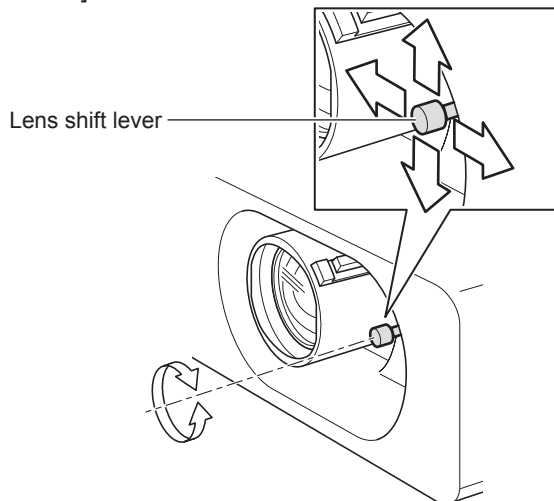

- For details of the adjustable range, see “Adjusting the position using the lens shift function”. (➔page 24)

3) Screw [Lens shift lever] clockwise to lock [Lens shift lever].

4) Adjust the projection angle.

- For details, see “Adjusting front adjustable feet”. (➔page 24)

5) Adjust the zoom and the focus.

Turn [Zoom lever] and [Focus lever] to adjust the image.

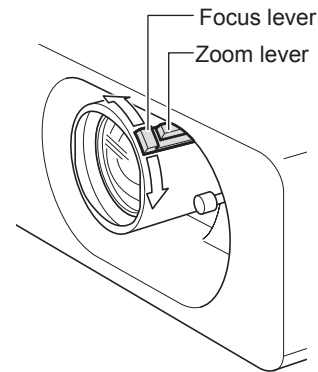

Note

- It is recommended that the images are projected continuously for at least 30 minutes before the focus is adjusted.
- If you adjust the focus, you may need to adjust the size of the image by moving the zoom lever again.
- If keystone distortion occurs, see “KEYSTONE” (➔page 42).

Basic operations using the remote control

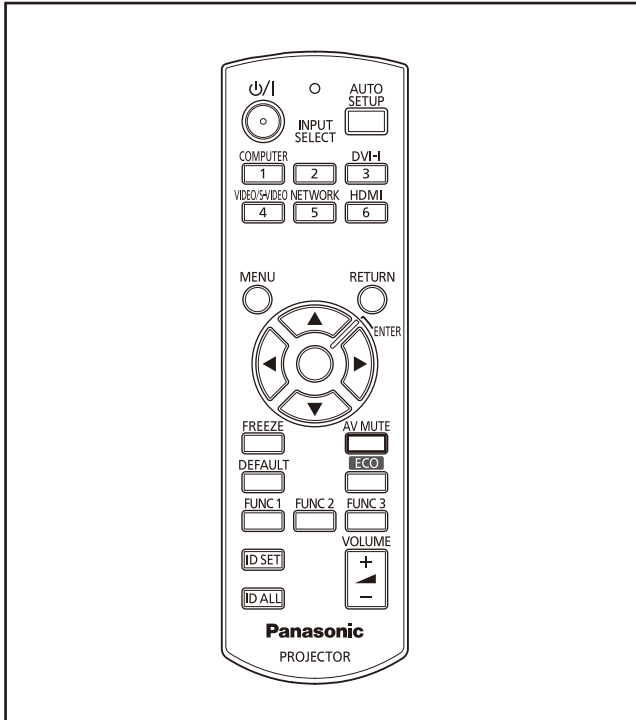

Using the AV MUTE function

If the projector is not used for a certain period of time during the meeting intermission, for example, an AV MUTE mode is available that allows the user to mute the sound and to hide images temporarily.

AV MUTE
 **button**

- 1) Press <AV MUTE> button on the remote control.
 - The image disappears and the sound is muted.
- 2) Press <AV MUTE> button again.
 - The image and the sound resume.

Using the FREEZE function

You can freeze the projected image and stop the sound temporarily, regardless of the playing condition of the connected device.

FREEZE
 **button**

- 1) Press <FREEZE> button on the remote control.
 - The image freezes and the sound is muted.
- 2) Press <FREEZE> button again.
 - The image unfreezes and the sound resumes.

Note

- "FREEZE" is displayed on the screen while the freeze function is enabled.

Switching the input signal

You can switch the input signals to project.

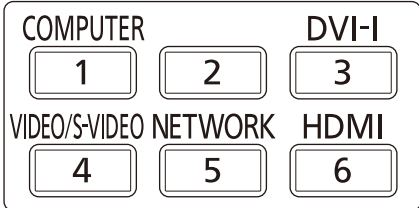
INPUT SELECT
 **button**

Press <INPUT SELECT> (<COMPUTER>, <DVI-I>, <VIDEO/S-VIDEO>, <NETWORK>, or <HDMI>) button on the remote control.

COMPUTER	Switches to COMPUTER input.
DVI-I	Switches to DVI-I input.
VIDEO/S-VIDEO	Switches to VIDEO or S-VIDEO.
NETWORK	Switches to NETWORK input.
HDMI	Switches to HDMI input.

Note

- Each press of the <INPUT SELECT> button on the Control Panel of the main unit switches the settings as shown below. (➡page 19)



Adjusting the display position automatically

This function allows you to automatically adjust [SHIFT], [DOT CLOCK] and [CLOCK PHASE] during signal input from a computer.



Press the <AUTO SETUP> button on the remote control.

Note

- Only [SHIFT] is automatically adjusted during DVI digital and HDMI signal input.
- A search for input is made when there is no signal. (When [SIGNALSEARCH] is set to [ON]) (➔page 53)
- When signals exceeding DOT CLOCK 162 MHz are input, [DOT CLOCK] and [CLOCK PHASE] cannot be automatically set. (➔page 43)
- When "AUTO SETUP" is used on images with blurred edges or dark images, operation may automatically stop. Should this happen, switch to a different image and press the <AUTO SETUP> button again.

Using the function buttons

Three function buttons (<FUNC 1> to <FUNC 3>) on the remote control can be assigned to any frequent operations. They can be used as a useful shortcut button.



Press any of the <FUNC 1> to <FUNC 3> buttons on the remote control.

Note

- For details, see "FUNCTION BUTTON" of "PROJECTOR SETUP". (➔page 60)

Using ECO button

Displays [ECO MANAGEMENT] menu.



Press the <ECO> button on the remote control.

Note

- For details, see "ECO MANAGEMENT" of "PROJECTOR SETUP". (➔page 59)

Resetting to the factory default

Use the DEFAULT button to return a submenu setting or adjustment value to its factory default.



Press <DEFAULT> button on the remote control

Note

- For details, see "Resetting to the factory default" in "Menu Navigation" under "Navigating through the menu". (➔page 35)

Basic operations using the remote control

Controlling the volume of the speaker

You can control the volume of the projector's speaker or audio output.

VOLUME

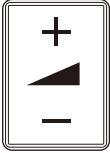

button

Press <VOLUME> (+/-) button on the remote control.

+ button	increases the volume
- button	decreases the volume

Menu Navigation

Navigating through the menu

Operating procedure

1) Press the <MENU> button.

The [MAIN MENU] screen appears.

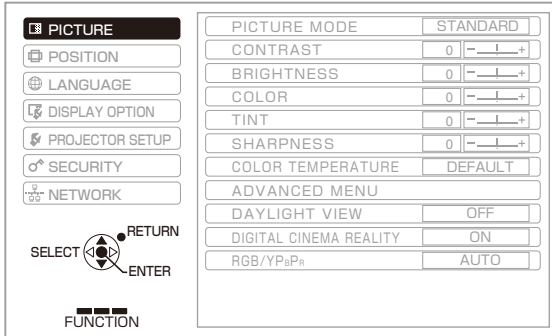

2) Press the ▲ ▼ buttons to select the [MAIN MENU] item.

Select the desired item from the seven items: [PICTURE], [POSITION], [DISPLAY LANGUAGE], [DISPLAY OPTION], [PROJECTOR SETUP], [SECURITY], and [NETWORK]. The selected item is highlighted with an orange cursor and the sub-menu of the selected item appears on the right.

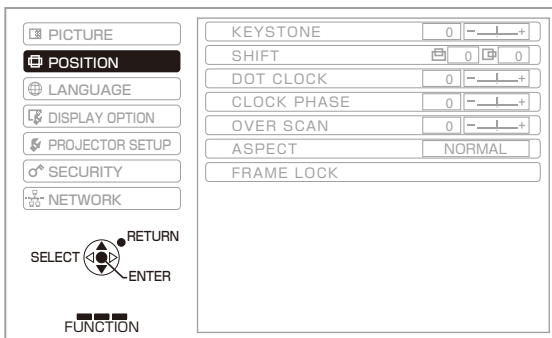

3) Press the <ENTER> button.

The sub-menu appears so that you can select the sub-menu item.

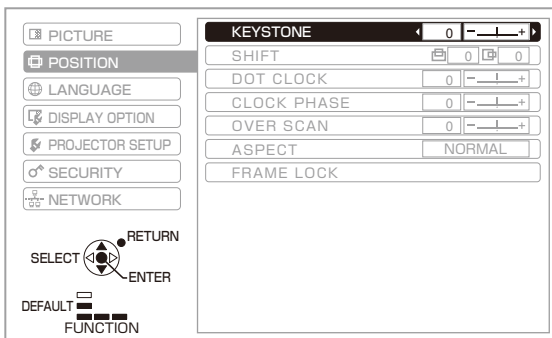

4) Press the ▲ ▼ buttons to select the desired sub-menu item, then press the ◀ ▶ buttons to change the settings or adjust the parameter values.

For some items with a setting screen and a bar scale, the MENU display disappears and only the selected item (individual setting screen) will appear as shown in the diagram below.



When only the name of the item appears, press the <ENTER> button to go to the next screen for detailed settings.

Note

- On the MENU screen, press the <RETURN> or <MENU> button to return to the previous menu.
- Some items may not be adjusted or used for certain signal formats input to the projector. The MENU items that cannot be adjusted or used are shown in gray characters, and they cannot be selected.
- Some items can be adjusted even if signals are not input.
- If no operation is made for approx. 5 seconds, the individual setting screen automatically disappears.
- See page 36 and 37 for details on the items of sub-menu.

Resetting to the factory default

If the <DEFAULT> button of the remote control is pressed, the values set in the MENU items will be restored to the factory default settings.



This function differs depending on the displayed screen.

- **When the sub-menu screen is displayed:**
The settings of the displayed sub-menu items are restored to the factory default.
- **When the individual setting screen is displayed:**
Only the item currently adjusted are restored to the factory default.



Note

- You cannot reset all the settings to the factory default at a time.
To reset all the settings adjusted in the [MENU] items to the factory defaults, refer to "INITIALIZE ALL" in "PROJECTOR SETUP". (▶ page 63)
- Some menu items cannot be reset by pressing the <DEFAULT> button. Adjust each menu item manually.
- The triangle mark under the bar indicates the factory default setting.
The triangle mark position varies by the selected input signals.

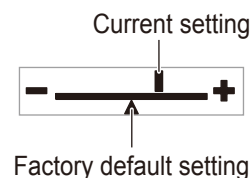







Menu Navigation

MAIN MENU

The main menu consists of the following 7 menu items.

When a main menu item is selected, the screen changes to a sub-menu selection screen.

	PICTURE
	POSITION
	LANGUAGE
	DISPLAY OPTION
	PROJECTOR SETUP
	SECURITY
	NETWORK

SUB MENU

The sub-menu screen of the selected main menu appears, and you can set and adjust the various items in the sub-menu.

PICTURE []

Sub-menu item	Factory default	Page
PICTURE MODE	STANDARD *1	38
CONTRAST	0	38
BRIGHTNESS	0	38
COLOR	0	39
TINT	0	39
SHARPNESS	0	39
COLOR TEMPERATURE	DEFAULT	39
ADVANCED MENU	-	40
DAYLIGHT VIEW	AUTO	40
DIGITAL CINEMA REALITY	ON	40
NOISE REDUCTION	OFF	41
TV-SYSTEM	AUTO	41
RGB/YP _B PR	AUTO *1	41

*1 : Depends on signal input.

Note

- The factory default values may vary depending on the PICTURE MODE.
- Sub-menu items and factory default values differ depending on the selected input terminal.

POSITION []

Sub-menu item	Factory default	Page
KEystone	0	42
SHIFT	0	42
SHIFT V *1	0	42
DOT CLOCK	0	43
CLOCK PHASE	0	43
OVER SCAN	0	43
ASPECT	NORMAL *2	44
FRAME LOCK	OFF	47

*1 : PT-FW430U only

Appears only when [H FIT] is selected for the [ASPECT] of the network input.

*2 : Depends on signal input.

Note

- Sub-menu items and factory default values differ depending on the selected input terminal.

■ LANGUAGE []

Details (➔page 48)

■ DISPLAY OPTION[]

Sub-menu item	Factory default	Page
ON-SCREEN DISPLAY	-	49
DVI-I IN	-	50
HDMI IN	-	50
CLOSED CAPTION SETTING	OFF	51
SCREEN SETTING	-	51
STARTUP LOGO	DEFAULT LOGO	52
AUTO SETUP	AUTO	52
SIGNAL SEARCH	ON	53
BACK COLOR	BLUE	53
WIDE MODE	AUTO	53
SXGA MODE	SXGA	53
OTHER FUNCTIONS		54

■ PROJECTOR SETUP[]

Sub-menu item	Factory default	Page
STATUS	-	56
PROJECTOR ID	ALL	56
INITIAL START UP	LAST MEMORY	56
PROJECTION METHOD	FRONT/DESK	57
HIGH ALTITUDE MODE	OFF	57
LAMP POWER	NORMAL	57
SCHEDULE	OFF	58
ECO MANAGEMENT	-	59
EMULATE	DEFAULT	60
FUNCTION BUTTON	-	60
AUDIO SETTING	-	61
DATE AND TIME	-	62
TEST PATTERN	-	63
INITIALIZE ALL	-	63

■ SECURITY []

Sub-menu item	Default	Page
PASSWORD	OFF	64
PASSWORD CHANGE	-	64
DISPLAY SETTING	OFF	65
TEXT CHANGE	-	65
MENU LOCK	OFF	65
MENU LOCK PASSWORD	-	65
CONTROL DEVICE SETUP	-	66

■ NETWORK []

Refer to “Operating Instructions, Network Operations”.

Sub-menu item	Factory default
WIRED LAN	-
WIRELESS LAN	S-MAP *1
NAME CHANGE	-
PASSWORD	OFF
PASSWORD CHANGE	-
NETWORK CONTROL	ON
LIVE MODE CUT IN	OFF
COMPUTER SEARCH	-
MULTI-LIVE	-
STATUS	-
INITIALIZE	-

*1 : Only when the optional wireless module is installed.

PICTURE menu

Select [PICTURE] from the Main Menu (see “Navigating through the menu” on page 35), then select the item from the sub-menu.

- After selecting the item, press ◀▶ to set.

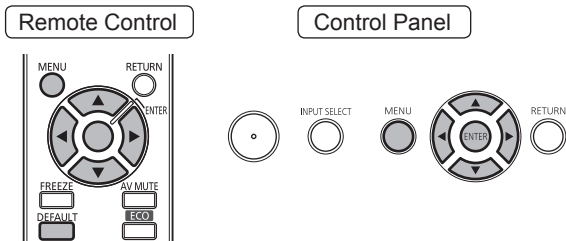

PICTURE MODE

You can switch to the desired picture mode suitable for the image source and the environment in which the projector is used.

- 1) Press ▲▼ to select [PICTURE MODE].
- 2) Press ◀▶ or the <ENTER> button.
 - The [PICTURE MODE] screen appears.
- 3) Press ◀▶ to switch the [PICTURE MODE].
 - The setting will change as follows each time you press the button.



*1 : During video input

*2 : During still image input

STANDARD	For viewing at normal brightness
DYNAMIC	For viewing at higher brightness and sharpness
BLACKBOARD	For projection on a blackboard
WHITE BOARD	For projection on a whiteboard
CINEMA	For natural reproduction of film sources
NATURAL	For reproduction in a dark room

Note

- The factory default picture mode settings are [DYNAMIC] for still images and [STANDARD] for video.
- It may take a few seconds for the picture to stabilize after a picture mode change.

CONTRAST

You can adjust the contrast of the colors.

- 1) Press ▲▼ to select [CONTRAST].
- 2) Press ◀▶ or the <ENTER> button.
 - The [CONTRAST] screen will be displayed.
- 3) Press ◀▶ to adjust the level.

Operation	Adjustment	Adjustment range
Press ▶.	Brightens the screen and makes the color of image deeper.	Maximum value +32
Press ◀.	Darkens the screen and makes the color of image lighter.	Minimum value -32

Attention

- Adjust the BRIGHTNESS in advance if necessary.

BRIGHTNESS

You can adjust the dark (black) parts of the projected image.

- 1) Press ▲▼ to select [BRIGHTNESS].
- 2) Press ◀▶ or the <ENTER> button.
 - The [BRIGHTNESS] screen will be displayed.
- 3) Press ◀▶ to adjust the level.

Operation	Adjustment	Adjustment range
Press ▶.	Increases the brightness of the dark (black) parts of the screen.	Maximum value +32
Press ◀.	Reduces the brightness of the dark (black) parts of the screen.	Minimum value -32

COLOR

You can adjust the color saturation of the projected image.

- 1) Press ▲▼ to select [COLOR].
- 2) Press ◀▶ or the <ENTER> button.
 - The [COLOR] screen will be displayed.
- 3) Press ◀▶ to adjust the level.

Operation	Adjustment	Adjustment range
Press ▶.	Deepens colors.	Maximum value +32
Press ◀.	Weakens colors.	Minimum value -32

TINT

You can adjust the skin tone in the projected image.

- 1) Press ▲▼ to select [TINT].
- 2) Press ◀▶ or the <ENTER> button.
 - The [TINT] screen will be displayed.
- 3) Press ◀▶ to adjust the level.

Operation	Adjustment	Adjustment range
Press ▶.	Adjusts skin tone toward greenish color.	Maximum value +32
Press ◀.	Adjusts skin tone toward reddish-purple.	Minimum value -32

SHARPNESS

This adjusts the sharpness of the pictures.

- 1) Press ▲▼ to select [SHARPNESS].
- 2) Press ◀▶ or the <ENTER> button.
 - The [SHARPNESS] screen will be displayed.
- 3) Press ◀▶ to adjust the level.

Operation	Adjustment	Adjustment range
Press ▶.	Contours become sharper.	Depends on signal input.
Press ◀.	Contours become softer.	

COLOR TEMPERATURE

Please switch if the white areas of the image are bluish or reddish.

- 1) Press ▲▼ to select [COLOR TEMPERATURE].
- 2) Press ◀▶ or the <ENTER> button.
 - The [COLOR TEMPERATURE] individual adjustment screen will be displayed.
- 3) Press ◀▶ to switch [COLOR TEMPERATURE].
 - The setting will change as follows each time you press the button.

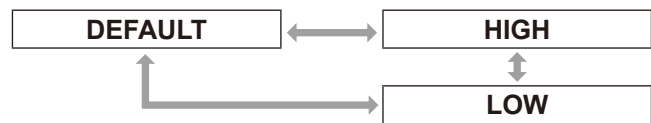

DEFAULT	Standard setting
HIGH	Adds a blue tinge to white areas in an image
LOW	Adds a red tinge to white areas in an image

PICTURE menu

ADVANCED MENU

- 1) Press ▲ ▼ to select the [ADVANCED MENU].
- 2) Press the <ENTER> button.
 - The [ADVANCED MENU] screen appears.
- 3) Press ▲ ▼ to select settings between [CONTRAST R] and [BRIGHTNESS B].
- 4) Press ▲ ▼ or the <ENTER> button.
- 5) Use ▲ ▼ to adjust the level.
 - Adjustments can be made in the range +32 (maximum) to -32 (minimum).

Adjustment	Operation	Result
CONTRAST R	Press ►.	Emphasizes red in highlight areas
	Press ◀.	Deemphasizes red in highlight areas
CONTRAST G	Press ►.	Emphasizes green in highlight areas
	Press ◀.	Deemphasizes green in highlight areas
CONTRAST B	Press ►.	Emphasizes blue in highlight areas
	Press ◀.	Deemphasizes blue in highlight areas
BRIGHTNESS R	Press ►.	Emphasizes red in shadow areas
	Press ◀.	Deemphasizes red in shadow areas
BRIGHTNESS G	Press ►.	Emphasizes green in shadow areas
	Press ◀.	Deemphasizes green in shadow areas
BRIGHTNESS B	Press ►.	Emphasizes blue in shadow areas
	Press ◀.	Deemphasizes blue in shadow areas

DAYLIGHT VIEW

This corrects images so that they appear vivid when projected under bright lighting.

- 1) Press ▲ ▼ to select [DAYLIGHT VIEW].
- 2) Press ◀▶ or the <ENTER> button.
 - The [DAYLIGHT VIEW] individual adjustment screen will be displayed.
- 3) Press ◀▶ to switch [DAYLIGHT VIEW].
 - The setting will change as follows each time you press the button.



AUTO	Automatically adjustment to suit ambient brightness
ON	Enable DAYLIGHT VIEW
OFF	Disable DAYLIGHT VIEW

Note

- You can not set [AUTO] if [REAR/DESK] or [REAR CEILING] is selected for [PROJECTION METHOD] of [PROJECTOR SETUP].
- The [AUTO] mode may not function properly if an object is placed on the top of the projector.

DIGITAL CINEMA REALITY

You can improve the vertical resolution of 2-2 and 2-3 pull-down video.

This function is available only with the following signal inputs.

(525i(480i), 625i(576i), 1125(1080)/60i, 1125(1080)/50i)

- 1) Press ▲ ▼ to select [DIGITAL CINEMA REALITY].
- 2) Press ◀▶ or the <ENTER> button.
 - The [DIGITAL CINEMA REALITY] screen appears.
- 3) Press ◀▶ to switch [DIGITAL CINEMA REALITY] settings.
 - Each press of the button switches the settings as shown below.



OFF	Disable DIGITAL CINEMA REALITY
ON	Enable DIGITAL CINEMA REALITY

NOISE REDUCTION

[Only for S-VIDEO and VIDEO signal input]

This can be used to adjust pictures if they contain interference as a result of poor quality of the input signal.

- 1) Press ▲▼ to select [NOISE REDUCTION].
- 2) Press ◀▶ or the <ENTER> button.
 - The [NOISE REDUCTION] screen will be displayed.
- 3) Press ◀▶ to switch [NOISE REDUCTION].
 - The setting will change as follows each time you press the button.



ON	Enables noise reduction
OFF	Disables noise reduction

Attention

- If [NOISE REDUCTION] is set active when the selected input signal has less noise, applying noise reduction may affect the image quality. If so, set to [OFF].

TV-SYSTEM

[Only for S-VIDEO and VIDEO signal input]

Select color system to suit input signal.

- 1) Press ▲▼ to select [TV-SYSTEM].
- 2) Press ◀▶ or the <ENTER> button.
 - The [TV-SYSTEM] screen appears.
- 3) Press ◀▶ to select system.
 - Each press of the button switches the settings as shown below.

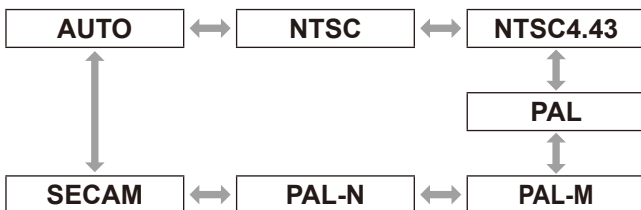

Attention

- [AUTO] mode is selected by default.
- When the projector is not working properly in [AUTO] mode, change the setting according to each SYSTEM SELECTOR type.

Note

- [AUTO] automatically selects from NTSC, NTSC4.43, PAL, PAL-M, PAL-N, SECAM, and PAL60.

RGB/YP_BP_R

[Only for RGB/YP_BP_R signals input]

Set this function to [AUTO] for normal operation.

When [AUTO] does not provide a normal picture, select [RGB] or [YP_BP_R] depending on signal input.

This function is available only with the following signal inputs. (VGA60, 525i(480i), 625i(576i), 525p(480p), 625p(576p), 1125(1080)/60i, 1125(1080)/50i, 1125(1080)/60p, 1125(1080)/50p, 1125(1080)/24p, 750(720)/60p, 750(720)/50p)

Use the steps below to select signal input to the COMPUTER, DVI-I, and HDMI terminals.

- 1) Press ▲▼ to select [RGB/YP_BP_R].
- 2) Press ◀▶ or the <ENTER> button.
 - The [RGB/YP_BP_R] screen appears.

- 3) Press ◀▶ to select.

- Each press of the button switches the settings as shown below.



AUTO	A synch signal automatically selects RGB or YP _B P _R signal
RGB	Select for RGB signal input
YP _B P _R	Select for YP _B P _R signal input

When the DVI (digital) signal is input, you can not select [AUTO]. You can select only when [RGB] or [YP_BP_R] is input.

POSITION menu

Select [POSITION] from the Main Menu (see “Navigating through the menu” on page 35), then select the item from the sub-menu.

- After selecting the item, press ▲▼◀▶ to set.

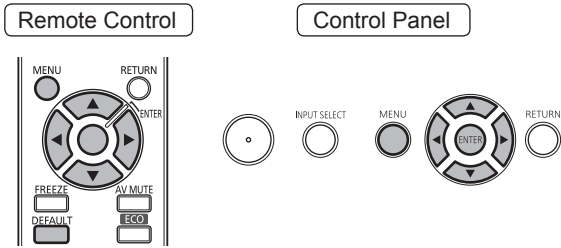

KEYSTONE

Keystone is the image distortion that occurs when the projector is aligned non-perpendicularly to the screen or the projection screen has an angled surface. Use the steps below to correct this distortion.

- 1) Press ◀▶ to select [KEYSTONE].
- 2) Press ◀▶ or the <ENTER> button.
 - The [KEYSTONE] screen appears.
- 3) Press ▲▼◀▶ to compensate.

Operation	Screen image

Note

- This function allows you to make a $\pm 30^\circ$ correction for vertical distortion. However, picture quality decreases proportional to increase in correction and the image loses focus. Make the best possible projector installation to minimize the need for keystone correction.
- Keystone correction will also change the size of the projected image.
- Some lens shift positions may also result in keystone distortion.
- Corrections and lens zoom adjustments may affect the aspect ratio of the projected image.

SHIFT

This function allows the user to adjust the raster position vertically or horizontally if the position of the image projected on the screen is displaced even when the projector is properly aligned with the screen.

- 1) Press ▲▼ to select [SHIFT].
- 2) Press the <ENTER> button.
 - The [SHIFT] screen will be displayed.
- 3) Press ▲▼◀▶ to adjust the position.

Note

- Adjustments cannot be made during network signal input.
- You can also press the ▲▼◀▶ buttons directly to adjust this function.

■ For vertical (up and down) adjustment

Operation	Adjustment
Press ▲.	The picture position moves up.
Press ▼.	The picture position moves down.

■ For horizontal (right and left) adjustment

Operation	Adjustment
Press ▶.	The picture position moves to the right.
Press ◀.	The picture position moves to the left.

SHIFT V

[This adjustment is available only when the “ASPECT” of the PT-FW430U is set to “H FIT”]

- 1) Press ▲▼ to select [SHIFT V].
- 2) Press ◀▶ or the <ENTER> button.
 - The [SHIFT V] screen appears.
- 3) Press ◀▶ to vertically adjust the image.

DOT CLOCK

[Available only for RGB (still image) signal input]

Use this function to adjust and minimize the effect of interference caused by projection of patterns consisting of vertical stripes.

The projection of the striped pattern shown below may cause cyclic patterns (noise). Use the steps below to minimize noise.

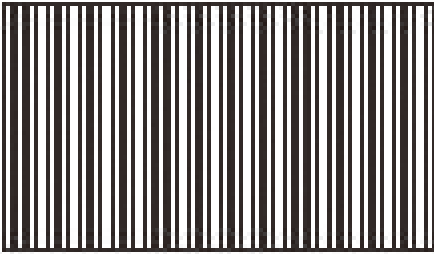

- 1) Press ▲▼ to select [DOT CLOCK].
- 2) Press ◀▶ or the <ENTER> button.
 - The [DOT CLOCK] screen appears.
- 3) Press ◀▶ to adjust.
 - Adjustments can be made between - 32 and + 32.

Attention

- Make this adjustment before [CLOCK PHASE].

CLOCK PHASE

Use this when the screen flickers or halos are observed around contours.

- 1) Press ▲▼ to select [CLOCK PHASE].
- 2) Press ◀▶ or the <ENTER> button.
 - The [CLOCK PHASE] screen will be displayed.
- 3) Press ◀▶ to adjust the level.
 - The value changes from - 16 to + 16. Adjust so that the amount of interference is at a minimum.

Note

- The CLOCK PHASE may not be adjusted, depending on the signal.
- No optimal value may be obtained if the output of the PC to which the signal input is applied is unstable.
- No optimal value may be obtained if the total number of dots is not correct.
- [CLOCK PHASE] can be adjusted only when analog signals are input to COMPUTER or DVI-I terminals.
- Adjustments cannot be made for digital signal inputs.

OVER SCAN

[Only during S-VIDEO/VIDEO/YP_BPr/RGB (Video)/ DVI (Video) and HDMI (Video) signal input]

Use the following steps to make adjustments when text and images on the periphery of the projected image are not properly displayed.

- 1) Press ▲▼ to select [OVER SCAN].
- 2) Press ◀▶ or the <ENTER> button.
 - The [OVER SCAN] screen appears.
- 3) Press ◀▶ to adjust.
 - Adjustments can be made between 0 and +3.

Note

- Adjustments cannot be made for network signal inputs.

POSITION menu

ASPECT

You can switch the horizontal and vertical ratio (aspect ratio).

- 1) Press ▲▼ to select [ASPECT].
- 2) Press ◀▶ or the <ENTER> button.
 - The [ASPECT] screen appears.
- 3) Press ◀▶ to change the setting.

PT-FW430U

The aspect ratio switches based on the input signals and the screen format setting (16:10 or 16:9).
(▶page 51)

[When S-Video/Video/YP_BP_R is input]

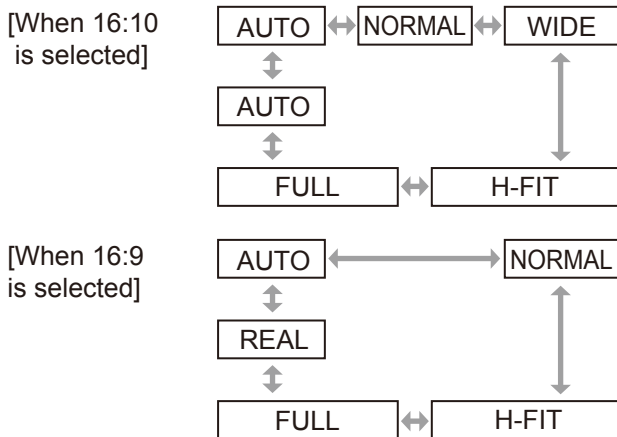

Note

- Only NTSC 525i (480i) signals are projected in AUTO mode.
- Only specific input signals are projected in REAL mode.
- When 16:9 signals are detected,
 - [When 16:10 is selected]: The aspect ratio switches from NORMAL ⇄ V-FIT ⇄ FULL ⇄ 4:3.
 - [When 16:9 is selected]: The aspect ratio does not switch.

[When COMPUTER is input]

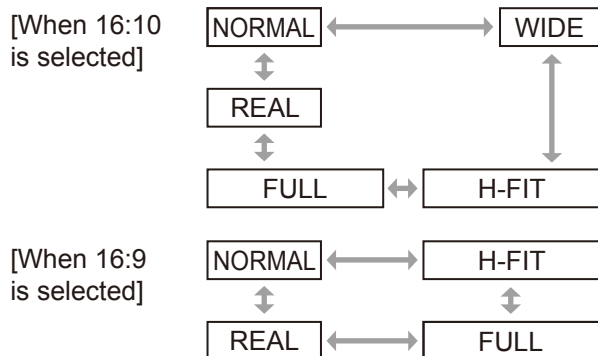

Note

- Only specific input signals are projected in REAL mode.
- When WXGA768 signals are detected,
 - [When 16:10 is selected]: The aspect ratio switches from WIDE ⇄ V-FIT ⇄ FULL ⇄ NORMAL.
 - [When 16:9 is selected]: The aspect ratio switches from NORMAL ⇄ FULL.
- When wide signals *2 other than WXGA768, WIDE720, 1125 (1080)/50p, and 1125 (1080)/60p are detected,
 - [When 16:10 is selected]: The aspect ratio switches from WIDE ⇄ NORMAL.
 - [When 16:9 is selected]: The aspect ratio switches from NORMAL ⇄ FULL.

AUTO

[Only when NTSC and 525i (480i) signals are input]

If signals contain a signal identifying the aspect ratio, the proper ratio is automatically set and the image is projected.

NORMAL

When standard *1 or 16:9 signals are input, the image is projected in the input aspect ratio. When 15:9 or 16:10 signals are input, the image is shrunk to fit the 4:3 screen while keeping the input aspect ratio.

- Input signal: XGA

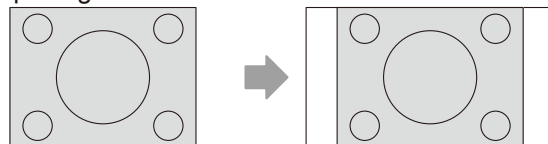

Image: Panel:

- Input signal: 1125 (1080)/60i

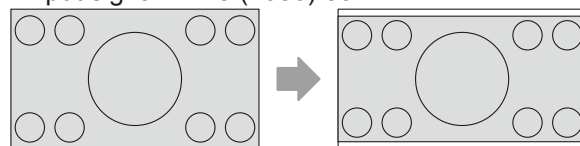

Image: Panel:

- Input signal: WXGA800

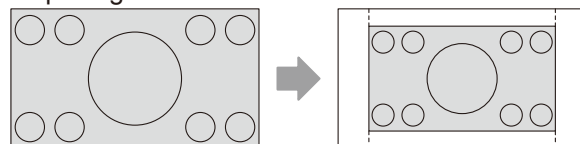

Image: Panel: Screen:

*1 : Standard signals are signals with 4:3 or 5:4 aspect ratio.

*2 : Wide signals are signals with 16:10, 16:9, or 15:9 aspect ratio.

WIDE

When standard *1 signals are input, the image is projected in the 16:9 aspect ratio.

When 15:9, 16:9 or 16:10 signals are input, the image is projected in the input aspect ratio.

- Input signal: XGA

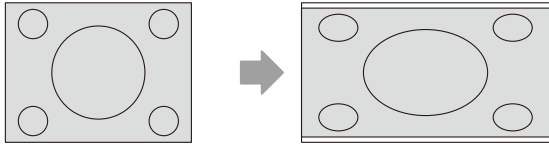

Image: Panel:

- Input signal: WXGA768

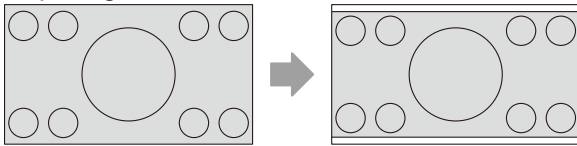

Image: Panel:

H-FIT

When standard signals *1 are input, the aspect ratio is kept fixed. The image is projected using all the panel pixels horizontally, and the vertical edges of the image are cropped.

- Input signal: XGA

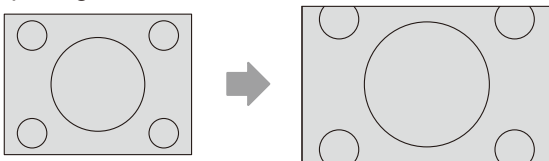

Image:

V-FIT

When 16:9 signals are input, the aspect ratio is kept fixed. The image is projected using all the panel pixels vertically, and the horizontal edges of the image are cropped.

- Input signal: 1125 (1080)/60i

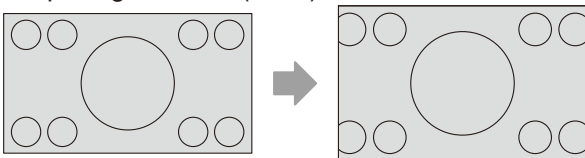

Image:

FULL

The image is projected using all the panel (screen) pixels. The input signals are converted to the aspect ratio of the panel (screen).

- Input signal: XGA

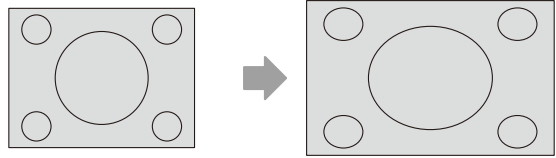

Image:

- Input signal: 1125 (1080)/60i

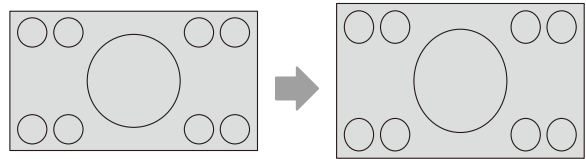

Image:

REAL

The image is projected without size adjustment, keeping the resolution of the input signals.

- Input signal: XGA

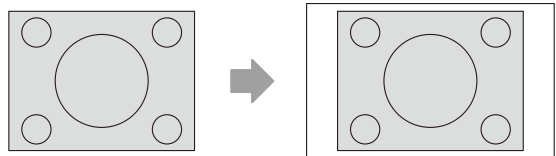

Image: Panel:

Attention

- When an image of 4:3 aspect ratio is projected in the 16:9 ratio, the edges of the image may become invisible or distorted. It is recommended to select the 4:3 aspect ratio to respect the intention of the image creator.

Note

- If you select an aspect ratio different from the input signals, the image displayed will be different from the original image.
- When used for commercial use or public viewing (in a coffee shop, hotel, etc.), stretching or shrinking a copyright-protected image using the aspect ratio function of this projector may infringe on the copyrights.
- When S Video, Video, or YP_BPR signals are input, AUTO may not appear due to the properties of the signals.

*1 : Standard signals are signals with 4:3 or 5:4 aspect ratio.

POSITION menu

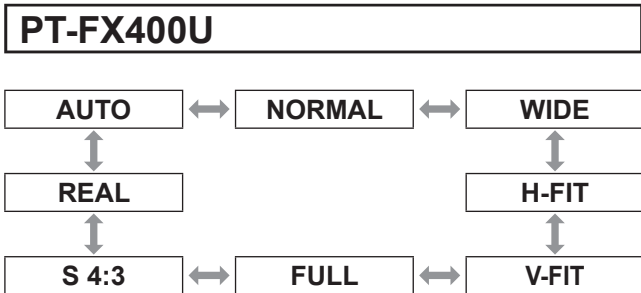

Note

- AUTO appears only during NTSC or 480i input.
- Only specific input signals are projected in REAL mode.
- When wide signals *2 are input, the aspect ratio switches from NORMAL ⇄ V-FIT ⇄ FULL.

AUTO

[Only when NTSC and 525i (480i) signals are input]

If signals contain a signal identifying the aspect ratio, the proper ratio is automatically set and the image is projected.

NORMAL

When standard signals *1 or wide signals *2 are input, the image is projected keeping the input aspect ratio.

- Input signal: XGA

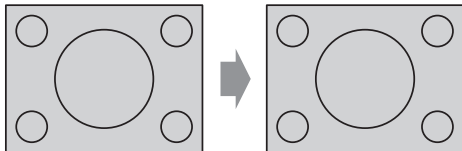

Image:

- Input signal: 1125 (1080)/60i

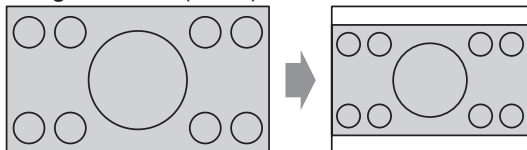

Image:

WIDE

When standard signals *1 are input, the image is projected with the aspect ratio converted to 16:9.

- Input signal: XGA

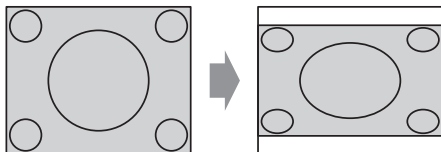

Image:

H-FIT

When standard signals *1 are input, the aspect ratio is kept fixed. The image is projected using all the panel pixels horizontally, and the vertical edges of the image are cropped.

- Input signal: SXGA

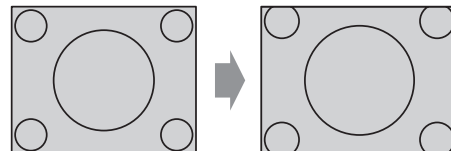

Image:

V-FIT

When wide signals *2 are input, the aspect ratio is kept fixed. The image is projected using all the panel pixels vertically, and the horizontal edges of the image are cropped.

- Input signal: 1125 (1080)/60i

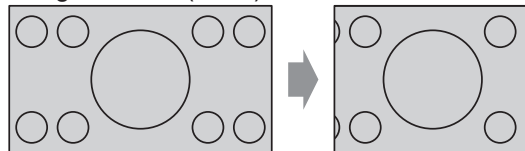

Image:

FULL

The image is projected using all the panel (screen) pixels. The input signal are converted to the aspect ratio of the panel (screen).

- Input signal: 1125 (1080)/60i

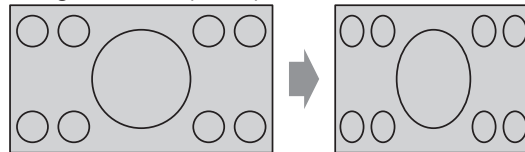

Image:

S4:3

When standard signals *1 are input, the image is projected with the signal size compressed down to 75%. (Convenient for projecting an image of 4:3 aspect ratio to a screen of 16:9).

- Input signal: XGA

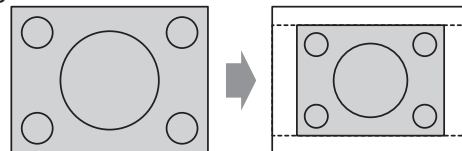

Image: Panel: Screen:

*1 : Standard signals are signals with 4:3 or 5:4 aspect ratio.

*2 : Wide signals are signals with 16:10, 16:9, or 15:9 aspect ratio.

REAL

The image is projected without size adjustment, keeping the resolution of the input signals. Settable when the input signals are smaller than the number of the pixels of the projector's LCD (1024 x 768).

- Input signal: NTSC

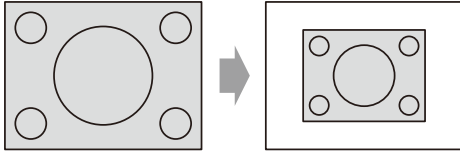

Image: Panel:

Attention

- When an image of 4:3 aspect ratio is projected in the 16:9 ratio, the edges of the image may become invisible or distorted. It is recommended to select the 4:3 aspect ratio to respect the intention of the image creator.

Note

- If you select an aspect ratio different from the input signals, the image displayed will be different from the original image.
- When used for commercial use or public viewing (in a coffee shop, hotel, etc.), stretching or shrinking a copyright-protected image using the aspect ratio function of this projector may infringe on the copyrights.

FRAME LOCK

[Only for RGB/DVI (analog) and HDMI signals input]

Settable for specific computer signals. Set when the movie is distorted.

1) Select [FRAME LOCK] using the ▲ ▼ buttons.

2) Press ◀▶ or the <ENTER> button.
• The [FRAME LOCK] screen appears.

3) Press ◀▶ to set [FRAME LOCK].



On	Enable FRAME LOCK
Off	Disable FRAME LOCK

LANGUAGE

Select [LANGUAGE] from the Main Menu (see “Navigating through the menu” on page 35), then select the item from the sub-menu.

- Use the ▲ ▼ buttons to select a language and press the <ENTER> button to complete it.

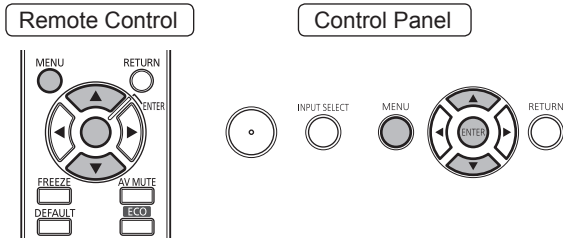

Changing the display language

This lets you switch the on-screen display language.

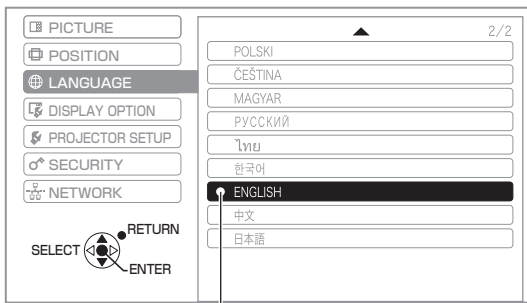
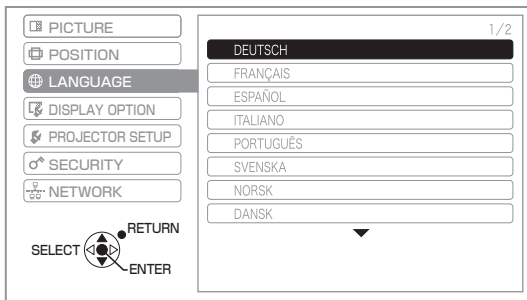

Displayed in a chosen language

- Menus, setting items, adjustment screens, and control button names will be displayed in the language the user chooses.
- On-screen display is available in the following languages: German, French, Spanish, Italian, Portuguese, Swedish, Norwegian, Danish, Polish, Czech, Hungarian, Russian, Thai, Korean, English, Chinese and Japanese.

DISPLAY OPTION menu

Select [DISPLAY OPTION] from the Main Menu (see “Navigating through the menu” on page 35), then select the item from the sub-menu.

- After selecting the item, press ◀▶ to set.

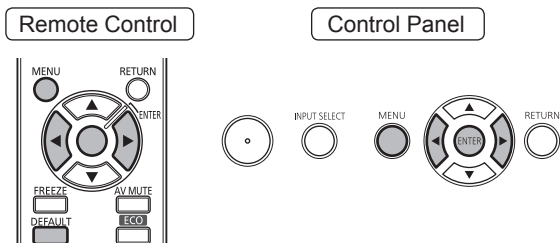

ON-SCREEN DISPLAY

You can set the on screen display.

- 1) Press ▲▼ to select [ON SCREEN DISPLAY].
- 2) Press the <ENTER> button.
 - The [ON SCREEN DISPLAY] screen appears.
- 3) Press ▲▼ to select items and ◀▶ to switch settings.

INPUT GUIDE

You can set the display method of the name of the input terminal currently selected.

- Each press of the button switches the settings as shown below.



DETAILED	Displays the input terminal graphically
OFF	Disables INPUT GUIDE
SIMPLE	Displays the name of input terminal

Note

- While set to [DETAILED], if signals are not input to COMPUTER/DVI-I/HDMI, “computer connection guidance” appears when connection with a computer is made. To disable computer connection guidance, select [SIMPLE] or [OFF].
- When [DETAILED] is selected, the [NETWORK] field shows the current network number of the wireless LAN *1, the projector name and ID.

*1 : Only when the optional wireless module is installed.

Computer Connection Guidance

Please refer to the below table for key commands on the computer for switching the image output.

Manufacturers	Key command to switch the image
Panasonic NEC	Fn + F3
SAMSUNG HP	Fn + F4
acer SHARP TOSHIBA	Fn + F5
lenovo LG SONY	Fn + F7
DELL EPSON	Fn + F8
FUJITSU	Fn + F10
Apple	F7

Note

- The key commands vary depending on the model of the computer. Please refer to the instruction manual supplied with the computer.

OSD DESIGN

Sets the background of the ON SCREEN DISPLAY (OSD).

- Each press of the button switches the settings as shown below.



TYPE 1	Sets the background color to semitransparent black
TYPE 2	Sets the background color to blue
TYPE 3	Set the background color to semitransparent navy

WARNING MESSAGE

Set to display/hide the WARNING MESSAGE

- Each press of the button switches the settings as shown below.



ON	Displays the WARNING MESSAGE
OFF	Hides the WARNING MESSAGE

DISPLAY OPTION menu

DVI-I IN

Change this setting if the image is not displayed properly while signals from an external device are input to the DVI-I terminal of the projector.

- 1) Press **▲ ▼** to select **[DVI-I IN]**.
- 2) Press the **<ENTER>** button.
 - The **[DVI-I IN]** screen will be displayed.
- 3) Press **▲ ▼** to select items and **◀ ▶** to switch settings.

DIGITAL/ANALOG

- Each press of the button switches the settings as shown below.

DIGITAL	↔	ANALOG
DIGITAL	Select this when a digital signal is input.	
ANALOG	Select this when an analog signal is input.	

DVI EDID

- Each press of the button switches the settings as shown below.

EDID1	↔	EDID2 (PC)
EDID1	Select this when an external device (DVD player, etc.) for outputting video signals of a moving image system is connected to DVI-I IN terminal.	
EDID2 (PC)	Select this when an external device (PC, etc.) for outputting video signals of a still image system is connected to DVI-I IN terminal.	

DVI SIGNAL LEVEL

- Each press of the button switches the settings as shown below.

0-255 : PC	↔	16-235
0-255 : PC	Select this when the digital output from an external device, such as a computer, is connected to the DVI-I IN terminal, or in similar cases.	
16-235	Select this when the output from the HDMI terminal of an external device, such as a DVD player, is connected to the DVI-I IN terminal via a conversion cable, or in similar cases.	

Note

- The optimal setting differs depending on the output setting of the connected external device. Refer to the instruction manual of the external device.
- If the setting is changed, the data for plug and play changes. For the plug and play compatible resolutions, refer to "List of compatible signals" (▶ page 83).

HDMI IN

Change this setting if video does not display normally when the projector and an external device are connected via HDMI.

- 1) Press **▲ ▼** to select **[HDMI IN]**.
- 2) Press the **<ENTER>** button.
 - The **[HDMI IN]** screen will be displayed.
- 3) Press **◀ ▶** to switch **[HDMI SIGNAL LEVEL]**.
 - Each press of the button switches the settings as shown below.

0-1023	↔	64-940
0-1023	Select this when, for example, a DVI terminal output of an external device (PC etc.) is connected to HDMI IN using a conversion cable, etc.	
64-940	Select this when, for example, an HDMI terminal output of an external device (DVD player, etc.) is connected to HDMI IN.	

Note

- The optimal setting differs depending on the output setting of the connected external device. Refer to the instruction manual for the external device.
- The displayed HDMI signal level is the value when the input is 30 bit.

CLOSED CAPTION SETTING

[Only for NTSC, 525i (480i) input]
Set the closed caption display as follows.

- 1) Press **▲▼** to select **[CLOSED CAPTION SETTING]**.
- 2) Press the **<ENTER>** button.
 - The [CLOSED CAPTION SETTING] screen is displayed.
- 3) Press **▲▼** to select, and press **◀▶** to switch.

■ CLOSED CAPTION

Displays or hides the closed caption.

- Each press of the button switches the settings as shown below.
- When you set the function to [ON], a message, [If the input matches the CC type selected, the SECURITY TEXT/LOGO will not be displayed], is displayed on the screen. Select [OK] or [CANCEL], and press the **<ENTER>** button.



OFF	Turns off closed caption display
ON	Turns on closed caption display

■ MODE

Selects a closed caption mode.

- Each press of the button switches the settings as shown below.

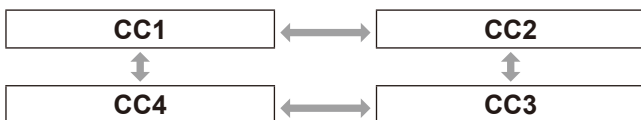

CC1	Displays CC1 data
CC2	Displays CC2 data
CC3	Displays CC3 data
CC4	Displays CC4 data

Note

- The closed caption is mainly used in the north America. This function shows the text information contained in the image signal. Captions may not be displayed on some devices or software.
- You can select [CLOSED CAPTION] only when NTSC or 525i (480i) signals are input.
- Security messages (security texts and user logo) are not displayed when the closed caption signal of the selected mode is input. (➔page 65)
- Part of characters may not be displayed when high compensation values are set in [KEYSTONE].
- Closed captions are not displayed while the menu screen appears.

SCREEN SETTING

[PT-FW430U only]

When the projection image aspect ratio is changed, the projector makes corrections to ensure the optimal images for the set screen size.

Set this in accordance with the screen you are using.

- 1) Press **▲▼** to select **[SCREEN SETTING]**.
- 2) Press the **<ENTER>** button.
 - The [SCREEN SETTING] screen will be displayed.
- 3) Press **▲▼** to select items and **◀▶** to switch settings.

■ SCREEN FORMAT

- Each press of the button switches the settings as shown below.



16:9	For screens with a 16:9 aspect ratio
16:10	For screens with a 16:10 aspect ratio

■ SCREEN POSITION

- Each press of the button switches the settings as shown below.



LOW	Displays the projected image in the lower part of the screen
CENTER	Displays the projected image in the center part of the screen
HIGH	Displays the projected image in the top part of the screen

Note

- [SCREEN POSITION] cannot be adjusted when [16:10] is selected for [SCREEN FORMAT].

DISPLAY OPTION menu

STARTUP LOGO

Sets the logo that is projected when the power is turned on.

- 1) Press ▲▼ to select [STARTUP LOGO].
- 2) Press ◀▶ to switch [STARTUP LOGO]
 - The setting changes as follows each time the button is pressed.

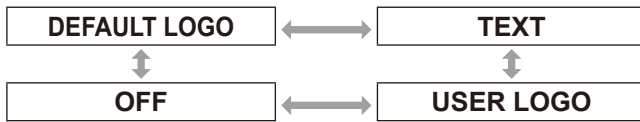

DEFAULT LOGO	The Panasonic logo is projected
TEXT	The input text is projected
USER LOGO	The logo transferred by "Logo Transfer Software *1" is projected
OFF	No startup logo is projected

*1 : "Logo Transfer Software" is included on the supplied CD-ROM.

Note

- When [TEXT] is selected, input text is projected. You can input up to two lines with 40 characters in each line.
- The STARTUP LOGO disappears after 30 seconds.

Editing text

- 1) Press ◀▶ to select [TEXT], then press the <ENTER> button.
 - The [STARTUP LOGO] screen appears.
- 2) Press ▲▼ to select the item
 - Input text to be displayed on the first line in [TEXT 1] and text for the second line in [TEXT 2].

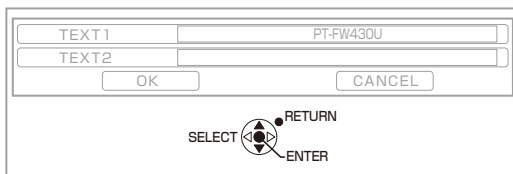

- 3) Press the <ENTER> button.
 - The [TEXT CHANGE] screen appears.

- 4) To input a character, press ▲▼◀▶ to select the character, then press the <ENTER> button.

- If you select [ALL DELETE], you can erase all the input text. If you press the [DEFAULT] button of the remote controller, you can erase the character currently selected by the cursor in the input box.

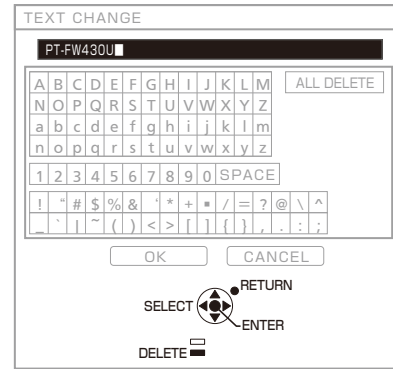

- 5) Select [OK], then press the <ENTER> button.

- 6) On the [STARTUP LOGO] screen, select [OK], then press the <ENTER> button.

- To cancel text input, select [CANCEL].

AUTO SETUP

Set this to [AUTO] under normal circumstances.

- 1) Press ▲▼ to select [AUTO SETUP].
- 2) Press ◀▶ to switch [AUTO SETUP].
 - The setting changes as follows each time the button is pressed.



AUTO	Adjusts the projected image position automatically when the projected signals are switched to the COMPUTER signals.
BUTTON	Adjusts the projected image position only when the [AUTO SETUP] button is pressed. (▶page 33)

SIGNAL SEARCH

When the power is turned on, this function automatically detects the terminal to which signals are input and sets the projection settings.

1) Press ▲▼ to select [SIGNAL SEARCH].

2) Press ◀▶ to switch [SIGNAL SEARCH].

- The setting changes as follows each time the button is pressed.



ON	Enables automatic input detection.
OFF	Disables automatic input detection.

Note

- When the AUTO SETUP button on the remote control is pressed and no projecting signal is input, SIGNAL SEARCH is enabled.

BACK COLOR

Sets the color of the projection screen when no signal is input.

1) Press ▲▼ to select [BACK COLOR].

2) Press ◀▶ to switch [BACK COLOR].

- The setting changes as follows each time the button is pressed.

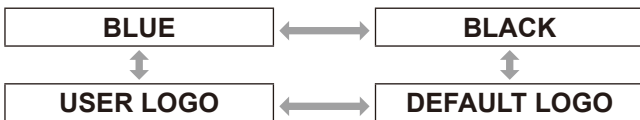

BLUE	The entire projection area appears blue.
BLACK	The entire projection area appears black.
DEFAULT LOGO	The Panasonic logo is projected.
USER LOGO	The logo transferred by "Logo Transfer Software *1" is projected.

*1 : "Logo Transfer Software" is included on the supplied CD-ROM.

WIDE MODE

This function is used when WXGA, WXGA+, WXSGA+, or WUXGA signals are input.

1) Press ▲▼ to select [WIDE MODE].

2) Press ◀▶ to switch [WIDE MODE].

- The setting changes as follows each time the button is pressed.



AUTO	Switches the setting automatically.
OFF	When inputting 4:3 signals
ON	When inputting wide signals

SXGA MODE

This function is used when the projected image of SXGA signal extends outside of the screen.

1) Press ▲▼ to select [SXGA MODE].

2) Press ◀▶ to switch [SXGA MODE].

- The setting changes as follows each time the button is pressed.



SXGA	Normal setting
SXGA +	Set this when the edge of the image is cropped

DISPLAY OPTION menu

OTHER FUNCTIONS

AUTO SETUP

See "Adjusting the display position automatically". (➔page 33)

FREEZE

You can pause the projection and mute the sound temporarily, regardless of the playing status of the connected device.

Pressing the <RETURN> button cancels the function.

AV MUTE

You can stop the projection and the sound when you will not be using the projector for a while.

Pressing the <RETURN> button cancels the function.

INDEX WINDOW

You can capture the projected image and store it to memory as a still image. You can also project the still image and movie simultaneously in split-window display.

Pressing the <RETURN> button cancels the function.

The projected image at the time you press INDEX WINDOW is captured as a still image.

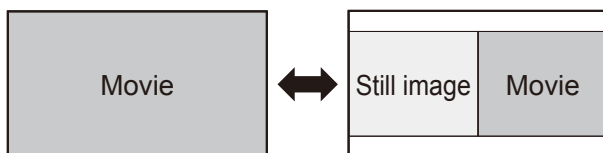

Button function while INDEX WINDOW is displayed

Press the ▲▼ buttons to set the window size
(The size of the window can be set in three ways for the PT-FX400U, and two ways for the PT-FW430U.)

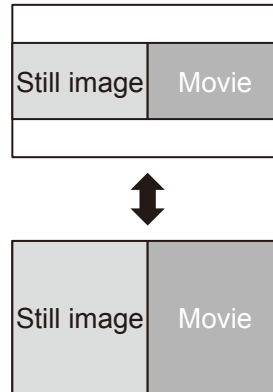

Press the ◀▶ buttons to switch the positions of the still image and movie right or left.

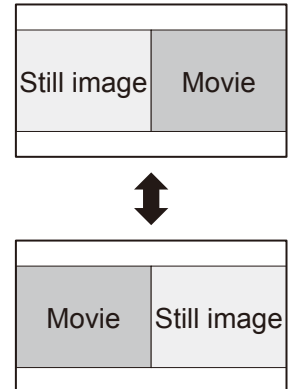

Note

- The aspect ratio is adjusted. Consequently, the image is stretched vertically.
- If you change the size of window, the aspect ratio is adjusted. (➔page 44)
- Press the <ENTER> button to capture a new still image.
- When you capture from a movie with quick motion, the still image may be distorted.
- When you set the aspect ratio to [REAL], the image may not be stretched vertically depending on the property of the signals.

DIGITAL ZOOM

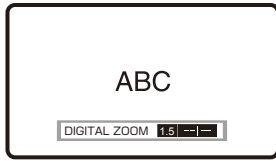

You can enlarge the center area.
You can also change the location of the area to be enlarged.
Pressing the <RETURN> button cancels the function.

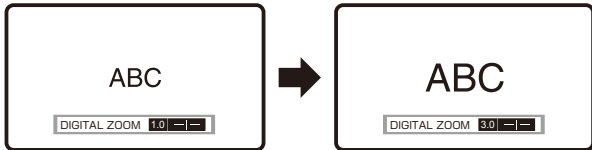

Button functions during DIGITAL ZOOM

Pressing the ► button increases magnification
Pressing the ◀ button decreases magnification

◀ button ←————→ ► button



After setting the magnification, press the <ENTER> button.

Pressing the ▲▼ buttons moves the area to the top or the bottom.
Pressing the ◀▶ buttons moves the area to the left or the right.

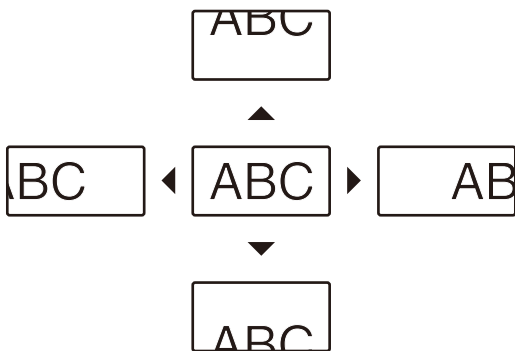

Note

- Magnification can be set from 1.0x to 2.0x in 0.1 increments. When [FRAME LOCK] in the [POSITION] menu is set to [OFF], you can also adjust the magnification from 1.0x to 3.0x. When the setting mentioned above is [ON], you can adjust the magnification from 1.0x to 2.0x.
- When the input signals change during DIGITAL ZOOM, the DIGITAL ZOOM function will be cancelled.
- When DIGITAL ZOOM is active, the FREEZE function is not available.

SIDE BY SIDE

[PT-FW430U only]

Two different input signals can be simultaneously projected.
Pressing the <RETURN> button cancels the function.

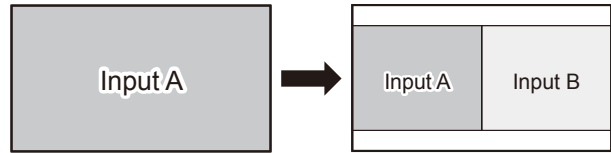

Button functions during a SIDE BY SIDE projection

When you press ▲▼, the list of available input sources is displayed.
Press ▲▼ to select the image to show on the right side of the screen (Input B) against the left side of the screen (Input A), and press the <ENTER> button.

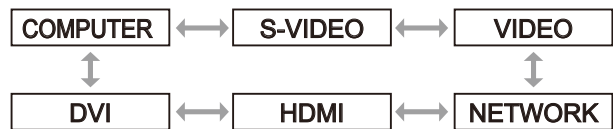

*: The input will be skipped if it cannot be switched to.

Note

- You can cancel the SIDE BY SIDE function pressing the <MENU>, <RETURN>, <DVI-I>, <VIDEO/S VIDEO>, <NETWORK>, or <HDMI> button.
- [FREEZE] and [VOLUME] are set to the Input A.
- While the SIDE BY SIDE function is activated, [AUTO SETUP], [INDEX WINDOW], and [DIGITAL ZOOM] are not available.
- While the SIDE BY SIDE function is activated, you can not adjust or set the MENU items.
- [PICTURE] settings can be set individually for Input A and Input B. (The value of [DAYLIGHT VIEW] for Input A is applied to both inputs.)
- The aspect ratio selected in the ASPECT menu is maintained during a SIDE BY SIDE projection, except for COMPUTER signals and NETWORK signals.
- Depending on the combination of input signals, SIDE BY SIDE projection may not be available.
- For details, see "Two window display combination list" (➔page 82).

PROJECTOR SETUP menu

Select [PROJECTOR SETUP] from the Main Menu (see “Navigating through the menu” on page 35), then select the item from the sub-menu.

- After selecting the item, press ◀▶ ▲▼ to set.

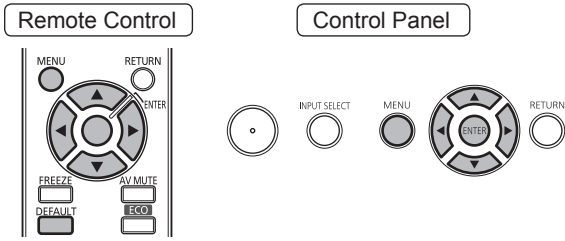

STATUS

Displays the status of the projector.

- 1) Press ▲▼ to select [STATUS].
- 2) Press the <ENTER> button.
 - The [STATUS] screen appears.

SIGNAL NAME	Displays the input signal name.
SIGNAL FREQUENCY	Displays the frequency of the input signal.
PROJECTOR RUNTIME	Displays the projector runtime.
LAMP	Indicates the number of hours the lamp has been used
SERIAL NUMBER	Displays the serial number of the projector.

PROJECTOR ID

The projector has an ID number setting function that helps the user to control two or more projectors either simultaneously or separately with a single remote control.

- 1) Press ▲▼ to select [PROJECTOR ID].
- 2) Press the <ENTER> button.
 - The [PROJECTOR ID] screen appears.
- 3) Press ▲▼ to select [PROJECTOR ID].
 - Select [ALL] or a number between [1] and [6] from the list that appears.

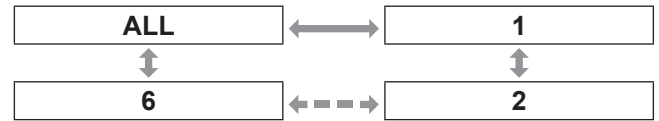

- 4) Press the <ENTER> button to confirm the entry.
 - The selected [PROJECTOR ID] appears.

Note

- If the projectors are given ID numbers, their remote controls must be assigned the same ID numbers, respectively.
- If the ID number of a projector is set to [ALL], it can be controlled by the remote control or the PC with any ID number. If multiple projectors are used and some of them have their IDs set to [ALL], they cannot be controlled separately from the projectors with other ID numbers. For details on remote control ID setting, refer to “Setting Remote control ID numbers” (▶ page 20).

INITIAL START UP

Use the steps below to select INITIAL START UP when the projector is connected to a wall outlet.

- 1) Press ▲▼ to select [INITIAL START UP].
- 2) Use ◀▶ to switch [INITIAL START UP] settings.
 - Each press of the button switches the settings as shown below.



LAST MEMORY	Starts up the projector in the mode it was in when last shut down
STANDBY	Starts up in standby mode
ON	Starts projection immediately

PROJECTION METHOD

A projection scheme can be chosen depending on the installation of the projector. If the picture is shown upside down or in reverse, change the projection method.

1) Press ▲▼ to select [PROJECTION METHOD].

2) Press ◀▶ to switch [PROJECTION METHOD].

- Each press of the button switches the settings as shown below.

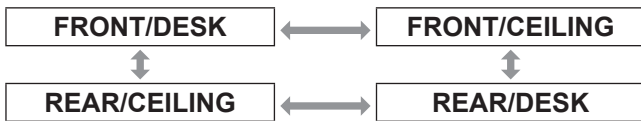

FRONT/DESK	When mounted on a desk or stand in front of the screen
FRONT/CEILING	When mounted to the ceiling using ceiling mount brackets (optional accessory) in front of the screen.
REAR/DESK	When mounted on a desk or stand behind the screen (when using a translucent screen)
REAR/CEILING	When mounted to the ceiling using ceiling mount brackets (optional accessory) behind the screen (when using a translucent screen)

HIGH ALTITUDE MODE

If you use the projector at elevations (1 400 m (4593 ft) to 2 700 m (8858 ft)), the [HIGH ALTITUDE MODE] setting needs to be [ON].

1) Press ▲▼ to select [HIGH ALTITUDE MODE].

2) Press ◀▶ to switch [HIGH ALTITUDE MODE].

- Each press of the button switches the settings as shown below.



OFF	Select this when using in normal environment (lower than 1 400 m (4593 ft) above sea level)
ON	Select this when using at high altitude (1400 m (4593 ft) or higher and lower than 2700 m (8858 ft) above sea level)

Note

- Make sure to set this to [OFF] when you use the projector at elevations lower than 1400 m (4593 ft) above sea level. Set this to [ON] when you use the projector at elevations of 1400 m (4593 ft) or higher and lower than 2700 m (8858 ft). Failure to observe this may result in shortening of the life of units or malfunction of the projector.
- Do not install the projector at elevations of 2700 m (8858 ft) or higher. Doing so may result in shortening of the life of units or malfunction of the projector.
- The loudness of fan noise depends on the [HIGH ALTITUDE MODE] setting.

LAMP POWER

Can switch the electric power of projector lamp. Set the lamp power to meet the environment and purpose of projection.

1) Press ▲▼ to select [LAMP POWER].

2) Press ◀▶ to switch [LAMP POWER].

- The setting will change as follows each time the button is pressed.



NORMAL	When high brightness is needed
ECO	When high brightness is not needed

Note

- The [ECO] mode can reduce power consumption and operation noise.
- The selection made here is reflected to the indication of set ECO level in the "Multi Projector Monitoring & Control Software" installed from the supplied CD-ROM.

PROJECTOR SETUP menu

SCHEDULE

This sets the command execution schedule for each day of the week.

How to enable the SCHEDULE function

- 1) Press ▲▼ to select [SCHEDULE].
- 2) Press ◀▶ to switch [SCHEDULE].
 - Each press of the button switches the settings as shown below.

ON	↔	OFF
ON		Enables set SCHEDULE
OFF		Disable set SCHEDULE

Note

- If [SCHEDULE] is set to [ON], the setting for [STANDBY MODE] is automatically set to [NORMAL] and cannot be changed. Even if [SCHEDULE] is then set to [OFF] when in this state, the setting of [STANDBY MODE] remains at [NORMAL].

How to assign a program

- 1) With [SCHEDULE] switched to [ON], press <ENTER> button.
 - The [SCHEDULE] screen will be displayed.
- 2) Select and assign program to each day of week.
 - Press ▲▼ to select a day of week and press ◀▶ to select a program number.
 - You can set the program from No.1 to No.7. “- -” indicates that the program number has not been set yet.

How to set a program

You can set up to 16 commands to each program.

- 1) On the [SCHEDULE] screen, press ▲▼ to select [PROGRAM EDIT].
- 2) Press ◀▶ to select a program number to be set (Program 1 to Program 7) and press the <ENTER> button.
- 3) Press ▲▼ to select a command number (01 to 16) and press the <ENTER> button.
 - You can change the page using ▲▼.
- 4) Press ▲▼ to select [TIME] or [COMMAND] and change the setting according to the instructions of the menu.
 - Press the <ENTER> button after selecting the [COMMAND], and you can set detailed settings.

TIME	Set the time at which the command will be executed using ▲▼ buttons.
COMMAND	Select a command to execute at the set time from the following. <ul style="list-style-type: none"> • POWER ON • STANDBY • AV MUTE ON • AV MUTE OFF • INPUT COMPUTER • INPUT VIDEO • INPUT S-VIDEO • INPUT DVI-I • INPUT HDMI • INPUT NETWORK • LAMP POWER NORMAL • LAMP POWER ECO • SIDE BY SIDE MODE OFF*1 • SIDE BY SIDE MODE ON*1 • IN STANDBY MODE (AUDIO) ON • IN STANDBY MODE (AUDIO) OFF • VOLUME

*1 : PT-FW430U only

- 5) Press ▲▼ to select [STORE] and press the <ENTER> button.

Note

- If you try to register a setting that would cause the lamp to flash for a short time, an error message will be displayed on the screen. Set the [TIME] and [COMMAND] again.
- If multiple commands have been set for the same time, they are executed in chronological order starting from the smallest command number.
- The setting time operates under the local time. (➔page 62)
- If an operation is executed with the remote control or control panel of the projector or with a control command before the command set in the schedule is executed, the command set with this function may not be executed.

ECO MANAGEMENT

Can optimize lamp power and reduce the power consumption according to the application.

- 1) Press ▲▼ to select [ECO MANAGEMENT].
- 2) Press the <ENTER> button.
 - The [ECO MANAGEMENT] screen is displayed.
- 3) Press ▲▼ to select the item and press ◀▶ to switch the setting.

■ AUTO POWER SAVE

[AMBIENT LIGHT DETECTION], [SIGNAL DETECTION], and [AV MUTE DETECTION] functions can be used.

Note

- Not available when [LAMP POWER] is set to [ECO].

1. Select [AUTO POWER SAVE] in Step 3.
2. Press ◀▶ to switch ON (Enable) / OFF (Disable) of the [AUTO POWER SAVE] setting.
 - The setting will change as follows each time the button is pressed.



ON	Enables AUTO POWER SAVE
OFF	Disables AUTO POWER SAVE

3. Press ▲▼ to select [AUTO POWER SAVE] conditions.

AMBIENT LIGHT DETECTION	Adjusts the lamp power according to the ambient brightness.
SIGNAL DETECTION	Drops the lamp power when no signal is input.
AV MUTE DETECTION	Drops the lamp power in the AV Mute mode.

4. Press ◀▶ to switch ON (Enable) / OFF (Disable) of the selected condition.
 - The setting will change as follows each time the button is pressed



ON	Enables the setting
OFF	Disables the setting

Note

- In following cases, [LAMP POWER] does not drop automatically.
 - When [LAMP POWER] is [ECO].
 - Immediately after the lamp is turned on or immediately after setting [LAMP POWER]
- When [ECO MANAGEMENT] is [OFF], you cannot set [AMBIENT LIGHT DETECTION], [SIGNAL DETECTION], and [AV MUTE DETECTION] linked.
- The selection made here is reflected to the indication of set ECO level in the "Multi Projector Monitoring & Control Software" installed from the supplied CD-ROM.

■ NO SIGNAL SHUT-OFF

If no signal is input within a preset time, the projector power is automatically switched to the standby state.



DISABLE	Disables NO SIGNAL SHUT-OFF
15 MIN. - 60 MIN.	Allows you to set a time in 5 minute increments after which the projector will automatically shut down if there is no signal

Note

- The selection made here is reflected to the indication of set ECO level in the "Multi Projector Monitoring & Control Software" installed from the supplied CD-ROM.
- The duration is set to 30 minutes under factory default settings and after you perform [INITIALIZE ALL].

■ STANDBY MODE

This function can set the electric power when the projector is standing by.



NORMAL	Does not restrict functionality even in standby mode
ECO	Restricts some functions in standby mode to reduce power consumption

Note

- If STANDBY MODE is set to [ECO], you cannot use network functions when the projector is standing by. Also, you cannot use some RS-232C protocol commands. When you turn the POWER switch [ON], display of the initial image may be delayed for approximately 10 seconds when compared with [NORMAL] mode operation.
- If set to [NORMAL], you can use network functions when the projector is standing by.

PROJECTOR SETUP menu

EMULATE

When using the control commands for one of our projectors that you have previously purchased to control this projector using a computer via its serial input terminal, set up the EMULATE function as follows. This will allow you to use the control software etc. designed for our existing projectors.

- 1) Press ▲ ▼ to select [EMULATE].
- 2) Press the <ENTER> button.
 - The [EMULATE] screen appears.
- 3) Press ▲ ▼ to select the required item.
- 4) Press the <ENTER> button.

Note

- Refer to "Serial terminal" (➔ page 77).

DEFAULT	FX400 Series, FW430 Series, F100 Series, FW100 Series, F200 Series, F300 Series, FW300 Series
D3500	D3500 Series
D4000	D4000 Series
D/W5k	D5500 Series, DW5000 Series, D5600 Series, DW5100 Series, D5700 Series
D/W/Z6k	D5000 Series, D6000 Series, DW6300 Series, DZ6700 Series, DZ6710 Series, DZ570 Series, DW530 Series, DX500 Series
L730	L520 Series, L720 Series, L730 Series
L780	L750 Series, L780 Series
L735	L735 Series
L785	L785 Series
LB/W	LB2 Series, LB1 Series, LB75 Series, LB80 Series, LB90 Series, ST10 Series, LB3 Series, LW80NT Series

FUNCTION BUTTON

Three function buttons (<FUNC 1> to <FUNC 3>) on the remote control can be assigned to any frequent operations. They can be used as a useful shortcut button.

■ To assign functions to the <FUNC1> to <FUNC3> buttons

- 1) Press <MENU> button on the remote control or the projector to select a menu option (Main Menu, Sub-menu or Advanced Menu).
 - For the on-screen menu selection, see "Navigating through the menu". (➔ page 35)

- 2) Hold down any of the <FUNC 1> to <FUNC 3> buttons on the remote control more than 3 seconds.

■ To cancel functions assigned to the <FUNC1> to <FUNC3> buttons

- 1) Press ▲ ▼ to select [FUNCTION].
- 2) Press the <ENTER> button.
- 3) Press ▲ ▼ to select [CANCEL] for the function button (<FUNC1> to <FUNC3>) assigned with the function.
- 4) Press the <ENTER> button.
- 5) When the confirmation screen appears, press ◀▶ to select [OK], then press the <ENTER> button.

Note

- When the setting is complete, the following indicators will appear to the left of the assigned menu item (Main menu, Sub-menu, or Advanced menu): F1 for <FUNC1>, F2 for <FUNC2>, and F3 for <FUNC3>.

AUDIO SETTING

Set details of Audio functions.

- 1) Press ▲▼ to select [AUDIO SETTING].
- 2) Press the <ENTER> button.
 - [AUDIO SETTING] screen will be displayed.
- 3) Use ▲▼ to select an item and use ◀▶ to adjust the level or switch settings.

VOLUME

You can adjust the volume of the projector's speaker or audio output.

Operation	Adjustment	Adjustment range
Press ►	Increases volume	Max. 63
Press ◀	Decreases volume	Min. 0

BALANCE

You can adjust the balance of left/right audio output.

Operation	Adjustment	Adjustment range
Press ►	Increases the volume from the right	L 16 to R 16
Press ◀	Increase the volume from the left	

IN STANDBY MODE

You can set the sound output in standby mode.

- Each press of the button switches the settings as shown below.



OFF	Disables sound output during standby
ON	Enables sound output during standby

Note

- You cannot enable sound output during standby if [STANDBY MODE] of [ECO MANAGEMENT] is set [ECO].

POWER BUTTON BEEP

You can turn on and off the beep sound produced by the POWER button.

- Each press of the button switches the settings as shown below.



OFF	The POWER button does not beep when pressed
ON	The POWER button beeps when pressed

AUDIO IN SELECT

A sound input terminal of [AUDIO IN 1], [AUDIO IN 2], [AUDIO IN 3], [HDMI AUDIO IN] and [NETWORK AUDIO IN] can be selected.

- The setting will change as follows each time the button is pressed.

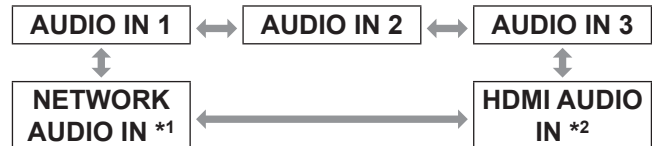

*1 : When only a NETWORK input terminal is provided

*2 : When only an HDMI input terminal is provided

AUDIO IN 1	Sound is output from AUDIO IN 1 terminal when video of preset input terminal is projected.
AUDIO IN 2	Sound is output from AUDIO IN 2 terminal when video of preset input terminal is projected.
AUDIO IN 3	Sound is output from AUDIO IN 3 terminal when video of preset input terminal is projected.
HDMI AUDIO IN	Sound is output from the HDMI terminal.
NETWORK AUDIO IN	Sound is output from the NETWORK terminal.

PROJECTOR SETUP menu

DATE AND TIME

This lets you set the time zone and the current date and time for the projector's internal clock.

■ Setting the TIME ZONE

- 1) Press ▲ ▼ to select [DATE AND TIME].
- 2) Press the <ENTER> button.
 - The [DATE AND TIME] screen will be displayed.
- 3) Press ▲ ▼ to select [TIME ZONE].
- 4) Press ◀ ▶ to switch [TIME ZONE].

■ Adjusting the date and time manually

- 1) Press ▲ ▼ to select [DATE AND TIME].
- 2) Press the <ENTER> button.
 - The [DATE AND TIME] screen will be displayed.
- 3) Press ▲ ▼ to select [ADJUST CLOCK].
- 4) Press the <ENTER> button.
 - The [ADJUST CLOCK] screen will be displayed.
- 5) Press ▲ ▼ to select the item to be set, and press ◀ ▶ to set the local time.

NTP SYNCHRONIZATION	Refer to "Adjusting the date and time automatically". (▶ The right of this page.)
YEAR	2011 - 2035
MONTH	1 - 12
DAY	1 - 31
HOUR	0 - 23
MINUTE	0 - 59
SECOND	0 - 59

- 6) Press ▲ ▼ to select [OK], and press the <ENTER> button.
 - This completes setting of the time.

■ Adjusting the date and time automatically

- 1) Press ▲ ▼ to select [DATE AND TIME].
- 2) Press the <ENTER> button.
 - The [DATE AND TIME] screen will be displayed.
- 3) Press ▲ ▼ to select [ADJUST CLOCK].
- 4) Press the <ENTER> button.
 - The [ADJUST CLOCK] screen will be displayed.
- 5) Press ▲ ▼ to select [NTP SYNCHRONIZATION] and press ◀ ▶ to switch to [ON].
 - Each press of the button switches the settings as shown below.



OFF	Does not synchronize NTP server
ON	Synchronizes NTP server

- 6) Press ▲ ▼ to select [APPLY], and Press the <ENTER> button.
 - This completes setting of the time.

Note

- To set the date and time automatically, the projector must be connected to the network.
- If synchronization with the NTP server fails just after [NTP SYNCHRONIZATION] is turned [ON], or if [NTP SYNCHRONIZATION] is turned [ON] while the NTP server is not set, [NTP SYNCHRONIZATION] will return to [OFF].
- Access the projector via a web browser to set the NTP server. (For details, refer to "Operating Instructions, Network Operations")

TEST PATTERN

The test patterns do not reflect position, size and other adjustments. Be sure to display the input signal before making any test pattern settings.

- 1) Press **▲▼** to select **[TEST PATTERN]**.
- 2) Press the **<ENTER>** button.
 - [TEST PATTERN] will be displayed.
- 3) Press **◀▶** to switch test patterns.
 - You can return to [PROJECTOR SETUP] by pressing the **<MENU>** or **<RETURN>** button.

■ Display sequence of internal test patterns

Each press of the **◀▶** buttons switches the test patterns as shown below.

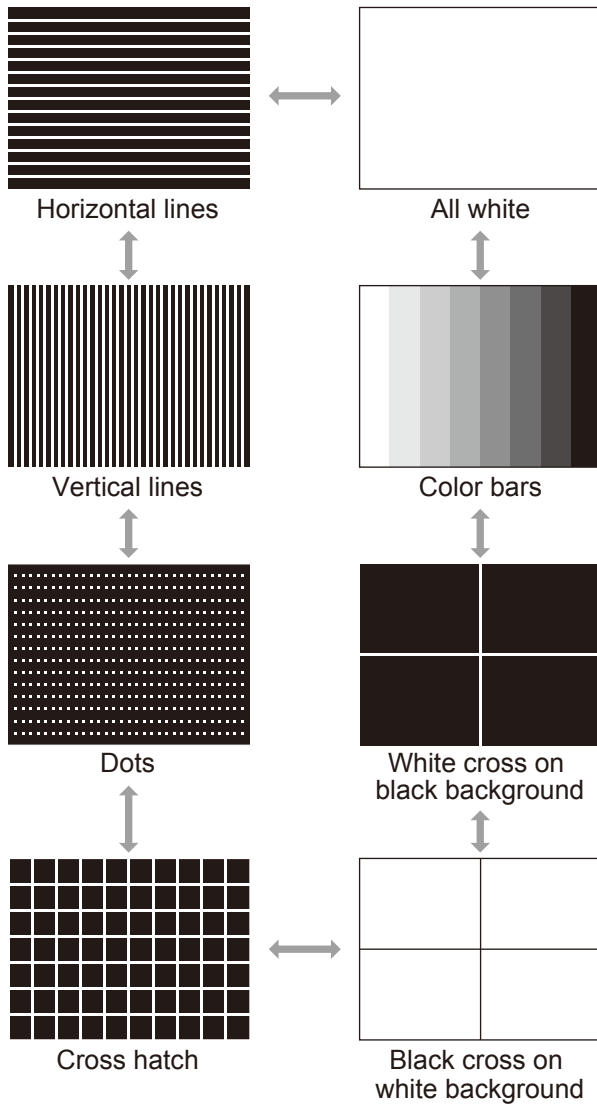

Note

- The default screen is all white. If you assign this to **<FUNC1>** to **<FUNC3>**, Cross hatch becomes the default.

INITIALIZE ALL

Use the steps below to return all adjusted “MENU” items to their factory defaults. When you perform this function, the projector enters standby mode to initialize.

- 1) Press **▲▼** to select **[INITIALIZE ALL]**.
- 2) Press the **<ENTER>** button.
 - [INITIALIZE ALL] appears.
 - A password must be entered, when [PASSWORD] in the [SECURITY] menu is set to [ON]. (➔page 64)
- 3) Press **◀▶** to select **[OK]**.
- 4) Press the **<ENTER>** button.
 - The [NOW INITIALIZING...] screen appears, and is followed by [POWER OFF].
- 5) Follow the screen instructions to turn off the power (➔page 30).
 - All other key operations are unavailable at this time.
 - The [LANGUAGE] and [INITIAL SETTING] screens appear the next time the projector is started. (➔page 16)

Note

- Projector runtime, lamp runtime and [NETWORK] settings are not initialized.
- After performing [INITIALIZE ALL], the password is returned to its factory default and [PASSWORD] is set to [OFF].

SECURITY menu

Select [SECURITY] from the Main Menu (see “Navigating through the menu” on page 35), then select the item from the sub-menu.

- When you operate the projector for the first time.
Factory default password:
Press ▲▶▼◀▲▶▼◀ and the <ENTER> button.
- After selecting the item, press ◀▶▲▼ to set.

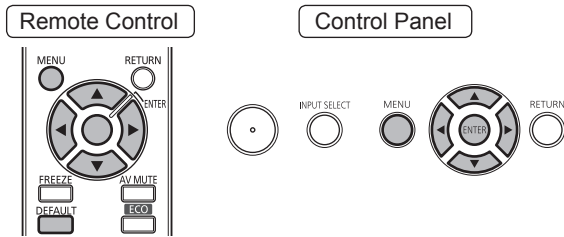

Attention

- Please set the settings after you display the [SECURITY] screen.
- When the [SECURITY] screen appears, password entry is required. Enter the registered security password to continue operations.
- If you changed the password before, please enter the password you registered and press the <ENTER> button.

Note

- Only asterisks * will appear on the screen to represent the actual characters of the password when the password is entered.

PASSWORD

The [PASSWORD] screen can be displayed when the power has been turned on. If the correct password is not entered, only POWER (⏻/⏻) button operations will be available.

1) Press ▲▼ to select [PASSWORD].

2) Press ◀▶ to switch [PASSWORD].

- The setting will change as follows each time the button is pressed.



OFF	Disables Password
ON	Enables Password

Note

- [PASSWORD] is set to [OFF] by default and when INITIALIZE ALL is executed.
- Change the SECURITY PASSWORD regularly and make it uneasy to guess.
- The password becomes valid when setting of the password is turned [ON] and then the MAIN POWER switch is turned off.

PASSWORD CHANGE

The password can be changed.

1) Press ▲▼ to select [PASSWORD CHANGE].

2) Press the <ENTER> button.

- The [PASSWORD CHANGE] screen will be displayed.

3) Press ▲▼◀▶ and numeral keys to set the password.

- Up to 8 buttons can be set as the password.

4) Press the <ENTER> button.

5) For the purposes of confirmation, enter the password again.

6) Press the <ENTER> button.

Note

- Only asterisks * will appear on the screen to represent the actual characters of the password when the password is entered.
- If the wrong password is entered, an error message appears on the screen. Enter the correct password again.
- When numerals are used in the SECURITY PASSWORD, initialization of the security password will be necessary if the remote control is lost. For the method of initialization, consult your dealer.

DISPLAY SETTING

You can display the security message (text and image) on the projected image.

- 1) Press ▲▼ to select [DISPLAY SETTING].
- 2) Press ◀▶ to switch [DISPLAY SETTING].
 - The setting will change as follows each time the button is pressed.

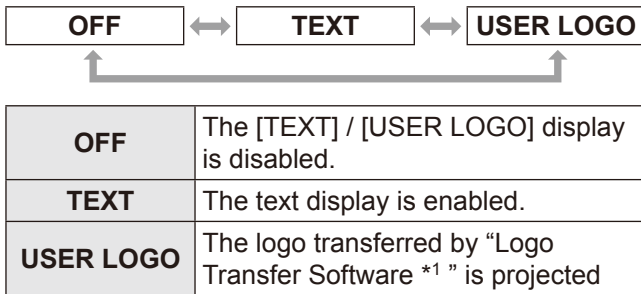

*1 : "Logo Transfer Software" is included on the supplied CD-ROM.

Note

- To create the image for [USER LOGO], "Logo Transfer Software" included in the supplied CD-ROM is required.
- You cannot display both security message and closed caption at the same time.

TEXT CHANGE

You can enter your original text to be displayed when [DISPLAY SETTING] is turned [TEXT].

- 1) Press ▲▼ to select [TEXT CHANGE].
- 2) Press the <ENTER> button.
 - The [TEXT CHANGE] screen will be displayed.
- 3) Press ▲▼◀▶ to select characters and press <ENTER> button to input them.
 - Up to 22 characters can be input.
- 4) Press ▲▼◀▶ to select [OK], and Press the <ENTER> button.
 - The text is now changed.

MENU LOCK

Display the Menu and enable Menu operation by pressing <MENU> button.

- 1) Press ▲▼ to select [MENU LOCK].
- 2) Press ◀▶ to switch [MENU LOCK].
 - The setting will change as follows each time the button is pressed.

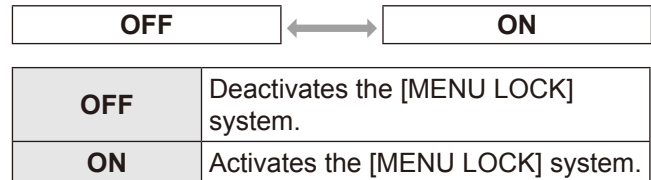

Note

- Once [MENU LOCK] is set to [ON], you cannot use <MENU> button unless you input the correct password.
- The [MENU LOCK] is set to [OFF] by default and when INITIALIZE ALL is executed.
- The unlock state is maintained until the projector is set to the standby mode.

MENU LOCK PASSWORD

You can change the password for [MENU LOCK] system.

- 1) Press ▲▼ to select [MENU LOCK PASSWORD].
- 2) Press the <ENTER> button.
 - The [MENU LOCK PASSWORD] screen will be displayed.
- 3) Press ▲▼◀▶ to select characters and press the <ENTER> button to input them.
 - Up to 16 characters can be input.
- 4) Press ▲▼◀▶ to select [OK], and Press the <ENTER> button.
 - To stop, select [CANCEL].

Attention

- The password is "AAAA" by default or when INITIALIZE ALL is executed.
- Change the MENU LOCK PASSWORD regularly and make it uneasy to guess.

SECURITY menu

CONTROL DEVICE SETUP

You can enable/disable the button operations of the Control panel of the main unit and remote control.

- 1) Press ▲ ▼ to select [CONTROL DEVICE SETUP].
- 2) Press the <ENTER> button.
 - The [CONTROL DEVICE SETUP] screen will be displayed.
- 3) Press ▲ ▼ to select items and ◀ ▶ to switch settings.
 - If you choose [DISABLE], select [OK] and press <ENTER> button in the confirmation screen that appears.

■ CONTROL PANEL

Restriction of control from the main unit controls can be set.

- Each press of the button switches the settings as shown below.

ENABLE	↔	DISABLE
ENABLE		Enables control from the main unit controls.
DISABLE		Disables control from the main unit controls.

■ REMOTE CONTROLLER

Restriction of control from the remote control can be set.

- Each press of the button switches the settings as shown below.

ENABLE	↔	DISABLE
ENABLE		Enables control from the remote control.
DISABLE		Disables control from the remote control.

Note

- If you [DISABLE] both of the [CONTROL PANEL] and [REMOTE CONTROLLER] buttons, you cannot turn the power [OFF] (return to the standby mode).

Cancelling a [DISABLE] setting:

Press the <ENTER> button while holding down the <MENU> button for 2 seconds on the main unit controls to reset a [DISABLE] setting on the "CONTROL PANEL" to [ENABLE].

Use the projector to change [REMOTE CONTROLLER] settings.

NETWORK

Select **[NETWORK]** from the Main Menu (see “Navigating through the menu” on page 35), then select the item from the sub-menu.

- After selecting the item, press ▲▼◀▶ to set.

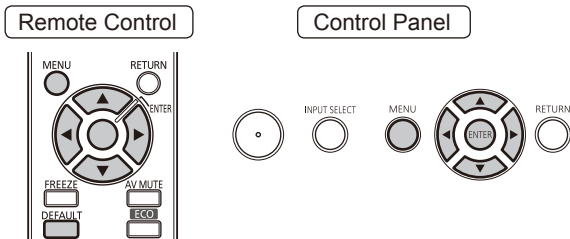

Note

- Set this to connect the projector to a computer via a network. For details of PJ Link Network, see “Operation Manual, Network Operations”.
- When **[PASSWORD]** in the **[SECURITY]** menu is **[ON]**, a password is required to initialize the network.

WIRED LAN

You can set Wired LAN.

WIRELESS LAN *1

You can set Wireless LAN.

NAME CHANGE

You can change the name of the projector.

PASSWORD SETTING

When you connect the projector using Wireless Manager ME5.5, you can set the password and restrict the access to the projector by setting this to **[ON]**.
(Factory default is **[OFF]**.)

PASSWORD CHANGE

You can change the password for network.

NETWORK CONTROL

You can set the method of network control.
(Factory default is **[ON]**.)

LIVE MODE CUT IN

When Live Mode is activated (images are being sent) using Wireless Manager ME5.5, you can permit cut in connection by other users by setting this to **[ON]**.
(Factory default is **[OFF]**.)

COMPUTER SEARCH *1

You can search for a computer to connect to using Wireless Manager ME5.5.

MULTI-LIVE

Used when connecting to a computer using Wireless Manager ME5.5.

STATUS

Shows the network status of the projector.

INITIALIZE

You can use this function to return network settings to their factory defaults.

- *1 : Settable only when the optional wireless module (ET-WM200U) is attached.

LAMP, TEMP and FILTER Indicators

Managing the indicated problems

If a problem should occur inside the projector, the LAMP, TEMP and/or FILTER indicators will inform you. Manage the indicated problems as follow.

CAUTION

- Before you take a remedial measure, follow the procedure of switching the power off indicated in “Powering off the projector”. (➡page 30)
- If multiple indicators light or blink, verify the status of the projector by looking at each indicator.

Note

- Confirm the status of the power indicated on the POWER indicator. (➡page 28)

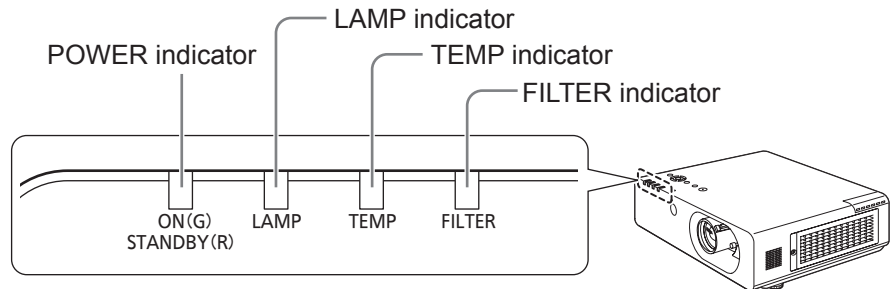

LAMP indicator

Indicator	Lighting in red	Blinking in red	
Status	Indicates the time to replace the lamp unit. Lights when the duration of the lamp unit exceeds 5800 hours.	Luminous lamp does not light or ceases lighting during operation.	
Check	Is a message to recommend replacing lamp unit displayed on screen after turning the power on?	Have you turned the power back on immediately after the power had been turned off? Does power outage occur?	Turn off the power. And turn the power back on again.
Remedy	Replace the lamp unit. (➡page 72)	Wait for 90 seconds or longer to let the luminous lamp become cooler. Then, turn the power on.	Turn off the power in accordance with “Powering off the projector” (➡ page 30) and consult your dealer.

Note

- Contact your dealer for repair services when <Lamp indicator> persists to light or flash after taking these measurements.
- When the setting of [HIGH ALTITUDE MODE] to [OFF] at an elevation of 1400 m (4593 ft) or more, the life of the lamp unit becomes shorter.

LAMP, TEMP and FILTER Indicators

TEMP indicator

Indicator	<ul style="list-style-type: none"> Lights in red while projecting. ([REFER TO THE “TEMP indicator” SECTION IN THE OPERATION MANUAL] appears on the screen.) Blinking in red when the power is off. (Projection stops automatically.) 		
Status	The internal or external temperature is abnormally high.		
Check	Is the ventilating port (intake/exhaust) blocked?	Is the temperature of the environment too high?	Is [HIGH ALTITUDE MODE] properly set?
Remedy	Remove the obstacles from the intake and exhaust ports.	Place the projector in the environment with temperature and humidity designated in the specifications. (➔page 86)	You can operate the projector for only two minutes after the power is turned on. If you use the projector at an altitude from 1400 m (4593 ft) to 2700 m (8858 ft) above sea level. Set [HIGH ALTITUDE MODE] to [ON], in two minutes. (➔page 57) Do not use the projector at an altitude of 2700 m (8858 ft) or higher above sea level. (➔page 57)

Note

- Clean the air filter unit when <TEMP indicator> persists to light or flash after taking above remedies (➔page 70). Contact to your dealer when <TEMP indicator> persists to light or flash after cleaning the air filters.

FILTER indicator

Indicator	<ul style="list-style-type: none"> Lights in red. (“Clean the air filter” appears on the screen) Blinking unusually fast in red while the power is off. (Projection stops automatically.) 			Blinks in red. (The projection automatically stops after ten minutes)
Status	The internal or external temperature is abnormally high.			Air filter unit is not attached.
Check	Is the ventilating port (intake/exhaust) blocked?	Is [HIGH ALTITUDE MODE] properly set?	Is the air filter unit dirty?	Is the air filter unit attached?
Remedy	Remove the obstructions from the intake and exhaust ports.	<ul style="list-style-type: none"> You can operate the projector for only two minutes after the power is turned on. If you use the projector at an altitude from 1400 m (4593 ft) to 2700 m (8858 ft) above sea level, set [HIGH ALTITUDE MODE] to [ON] within the two minutes. Do not use the projector at an altitude of 2700 m (8858 ft) or higher above sea level. (➔page 57) 	Please perform maintenance of the air filter unit. (➔page 70)	Please attach air filter unit. (➔page 71)

Note

- If <FILTER indicator> persists to light or blink after taking these measurements, please contact your dealer for repair services.

Replacement

Before replacing the unit

- When you perform maintenance or replacement of the parts, make sure to turn off the power and disconnect the power plug from the wall outlet. (▶ pages 28, 30)
- Be sure to observe the procedure “Powering off the projector” (▶ page 30) when performing power supply operation.

Maintenance

Outer Case

Wipe off dirt and dust using a soft dry cloth.

- If the dirt is persistent, soak the cloth with water and wring it thoroughly before wiping. Dry off the projector with a dry cloth.
- Do not use benzene, thinner, or rubbing alcohol, other solvents, household cleaners, or chemical treated dusters. Using them may cause deterioration of the outer case.

Front glass surface of the lens

Wipe off the dirt and dust off the front surface of the lens with soft clean cloth.

- Do not use a cloth that has an abrasive surface or a cloth that is moist, oily, or covered with dust.
- Do not use excessive force when wiping the lens as it is fragile.

Attention

- The lens is made of glass. Impacts or excessive force when wiping may scratch its surface. Please handle with care.

Air filter

Perform the maintenance of the air filter unit in following cases.

- The filter mesh is blocked, causing the filter replacement message to appear on the screen and the <FILTER Indicator> to light in red.
- The filter mesh is blocked, causing the internal temperature to rise, the <TEMP Indicator> to light, and the power to shut off. (When the power is shut off, the <TEMP Indicator> blinks in red and the <FILTER Indicator> blinks faster than usual.)

1) Use a Phillips screwdriver to loosen the air filter cover screw until it turns freely. Then, remove the air filter cover

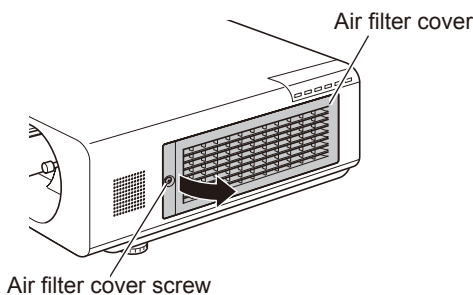

2) Remove the air filter unit

- Hold the knobs on the front of the unit and pull the unit towards you.

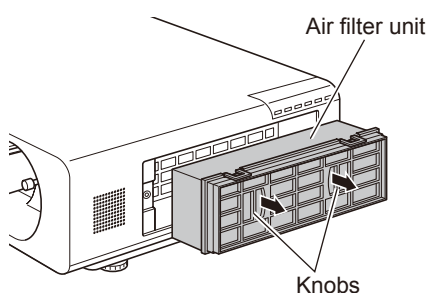

3) Clean and dry the air filter unit

• Cleaning the air filter unit

- (1) Soak the air filter unit in the water (cold or warm) and rinse lightly.
 - Do not use brushes or other cleaning tools.
 - When you rinse the air filter unit, hold the frame of the air filter unit and do not apply excessive force to the filter portion.
- (2) Rinse the filters two or three times, changing the water each time.
 - Insufficient rinsing may result in odors.

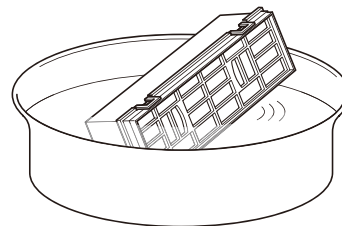

● Drying the air filter unit

- Leave the filters to dry in a well-ventilated location that is not exposed to excessive dust.
- Do not use a drier or similar device to dry the air filter unit.

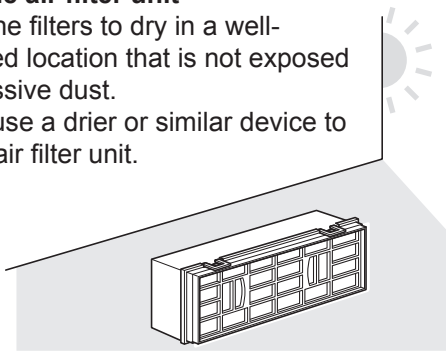

Attention

- After cleaning the air filter unit, make sure that it is sufficiently dry before reinstalling it to the projector. Installing the air filter unit while it is wet will result in electric shock or malfunction.

Note

- Be sure to install the air filter properly. If the projector is operated without the air filter installed, the projector will shut off after ten minutes to prevent damage from incoming dirt and dust. (In such cases, the remaining time before shutdown is displayed in one-minute increments.)
- Replace the air filter with a replacement filter unit (ET-EMF100) when cleaning fails to remove dirt or dust, or when the air filter unit breaks.
- Air filter replacement is recommended after cleaning the unit two times.
- The dust-proof properties may reduce after each cleaning.

4) Install the air filter unit to the projector.

- The air filter unit has no distinction between top and bottom.
- Perform step 2) in the reverse order.

5) Attach the air filter cover to the projector and secure the filter cover screw using a Phillips screwdriver.

- Perform step 1) in the reverse order.

Replacing the unit

Air filter unit

Replace the air filter when cleaning fails to remove dirt or dust.

Replace it with the separately sold ET-EMF100 replacement filter unit. Consult your supplier when you purchase a replacement filter.

Replacement of the air filter unit

1) Remove the air filter cover.

- Use a Phillips screwdriver to turn the air filter cover screw counterclockwise until the screw turns freely to remove the air filter cover.

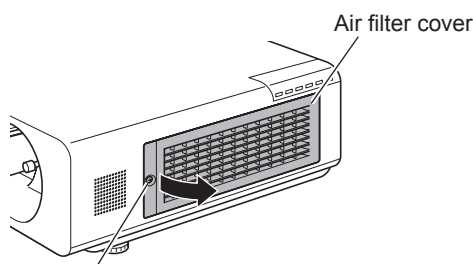

Air filter cover screw

2) Remove the air filter unit.

- Pull the air filter unit out from the projector holding the knob of the air filter unit.

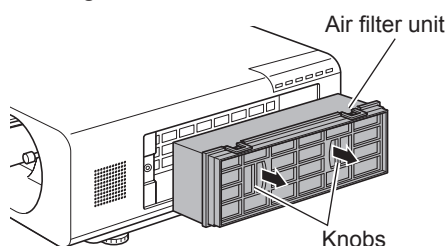

3) Attach the separately sold replacement filter unit (ET-EMF100) to the projector.

- The air filter unit has no distinction between top and bottom.
- Attach the air filter unit by performing step 2) in reverse order.

4) Attach the air filter cover to the projector and tighten the air filter cover screw using a Phillips screwdriver.

- Attach the air filter cover by performing step 1) in reverse order.

Attention

- Turn off the power before you replace the air filter unit.
- When attaching the air filter unit, make sure that the projector is stable, and work in an environment that is safe, even in the event of the air filter unit dropping.
- Do not turn on the projector without an air filter unit attached. If the projector is used without the air filter, dirt and dust that enters the projector may damage it.

Replacement

Lamp unit

The lamp unit is a consumable component. You can check the total usage time using STATUS in the PROJECTOR SETUP menu on page 56.

It is recommended to ask an authorized engineer to replace the lamp unit. Contact your dealer. Consult your dealer to purchase a replacement lamp unit (ET-LAF100A, dealt as a service component).

CAUTION:

- Do not replace the lamp unit when it is hot. (Wait at least one hour after use.)

The inside of the cover can become very hot, take care to avoid burn injuries.

Notes on the replacement of the lamp unit

- The luminous source of the lamp is made of glass and may burst if you hit it against a hard surface or drop it. Please handle with care.
- A Phillips screwdriver is required for replacement of the lamp unit.
- When replacing the lamp unit, be sure to hold it by the handle.
- Hold the lamp unit horizontally while replacing it to prevent fragments of glass from scattering, in case the lamp breaks. When the projector is mounted on a ceiling, do not work directly under the projector or put your face close to the projector. Pull the old lamp unit out horizontally.
- The lamp contains mercury. Consult your local municipality or your dealer about correct disposal of used lamp units.

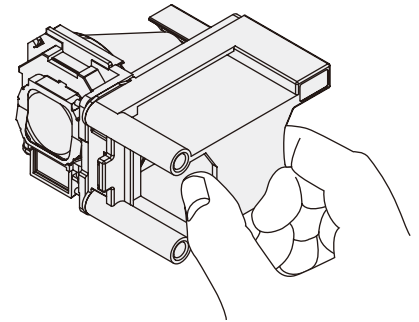



Attention

- Do not use other than designated lamp units.
- The part numbers of accessories and separately sold components are subject to change without notice.

When to replace the lamp unit

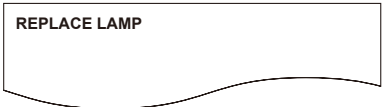
The lamp unit is a consumable component. Brightness decreases according to duration of usage, so periodical replacement of the lamp unit is necessary. 6000 hours of use is a rough guideline for replacement. However, a lamp unit may not light before 6000 hours of use, depending on individual lamp, usage, and environmental conditions. It is recommended to prepare spare units in advance. The risk of the lamp bursting increases after 6000 hours of use. To prevent this, the projector will automatically turn the lamp off approximately ten minutes after it is turned on in such cases. It is recommended that you replace the lamp unit before this occurs.

	On screen	LAMP indicator
		
Over 5800 hours	The message is displayed for 30 seconds. If you press any button within the 30 seconds, the message disappears.	Lights in red (even in stand-by mode).
Over 6000 hours	After ten minutes, the projector shuts off the power automatically.	

Note

- 6000 hours of use is a rough guideline, but this is not a guarantee.

Replacing the Lamp unit

CAUTION:

- When the projector is mounted on a ceiling, do not work with your face close to the projector.
- Attach the lamp unit and the lamp cover securely.
- When you experience difficulty in installing the lamp, remove it and try again. If you use force to install the lamp, the connector may be damaged.

1) Turn off the Main Power by following the procedure in “Powering off the projector” (→page 30). Unplug the mains lead from the mains socket. Wait at least one hour and make sure the lamp unit and surroundings are cool.

2) Use a Phillips screwdriver to loosen the two lamp cover fixing screws on the back of the projector until the screws turn freely, and remove the lamp cover.

- Remove the lamp cover by pulling it slowly toward the direction of the arrow.

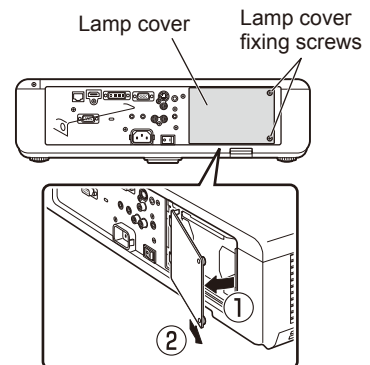

3) Use a Phillips screwdriver to loosen the two lamp unit fixing screws until the screws turn freely. Hold the used lamp unit by its handles, and pull it gently from the projector.

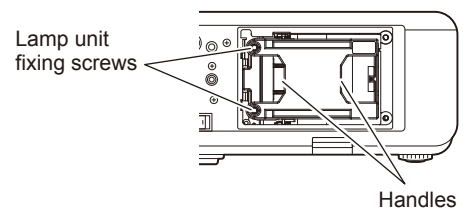

4) Insert the new lamp unit in correct direction. Tighten the two lamp unit fixing screws securely with a Phillips screwdriver.

When inserting the lamp unit, press position A firmly.

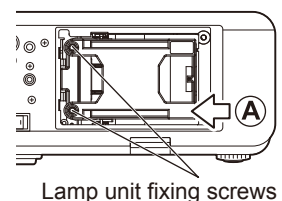

5) Attach the lamp cover, and tighten the two lamp cover fixing screws securely with a Phillips screwdriver.

- Attach the lamp cover by pushing it slowly toward the direction of the arrow.

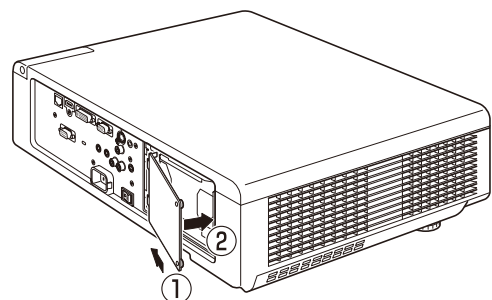

Note

- When you replace the new lamp unit (ET-LAF100A), the projector resets the total usage time of the lamp unit automatically.

Cautions on Wireless Module Installation

The optional Wireless Module (part number ET-WM200U) is required to use wireless LAN functions.

Before installing the wireless module to the projector, remove the protective sticker and cap from the wireless module.

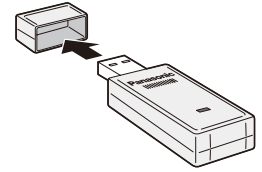

Procedure

1) Use a Phillips screwdriver to loosen the Wireless Module cover screw until it turns freely. Then, remove the Wireless Module cover.

- Remove the Wireless Module cover by moving it in the direction of the arrow.

2) Face the LED lamp of the Wireless Module upward, and insert the Wireless Module into the Wireless Module connection terminal.

3) Attach the Wireless Module cover to the projector and tighten the Wireless Module cover screw using a Phillips screwdriver.

- Place the Wireless Module cover from the top and slide it in.

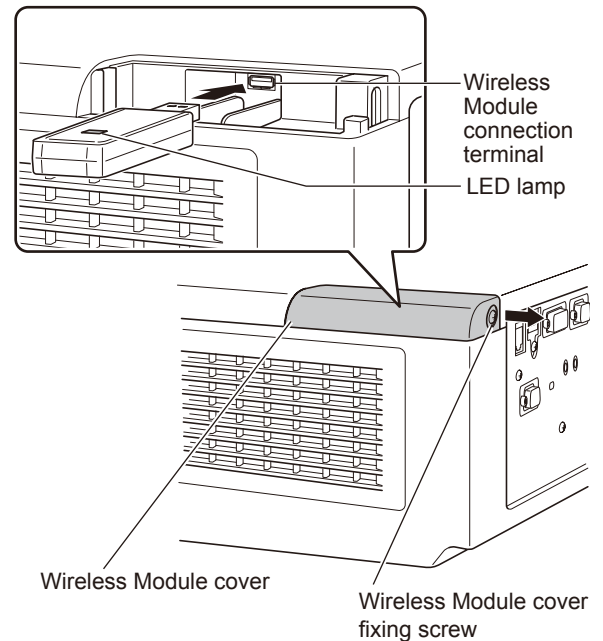

Attention

- Keep the small parts out of the reach of small children.
- Tighten screws using a torque screwdriver or others. Do not use an electric screwdriver or an impact screwdriver.
- The serial number of accessories and optional parts is subject to change without notice.
- Do not insert wireless module other than the optional ET-WM200U.

Troubleshooting

Please check following points. For details, see the corresponding pages.

Problem	Cause	Reference page
Power does not turn on.	● The power cord may not be connected.	—
	● The <MAIN POWER> switch is turned off.	30
	● No electric supply is at the wall outlet.	—
	● The circuit breakers have tripped.	—
	● Is the <LAMP indicator>, <TEMP indicator>, or <FILTER indicator> lit or blinking?	68, 69
	● The lamp cover has not been securely installed.	73
No picture appears.	● The video signal input source may not be connected to a terminal properly.	27
	● The input selection setting may not be correct.	32
	● The [BRIGHTNESS] adjustment setting may be at the minimum setting.	38
	● The input source which is connected to the projector may have a problem.	—
	● The [AV MUTE] function may be in use.	32
The picture is fuzzy.	● The lens focus may not have been set correctly.	31
	● The projector may not be at the correct distance from the screen.	22
	● The lens may be dirty.	14
	● The projector may be tilted too much.	—
The color is pale or grayish.	● [COLOR] or [TINT] adjustment may be incorrect.	39
	● The input source which is connected to the projector may not be adjusted correctly.	—
	● RGB cable is damaged.	—
No sound from the internal speaker	● The input terminals may not have been correctly connected.	27
	● The volume may have been set to the minimum level.	34
	● The AV mute function may have been turned on.	32
	● A cable may have been connected to the "VARIABLE AUDIO OUT" terminal.	19
	● Check the [AUDIO IN SELECT] [AUDIO SETTING].	61
The remote control does not operate.	● The batteries may be weak.	—
	● The batteries may not have been inserted correctly.	20
	● The remote control signal receptor on the projector may be obstructed.	17
	● The remote control unit may be out of the operation range.	17
	● Strong light such as fluorescent shine onto the signal receptor.	17
	● [REMOTE CONTROLLER] of [CONTROL DEVICE SETUP] in [SECURITY] menu is [DISABLE].	66
	● The remote control ID setting is incorrect.	20, 56
The control buttons of the projector do not operate.	● The [CONTROL PANEL] may have been set to [DISABLE].	66
	● If you lost the remote control after making the [DISABLE] setting, press the <ENTER> button while holding down the <MENU> button for 2 seconds on the main unit controls to reset the [ENABLE] setting.	66

Troubleshooting

Problem	Cause	Reference page
The picture does not display correctly.	<ul style="list-style-type: none"> ● [TV SYSTEM] and [RGB / YP_BPR] may not have been set correctly. 	41
	<ul style="list-style-type: none"> ● There may be a problem with the VCR or other signal source. 	—
	<ul style="list-style-type: none"> ● A signal which is not compatible with the projector is being input. 	83
Picture from a computer does not appear.	<ul style="list-style-type: none"> ● The cable may be longer than the optional cable. (Use a cable that does not exceed 10 m.) 	—
	<ul style="list-style-type: none"> ● The external video output from a laptop computer may not be correct. (You may be able to change the external output settings by pressing the [Fn] + [F3] or [Fn] + [F10] keys simultaneously. The actual method varies depending on the type of computer; refer to the documentation provided with your computer for further details.) 	—
	<ul style="list-style-type: none"> ● Is [DVI-I] set to [ANALOG] when inputting analog signals to DVI-I? 	—
Picture from a computer DVI-D graphic board does not appear.	<ul style="list-style-type: none"> ● [DVI-IN] setting is not set to [EDID2(PC)]. 	50
	<ul style="list-style-type: none"> ● The graphic board driver of the computer may need to be updated to the latest version. 	—
	<ul style="list-style-type: none"> ● Is [DVI-I IN] set to [DIGITAL]? 	—
	<ul style="list-style-type: none"> ● The computer may need to be restarted after switching [DVI-I IN] 	50
Picture from a HDMI device does not appear or picture is not stable.	<ul style="list-style-type: none"> ● Is the HDMI cable securely connected? 	27
	<ul style="list-style-type: none"> ● Turn off the power of the projector and the connected devices. Then turn the power of the projector and the connected devices back on. 	—
	<ul style="list-style-type: none"> ● Is an unsupported signal cable connected? 	83
No sound is output from a HDMI device.	<ul style="list-style-type: none"> ● Set the sound channel of the attached device to Linear PCM. 	—
	<ul style="list-style-type: none"> ● Check the [AUDIO IN SELECT] setting of [AUDIO SETTING]. 	61
	<ul style="list-style-type: none"> ● If no audio signal is output during HDMI cable connection, connect the audio cable to any of AUDIO IN 1 to 3 terminals. 	61
Projection starts when the power button is not pressed	<ul style="list-style-type: none"> ● Is [INITIAL START UP] of [PROJECTOR SETUP] set to [ON]? 	56
	<ul style="list-style-type: none"> ● Did you end projection by setting <MAIN POWER> to [OFF] during the previous session? If you set [INITIAL START UP] of [PROJECTOR SETUP] to [LAST MEMORY] and end projection using the direct power off function (➔ page 30) during the previous session, projection will start when you set <MAIN POWER> to [ON]. 	29
	<ul style="list-style-type: none"> ● Did you press <POWER (⏻/)> immediately after setting <MAIN POWER> to [OFF]? 	—
	<ul style="list-style-type: none"> ● If you set [INITIAL START UP] of [PROJECTOR SETUP] to [LAST MEMORY] and press <POWER (⏻/)> immediately after setting <MAIN POWER> to [OFF], projection may start simply by setting <MAIN POWER> to [ON]. After setting <MAIN POWER> to [OFF], do not operate the <POWER (⏻/)> button on the remote control and the control panel of the main unit while the Power indicator is lit or blinking in red. 	—

Note

- If the problem persists, after confirming the contents of the table, please consult your dealer.

Technical Information

Serial terminal

The serial connector which is on the connector panel of the projector conforms to the RS-232C interface specification, so that the projector can be controlled by a personal computer which is connected to this connector.

■ Connection

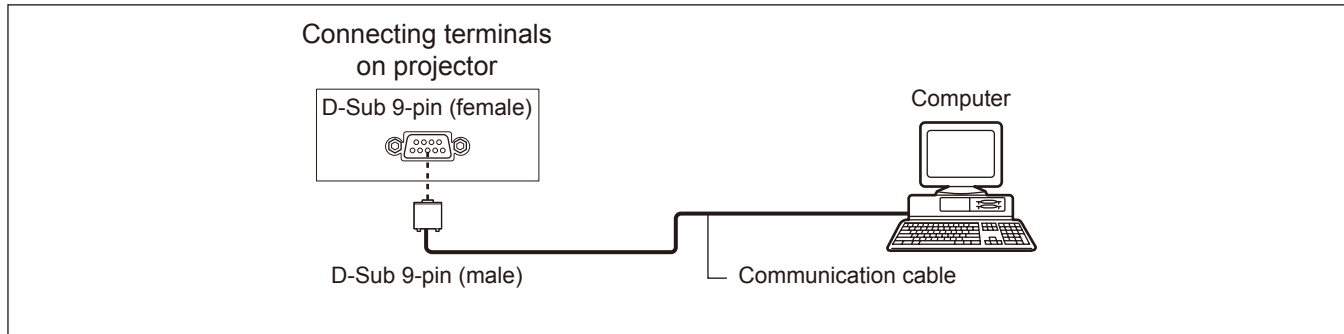

■ Pin assignments and signal names

D-Sub 9-pin (female) Outside view	Pin No.	Signal name	Contents
<p>⑥ → ⑨</p> <p>① → ⑤</p>	①	—	NC
	②	TXD	Transmitted data
	③	RXD	Received data
	④	—	NC
	⑤	GND	Earth
	⑥	—	Connected internally
	⑦	CTS	
	⑧	RTS	
	⑨	—	NC

■ Communication conditions

Signal level	RS-232C-compliant
Sync. method	Asynchronous
Baud rate	9 600 bps
Parity	None

Character length	8 bits
Stop bit	1 bit
X parameter	None
S parameter	None

Technical Information

Basic format

Transmission from the computer begins with STX, then the ID, command, parameter, and ETX are sent in this order. Add parameters according to the details of control.

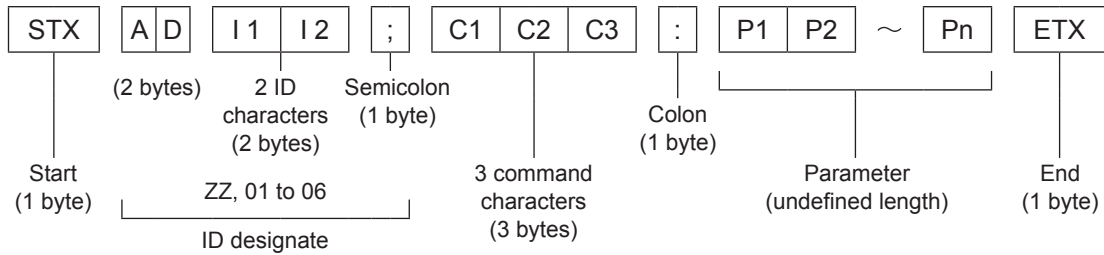

*: When sending commands without parameters, a colon (:) is not necessary.

Basic format (with sub command)

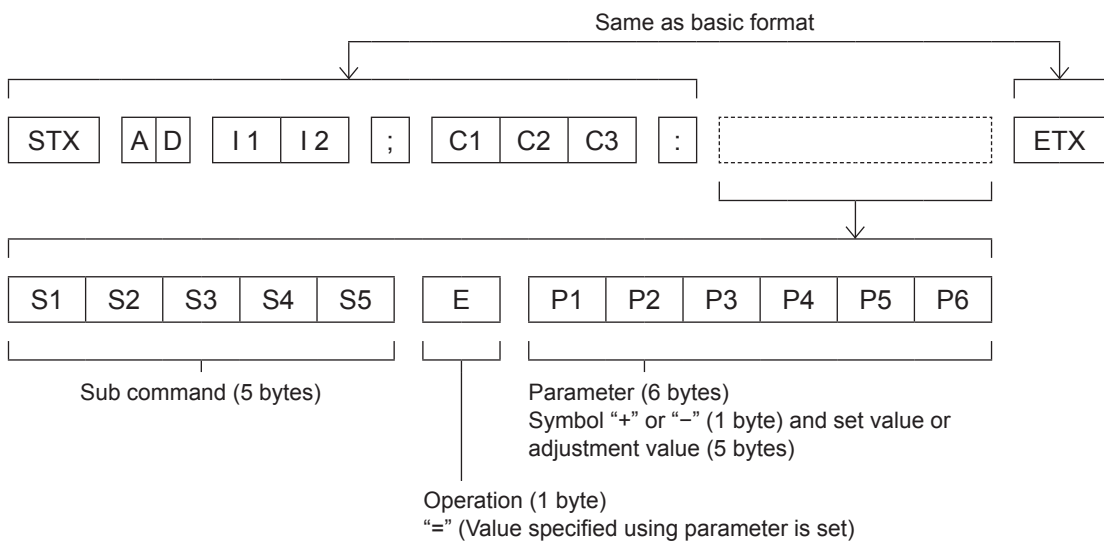

*: When transmitting a command which does not need a parameter, the operation (E) and parameter are not necessary.

Attention

- No command can be sent or received for 60 seconds after the lamp starts lighting. Try sending any command after that period has elapsed.
- When transmitting multiple commands, be sure to wait until 0.5 seconds has elapsed after receiving the response from the projector before sending the next command.

Note

- As with the PT-F300U/PT-FW300U and similar models, formats without an ID designation can also be used.
- When the command can not be executed, the [ER401] status is sent from the projector to the personal computer.
- When the wrong parameter is sent, the [ER402] status is sent from the projector to the personal computer.
- Projector ID supported on the RS-232C interface is ZZ (ALL) and a group of 01 to 06.
- If a command is sent with a projector ID specified, the projector will return answer back only in the following cases:
If it coincides with the projector ID (➡ page 56)
If the ID specification is ALL and responding (ID ALL) is [ON] (➡ page 56)
- STX and ETX are hexadecimal character codes indicating 02 and 03, respectively.

■ Cable specifications

[When connected to a computer]

Projector	1	NC	NC	1	Computer (DTE specifications)
	2			2	
	3			3	
	4	NC	NC	4	
	5			5	
	6	NC	NC	6	
	7			7	
	8			8	
	9	NC	NC	9	

■ Control commands

When controlling the projector from a computer, the following commands are available:

[Projector control command]

Command	Control contents	Remarks
PON	Power [ON]	In stand-by mode, all commands other than [PON] are invalid. During lamp ON operation, the [PON] command is not accepted.
POF	Power [OFF]	If the [PON] command is sent while the cooling fan is operating after the lamp has been switched off, the lamp ON operation will start 30 seconds after the lamp has turned off, in order to protect the lamp.
AVL	Volume	(Parameter) 000 (adjustment value 0) to 063 (adjustment value 63)
IIS	INPUT selection	(Parameter) VID = VIDEO SVD = S -VIDEO RG1 = COMPUTER DVI = DVI-I HD1 = HDMI NWP = NETWORK
Q\$\$	Lamp condition query	(Call back) 0 = Stand-by 1 = Lamp ON control active 2 = Lamp ON 3 = Lamp OFF control active
OSH	AV MUTE function	Turning off the projection and sound temporarily. Sending the command switches ON/OFF. Do not switch ON/OFF in a short period of time.

Other terminals

Pin assignments and signal names of <S-VIDEO IN> terminal

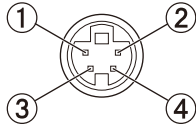
Outside view	Pin No.	Signal names
	①	GND (luminance signal)
	②	GND (color signal)
	③	Luminance signal
	④	Color signal

Pin assignments and signal names of <RGB2 IN> terminal

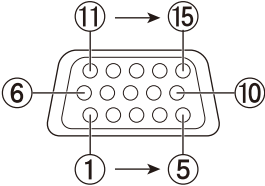
Outside view	Pin No.	Signal names
	①	R/P _R
	②	G/G · SYNC/Y
	③	B/P _B
	⑫	DDC data
	⑬	HD/SYNC
	⑭	VD
	⑮	DDC clock

④, ⑨ : Not assigned
⑤ - ⑧, ⑩, ⑪ : GND terminals

Pin assignments and signal names of <HDMI IN> terminal

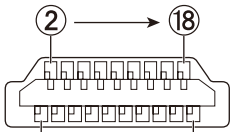
Outside view	Pin No.	Signal names	Pin No.	Signal names
<p>Even-numbered pins ② to ⑱</p>  <p>Odd-numbered pins ① to ⑱</p>	①	T.M.D.S data 2+	⑪	T.M.D.S clock shield
	②	T.M.D.S data 2 shield	⑫	T.M.D.S clock -
	③	T.M.D.S data 2-	⑬	CEC
	④	T.M.D.S data 1+	⑭	—
	⑤	T.M.D.S data 1 shield	⑮	SCL
	⑥	T.M.D.S data 1-	⑯	SDA
	⑦	T.M.D.S data 0+	⑰	DDC/CEC GND
	⑧	T.M.D.S data 0 shield	⑱	+5V
	⑨	T.M.D.S data 0-		Hot plug detection
	⑩	T.M.D.S clock +		

Pin assignments and signal names of <DVI-I IN> terminal

Outside view	Pin No.	Signal names	Pin No.	Signal names
<p>The diagram illustrates the pin assignments for the DVI-I IN terminal. The top part shows a side view of the connector with pins 1 through 24 labeled. The bottom part shows a top-down view of the connector with pins C1 through C5 labeled.</p>	①	T.M.D.S data 2-	⑯	Hot plug detection
	②	T.M.D.S data 2+	⑰	T.M.D.S data 0-
	③	T.M.D.S data 2/4 shield	⑱	T.M.D.S data 0+
	④	—	⑲	T.M.D.S data 0/5 shield
	⑤	—	⑳	—
	⑥	DDC clock	㉑	—
	⑦	DDC data	㉒	T.M.D.S clock shield
	⑧	Analog VD	㉓	T.M.D.S clock +
	⑨	T.M.D.S data 1-	㉔	T.M.D.S clock -
	⑩	T.M.D.S data 1+	C1	Analog R/P _R
	⑪	T.M.D.S data 1/3 shield	C2	Analog G/G SYNC/Y
	⑫	—	C3	Analog B/P _B
	⑬	—	C4	Analog HD/SYNC
	⑭	+5V	C5	Analog GND
	⑮	GND		

Technical Information

Two window display combination list (PT-FW430U Only)

Subwindow		Computer		DVI-I analog		VIDEO input	S-VIDEO input	DVI-I digital		HDMI		NETWORK
		RGB input	YP _B P _R input	RGB input	YP _B P _R input			Moving image system ^{*1}	RGB system ^{*2}	Moving image system ^{*1}	RGB system ^{*2}	
Main window	Computer											
		RGB input			○	○	○	○	○	○	○	○
	YP _B P _R input			○	△	△	△	△	○	△	○	○
DVI-I analog	RGB input	○	○			○	○			○	○	○
	YP _B P _R input	○	△			△	△			△	○	○
VIDEO input		○	△	○	△		×	△	○	△	○	○
S-VIDEO input		○	△	○	△	×		△	○	△	○	○
DVI-I digital	Moving image system ^{*1}	○	△			△	△			×	×	○
	RGB system ^{*2}	○	○			○	○			×	×	○
HDMI	Moving image system ^{*1}	○	△	○	△	△	△	×	×			○
	RGB system ^{*2}	○	○	○	○	○	○	×	×			○
NETWORK		○	○	○	○	○	○	○	○	○	○	

○ : SIDE BY SIDE combination is possible

×

△ : SIDE BY SIDE combination is possible on the following conditions.

(An image may be unstable in the sub-window under some conditions.)

1) The SIDE BY SIDE signals have the same vertical scanning frequency.

2) SIDE BY SIDE combination has signals other than the combination of Interlace signals by Interlace signals.

*1 : Only 525p(480p), 625p(576p), 750(720)/60p, 750(720)/50p, 1125(1080)/60i, 1125(1080)/50i, 1125(1080)/24p, 1125(1080)/50p, 1125(1080)/60p.

*2 : VGA (640 × 480) - WUXGA (1 920 × 1 200)

non-interlace signal, Dot clock frequency : 25 MHz - 162 MHz

(The WUXGA signals support only VESA CVT-RB (Reduced Blanking) signals.)

Note

- If the horizontal resolution of the input signal of the sub window is 1 280 pixels or above, the picture quality of the sub window may be lowered.
- Some input signals may not display when 1125 (1080)/60p or WUXGA input signals are selected.

List of compatible signals

The following table specifies the types of signals compatible with the projectors.

Format : V = VIDEO, S = S-VIDEO, D = DVI, C = COMPUTER, Y = YP_BPr, H = HDMI

Mode	Display resolution *1 (dots)	Scanning frequency		Dot clock frequency (MHz)	Picture quality *2		PnP					Format		
		H (kHz)	V (Hz)		PT- FW430U	PT- FX400U	COMPUTER	DVI-I analog	DVI-I EDID1	DVI-I EDID2	HDMI			
NTSC/NTSC4.43/ PAL-M/PAL60	720 x 480i	15.7	59.9	-	A	A						V/S		
PAL/PAL-N/SECAM	720 x 576i	15.6	50.0	-	A	A								
525i(480i)	720 x 480i	15.7	59.9	13.5	A	A						C/Y		
625i(576i)	720 x 576i	15.6	50.0	13.5	A	A								
525p(480p)	720 x 483	31.5	59.9	27.0	A	A			○		○	H/D/C/Y		
625p(576p)	720 x 576	31.3	50.0	27.0	A	A			○		○			
1125(1080)/60i	1920 x 1080i	33.8	60.0	74.3	A	A			○		○			
1125(1080)/50i	1920 x 1080i	28.1	50.0	74.3	A	A			○		○			
1920×1080	1920×1080	66.6	59.9	138.5	A	A						C		
		55.6	49.9	141.5	A	A								
1125(1080)/60p	1920 x 1080p	67.5	60.0	148.5	A	A			○		○	H/D/C/Y		
1125(1080)/50p	1920 x 1080p	56.3	50.0	148.5	A	A			○		○			
750(720)/60p	1280 x 720	45.0	60.0	74.3	AA	A			○		○			
750(720)/50p	1280 x 720	37.5	50.0	74.3	AA	A			○		○			
VESA	640 x 400	31.5	70.1	25.2	A	A						C		
		37.9	85.1	31.5	A	A								
VGA	640 x 480	31.5	59.9	25.2	A	A	○	○			○	○	H/D/C	
		35.0	66.7	30.2	A	A	○	○					C	
		37.9	72.8	31.5	A	A	○	○						
		37.5	75.0	31.5	A	A	○	○						
SVGA	800 x 600	43.3	85.0	36.0	A	A							C	
		35.2	56.3	36.0	A	A	○	○						
		37.9	60.3	40.0	A	A	○	○			○	○		H/D/C
		48.1	72.2	50.0	A	A	○	○						
MAC	832 x 624	46.9	75.0	49.5	A	A	○	○					C	
		53.7	85.1	56.3	A	A								
		49.7	74.6	57.3	A	A	○	○						
		39.6	50.1	51.9	A	AA								
XGA	1024 x 768	48.4	60.0	65.0	A	AA	○	○			○	○	H/D/C	
		56.5	70.1	75.0	A	AA	○	○			○	○		
		60.0	75.0	78.8	A	AA	○	○			○	○		
		68.7	85.0	94.5	A	AA								
MXGA	1152 x 864	64.0	71.2	94.2	A	A	○	○					C	
		67.5	74.9	108.0	A	A								
		76.7	85.0	121.5	A	A								
MAC	1152 x 870	68.7	75.1	100.0	A	A	○	○						
MSXGA	1280 x 960	60.0	60.0	108.0	A	A	○	○						

*1 : "i" added to the resolution value indicates an interlaced signal.

*2 : Picture quality is indicated by the following symbols.

AA: Maximum picture quality can be obtained.

A: Signals are converted by the image processing circuit.

Technical Information

Mode	Display resolution *1 (dots)	Scanning frequency		Dot clock frequency (MHz)	Picture quality *2		PnP					Format
		H (kHz)	V (Hz)		PT-FW430U	PT-FX400U	COMPUTER	DVI-I analog	DVI-I EDID1	DVI-I EDID2	HDMI	
SXGA	1280 x 1024	64.0	60.0	108.0	A	A				○	○	H/D/C
		80.0	75.0	135.0	A	A	○	○				C
		91.1	85.0	157.5	A	A						
SXGA60+	1400 x 1050	64.0	60.0	108.0	A	A						H/D/C
		65.1	59.9	122.4	A	A	○	○		○	○	
UXGA	1600 x 1200	75.0	60.0	162.0	A	A	○	○				C
WIDE750(720)	1280 x 720	44.8	59.9	74.5	AA	A	○	○				
		37.1	49.8	60.5	AA	A						
WXGA768	1280 x 768	39.6	49.9	65.3	AA	A						H/D/C
		47.8	59.9	79.5	AA	A	○	○		○	○	
WXGA800	1280 x 800	41.3	50.0	68.0	AA	A						C
		49.1	60.2	69.1	AA	A						H/D/C
		49.7	59.8	83.5	AA	A	○	○		○	○	
WXGA+	1440 x 900	55.9	59.9	106.5	A	A	○	○				C
WSXGA+	1680 x 1050	65.3	60.0	146.3	A	A	○	○				
WUXGA	1920 x 1200	74.0	59.9	154.0	A	A						

*1 : “i” added to the resolution value indicates an interlaced signal.

*2 : Picture quality is indicated by the following symbols.

AA: Maximum picture quality can be obtained.

A: Signals are converted by the image processing circuit.

Note

- The number of display dots is 1280 x 800 for the PT-FW430U and 1024 x 768 for the PT-FX400U. A signal with a different resolution will be projected after converting the resolution to match the projector display.
- When interlaced signals are connected, flicker may occur on the projected image.

Restoring the MENU LOCK PASSWORD to default

To initialize your password, consult your distributor.

Specifications

Model No.		PT-FW430U	PT-FX400U
Power supply		AC100 V - 240 V 50 Hz/60 Hz	
Power consumption		100 V - 240 V 3.9 A-1.4 A 330 W	
		When [STANDBY MODE] of [ECO MANAGEMENT] is set to [ECO]: 0.3 W (100 V - 120 V), 0.4 W (220 V - 240 V) When [STANDBY MODE] of [ECO MANAGEMENT] is set to [NORMAL]: 9 W When [STANDBY MODE] of [AUDIO SETTING] is set to [ON]: 20 W	
LCD panel	Panel size	1.89 cm(0.74") (aspect ratio 16 : 10)	2.03 cm(0.8") (aspect ratio 4 : 3)
	Display method	3 transparent LCD panels (RGB)	
	Drive method	Active matrix method	
	Pixels	1 024 000 (1 280 x 800) x 3 panels	786 432 (1 024 x 768) x 3 panels
Lens		Manual zoom (2x) / Manual focus F 1.7 to 2.6, f 21.6 mm to 43.0 mm	Manual zoom (2x) / Manual focus F 1.7 to 2.6, f 24.0 mm to 47.2 mm
Luminous lamp		250 W UHM lamp	
Light output *1		3500 lm	4000 lm
Applicable scanning frequency *2	for RGB signal	Horizontal 15.6 kHz to 91.1 kHz, Vertical 24 Hz to 85.1 Hz PIAS (Panasonic Intelligent Auto Scanning) system	
	for YPbPr signal	Dot clock frequency: 162 MHz or less	
	for Video signal (including S-Video)	Horizontal 15.75 kHz / 15.63 kHz, Vertical 50 Hz / 60 Hz	
	for DVI-D / HDMI signal	525p(480p), 625p(576p), 750(720)/60p, 750(720)/50p, 1125(1080)/60p, 1125(1080)/50p, 1125(1080)/60i, 1125(1080)/50i, 1125(1080)/24p ● Displayable resolution: VGA to WUXGA (non-interlace) ● Dot clock frequency: 25.2 MHz to 148.5 MHz	
Color system		7 (NTSC, NTSC4.43, PAL, PAL-N, PAL-M, SECAM, PAL 60)	
Projection size		0.84 m-7.62 m(33"-300")	
Screen aspect ratio		16 : 10	4 : 3
Projection scheme		Front / Rear / Mount on Ceiling / Floor (Menu setting system)	
Speaker		1 (4 cm round-type)	
Maximum usable volume output		5 W	
Contrast ratio *1		600 : 1 (all white / all black)	

*1 : Measurement, measuring conditions and method of notation all comply with ISO21118 international standards.

*2 : For details of video signals that can be projected using this projector, refer to "List of compatible signals".
(▶ page 83)

Specifications

Model No.		PT-FW430U	PT-FX400U
Terminals	COMPUTER IN	1 (D-sub 15 pin female) [RGB signal] 0.7 V [p-p] 75 Ω (When G-SYNC: 1.0 [p-p] 75 Ω HD/SYNC TTL high impedance, automatic positive/negative polarity compatible VD TTL high impedance, automatic positive/negative polarity compatible [YPbPr signal] Y: 1.0 V [p-p] including synchronization signal, PbPr: 0.7 V [p-p] 75 Ω	
	DVI-I IN	1 (DVI-I 29 pin) [DIGITAL signal] Single link, DVI 1.0 compliant, HDCP compatible [RGB signal] 0.7 V [p-p] 75 Ω (When G-SYNC: 1.0 [p-p] 75 Ω HD/SYNC TTL high impedance, automatic positive/negative polarity compatible VD TTL high impedance, automatic positive/negative polarity compatible [YPbPr signal] Y: 1.0 V [p-p] including synchronization signal, PbPr: 0.7 V [p-p] 75 Ω	
	VIDEO IN	1 (RCA pin jack 1.0 V [p-p] 75 Ω)	
	S-VIDEO IN	1 (Mini DIN 4 pin, Y 1.0 V [p-p], C 0.286 V [p-p] 75 Ω, S1 signal compatible)	
	HDMI IN	1 (HDMI 19 pin, HDCP and Deep color compatible)	
	SERIAL IN	1 (D-sub 9 pin, RS-232C compliant, for computer control use)	
	AUDIO IN	2 (M3 stereo mini jack, 0.5 V [rms], input impedance 22 kΩ and more) 1 (RCA pin jack x 2 (L-R), 0.5 V [rms], input impedance 22 kΩ and more)	
	AUDIO OUT	1 (M3 stereo mini jack, stereo monitor output compatible, 0 V [rms] to 2.0 V [rms] valuable, output impedance 2.2 kΩ and less)	
	LAN	1 (for RJ-45 network connection, PLink compatible, 10Base-T/100Base-TX)	
	WIRELESS MODULE connection	1 (only for the Wireless module; ET-WM200U, optional)	
Power cable length		2.0 m(78 3/4")	
Cabinet		Molded plastic	
Dimensions		Width: 430 mm (16 7/8") Height: 125.5 mm (5") (when front adjustable feet shortened) Depth: 323 mm (12 3/4") (excluding protractions)	
Weight		Approx.6.0 kg(13.2 lbs.) *3	
Operating environment		Operating environment temperature *4 : 0 °C (32 °F) to 40 °C (104 °F) Operating environment humidity: 20 % to 80 % (no condensation)	
Remote control	Power supply	DC 3 V (battery (AA/R6/LR6 type) x 2)	
	Operating range	Approx. 15 m (49'2") (when operated directly in front of receptor)	
	Weight	117 g (4.2 ozs.) (including batteries)	
	Dimensions	Width : 48 mm (1 7/8"), Length : 163 mm (6 13/32"), Height : 24.5 mm (15/16")	

*3 : This is an average value. It may differ depending on individual product.

*4 : When using this projector at high elevation 1400 m (4593 ft) to 2700 m (8858 ft) sea level, the operating environment temperature will be 0 °C (32 °F) to 35 °C (95 °F).

- The part numbers of accessories and separately sold components are subject to change without notice.

Dimensions

<Unit : mm>

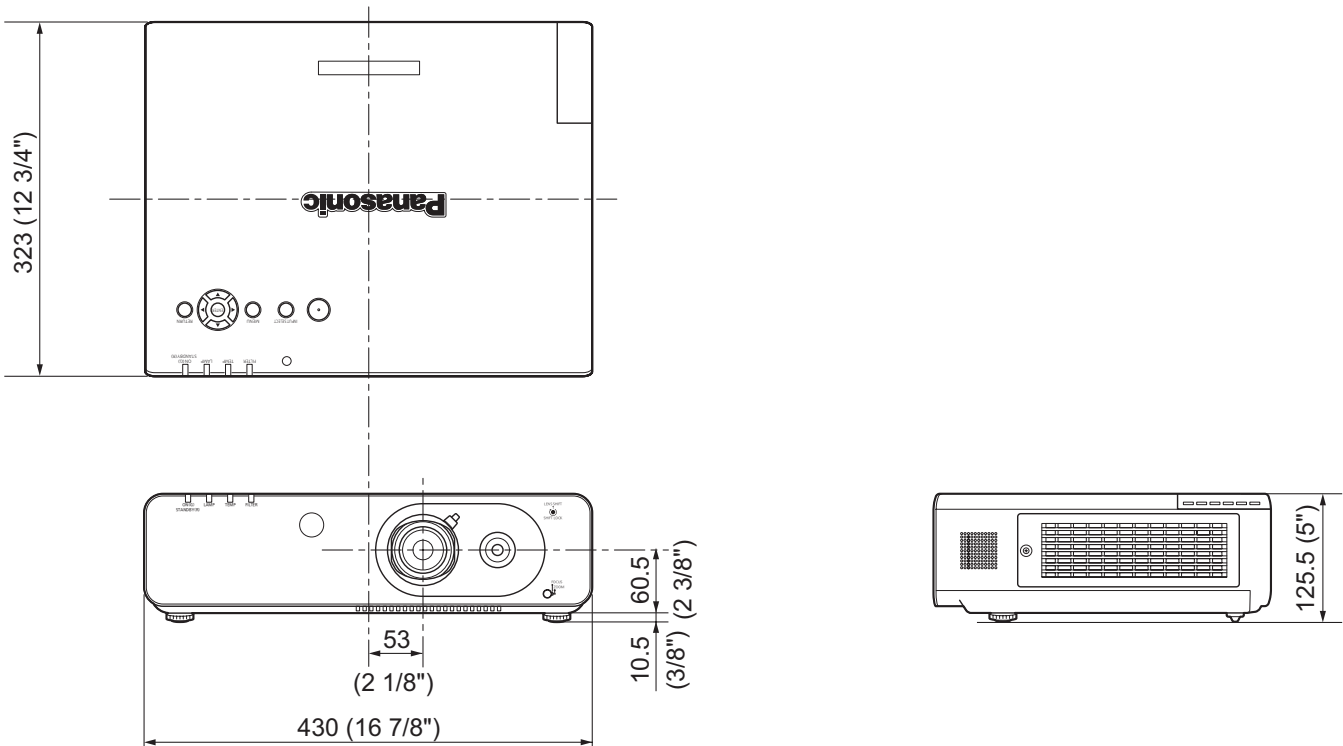

*: Actual dimension may differ by product.

Ceiling mount bracket safeguards

- Installation work of the ceiling mount bracket should only be carried by a qualified technician.
- Even if it is during guaranteed period, the manufacturer is not responsible for any hazard or damage caused by using a ceiling mount bracket which is not purchased from an authorized distributors, or environmental conditions.
- Ask authorized personnel to promptly remove any products that are no longer used.
- Use a torque screwdriver or Allen torque wrench to tighten bolts to their specified tightening torques. Power screwdrivers or impact screwdrivers must not be used.
- For details, see the work instruction manual packed together with the ceiling mount bracket.
- The model Nos. of the accessories and the parts sold separately are subject to change without notice.

Bottom view

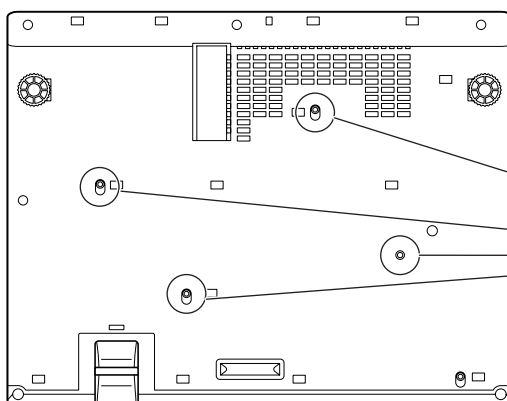

Model No. of ceiling mount bracket:

ET-PKF110H (for high ceilings)

ET-PKF110S (for low ceilings)

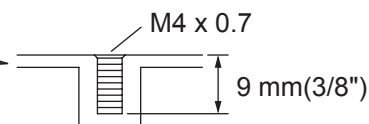

Torque: 1.25 ± 0.2 N.m

Index

A			
Accessories	15	I	
ADVANCED MENU	40	ID numbers	20, 56
Air filter	70, 71	INDEX WINDOW	54
ASPECT	44	INITIALIZE	63
AUDIO SETTING	61	INITIALIZE ALL	63
AUTO POWER SAVE	59	INITIAL SETTING	16
AUTO SETUP	33, 52, 54	INITIAL START UP	56
AV MUTE function	32, 54	INPUT GUIDE	49
		Installing batteries	20
B		K	
BACK COLOR	53	KEYSTONE	42
Basic operations using the remote control	32	L	
BRIGHTNESS	38	LAMP indicator	68
		LAMP POWER	57
C		Lamp unit	72, 73
Cautions on use	14	LANGUAGE menu	48
Cautions when installing	12	Lens shift function	24
Cautions when transporting	12	List of compatible signals	83
CD-ROM	15	M	
Changing the display language	48	MAIN MENU	36
CLOCK PHASE	43	Maintenance	70
CLOSED CAPTION SETTING	51	Managing the indicated problems	68
COLOR	39	MENU LOCK	65
COLOR TEMPERATURE	39	MENU LOCK PASSWORD	65
Connecting	27	Menu Navigation	35
Connecting the power cord	28	N	
CONTRAST	38	Navigating through the menu	35
CONTROL DEVICE SETUP	66	NETWORK menu	67
CONTROL PANEL	19	NOISE REDUCTION	41
		NO SIGNAL SHUT-OFF	59
D		O	
DATE AND TIME	62	ON SCREEN DISPLAY	49
DAYLIGHT VIEW	40	Operating environment	86
DEFAULT button	33	Optional accessories	15
DIGITAL CINEMA REALITY	40	OSD DESIGN	49
DIGITAL ZOOM	55	Other terminals	80
Direct power off function	30	OVER SCAN	43
DISPLAY OPTION menu	49	P	
DISPLAY SETTING	65	PASSWORD	64
Disposal	13	PASSWORD CHANGE	64
DOT CLOCK	43	PICTURE menu	38
DVI-I IN	50	PICTURE MODE	38
		POSITION menu	42
E		Power indicator	28
ECO button	33	Powering off the projector	30
ECO MANAGEMENT	59	Powering up the projector	29
EMULATE	60	Precautions for Use	12
		Projecting	31
F		Projection distance	22, 23
FILTER indicator	69	PROJECTION METHOD	21, 57
FRAME LOCK	47	Projector body	18
FREEZE	54	PROJECTOR ID	56
FREEZE function	32	PROJECTOR SETUP menu	56
Front adjustable feet	24		
FUNCTION BUTTON	60	R	
Function buttons	33	Read this first	2
		Rear terminals	19
H		Remote control	17
HDMI IN	50	Removing batteries	20
HIGH ALTITUDE MODE	57		
How to adjust the state of the image	31	Replacing the unit	71
		Resetting to the factory default	33, 35
		RGB/YPbPr	41
		S	
		SCHEDULE	58
		SCREEN SETTING	51
		Screen size and throw distance	22
		Security	13
		SECURITY menu	64
		Selecting the image	31
		Serial terminal	77
		Setting Remote control ID numbers	20
		Setting up	21
		SHARPNESS	39
		SHIFT	42
		SHIFT V	42
		SIDE BY SIDE	55, 82
		SIGNAL SEARCH	53
		Specifications	85
		STANDBY MODE	59
		STARTUP LOGO	52
		STATUS	56
		SUB MENU	36
		Switching the input signal	32
		SXGA MODE	53
		T	
		TEMP indicator	69
		TEST PATTERN	63
		TEXT CHANGE	65
		TINT	39
		Troubleshooting	75
		TV-SYSTEM	41
		V	
		VOLUME	34
		W	
		WARNING MESSAGE	49
		WIDE MODE	53
		Wireless Module	74

Information on Disposal in other Countries outside the European Union



These symbols are only valid in the European Union.

If you wish to discard this product, please contact your local authorities or dealer and ask for the correct method of disposal.



EU



Panasonic Corporation

Web Site : <http://panasonic.net/avc/projector/>

Panasonic Solutions Company

3 Panasonic Way, Secaucus, NJ 07094

TEL: (877) 803 - 8492

Panasonic Canada Inc.

5770 Ambler Drive, Mississauga, Ontario L4W 2T3

TEL: (905) 624 - 5010