

Operating Instructions

LCD Projector Commercial Use

Model No. **PT-LB90NTU**
PT-LB90U
PT-LB78VU
PT-LB75VU

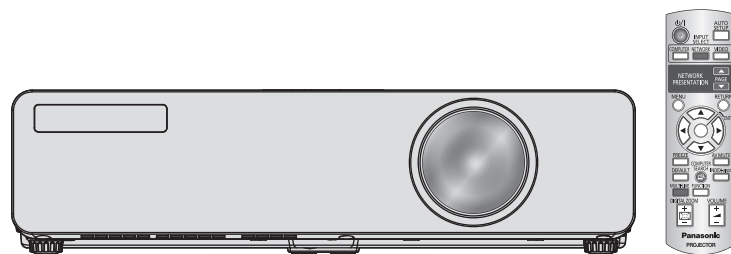

Thank you for purchasing a Panasonic Projector.

■ Before operating this product, please read the instructions carefully, and save this manual for future use.

Before using your projector, be sure to read “Precautions with regard to safety” (pages 6 - 10).

Important Safety Notice

Dear Panasonic Customer:

The following information should be read and understood as it provides details, which will enable you to operate the projector in a manner which is both safe to you and your environment, and conforms to legal requirements regarding the use of projectors. Before connecting, operating or adjusting this projector, please read these instructions completely and save this booklet with the projector for future reference. We hope it will help you to get the most out of your new product, and that you will be pleased with your Panasonic LCD projector.

The serial number of your product may be found on its bottom. You should note it in the space provided below and retain this booklet in case service is required.

Model number: PT-LB90NTU/PT-LB90U/PT-LB78VU/PT-LB75VU

Serial number:

WARNING: TO REDUCE THE RISK OF FIRE OR ELECTRIC SHOCK, DONOT EXPOSE THIS PRODUCT TO RAIN OR MOISTURE.

Power Supply: This LCD Projector is designed to operate on 100 V - 240 V, 50 Hz/60 Hz AC, house current only.

CAUTION: The AC power cord which is supplied with the projector as an accessory can only be used for power supplies up to 125 V, 7 A. If you need to use higher voltages or currents than this, you will need to obtain a separate 250 V power cord. If you use the accessory cord in such situations, fire may result.

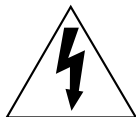

The lightning flash with arrowhead symbol, within an equilateral triangle, is intended to alert the user to the presence of uninsulated "dangerous voltage" within the product's enclosure that may be of sufficient magnitude to constitute a risk of electric shock to persons.



The exclamation point within an equilateral triangle is intended to alert the user to the presence of important operating and maintenance (servicing) instructions in the literature accompanying the product.

CAUTION: This equipment is equipped with a three-pin grounding-type power plug. Do not remove the grounding pin on the power plug. This plug will only fit a grounding-type power outlet. This is a safety feature. If you are unable to insert the plug into the outlet, contact an electrician. Do not defeat the purpose of the grounding plug.

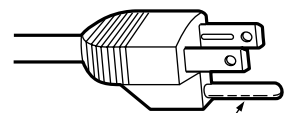

Do not remove

Pursuant to at the directive 2004/108/EC, article 9(2)
Pursuant to at the directive 2005/32/EC amended by 2008/28/EC, article 14
Panasonic Testing Center
Panasonic Service Europe, a division of Panasonic Marketing Europe GmbH
Winsbergring 15, 22525 Hamburg, F.R. Germany

NOTICE:

- This product has a High Intensity Discharge (HID) lamp that contains mercury. Dispose may be regulated in your community due to environmental considerations. For disposal or recycling information, please contact your local authorities, or the Electronic Industries Alliance: <http://www.eiae.org>

WARNING:

This equipment has been tested and found to comply with the limits for a Class B digital device, pursuant to Part 15 of the FCC Rules. These limits are designed to provide reasonable protection against harmful interference in a residential installation. This equipment generates, uses and can radiate radio frequency energy and, if not installed and used in accordance with the instructions, may cause harmful interference to radio communications. However, there is no guarantee that interference will not occur in a particular installation. If this equipment does cause harmful interference to radio or television reception, which can be determined by turning the equipment off and on, the user is encouraged to try to correct the interference by one or more of the following measures:

- Reorient or relocate the receiving antenna.
- Increase the separation between the equipment and receiver.
- Connect the equipment into an outlet on a circuit different from that to which the receiver is connected.
- Consult the dealer or an experienced radio/TV technician for help.

FCC CAUTION: To assure continued compliance, follow the attached installation instructions and use only shielded interface cables when connecting to computer and/or peripheral devices. Any changes or modifications not expressly approved by Panasonic Corp. of North America could void the user's authority to operate this device.

FCC RF Exposure Warning: (if provided with wireless device)

- This equipment complied with FCC radiation exposure limits set forth for an uncontrolled environment.
- This equipment has been approved for mobile operation and requires minimum 20 cm spacing be provided between antenna(s) and all person's body (excluding extremities of hands, wrist and feet) during wireless modes of operation.
- This equipment may not be used with other installed transmitters, which may be capable of simultaneous transmission.

WARNING:

- Not for use in a computer room as defined in the Standard for the Protection of Electronic Computer/Data Processing Equipment, ANSI/NFPA 75.
- For permanently connected equipment, a readily accessible disconnect device shall be incorporated in the building installation wiring.
- For pluggable equipment, the socket-outlet shall be installed near the equipment and shall be easily accessible.

Declaration of Conformity

Model Number: PT-LB90NTU/PT-LB90U/PT-LB78VU/PT-LB75VU
Trade Name: **Panasonic**
Responsible party: Panasonic Corporation of North America
Address: One Panasonic Way, Secaucus, New Jersey 07094
Telephone number: (888) 411 - 1996
E-mail: projectorsupport@us.panasonic.com

This device complies with Part 15 of the FCC Rules. Operation is subject to the following two conditions: (1) This device may not cause harmful interference, and (2) this device must accept any interference received, including interference that may cause undesired operation.

Information on Disposal in other Countries outside the European



These symbols are only valid in the European Union.
If you wish to discard this product, please contact your local authorities or dealer and ask for the correct method of disposal.



Environment care information for users in China



This symbol is only valid in China.

User logo display function

You can project your unique image such as your company's logo when projection starts. (➡page 37)

FUNCTION button

You can assign almost all the items on the on-screen menu to the **FUNCTION** button of the remote control and control panel. You can display the frequently used functions by pressing the **FUNCTION** button. (➡page 26, 41)

Standby power reduction

The standby power is highly reduced from the previous model.

Approx. 4.0 W (PT-LB80NTU)



Approx. 0.9 W (PT-LB90NTU)
(Standby mode: In "ECO")

Quick steps

For details, see the corresponding pages.

1. **Set up your projector.**
(➡page 15)



2. **Connect with other devices.**
(➡page 17)



3. **Connect the power cord.**
(➡page 19)



4. **Switch on the projector.**
(➡page 21)



5. **Select the input signal.**
(➡page 23)



6. **Adjust the image.**
(➡page 23)

Contents

Important Information

Important Safety Notice	2
Precautions with regard to safety	6
WARNING	6
CAUTION	7
Cautions when transporting	8
Cautions when installing	8
Cautions on use	9
Security	9
Cleaning and maintenance	9
Disposal	9
Accessories	10

Preparation

Read this first	11
About Your Projector	12
Projector body	12
Remote control	14

Getting Started

Setting up	15
Screen size and throw distance	15
Projection method	16
Front leg adjusters and throwing angle	16
Connections	17
Before connecting to the projector	17
Connecting example: AV equipment	17
Connecting example: Computers	18

Basic Operation

Switching the projector on/off	19
Power cord	19
POWER and POWER LOCK indicators	20
Switching on the projector	21
Switching off the projector	22
Projecting an image	23
Selecting the input signal	23
Positioning the image	23
Remote control operation	24
Capturing an image	24
Stopping the projection temporarily	24
Switching the input signal	24
Setting up the image position automatically	25
Resetting to the factory default settings	25
Controlling the volume of the speaker	25
Projecting an image in INDEX-WINDOW mode	25
Enlarging the image	26
Using an assigned function	26

Settings

Menu Navigation	27
Navigating through the MENU	27
ON-SCREEN MENU	28
Main menu	28
Sub-menu	28
PICTURE menu	30
PICTURE MODE	30
CONTRAST	30
BRIGHTNESS.....	30
COLOR	30
TINT	30
SHARPNESS.....	30
WHITE BALANCE.....	30
COLOR TEMPERATURE	30
DAYLIGHT VIEW	31
STILL MODE.....	31
NOISE REDUCTION	31
TV-SYSTEM.....	31
RGB/YP _B PR.....	31
POSITION menu	32
REALTIME KEYSTONE.....	32
KEYSTONE	32
SHIFT.....	32
SHIFT V	32
DOT CLOCK	32
CLOCK PHASE	32
OVER SCAN.....	33
ASPECT.....	33
FRAME LOCK.....	34
LANGUAGE menu	35
DISPLAY OPTION menu	36
ON-SCREEN DISPLAY	36
CLOSED CAPTION SETTING.....	36
STARTUP LOGO	37
AUTO SETUP	37
SIGNAL SEARCH.....	37
BACK COLOR	37
WIDE MODE.....	38
SXGA MODE	38
OTHER FUNCTIONS	38
PROJECTOR SETUP menu	39
STATUS	39
NO SIGNAL SHUT-OFF	39
INITIAL START UP.....	39
INSTALLATION	39
HIGH ALTITUDE MODE	39
STANDBY MODE	40
LAMP POWER.....	40
LAMP RUNTIME.....	40
EMULATE	40

FUNCTION BUTTON.....	41
AUDIO SETTING	41
TEST PATTERN.....	42
INITIALIZE ALL	42
SECURITY menu	43
PASSWORD	43
PASSWORD CHANGE	43
TEXT DISPLAY	43
TEXT CHANGE	43
MENU LOCK.....	44
MENU LOCK PASSWORD.....	44
CONTROL DEVICE SETUP	44
NETWORK menu (PT-LB90NTU only)	45

Maintenance

LAMP and TEMP Indicators	46
Managing the indicated problems	46
Care and Replacement	47
Before Care and Replacement	47
Cleaning the projector.....	47
Replacing the Lamp unit	48
Troubleshooting	51

Appendix

Technical Information	52
List of compatible signals.....	52
Serial terminal	53
LAN terminal	54
MENU LOCK PASSWORD.....	54
Specifications	55
Ceiling mount bracket safeguards	57
Dimensions	58
Trademark acknowledgements	58
Index	59

Informations importantes

Avis important concernant la sécurité ..	60
Précautions de sécurité	62
AVERTISSEMENT	62
MISE EN GARDE	63
Précautions lors du transport.....	64
Précautions lors de l'installation.....	64
Précautions lors de l'utilisation.....	65
Sécurité.....	65
Nettoyage et entretien.....	65
Mise au rebut	65
Remplacement de l'unité de la lampe	66

Precautions with regard to safety

WARNING

■ POWER

The wall outlet or the circuit breaker shall be installed near the equipment and shall be easily accessible when problems occur. If the followings problems occur, cut off the power supply immediately.

Continued use of the projector in these conditions will result in fire or electric shock.

- If foreign objects or water get inside the projector, cut off the power supply.
- If the projector is dropped or the cabinet is broken, cut off the power supply.
- If you notice smoke, strange smells or noise coming from the projector, cut off the power supply.

Please contact an Authorized Service Center for repairs, and do not attempt to repair the projector yourself.

During a thunderstorm, do not touch the projector or the cable.

Electric shocks can result.

Do not do anything that might damage the power cord or the power plug.

If the power cord is used while damaged, electric shocks, short-circuits or fire will result.

- Do not damage the power cord, make any modifications to it, place it near any hot objects, bend it excessively, twist it, pull it, place heavy objects on top of it or wrap it into a bundle.

Ask an Authorized Service Center to carry out any repairs to the power cord that might be necessary.

Insert the power plug securely into the wall outlet.

If the plug is not inserted correctly, electric shocks or overheating will result.

- Do not use anything other than the provided power cord.
- Do not use plugs which are damaged or wall outlets which are coming loose from the wall.

Clean the power plug regularly to prevent it from becoming covered in dust.

Failure to observe this will cause a fire.

- If dust builds up on the power plug, the resulting humidity can damage the insulation.
- If not using the projector for an extended period of time, pull the power plug out from the wall outlet.

Pull the power plug out from the wall outlet and wipe it with a dry cloth regularly.

Do not handle the power plug with wet hands.

Failure to observe this will result in electric shocks.

Do not overload the wall outlet.

If the power supply is overloaded (ex., by using too many adapters), overheating may occur and fire will result.

■ ON USE/INSTALLATION

Do not place liquid containers on top of the projector.

If water spills onto the projector or gets inside it, fire or electric shocks will result.

If any water gets inside the projector, contact an Authorized Service Center.

Do not place the projector on soft materials such as carpets or sponge mats.

Doing so will cause the projector to overheat, which can cause burns, fire or damage to the projector.

Do not set up the projector in humid or dusty places or in places where the projector may come into contact with oily smoke or steam, ex a bathroom.

Using the projector under such conditions will result in fire, electric shocks or components deterioration. Components deterioration (such as ceiling mount brackets) may cause the projector which is mounted on the ceiling to fall down.

Do not install this projector in a place which is not strong enough to take the full weight of the projector or on top of a surface which is sloped or unstable.

Failure to observe this will cause projector to fall down or tip over the projector, and severe injury or damage could result.

Do not place another projector or other heavy objects on top of the projector.

Failure to observe this will cause the projector to become unbalanced and fall, which could result in damage or injury. The projector will be damaged or deformed.

Installation work (such as ceiling suspension) should only be carried out by a qualified technician.

If installation is not carried out and secured correctly it can cause injury or accidents, such as electric shocks.

- Do not use anything other than an Authorized ceiling mount bracket.

Do not cover the air inlet port or the air outlet port.

Doing so will cause the projector to overheat, which can cause fire or damage to the projector.

- Do not place the projector in narrow, badly ventilated places such as closets or bookshelves.
- Do not place the projector on cloth or papers, as these materials could be drawn into the air inlet port.

Do not place your hands or other objects close to the air outlet port.

Doing so will cause burns or damage your hands or other objects.

- Heated air comes out of the air outlet port. Do not place your hands or face, or objects which cannot withstand heat close to this port.

Do not look into or touch the lights emitted from the lens while the projector is being used.

Doing so can cause burns or loss of sight.

- Strong light is emitted from the projector's lens. Do not look or place your hands directly into this light.
- Be especially careful not to let young children look into the lens. In addition, turn off the power and disconnect the power plug when you are away from the projector.

Do not insert any foreign objects into the projector.

Doing so will cause fire or electric shocks.

- Do not insert any metal objects or flammable objects into the projector or drop them onto the projector.

Never attempt to remodel or disassemble the projector.

High voltages can cause fire or electric shocks.

For any inspection, adjustment and repair work, please contact an Authorized Service Center.

■ ACCESSORIES

Do not use or handle the batteries improperly, and refer to the following.

Failure to observe this will cause burns, batteries to leak, overheat, explode or catch fire.

- Do not use unspecified batteries.
- Use manganese batteries or alkaline batteries but not rechargeable batteries.
- Do not disassemble dry cell batteries.
- Do not heat the batteries or place them into water or fire.
- Do not allow the + and – terminals of the batteries to come into contact with metallic objects such as necklaces or hairpins.
- Do not store batteries together with metallic objects.
- Store the batteries in a plastic bag and keep them away from metallic objects.
- Make sure the polarities (+ and –) are correct when inserting the batteries.
- Do not use a new battery together with an old battery or mix different types of batteries.
- Do not use batteries with the outer cover peeling away or removed.
- Remove the empty batteries from the remote control at once.
- Insulate the battery using tape or something similar before disposal.

Do not allow children to reach the batteries.

- The battery can cause death by suffocation if swallowed.
- If swallowed, seek medical advice immediately.

If the battery fluid leaks, do not touch it with bare hands, and take the following measures if necessary.

- Battery fluid on your skin or clothing could result in skin inflammation or injury.
Rinse with clean water and seek medical advice immediately.
- Battery fluid coming in contact with your eyes could result in loss of sight.
In this case, do not rub your eyes. Rinse with clean water and seek medical advice immediately.

Do not disassemble the lamp unit.

If the lamp breaks, it could cause injury.

Lamp replacement

The lamp has high internal pressure. If improperly handled, an explosion and severe injury or accidents will result.

- Replacement of the lamp should be carried out by a qualified technician.
- The lamp can easily explode if struck against hard objects or dropped.
- Before replacing the lamp, be sure to disconnect the power plug from the wall outlet.
Electric shocks or explosions can result if this is not done.
- When replacing the lamp, allow it to cool for at least one hour before handling it otherwise it can cause burns.

Do not allow infants or pets to touch the remote control unit.

- Keep the remote control unit out of the reach of infants and pets after using it.

CAUTION

■ POWER

When disconnecting the power cord, hold the plug, not the lead.

If the power cord itself is pulled, the lead will become damaged, and fire, short-circuits or serious electric shocks will result.

When not using the projector for an extended period of time, disconnect the power plug from the wall outlet and remove the batteries from the remote control.

Disconnect the power plug from the wall outlet before carrying out any cleaning.

Electric shocks can result if this is not done.

Precautions with regard to safety

■ ON USE/INSTALLATION

Do not put your weight on this projector.

You could fall or the projector could break, and injury will result.

- Be especially careful not to let young children stand or sit on the projector.

Do not place the projector in extremely hot locations.

Doing so will cause the outer casing or internal components to deteriorate, or result in fire.

- Take particular care in locations exposed to direct sunlight or near stoves.

Always disconnect all cables before moving the projector.

Moving the projector with cables still attached can damage the cables, which will cause fire or electric shocks to occur.

■ ACCESSORIES

Do not use the old lamp unit.

If used it could cause lamp explosion.

If the lamp has broken, ventilate the room immediately. Do not touch or bring your face close to the broken pieces.

Failure to observe this will cause the user to absorb the gas which was released when the lamp broke and which contains nearly the same amount of mercury as fluorescent lamps, and the broken pieces will cause injury.

If you believe that you have absorbed the gas or that the gas has got into your eyes or mouth, seek medical advice immediately.

Ask your dealer about replacing the lamp unit and check the inside of the projector.

Do not use projectors with the adjustable feet or lens cover removed.

If this not observed, the sets will not operate correctly or accidents will result.

Cautions when transporting

When transporting the projector, the adjuster legs must be housed and do not hold them. Please securely hold only its bottom and none of its other parts or surfaces as this will result in malfunctions.

When transporting, keep the projector in the provided carrying bag.

- Face the lens of the projector in an upward direction and put it gently into the carrying bag.
- Do not put anything other than the projector and its accessories in the carrying bag.

Cautions when installing

Do not use under the following conditions.

- **Do not set up the projector outdoors.**
The projector is designed for indoor use only.
- **Avoid setting up in places which are subject to vibration or shocks.**
If the projector is installed in a place where vibrations are transmitted or mounted in a car or a vessel, vibrations or impacts will result in damage to the internal parts, causing failure. Install the product in a place free from vibrations and impacts.
- **Avoid setting up in places which are subject to sudden temperature changes, such as near an air conditioner or lighting equipment.**
Failure to observe this will result in malfunctions or the lamp life will be shortened.
See "TEMP indicator" on page 46.
- **Avoid setting up in places which are near high-voltage power lines or near motors.**
The product will be exposed to interference if it is installed in the vicinity of high-voltage electrical power lines or power sources.
- **Do not install the projector at elevations higher than 2 700 m (8 858 ft) above sea level.**
If using this projector at high elevations 1 400 - 2 700 m (4 593 - 8 858 ft) above sea level, set the **HIGH ALTITUDE MODE** to **ON**.
Failure to observe this will result in malfunctions or the lamp life or life of other components will be shortened.

Be sure to ask a specialised technician when installing the product to a ceiling.

If the product is to be installed hanging from the ceiling, purchase an optional hanging attachment (Model No. ET-PKB80). Please call a specialised technician or contact an Authorized Service Center for installation.

Lens Focus

Do not adjust the lens focus in the initial period after switching the projector on. The high clarity projector lens is thermally affected by the light from the light source, making the focus unstable in the period just after switching on. Please allow a warm-up time of at least 30 minutes before adjusting the lens focus.

Cautions on use

■ In order to get the picture quality

Draw curtains or blinds over windows and turn off any lights near the screen to prevent outside light or light from indoor lamps from shining onto the screen. Depending on where the projector is used, air exhaust vents or the warm air from air conditioning can cause a shimmering effect on the screen. For this reason, take care not to shield the air exhaust vents and consider the direction of the air flowing from air conditioning.

■ Do not touch the surface of the projector lens cover with your bare hand.

If the surface of the lens becomes dirty from fingerprints or anything else, this will be magnified and projected onto the screen.

■ Do not move the projector while it is operating or subject it to vibration or impact.

The service life of its internal components will be shortened.

■ The projector has a high pressure mercury lamp that is characterized as follows:

- The brightness of the lamp will decrease over time.
- The lamp may explode or shorten the lamp life by shocks or chipping damage.
- In rare cases, it may burst shortly after the first use.
- The possibility of its bursting increases when the lamp is used beyond the replacement time.
- If the lamp bursts, gas inside the lamp is released in the form of smoke.
- The life of a mercury lamp varies according to the individual difference or conditions of use.
- In particular, turning the power on and off frequently and/or repeatedly as well as continuous use for 10 hours will greatly affect the life cycle. Provide a lamp for replacement in advance.

■ Connection to external device

When connecting the projector to a computer or external device, use the power cord supplied with the corresponding device and a commercially available shielded interface cable.

■ Optical components

It may be necessary to replace the optical components such as Liquid crystal panels and Polarizing plates in less than 1 year if using the projector in a high temperature environment or in a very dusty, oily smoke or tobacco smoke environment. For more details, please contact your dealer.

■ Liquid crystal panel

The Liquid crystal panels are precision-made. Note that in rare cases, pixels of high precision could be missing or always lit, but this is not a malfunction. Do not project the same image for long periods of time, as this may remain as an afterimage on the liquid crystal panel. Display the white screen test pattern for more than an hour to remove it. See "TEST PATTERN" on page 42.

Security

■ Take safety measures against following incidents.

- Personal information being leaked via this product.
- Unauthorized operation of this product by a malicious third party.
- Interfering or stopping of this product by a malicious third party.

■ Security instruction

- The connecting network must be secured by firewall or others.
- Change your password regularly.
- Do not use a password that is simple to guess.
- Panasonic and its affiliate companies would never directly inquire about your password.
- Do not share your password with the general public.
- Set a password, and place restrictions on the users who can log in.

Cleaning and maintenance

■ Ask an Authorized Service Center to clean the inside of the projector at least once a year.

If dust is left to build up inside the projector without being cleaned out, it can result in fire or problems with operation. It is a good idea to clean the inside of the projector before the season when humid weather arrives.

Ask your nearest Authorized Service Center to clean the projector when required.

Please discuss with the Authorized Service Center regarding cleaning costs.





Disposal

When discarding this product, please contact your local authorities or dealer and ask for the correct method of disposal.

Precautions with regard to safety

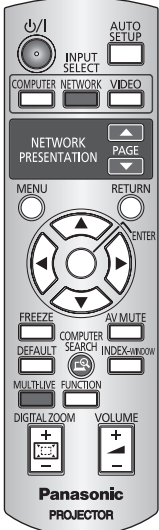
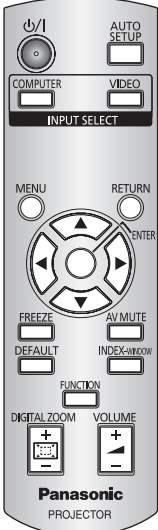
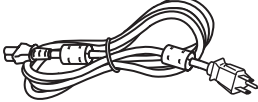
Accessories

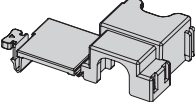
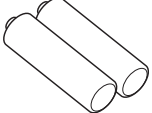
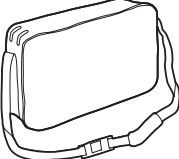
Make sure the following accessories are provided with your projector.

<p>Remote control for PT-LB90NTU (×1) (N2QAYB000436)</p> 	<p>Remote control for PT-LB90U/LB78VU/ LB75VU (×1) (N2QAYB000262)</p> 	<p>Power cord (×1) (K2CG3DR00008)</p> 	<p>RGB signal cable (×1) 1.8 m (5'10") (K1HA15DA0002)</p> 
		<p>Power cord secure lock (×1) (TTRA0185)</p> 	<p>AA batteries for Remote control (×2)</p> 
		<p>Carrying bag (×1) (TPEP021)</p> 	<p>CD-ROM (×1) (TXFQB02VKJ2)</p>  <p>(PT-LB90NTU only)</p>

Note

- The protectors for enclosed products, such as a plug cover or foam cartons, must be treated properly.
- Contact to an Authorized Service Center for lost accessories.

Read this first

When you start the projection for the first time or after the projector is initialised (▶page 42), the **LANGUAGE** menu and the **INITIAL SETTING** menu will be displayed.

Set those menus according to the usage conditions and environment.

The setting can be changed by navigating through the ON SCREEN MENU.

■ LANGUAGE

Select the required language setting. (▶page 35)

- 1) Press **▲▼◀▶** buttons of the remote control or control panel on the projector to highlight the required language.



- 2) Press the **ENTER** button to proceed to the next **INITIAL SETTING** menu.

■ INITIAL SETTING

Select the required setting of **INSTALLATION** and **HIGH ALTITUDE MODE**.

- 1) Press **▲▼** buttons to select the required menu.
- 2) Press **◀▶** buttons to change the settings of **INSTALLATION** or **HIGH ALTITUDE MODE**.

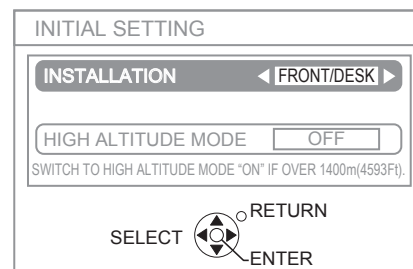

- **INSTALLATION** (▶page 16, 39)

FRONT/DESK	Setting on a desk/floor and projecting from front
FRONT/CEILING	Mounting in the ceiling with a ceiling mount bracket (sold separately) and projecting from front
REAR/DESK	Setting on a desk/floor and projecting from rear (Translucent screen is required)
REAR/CEILING	Mounting in the ceiling with a ceiling mount bracket (sold separately) and projecting from rear (Translucent screen is required)

- **HIGH ALTITUDE MODE** (▶page 8, 39)

OFF	For use in normal environment
ON	For use at high altitude (above 1 400 m (4 593 ft))

- 3) Press the **ENTER** button to finish.

Remarks

- To return to the **LANGUAGE** menu, press the **RETURN** button in the **INITIAL SETTING** menu.

About Your Projector

Projector body

Top and front view

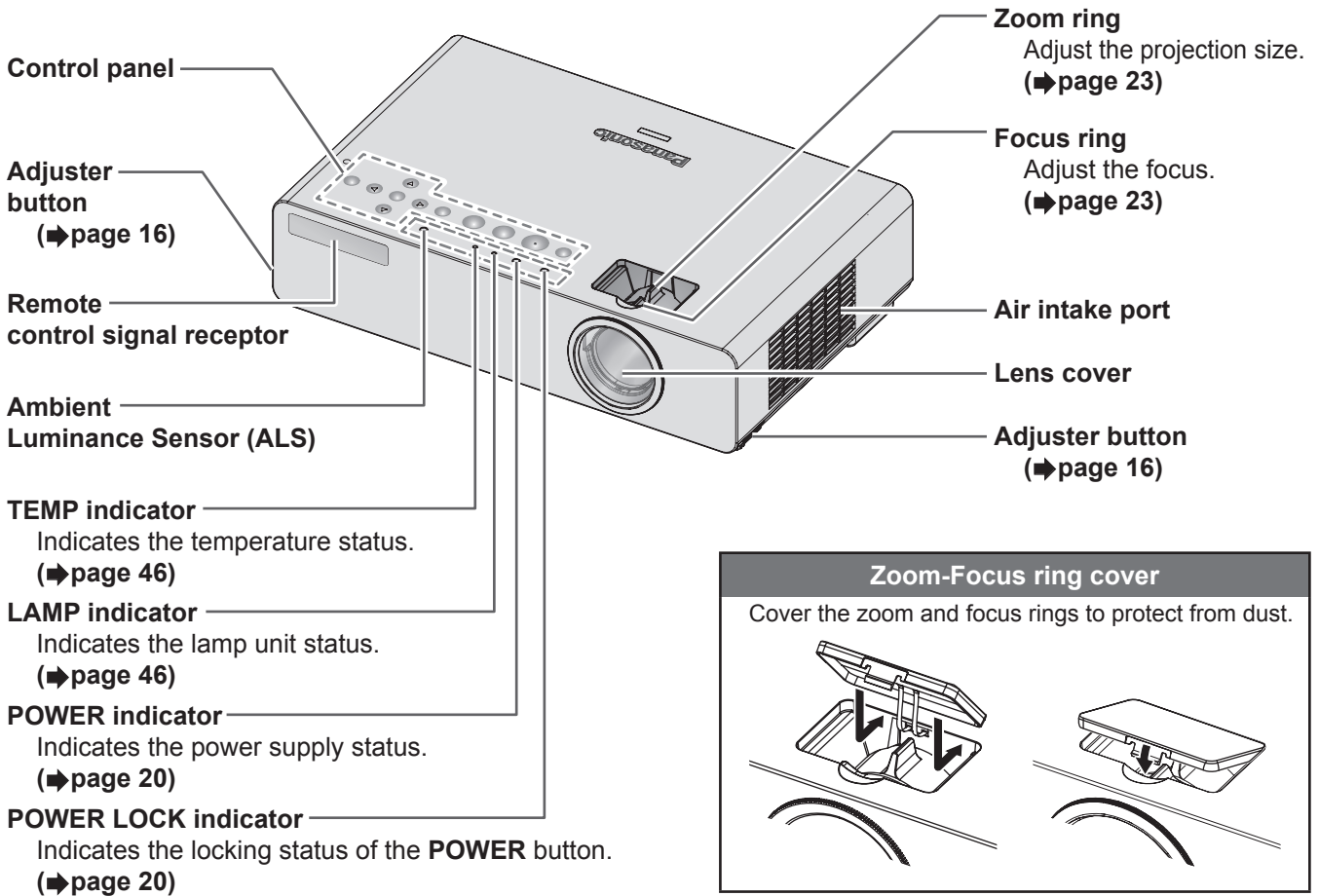

Note

- Do not use other than a provided power cord.
- Do not cover the ventilation openings of the air intake port or air outlet port.
- After adjusting the zoom and focus, be sure to close the Zoom-Focus ring cover to protect from dust.
- Do not apply extreme force on the Zoom-Focus ring cover.

Control panel

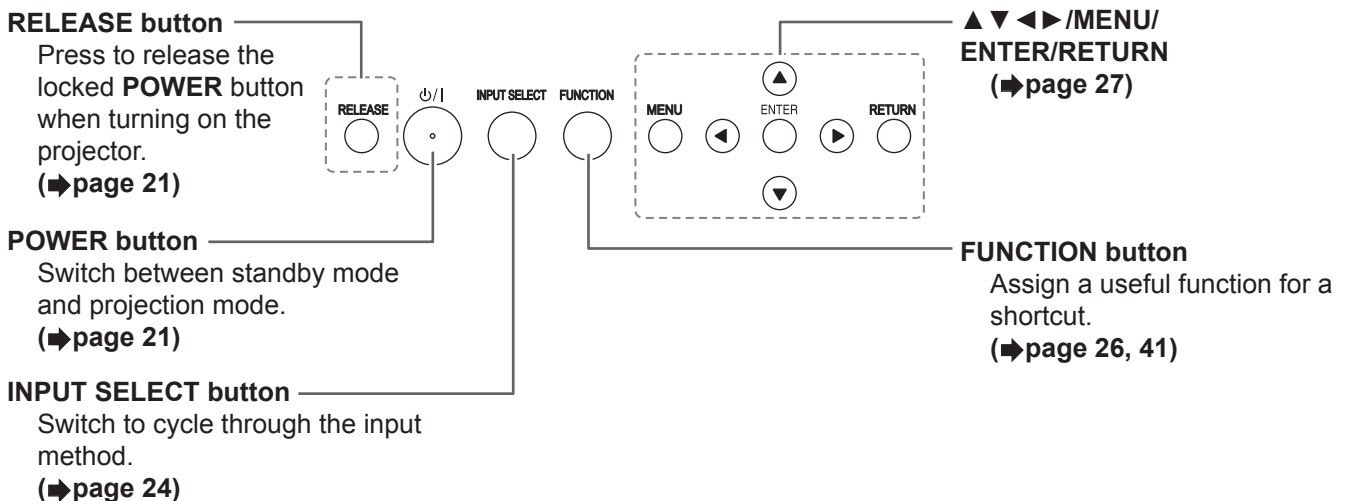

Back and bottom view

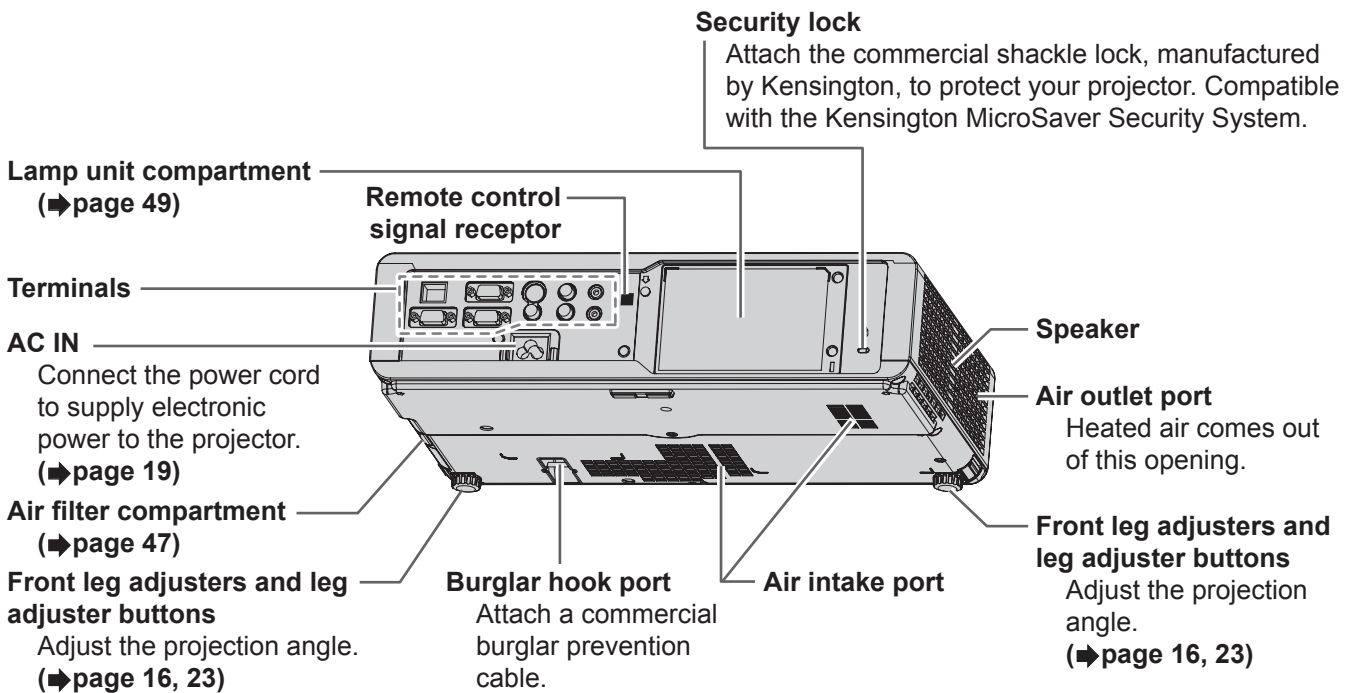

Terminals

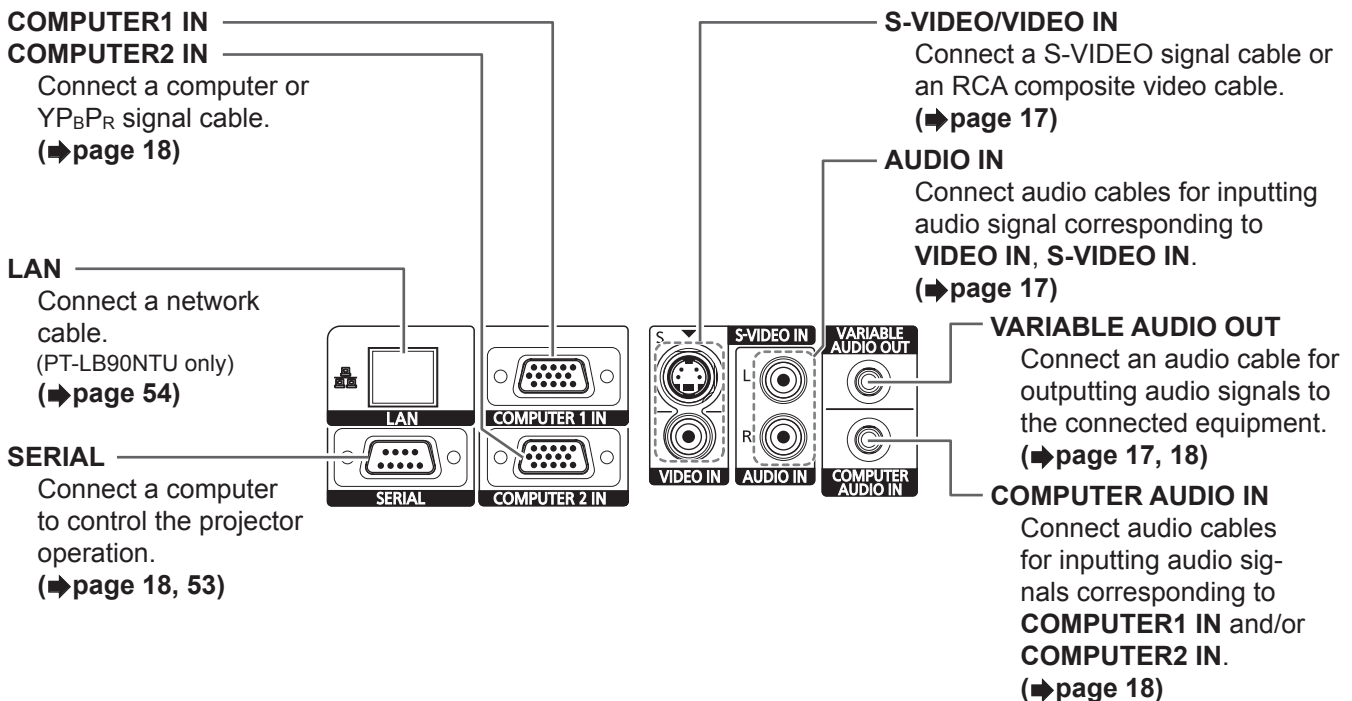

Note

- Do not place your hands or other objects close to the air outlet port as this may cause damage or injury.
- Heated air comes out of the air outlet port. Do not place your hands or face, or objects which cannot withstand heat close to this port.

About Your Projector

Remote control

Top view

Remote control signal emitters

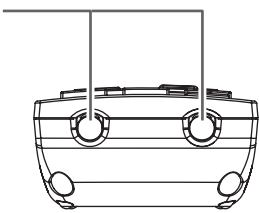

Battery compartment

Press the tab and lift up the cover.

Insert the batteries according to the polarity diagram indicated inside.

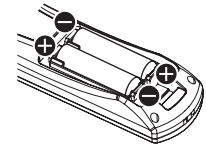
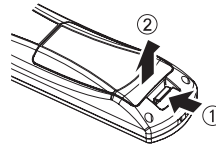

Front view

POWER button

Switch between stand-by mode and projection mode.

(▶page 21, 22)

Switch the required input signal button to select.

(The **NETWORK** button is only for PT-LB90NTU)
(See CD-ROM contents.)

(▶page 24)

Display the main menu.

(▶page 28)

Navigate through the menus with the ▲▼◀▶ buttons, and activate the menu item with **ENTER** button.

(▶page 27)

Capture the projected image as a frozen picture.

(▶page 24)

Reset some of the settings to the factory default settings.

(▶page 25)

The **MULTI-LIVE** button is only for PT-LB90NTU.

(See CD-ROM contents.)

Control to change the scale by means of digital zoom.

(▶page 26)

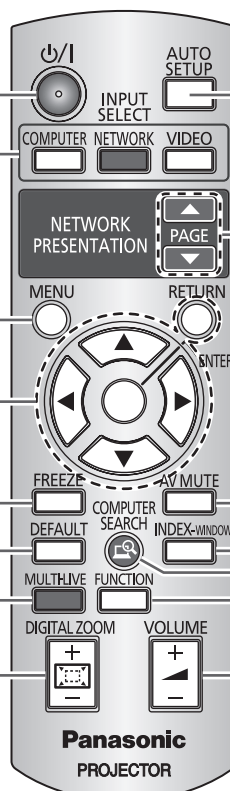

Detect the input signal and the setting of **SHIFT**, **DOT CLOCK** and **CLOCK PHASE** in **POSITION** menu will be adjusted automatically for **COMPUTER** signals.

(▶page 25)

The **PAGE** buttons are only for PT-LB90NTU.

(See CD-ROM contents.)

Turn off the projection temporarily.

(▶page 24)

Display the frozen image while the display of subsequent images continues.

(▶page 25)

The **COMPUTER SEARCH** button is only for PT-LB90NTU.
(See CD-ROM contents.)

Assign a useful function for a shortcut.

(▶page 26, 41)

Control to adjust the volume of the speaker.

(▶page 25)

Note

- Do not drop the remote control.
- Avoid contact with liquids or moisture.
- Do not attempt to modify or disassemble the remote control.
- Do not mix old and new batteries or batteries of different types.
Use only manganese batteries or alkaline batteries with the remote control.
- Do not swing the strapped remote control.

Remarks

- Do not let strong light shine onto the signal receptor.
The remote control may malfunction under strong light such as fluorescent.
- You can operate the projector with the remote control within the remote range of 15 m (49'2"), approximately $\pm 30^\circ$ vertically and horizontally.
- If there are any obstacles between the remote control emitter and the remote control signal receptor, the remote control may not operate correctly.
The operating range may differ due to the screen material, and this function may not be effective with a translucent screen.



Attaching a hand strap

You can attach a favourite strap onto the remote control.

Setting up

Screen size and throw distance

You can adjust the projection size with 1.2× zoom lens. Calculate and define the throw distance as follows.

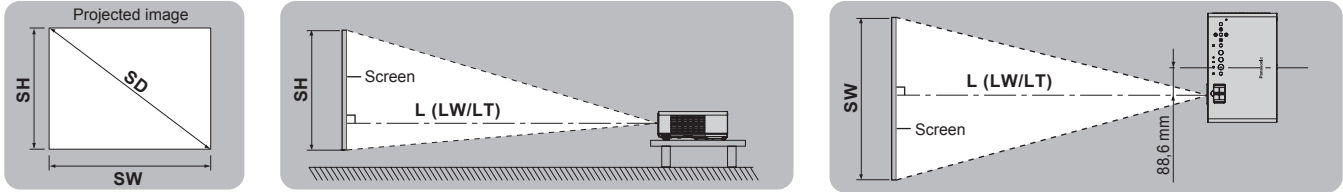

(All measurements below are approximate and may differ slightly from the actual measurements.)

Projection size	For 4:3 aspect ratio		For 16:9 aspect ratio	
	Minimum distance (LW)	Maximum distance (LT)	Minimum distance (LW)	Maximum distance (LT)
0.84 m (33")	—	1.1 m (3' 7")	—	1.2 m (3' 11")
1.02 m (40")	1.1 m (3' 7")	1.4 m (4' 7")	1.3 m (4' 3")	1.5 m (4' 11")
1.27 m (50")	1.4 m (4' 7")	1.7 m (5' 6")	1.6 m (5' 3")	1.9 m (6' 2")
1.52 m (60")	1.7 m (5' 6")	2.1 m (6' 10")	1.9 m (6' 2")	2.3 m (7' 6")
1.78 m (70")	2.0 m (6' 6")	2.4 m (7' 10")	2.2 m (7' 2")	2.6 m (8' 6")
2.03 m (80")	2.3 m (7' 6")	2.8 m (9' 2")	2.5 m (8' 2")	3.0 m (9' 10")
2.29 m (90")	2.6 m (8' 6")	3.1 m (10' 2")	2.8 m (9' 2")	3.4 m (11' 1")
2.54 m (100")	2.9 m (9' 6")	3.5 m (11' 5")	3.2 m (10' 6")	3.8 m (12' 5")
3.05 m (120")	3.5 m (11' 5")	4.2 m (13' 9")	3.8 m (12' 5")	4.6 m (15' 1")
3.81 m (150")	4.3 m (14' 1")	5.2 m (17' 0")	4.7 m (15' 5")	5.7 m (18' 8")
5.08 m (200")	5.8 m (19' 0")	7.0 m (22' 11")	6.3 m (20' 8")	7.6 m (24' 11")
6.35 m (250")	7.3 m (23' 11")	8.7 m (28' 6")	7.9 m (25' 11")	9.5 m (31' 2")
7.62 m (300")	8.7 m (28' 6")	10.5 m (34' 5")	9.5 m (31' 2")	11.4 m (37' 4")

You can calculate more detailed screen dimensions from the screen diagonal.

The results below are approximate and may differ slightly from the actual measurements.

If the projection size is SD,

	For 4:3 aspect ratio	For 16:9 aspect ratio
Screen height (SH)	= SD (m) × 0.0152	= SD (m) × 0.0125
Screen width (SW)	= SD (m) × 0.0203	= SD (m) × 0.0221
Minimum distance (LW)	= 0.0292 × SD (m) – 0.036	= 0.0318 × SD (m) – 0.022
Maximum distance (LT)	= 0.0351 × SD (m) – 0.044	= 0.0383 × SD (m) – 0.046

Note

- For the best quality of the projection image, install a screen where sunlight or room light does not shine directly onto the screen. Close window shades or curtains to block the light and turn off the lamps.
- Do not use the projector at a raised or a horizontally tilted position. Doing so may cause malfunction of the projector.
You can tilt the projector body approximately $\pm 30^\circ$ vertically and $\pm 10^\circ$ horizontally.
Overtilting may result in shortening the component's life.
- Do not cover the air outlet port and air intake ports or place anything within 50 cm (20") of them as this may cause damage or injury.

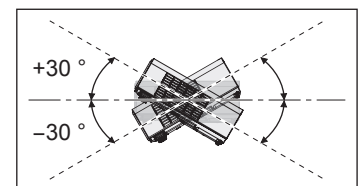

Setting up

Projection method

You can use the projector with any of the following 4 projection methods. To set the desired method in the projector, see "INSTALLATION" on page 39.

■ Setting on a desk/floor and projecting from front

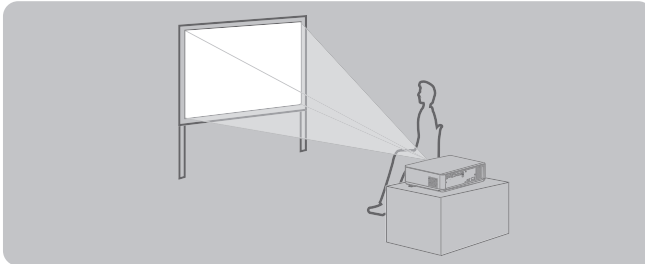

Menu	Method
INSTALLATION	FRONT/DESK

■ Mounting in the ceiling and projecting from front

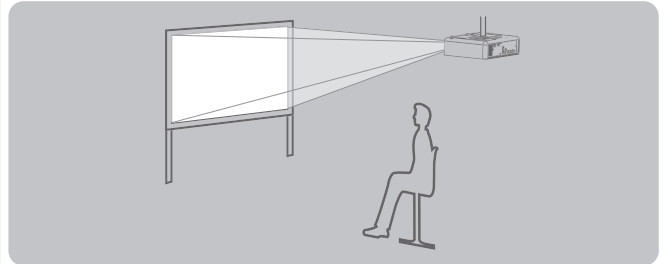

Menu	Method
INSTALLATION	FRONT/CEILING

■ Setting on a desk/floor and projecting from rear (Using translucent screen)

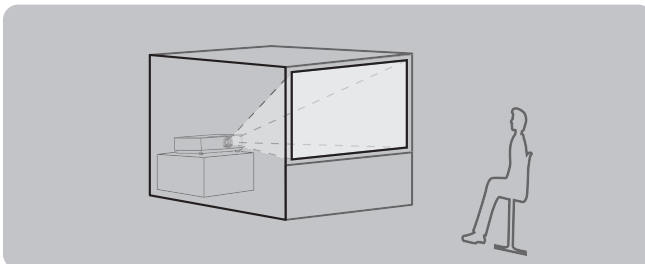

Menu	Method
INSTALLATION	REAR/DESK

■ Mounting in the ceiling and projecting from rear (Using translucent screen)

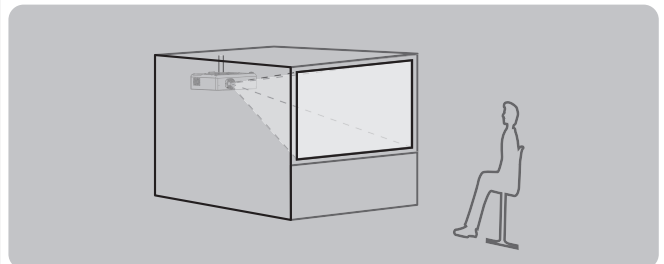

Menu	Method
INSTALLATION	REAR/CEILING

Remarks

- When mounting the projector in the ceiling, the optional ceiling mount bracket (ET-PKB80) is required.

Front leg adjusters and throwing angle

You can adjust the projection angle in the vertical direction by pressing the leg adjuster buttons. (▶page 23)

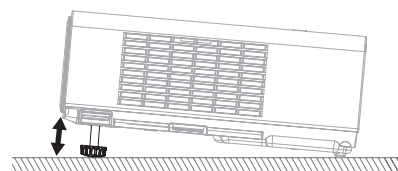
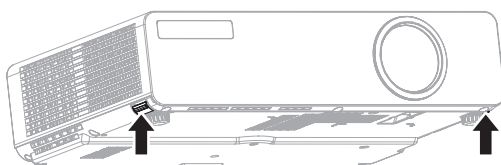

Note

- Heated air comes out of the air exhaust port. Do not touch the air exhaust port directly.
- If keystone distortion occurs, see "KEystone" on page 32.

Connections

Before connecting to the projector

- Read and follow the operating instructions of each peripheral device.
- The peripheral devices must be turned off.
- One RGB cable is provided with the projector. If necessary, prepare commercial connecting cables that match with the projector and each peripheral device terminal.
- If the input signal is affected by signal jitter, the projected image may have poor image quality and timebase correction is effective.
- Confirm the type of video signals, see “List of compatible signals”. (▶page 52)

Connecting example: AV equipment

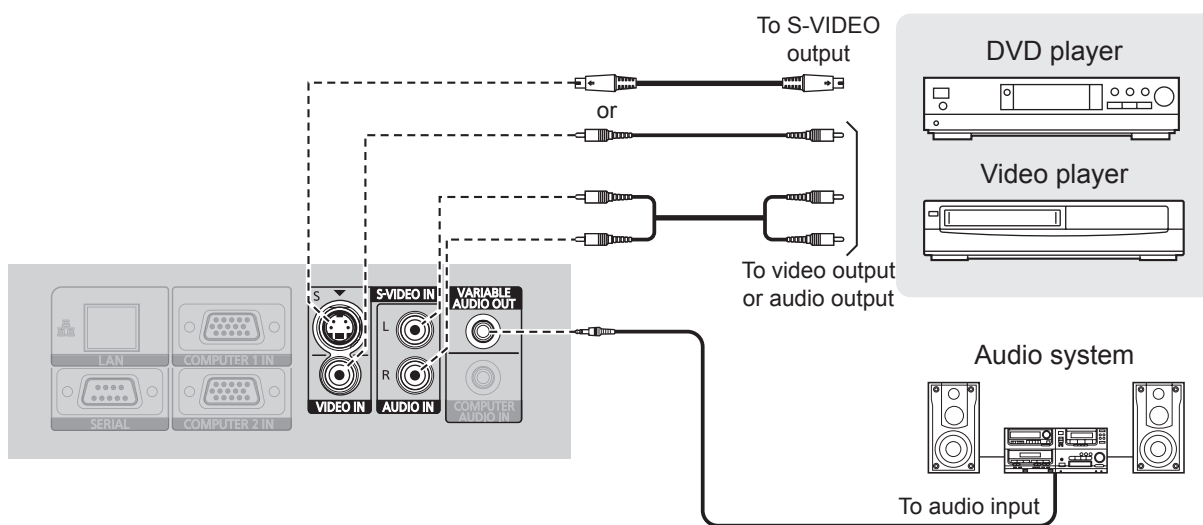

Remarks

- When you connect more than one AV equipment, switch the audio connection manually.
- Various connecting cables are not provided with the projector. If necessary, prepare commercial connecting cables that match with the projector and each peripheral device terminal.

Connections

Connecting example: Computers

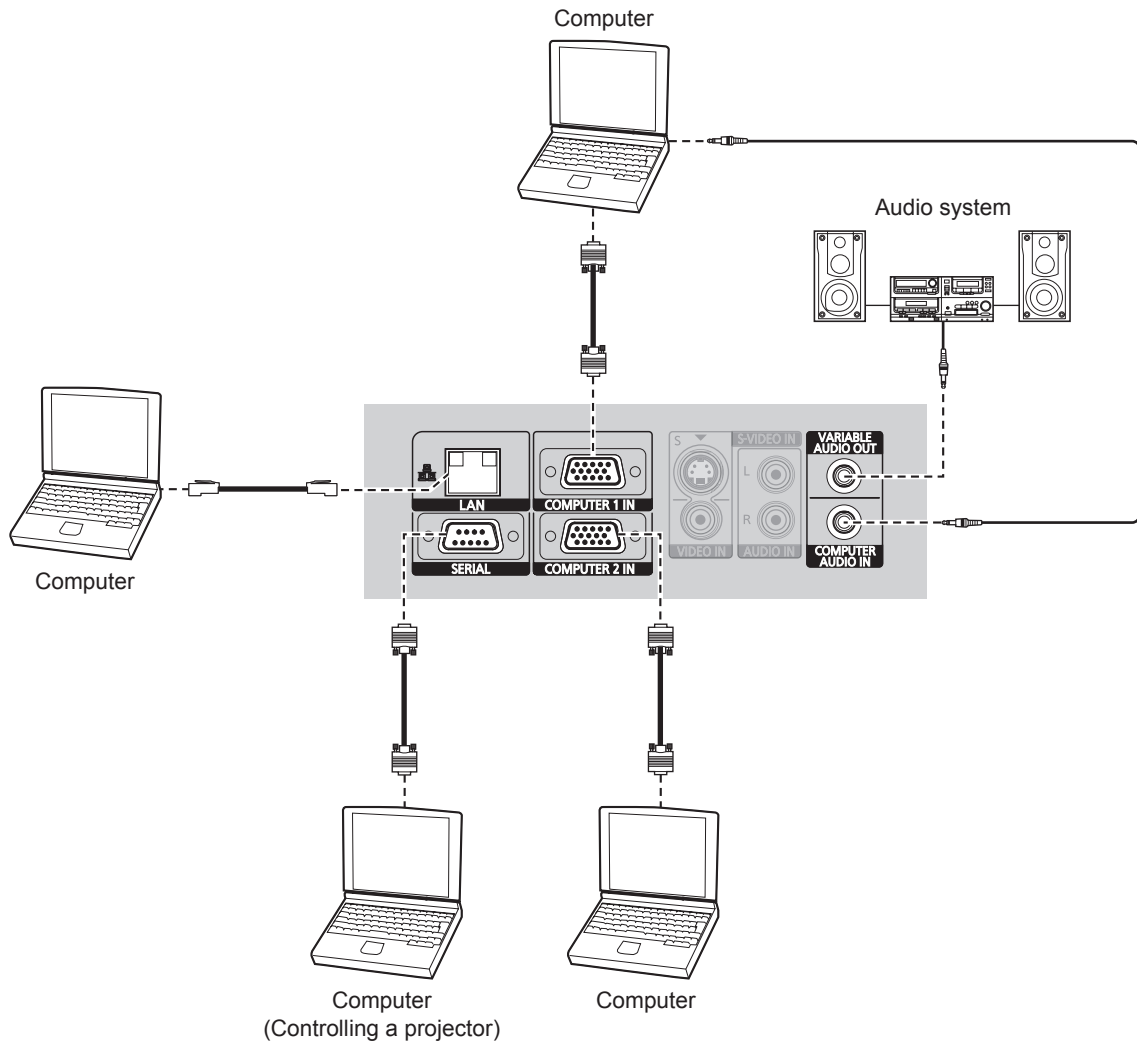

Note

- When connecting the RGB signal cable, be sure to securely tighten the fixing screws on the D-Sub (15-pin) wall outlet.

Remarks

- For the network connection between the projector and computers, see the CD-ROM contents provided . (PT-LB90NTU only)
- When you connect more than one computer, switch the computer connection manually.
- One RGB cable is provided with the projector. If necessary, prepare commercial connecting cables that match with the projector and each peripheral device terminals.

Switching the projector on/off

Power cord

Be sure to fix the power cord to the projector with the provided "Power cord secure lock" to prevent the power cord from coming off.

Connect the provided power cord securely.

For details, see "Precautions with regard to safety". (►pages 6 - 10)

■ Connecting

- 1) Make sure the shape of the power plug and the AC IN terminal on the back of the projector match, then push the plug all the way in.

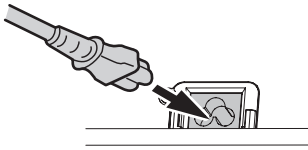

- 3) Place the latch to the latch catcher and press until it clicks.

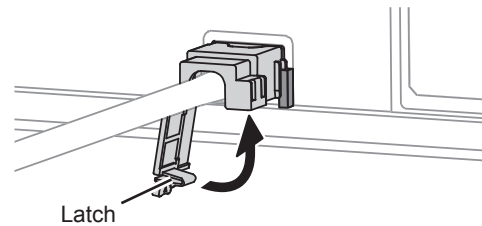

- 2) Align the side of the power cord secure lock with the side guide rail of the AC IN terminal of the projector and slide it in.

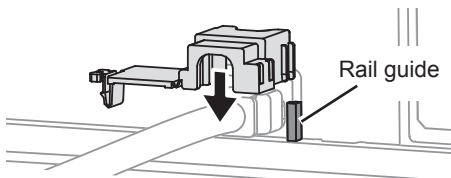

- 4) Connect the power cord to a wall outlet.

■ Disconnecting

- 1) Unplug the power cord from the wall outlet.
- 2) Depress the latch and slide the cover off.

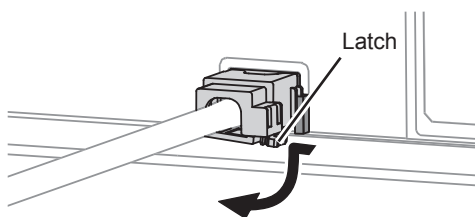

- 3) Slide the power cord secure lock up along the side guide rail and remove.

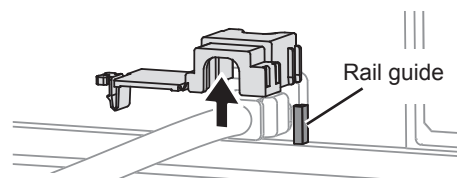

- 4) Hold the plug and unplug the power cord from the AC IN terminal on the back of the projector.

■ Direct power off function

You can switch off the electric power supply any time by unplugging the power plug from the wall outlet or by switching off the main power. The internal lamp cooling fan keeps operating by the internal power supply, and stops automatically when cooled enough.

Note

- Do not put the projector into the carrying bag with the **POWER** indicator lit.

■ Direct power on function

If **INITIAL START UP** in the **PROJECTOR SETUP** menu is set to **ON**, connect the power cord to a wall outlet and the projection will start even when the control panel is disabled or the **POWER** button is locked. (►page 39)

Switching the projector on/off

POWER and POWER LOCK indicators

The **POWER** indicator informs you of the status of the power and the **POWER LOCK** indicator shows the status of the **RELEASE** button. When the **TEMP** indicators are flashing, the **POWER** and **POWER LOCK** indicators will light red and you cannot switch the projector on.

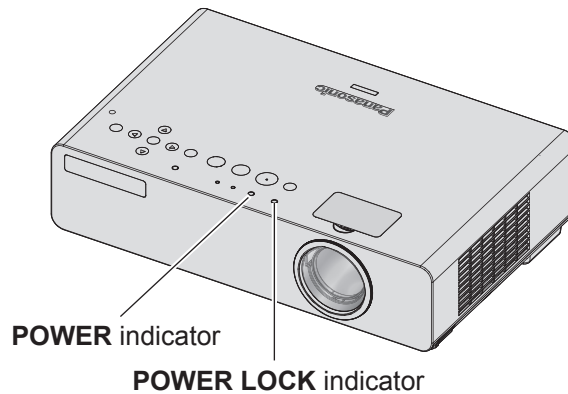

POWER LOCK indicator status

Indicator status		Status
No illumination or flashing		<ul style="list-style-type: none"> No power is supplied. The RELEASE button is pressed and the POWER button is unlocked while the power is on.
Red	Lit	The POWER button is locked.
	Flashing	Pressing the locked POWER button.

POWER indicator status

Indicator status		Status
No illumination or flashing		No power is supplied and the internal cooling fan is not operating.
Red	Lit	The power is turned off (when STANDBY MODE is set to ECO). If the POWER button is pressed, projection starts.
	Flashing	The power is turned off (when STANDBY MODE is set to NORMAL).
Green	Flashing	The power is on and preparing for projection.
	Lit	The projector is projecting.
Orange	Lit	No power supply and the internal fan is cooling the lamp by internal power supply.
	Flashing	The power is switched on again while cooling the lamp and recovering to the projection mode. Recovery may take a while.

Remarks

- When the power is turned off, the internal fan is cooling the lamp by internal power supply.
- The power is switched on again while cooling the lamp and recovering to the projection mode. Recovery may take a while.
- Even while the power is turned off (when **STANDBY MODE** is set to **ECO**, the **POWER** indicator is lit in red), power of about 0.9 W is consumed.

Switching on the projector

Before switching on the projector, make sure the power cord and all the other devices are connected correctly. (➔page 17)

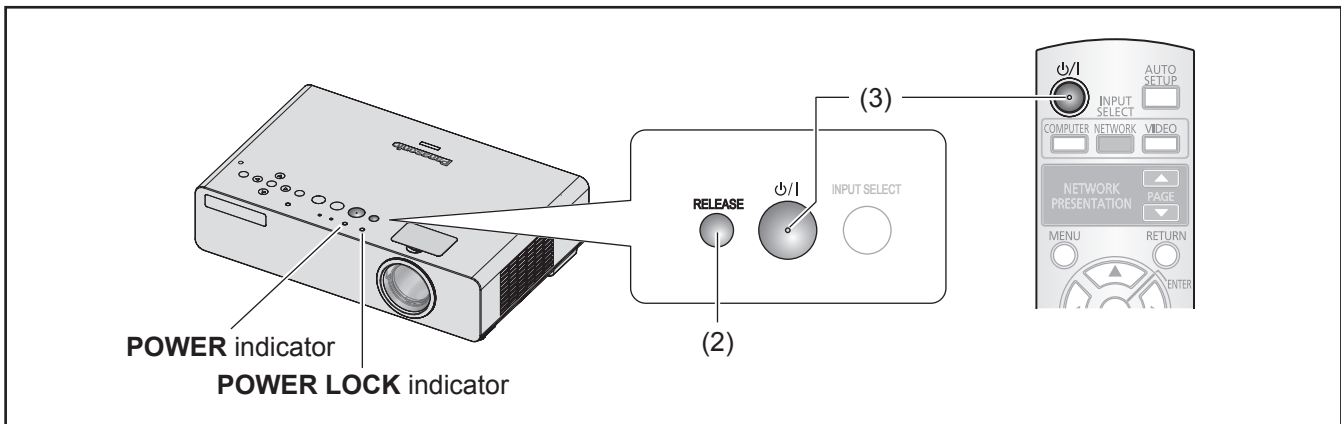

1) Connect the power cord. (➔page 19)

The **POWER LOCK** indicator and **POWER** indicator light in red.

2) Press the **RELEASE** button to unlock the **POWER** button.

The **POWER LOCK** indicator goes off.

- When operating with the remote control, you do not need to press the **RELEASE** button.

3) Press the **POWER** button.

The **POWER** button beeps once.

- You can turn **ON** or **OFF** the beeping sound that occurs when you press the **POWER** button by menu setting. (➔page 41)
- The **POWER** indicator flashes in green several times, then the **POWER** indicator lights up and the **STARTUP LOGO** is displayed. See "STARTUP LOGO" in the "DISPLAY OPTION" menu. (➔page 37)

Note

- Operating the control panel buttons with covered hand, such as plastered or gloved, may result in operating errors.

Remarks

- Confirm that **CONTROL PANEL** (when operating with the projector body) or **REMOTE CONTROLLER** (when operating with the remote control) under **CONTROL DEVICE SETUP** in the **SECURITY** menu is set to **ENABLE**. (➔page 44)
- The projector does not operate when the **POWER** button of the projector body is pressed while it is locked.
- If the **POWER** button is not being pressed in 10 seconds after the **RELEASE** button is pressed, the **POWER LOCK** indicator lights in red and the **POWER** button remains locked. Press the **RELEASE** button again to unlock.
- When starting up the projector, some small rattling or tinkling sound may be heard. Those are normal and will not affect the performance of the projector.
- When the internal cooling fan is operating, some operational sound may be heard. The loudness of the operational sound depends on the external temperature.
- If **INITIAL START UP** in the **PROJECTOR SETUP** menu is set to **ON**, the projector starts projecting when the power cord is connected to a wall outlet. (➔page 39)
- If the projector is switched on again while the internal cooling fan is still operating by the internal power supply, the display may flicker for the characteristics of the lamp. Those are normal and will not affect the performance of the projector.

Switching the projector on/off

Switching off the projector

When operating the projector, check the status of the **POWER** indicator. (➡page 20)

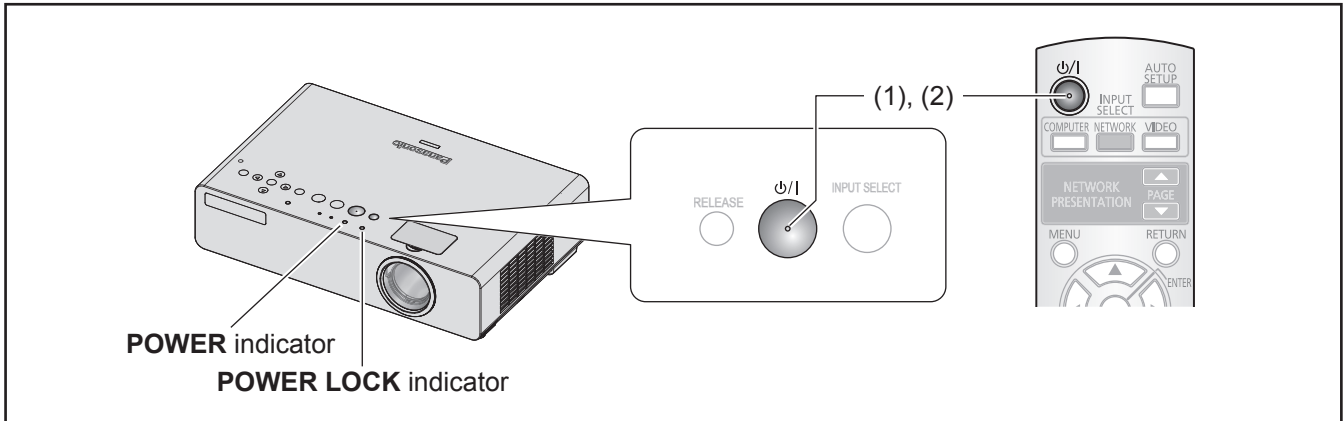

1) Press the **POWER** button.

The confirmation screen will be displayed.

- Without any operation for 10 seconds or press any button other than the **POWER** button, the confirmation screen will go off and return to the projection.

2) Press the **POWER** button again.

The lamp goes off, the operational sound (beep) sounds, and projection stops.

- The cooling fan continues its rotation and **POWER** indicator lights in orange. Wait until the **POWER LOCK** indicator and **POWER** indicator turn into red.
- If **STANDBY MODE** is set to **NORMAL**, the **POWER** indicator flashes in red. (➡page 40)
- You can set to **ON** or **OFF** the beeping sound that occurs when the **POWER** button is in operation in **AUDIO SETTING**. (➡page 41)

3) After the **POWER LOCK** indicator and **POWER** indicator light in red, disconnect the power plug from the wall outlet. (➡page 19)

- For urgency, you may disconnect the power plug immediately since the **DIRECT POWER OFF** function is installed.

Remarks

- Confirm that **CONTROL PANEL** (when operating with the projector body) or **REMOTE CONTROLLER** (when operating with the remote control) under **CONTROL DEVICE SETUP** in the **SECURITY** menu is set to **ENABLE**. (➡page 44)
- You can switch off the power by pressing the **POWER** button for 0.5 seconds or more.

Projecting an image

Confirm the connections of the peripheral devices (➔page 17, 18) and power cord (➔page 19). Switch on the power (➔page 21) and the projector starts projecting. Select the input signal and adjust the image.

Selecting the input signal

1) Switch on the connected devices.

When playing a connected DVD player, if **SIGNAL SEARCH** in the **DISPLAY OPTION** menu is set to **ON**, the input signal is detected and projected automatically when the projector is switched on. (➔page 37)

- Set the **INPUT GUIDE** under the **ON-SCREEN DISPLAY** in the **DISPLAY OPTION** menu to **DETAILED**. If the projector cannot detect any input signal, the Computer connection guidance will display. (➔page 36)

2) Select an input signal.

The image selected with the **INPUT SELECT** button is projected. (➔page 24)

Note

- Change the setting of the **PICTURE** menu according to the connected device and DVD, video tape, etc., to be played. (➔page 31)
- Confirm the aspect ratio of the screen and image. Select the optimum aspect ratio. (➔page 33)

Positioning the image

When setting up the projector for the first time or setting up at a new place, you must perform the following operations.

1) Adjust the vertical angle of the projector.

- Place the projector at the right angle from the screen.

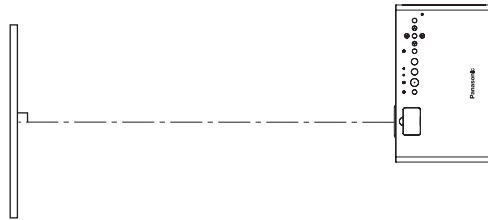

- Press the adjuster buttons and adjust the vertical projection angle. Then, adjust the projected image to the center of the screen.

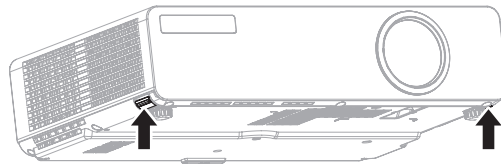

2) Adjust the projection size and focus.

- Remove the Zoom-Focus ring cover (➔page 12) and turn the zoom and focus rings to adjust the projected image. After adjusting, be sure to install the Zoom-Focus ring cover to protect from dust.

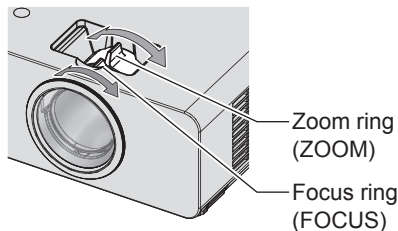

Remarks

- When you adjust the zoom after adjusting the focus, you may need to adjust the focus of the image again.
- If keystone distortion occurs, see "KEYSTONE". (➔page 32)

Remote control operation

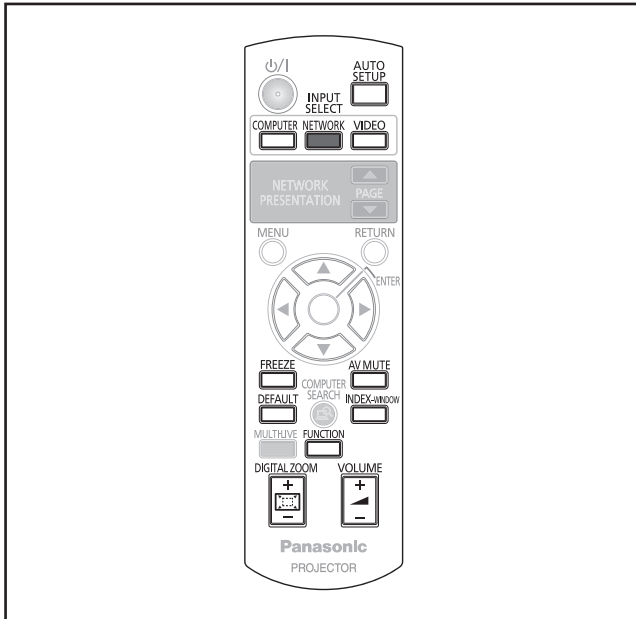

Capturing an image

You can freeze the projected image and stop the sound temporarily, regardless of the playing condition of the connected device.

Press **FREEZE** button.

Press the **FREEZE** button again to escape.

Stopping the projection temporarily

You can stop the projection and audio sound through the projector temporarily.

Press **AV MUTE** button.

Press the **AV MUTE** button again to escape.

Switching the input signal

You can switch the input signal corresponding to the computer to be projected.

COMPUTER

Press **COMPUTER** button.

Press the **COMPUTER** button to cycle through the options.

COMPUTER1	Signal input to COMPUTER1 IN terminal
COMPUTER2	Signal input to COMPUTER2 IN terminal

NETWORK (PT-LB90NTU only)

Press **NETWORK** button.

NETWORK	Signal transmitted by “Wireless Manager” from computer through network (▶page 45)
----------------	---

VIDEO

Press **VIDEO** button.

Press the **VIDEO** button to cycle through the options.

S-VIDEO	Signal input to S-VIDEO IN terminal
VIDEO	Signal input to VIDEO IN terminal

If **INPUT GUIDE** under the **ON-SCREEN DISPLAY** in the **DISPLAY OPTION** menu is set to **DETAILED** (▶page 36), you can confirm the selected input terminal in the graphical input terminal guide at the upper right of the screen. (Highlighted in yellow is the selected terminal.)

You can change the input with **▲▼◀▶** buttons. It may take some time to change the image after the input signal is switched.

Note

- Input a compatible signal shown in the “List of compatible signals”. (▶page 52)

Remarks

- For the input terminals, see “Connections”. (▶page 17)
- If no operation is performed, the input guide disappears automatically.
- If the **INPUT SELECT** button on the control panel is pressed, the input is switched in the following order. (▶page 12)

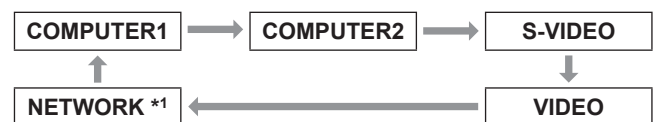

*1: PT-LB90NTU only

Setting up the image position automatically

When a RGB signal is input, the projector adjusts the **SHIFT**, **DOT CLOCK** and **CLOCK PHASE** automatically.

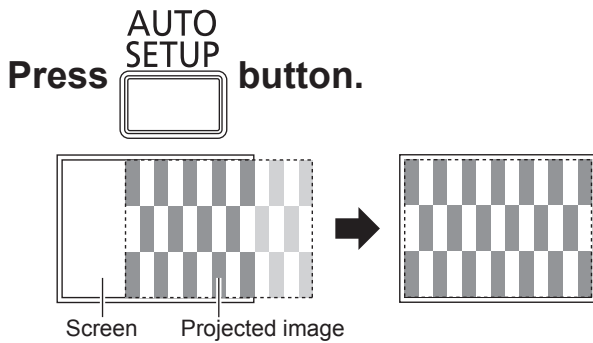

Remarks

- The **SIGNAL SEARCH** operation is also performed. (When **SIGNAL SEARCH** is set to **ON**) (➔page 37)
- If the dot clock frequency is 108 MHz or higher, **DOT CLOCK** and **CLOCK PHASE** are not effective. (➔page 32)
- If the projected image is too dark or blurred around the edge, **AUTO SETUP** may stop the processing before completing the adjustment and return to the previous setting. Project a much clearer or lighter image and try again.

Resetting to the factory default settings

You can reset most of the customised settings to the factory default settings by pressing the **DEFAULT** button of the remote control.

Press  button.

- For details, see “Menu Navigation - Navigating through the MENU - Resetting to the factory default settings”. (➔page 27)

Controlling the volume of the speaker

You can control the volume of the built-in speakers and output audio sound.

Press  button.

- **+** button: increases the volume
- **-** button: decreases the volume

Projecting an image in INDEX-WINDOW mode

You can project an image split in 2 windows as an **INDEX WINDOW**. One is frozen and stored in memory, and displayed on the screen's left side while displaying subsequent image continues on the right.

Press  button.

Press the **RETURN** button to escape. The image being projected when the **INDEX-WINDOW** button is pressed will be a frozen image.

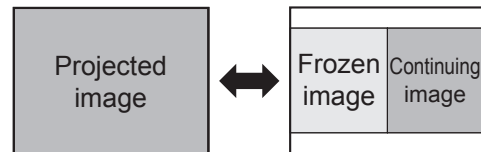

INDEX-WINDOW display

Press **▲▼** buttons to capture a new image and change the size in 3 ways.

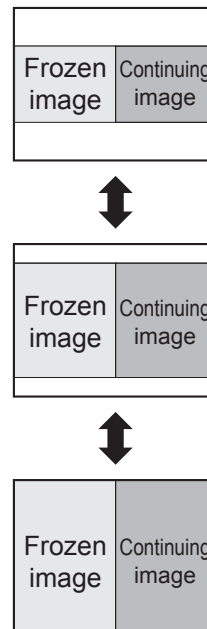

In default, the frozen image is displayed on the left and the subsequent image is displayed on the right. Press **◀▶** buttons to switch the position.

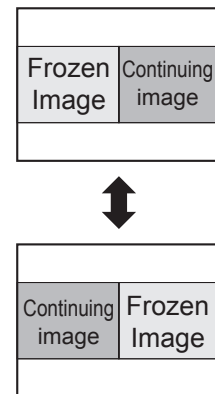

Remarks

- The aspect ratio of the image is changed and becomes vertically elongated.
- If you change the window size, the aspect ratio of the image is changed. (➔page 33)
- While in **INDEX-WINDOW** mode, press the **ENTER** button to capture a new image and the frozen image window will be updated in a moment.
- When capturing a quick moving picture, perform several times to get a stable picture.

Remote control operation

Enlarging the image

You can enlarge the projected image down to a centered area for emphasizing within the range of 1× to 2×.

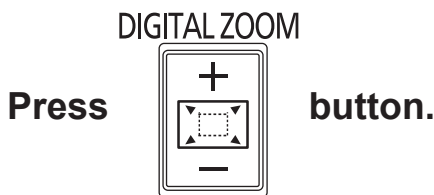

Press the **RETURN** button to escape.

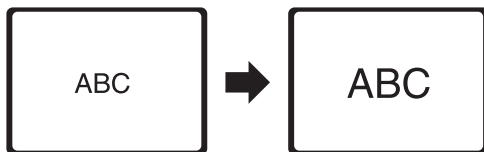

Button functions in digital zoom mode

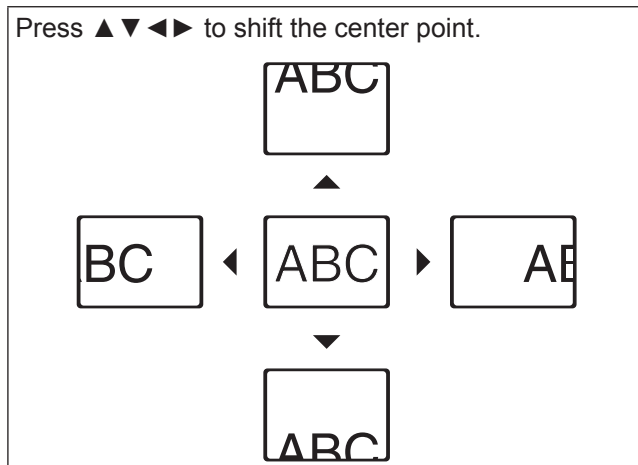
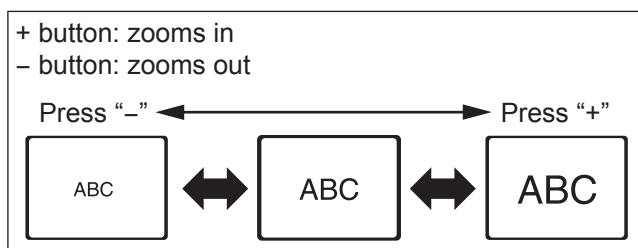

Remarks

- When the **COMPUTER** signal is projected, the enlargement range will be changed to 1× to 3×. When **FRAME LOCK** in the **POSITION** menu is set to **ON**, the enlargement range is 1× to 2×. However, the enlargement range is 1× to 3× if **FRAME LOCK** is set to **OFF**. (▶page 34)
- When the input signal is changed while the **DIGITAL ZOOM** is activated, the **DIGITAL ZOOM** mode will be cancelled.
- While the **DIGITAL ZOOM** is activated, the **AUTO SETUP**, **FREEZE**, **DEFAULT**, **INDEX-WINDOW** and **FUNCTION** (except when **AV MUTE** is assigned) buttons are not available.

Using an assigned function

You can select a useful function from the list and assign it to the **FUNCTION** button for a short-cut.

Press  button.

- 1) Press the **MENU** button of the control panel or remote control to display the on screen menu (main menu, sub-menu or detailed menu) .
For the menu operation, see “Navigating through the MENU”. (▶page 27)
- 2) Press and hold the **FUNCTION** button of the control panel or remote control for 3 seconds or more.

●When not using the FUNCTION button

- 1) Select **DISABLE** in this menu (**FUNCTION BUTTON** in the **PROJECTOR SETUP** menu).
- 2) Press the **ENTER** button.
- 3) Select **OK**.
- 4) Press the **ENTER** button.

Remarks

- For details, see “FUNCTION BUTTON” in the “PROJECTOR SETUP menu”. (▶page 41)

Menu Navigation

Navigating through the MENU

Operating procedure

1) Press the MENU button.

The main menu is displayed.

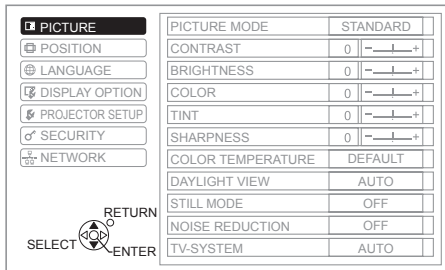

2) Press ▲▼ to scroll to the required main menu item and press the ENTER button to select.

Select the required menu item from the **PICTURE, POSITION, LANGUAGE, DISPLAY OPTION, PROJECTOR SETUP, SECURITY** and **NETWORK** *1 menu. The selected item is highlighted in orange and displays the sub-menu on the right.

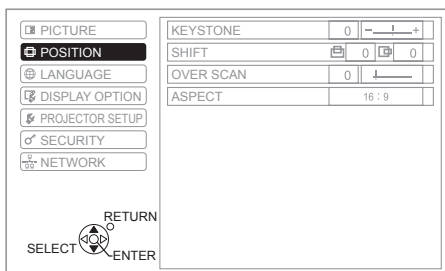

3) Press the ENTER button.

You can select a sub-menu item.

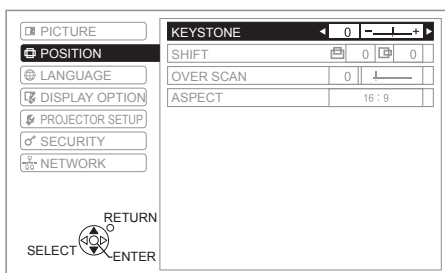

4) Press ▲▼ buttons to scroll to the required sub-menu item and press ◀▶ buttons or the ENTER button to adjust.

The selected item is called up and the other menu items disappear from the screen.

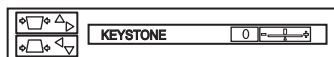

If there is a lower level, the next level will be displayed.

*1: PT-LB90NTU only

Remarks

- Press the **MENU** or **RETURN** button to return to the previous menu. Press repeatedly to escape from the menu mode and return to the projection.
- Some items and functions may not be adjusted or available, depending on the selected input signals.
- Some settings are adjustable without any signals.
- Called up item will disappear after 5 seconds without any operation and return to the menu mode.
- For the sub-menu items, see “Sub-menu” in the “ON-SCREEN MENU”. (▶page 28)

Resetting to the factory default settings.

You can reset most of the customised settings to the factory defaults by pressing the **DEFAULT** button of the remote control.

Press  button.

The operation depends on the screen displayed currently.

- While the sub-menu screen is displayed:
The items of the sub-menu displayed currently are reset to the factory default settings.
- While the called up item screen is displayed:
Only the item adjusted currently is reset to the factory default setting.

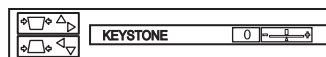

Remarks

- You cannot reset all the settings at a time to the factory default settings.
To reset all the settings to the factory defaults, see “INITIALIZE ALL” in the “PROJECTOR SETUP menu”. (▶page 42)
- Some menu items are not available to reset by pressing the **DEFAULT** button. Adjust each menu item manually.
- The triangle mark under the bar indicates factory default setting and the square indicates the current setting.
The triangle mark position varies by the selected input signals.

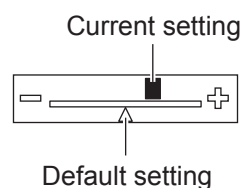

Menu Navigation

The menu system allows you to access functions which do not have their own dedicated buttons on the remote control. The menu options are structured and categorized. For the menu operation, see “Navigating through the MENU”. (▶page 27)

ON-SCREEN MENU

MENU
Press  button.

The **ON-SCREEN MENU** is displayed.
The **ON-SCREEN MENU** consists of the main menu and sub-menu.

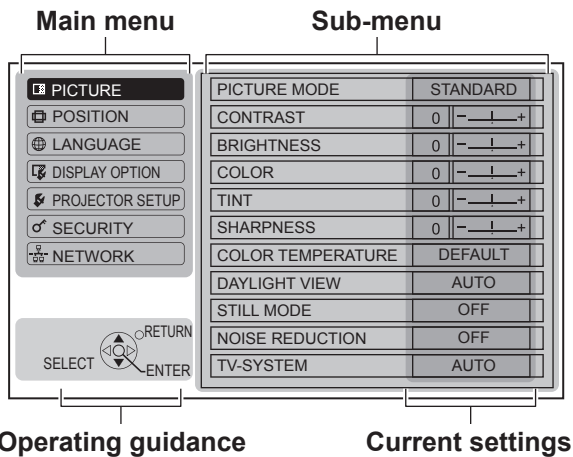







Operating guidance

Current settings

The operating method of each menu is displayed.

Main menu

The main menu has the 7 options.
Select the required menu item and press **ENTER** to display the sub-menu.

	PICTURE
	POSITION
	LANGUAGE
	DISPLAY OPTION
	PROJECTOR SETUP
	SECURITY
	NETWORK (PT-LB90NTU only)

Sub-menu

Select the required sub-menu item and press **ENTER** to display the detailed menu.

PICTURE []

- **S-VIDEO/VIDEO/RGB** (Moving image)/YP_BP_R signal is input *1

Sub-menu item	Default	Page
PICTURE MODE	STANDARD	30
CONTRAST	0	30
BRIGHTNESS	0	30
COLOR	0	30
TINT	0	30
SHARPNESS	0	30
COLOR TEMPERATURE	DEFAULT	30
DAYLIGHT VIEW	AUTO	31
STILL MODE *2	OFF	31
NOISE REDUCTION *2	OFF	31
TV-SYSTEM *2	AUTO	31
RGB/YP_BP_R *3	AUTO	31

*1: RGB moving images can be projected only when the following signals are input:

480i, 576i (RGB only), 480p, 576p, 1 080/60i, 1 080/50i, 720/60p, 720/50p

*2: Only when S-VIDEO/VIDEO signal is input.

*3: Only when RGB/YP_BP_R signal is input.

- When RGB (Still image)/network signal is input

Sub-menu item	Default	Page
PICTURE MODE	DYNAMIC	30
CONTRAST	0	30
BRIGHTNESS	0	30
SHARPNESS	0	30
WHITE BALANCE RED *1	0	30
WHITE BALANCE GREEN *1	0	30
WHITE BALANCE BLUE *1	0	30
COLOR TEMPERATURE	DEFAULT	30
DAYLIGHT VIEW	AUTO	31
RGB/YP_BP_R *2	AUTO	31

*1: Only when RGB signal is input.

*2: Only when RGB signal (VGA60) is input.

Remarks

- The factory default values vary depending on the **PICTURE MODE** setting.

■ POSITION []

Sub-menu item	Default	Page
REALTIME KEYSTONE	ON	32
KEYSTONE	0	32
SHIFT *1	0	32
DOT CLOCK *1	0	32
CLOCK PHASE *1	0	32
OVER SCAN *1	0	33
ASPECT *1	16:9	33
FRAME LOCK *1	OFF	34

*1: The setting is active or deactive, depending on the input signal and the specific setting.

■ LANGUAGE []

For details, see “LANGUAGE menu”. (▶page 35)

■ DISPLAY OPTION []

Sub-menu item	Default	Page
ON-SCREEN DISPLAY	—	36
STARTUP LOGO	ON	37
AUTO SETUP	AUTO	37
SIGNAL SEARCH	ON	37
BACK COLOR	BLUE	37
WIDE MODE *1	AUTO	38
SXGA MODE *1	SXGA	38
OTHER FUNCTIONS	—	38

*1: The setting is active or deactive, depending on the input signal and the specific setting.

■ PROJECTOR SETUP []

Sub-menu item	Default	Page
STATUS	—	39
NO SIGNAL SHUT-OFF	DISABLE	39
INITIAL START UP	LAST MEMORY	39
INSTALLATION	FRONT/DESK	39
HIGH ALTITUDE MODE	OFF	39
STANDBY MODE	ECO	40
LAMP POWER	NORMAL	40
LAMP RUNTIME	—	40
EMULATE	DEFAULT	40
FUNCTION BUTTON	STATUS	41
AUDIO SETTING	—	41
TEST PATTERN	—	42
INITIALIZE ALL	—	42

■ SECURITY []

Sub-menu item	Default	Page
PASSWORD	OFF	43
PASSWORD CHANGE	—	43
TEXT DISPLAY	OFF	43
TEXT CHANGE	—	43
MENU LOCK	OFF	44
MENU LOCK PASSWORD	—	44
CONTROL DEVICE SETUP	—	44

■ NETWORK [] (PT-LB90NTU only)

For details, see “NETWORK menu”. (▶page 45)

Sub-menu item	Default
WIRED LAN	—
WIRELESS LAN	S-MAP
NAME CHANGE	—
PASSWORD	OFF
PASSWORD CHANGE	—
NETWORK CONTROL	ON
LIVE MODE CUT IN	OFF
COMPUTER SEARCH	—
MULTI-LIVE	—
STATUS	—
INITIALIZE	—

Remarks

- Sub-menu items and the factory default settings vary according to the selected input signal.

PICTURE menu

Navigating through the MENU (▶page 27), select PICTURE from the main menu and then select the required item from the sub-menu.

- Set the selected item with ◀▶ buttons.

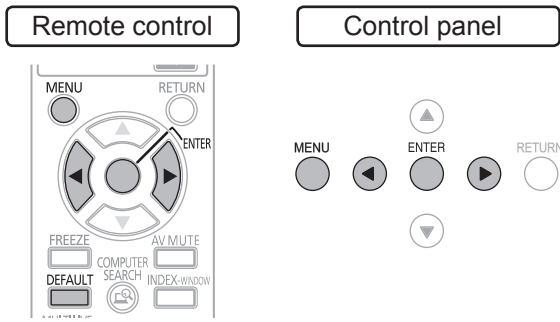

PICTURE MODE

Depending on the projection environment, you can optimize the image projection.

Change setting ◀▶ Change setting

Press ◀▶ buttons to cycle through the options.



STANDARD	Setting for general image
DYNAMIC	Setting for brightness and sharpness
BLACKBOARD	Setting for when projecting on a blackboard
WHITE BOARD	Setting for when projecting on a white board
NATURAL	Reproducing the original color of the image

Remarks

- It may take a while until the selected mode is stabilized.

CONTRAST

You can adjust the contrast of the projected image.

Lower ◀▶ Higher

BRIGHTNESS

You can adjust the brightness of the projected image.

Darker ◀▶ Brighter

COLOR

You can adjust the color saturation of the projected image. (Available with signals of S-VIDEO/VIDEO/RGB (Moving image)/YPbPr only)

Lighter ◀▶ Darker

TINT

You can adjust the skin tone in the projected image. (Available with signals of S-VIDEO/VIDEO/RGB (Moving image)/YPbPr only)

More reddish ◀▶ More greenish

SHARPNESS

You can adjust the sharpness of the projected image.

Less sharp ◀▶ More sharp

Remarks

- The adjustable range depends on the input signal.

WHITE BALANCE

You can adjust the white balance more properly in 3 colors temperature. (Available with signal of RGB (Still image) only)

-1 ◀▶ +1

Press ▲ ▼ buttons to cycle through the options.

Advanced menu item	Default
WHITE BALANCE RED	0
WHITE BALANCE GREEN	0
WHITE BALANCE BLUE	0

COLOR TEMPERATURE

You can adjust the white balance of the projected image.

Change setting ◀▶ Change setting



DEFAULT	Balanced white
HIGH	More bluish
LOW	More reddish

DAYLIGHT VIEW

You can keep the projected image bright and vivid even in well-lit rooms where the ambient light sources cannot be controlled, such as when a door opens or when window coverings fail to block out sunlight.

Change setting   Change setting

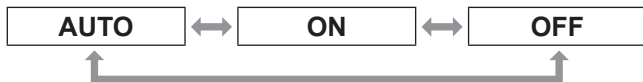

AUTO	Automatic adjustment
ON	Active
OFF	Deactive

Remarks

- Do not cover the Ambient Luminance Sensor (**ALS**) of the projector. The **AUTO** mode may not operate normally.
- **AUTO** is not available when **INSTALLATION** in **PROJECTOR SETUP** menu is set to **REAR/DESK** or **REAR/CEILING**.

STILL MODE

You can reduce the vertical flicker when projecting a still image.

(Available with signals of **S-VIDEO/VIDEO** only)

Change setting   Change setting

OFF	Deactive
ON	Active

Note

- You must set to **OFF** when projecting a moving image.

NOISE REDUCTION

You can switch the automatic noise reduction system on/off.

(Available with signals of **S-VIDEO/VIDEO** only)

Change setting   Change setting

OFF	No noise reduction
ON	Automatic noise reduction

Note

- **NOISE REDUCTION** is set active when the selected input signal has less noise. Applying noise reduction may affect the image quality, if so, set to **OFF**.

TV-SYSTEM

When the video signal is changed, the setting switches automatically. You can switch the setting manually to match the video data.

(Available with signals of **S-VIDEO/VIDEO** only)

Change setting   Change setting

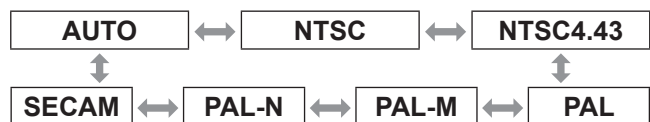

Note

- **AUTO** mode is selected by default.
- When the projector is not working properly in **AUTO** mode, change the setting according to each TV system type.

Remarks

- **AUTO** setting will automatically select the compatible signal from **NTSC/NTSC 4.43/PAL/PAL60/PAL-M/PAL-N/SECAM**.

RGB/YP_BPR

AUTO mode is selected by default. If the image is not projected normally in the **AUTO** mode, select **RGB** or **YP_BPR** according to the input signal.

The function becomes effective only when certain signals below are input.

(VGA60, 480i, 576i, 480p, 576p, 1 080/60i, 1 080/50i, 720/60p, 720/50p)

Select the signals to be input to the **COMPUTER1** and **COMPUTER2** IN terminal.

Change setting   Change setting

AUTO	Automatic adjustment
RGB	For RGB signals
YP_BPR	For YP _B PR signals

POSITION menu

Navigating through the MENU (➔page 27), select **POSITION** from the main menu and then select the required item from the sub-menu.

- Set the selected item with ▲▼◀▶ buttons.

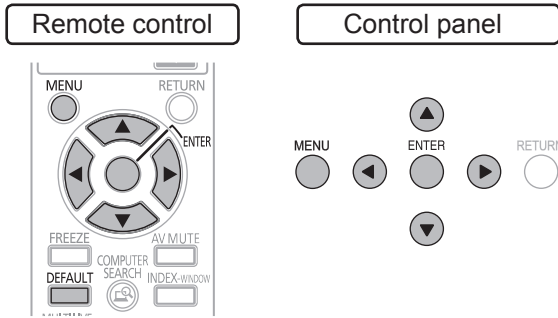

REALTIME KEYSTONE

If the projector is aligned non-perpendicularly to the screen, or if the projection screen has an angled surface, the keystone will be corrected automatically.



ON	Active
OFF	Deactive

KEYSTONE

If you need to correct the angle of the projection even when the **REALTIME KEYSTONE** is activated, you can correct the keystone manually.

Image	Operation

Remarks

- You can correct the distortion $\pm 30^\circ$ from the plane. For a better quality image, installing the projector with a minimum of distortion is recommended.
- The distortion of the Main menu screen is not correctable.
- The result of the keystone correction will affect the aspect ratio and the size of the image.

SHIFT



- Horizontal (H): Press ◀▶ buttons to move the image horizontally.
- Vertical (V): Press ▲▼ buttons to move the image vertically.

Remarks

- The image cannot be moved while network signals are input.
- Press ◀▶▲▼ buttons to move the image.

SHIFT V

(Available with signal of network only while **ASPECT** is set to **H FIT**)

Press ◀▶ buttons to move the image vertically.

DOT CLOCK

If you have interference patterns of the projected image, which is sometimes referred to as moire or noise, you can minimize it by pressing ◀▶ buttons to adjust the clock frequency.

(Available with signal of **RGB** (Still image) only).

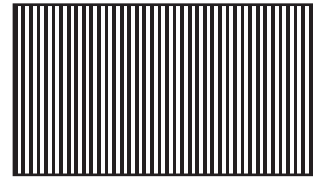

Note

- **DOT CLOCK** needs to be adjusted before adjusting the **CLOCK PHASE**.

CLOCK PHASE

If you require further adjustment for the same reason as the **DOT CLOCK** adjustment, you can fine adjust the timing of the clock. (Available with signals of **RGB/YPbPr** only)

Press ◀▶ buttons to adjust.

Remarks

- If the projecting signal's dot clock frequency is higher than 150 MHz, the adjustment of **DOT CLOCK** or **CLOCK PHASE** may not make a difference. See "List of compatible signals". (➔page 52)

OVER SCAN

Use this function when characters or pictures are cropped near the periphery of the projected image. (Available with signals of **S-VIDEO/VIDEO/RGB** (Moving image)/**YPbPr** only)



- Setting range: 0 to +3

Remarks

- **OVER SCAN** is not available when network signals are input.

ASPECT

You can switch the aspect ratio manually when needed. Selectable options vary according to input signal.

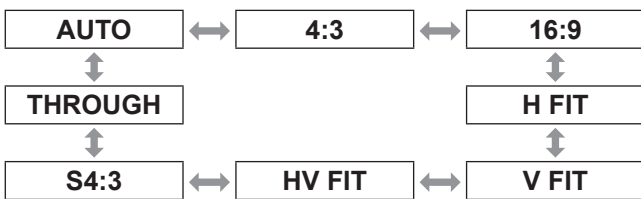

Remarks

- **AUTO** mode is displayed only when NTSC 480i signal is input.
- **THROUGH** mode is displayed only for certain signals.
- For the wide signal *2, the aspect ratio cycles through 16:9 ⇄ V FIT ⇄ HV FIT.

AUTO (Available with signal of NTSC 480i only)

The signal which contains an identifying signal will be detected and will automatically project the image in the most optimal aspect ratio.

4:3

When a standard signal *1 is input, it is projected in 4:3 aspect ratio.

- Input signal: XGA

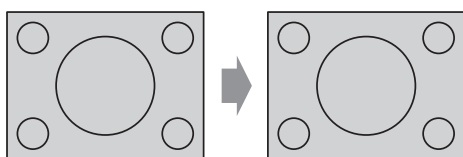

Image:

16:9

When a standard signal *1 is input, it is projected in 16:9 aspect ratio.

When a wide signal *2 is input, it is projected in the current input aspect ratio.

- Input signal: 1 080/60i

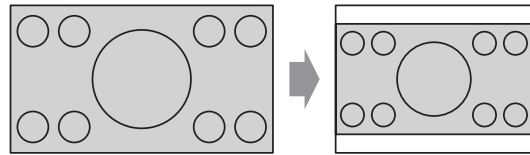

Image: Panel:

H FIT

When a standard signal *1 is input, it is projected without changing the aspect ratio, using all the panel pixels in the horizontal direction and cropping the top and bottom of the image.

- Input signal: SXGA

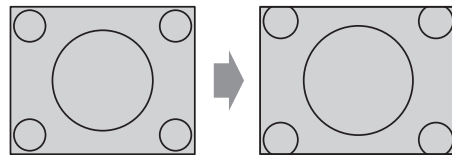

Image:

V FIT

When a wide signal *2 is input, it is projected without changing the aspect ratio, using all the panel pixels in the vertical direction and cropping the right and left of the image.

- Input signal: 1 080/60i

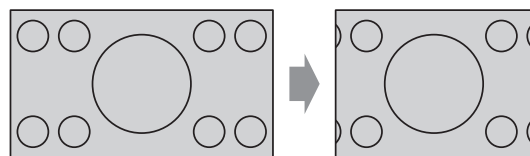

Image:

HV FIT

The image is projected all over the panel pixels (screen). The input signal is projected at the aspect ratio of the panel (screen).

- Input signal: 1 080/60i

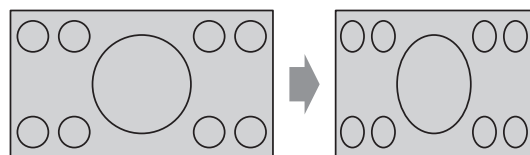

Image:

*1: A standard signal has an aspect ratio of 4:3 or 5:4.

*2: A wide signal has an aspect ratio of 16:10, 16:9 or 15:9.

POSITION menu

S4:3

When a standard signal *1 is input, the input signal will be sized down 75% and projected. **S4:3** mode is effective when projecting 4:3 image onto a 16:9 screen.

- Input signal: XGA

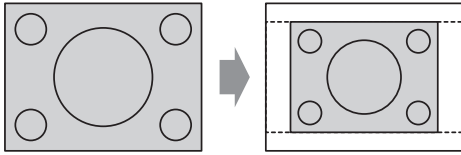

Image: Panel: Screen:

THROUGH

The image will be projected without any size adjustment.

- Input signal: NTSC

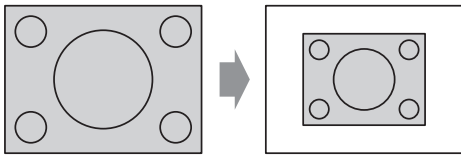

Image: Panel:

*1: A standard signal has an aspect ratio of 4:3 or 5:4.

Note

- If you project a 4:3 image onto a 16:9 screen, the image may distort or some portions may be cropped. Select an aspect ratio (4:3) which preserves the intention of the image creator.

Remarks

- The order of **ASPECT** types is defined not only by the input method but also by the input signals.
- If you project a copyrighted image enlarged or distorted by using **ASPECT** function in commercial use in a public place, such as a restaurant or hotel, you might infringe on the copyright of the creator which is protected by copyright law.

FRAME LOCK

If the projected image is degraded, you can activate **FRAME LOCK** for synchronisation. (Available with signals of **RGB** only)

Change setting   Change setting

ON	Active
OFF	Deactive

LANGUAGE menu

Navigating through the MENU (➔page 27), select LANGUAGE from the main menu and then display the sub-menu.

- Select the required language with ▲ ▼ buttons and press the ENTER button to set.

Remote control

Control panel

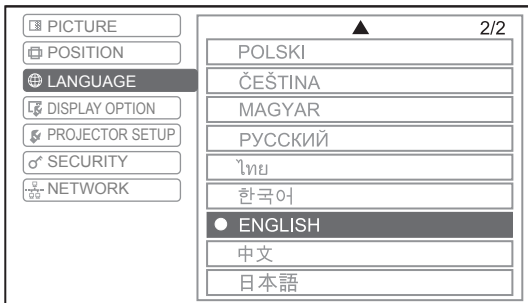
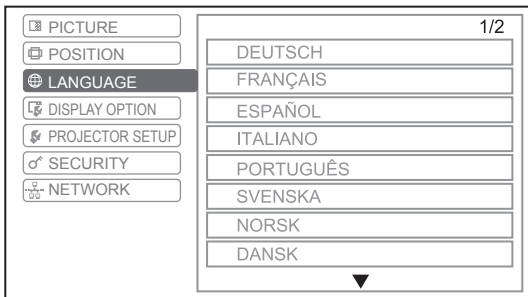
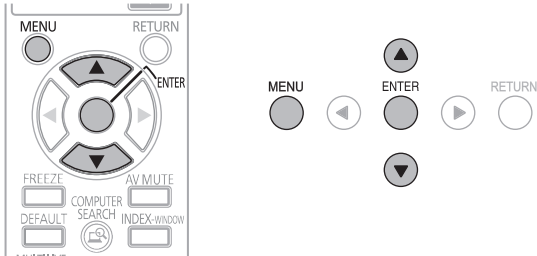

The set language is highlighted.

DISPLAY OPTION menu

Navigating through the MENU (➔page 27), select **DISPLAY OPTION** from the main menu and then select the required item from the sub-menu.

- Set the selected item with ◀▶ buttons.

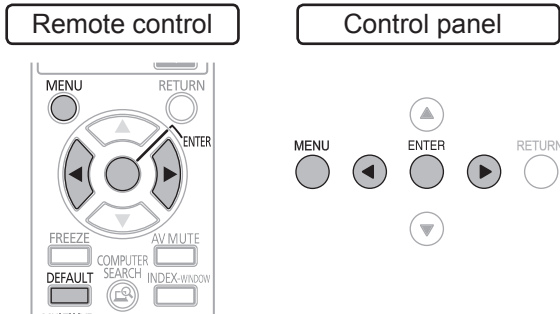

ON-SCREEN DISPLAY

You can set the on-screen display.



INPUT GUIDE

When you change the input method, the guidance appears in the upper right corner of the screen. The following display methods are available.

DETAILED	Display the input method by graphic. The INPUT GUIDE will go out after 10 seconds without any operation.
OFF	Turn off the guidance.
SIMPLE	Display the input method by text. The INPUT GUIDE will go out after 5 seconds without any operation.

Remarks

- If you select the computer terminals which have no signals while **INPUT GUIDE** is set to **DETAILED**, the computer connection guidance will be displayed. If you want to turn off the guidance, select **SIMPLE** or **OFF**.

Computer connection guidance

You can switch the signals which output from the **COMPUTER1/COMPUTER2** terminal by pressing the following computer key commands.

Manufacturer	Image output selection command	Manufacturer	Image output selection command
Panasonic NEC	Fn + F3	DELL EPSON	Fn + F8
Acer HP SHARP TOSHIBA	Fn + F5	FUJITSU	Fn + F10
lenovo SONY	Fn + F7	Apple	F7

Remarks

- The key commands are depending on the manufacturers. Please refer to the instructions which were provided with the computers for more detailed information.

OSD DESIGN

You can change the background of the on-screen menu (OSD).

TYPE1	Semi transparent black
TYPE2	Solid blue
TYPE3	Semi transparent dark blue

WARNING MESSAGE

You can choose to display or not to display the warning messages.

ON	Warning messages will be displayed
OFF	No display

Note

- When the **WARNING MESSAGE** is set to **OFF**, use the projector with utmost care due to the most of warning messages will not be displayed.

CLOSED CAPTION SETTING

If the input signal contains closed captions, you can turn on the feature and switch the channels.

CLOSED CAPTION

OFF	Deactive
ON	Active

MODE

CC1 - 4	Change the channels CC1 - 4
----------------	-----------------------------

Remarks

- VCR with TBC (Time Base Corrector) function is recommended for video cassette tapes.

STARTUP LOGO

You can set to display the Panasonic logo, your own image or Pre-set letters, when starting up the projector.





Change setting   Change setting

ON	Display "Panasonic" logo
TEXT	Display the original text
USER	Display the image registered by user
OFF	No display

Remarks

- If **TEXT** is selected, the input letters are displayed when starting up the projector. You can display 2 lines of original text which contain up to 40 characters each.
- If **USER** is selected, the image transferred by the Logo Transfer Software is displayed when starting up the projector. (You can download the Logo Transfer Software from the Panasonic Projector website (<http://panasonic.net/avc/projector/download/>.)
- **STARTUP LOGO** will be displayed for 30 seconds.

Editing the original text

- 1) Press   buttons to select **TEXT** and press the **ENTER** button.
- 2) Press   buttons to select the required line and press the **ENTER** button.
You can enter and edit the texts for the first line in **TEXT1** and the texts for the second line in **TEXT2**.



- 3) Press     buttons to select the required character and press the **ENTER** button.

To delete all the entered characters, move the cursor to **ALL DELETE** and press the **ENTER** button. To delete a character, press the **DEFAULT** button or move the cursor to the required character then press the **DEFAULT** button.

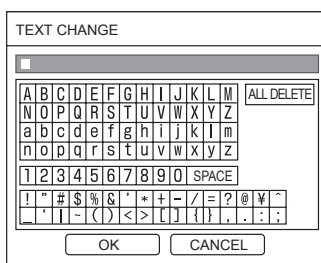

- 4) Select **OK** and press the **ENTER** button to set the entered text in a box.

- 5) Select **OK** again and press the **ENTER** button.

Select **CANCEL** or press the **MENU/RETURN** button to return to the previous menu without setting.

AUTO SETUP

You can turn off the automatic **AUTO SETUP** adjustment system.

Change setting   Change setting

AUTO	When the projector detects a COMPUTER signal, automatically set the setting of SHIFT , DOT CLOCK and CLOCK PHASE in the POSITION menu.
BUTTON	Only when the AUTO SETUP button is pressed, automatically set the SHIFT , DOT CLOCK and CLOCK PHASE in POSITION menu for COMPUTER signals. (▶page 25)

SIGNAL SEARCH

You can turn off the auto signal detecting system.

Change setting   Change setting

ON	Detect the input signal from the terminals and project the image.
OFF	Deactive

Remarks

- **SIGNAL SEARCH** is not available when any input signal is projected.

BACK COLOR

You can choose a **BLUE** or **BLACK** screen for when the projector is idle.

Change setting   Change setting

BLUE	Display blue screen
BLACK	Display black screen

DISPLAY OPTION menu

WIDE MODE

When projecting WIDE signals, switch to **ON** to display the image in well adjusted size (16:9, 16:10, 15:9).

Change setting   Change setting

AUTO	Automatic setting
OFF	For 4:3 signals
ON	For WIDE signals

SXGA MODE

Switch to the **SXGA** setting when inputting SXGA signal.

Change setting   Change setting

SXGA	For normal projection
SXGA+	For projection when image is cropped

OTHER FUNCTIONS

You can perform some of the remote control button operations from the sub-menu.

■ AUTO SETUP

For details, see “Setting up the image position automatically”. (➔page 25)

■ FREEZE

You can capture the projected image and see it as a still picture. While the image is frozen, the audio sound through the projector will stop. Press the **RETURN** button to escape.

■ AV MUTE

If you will not be using the projector for some time, you can stop the projection and audio sound temporarily. Press the **RETURN** button to escape.

■ INDEX-WINDOW

For details, see “INDEX-WINDOW display”. (➔page 25)

■ DIGITAL ZOOM

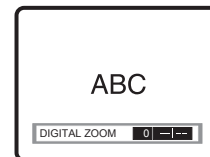

▶ button: zooms in

◀ button: zooms out

Press the **ENTER** button to select the enlargement range.

Press the **RETURN** button to escape.

PROJECTOR SETUP menu

Navigating through the MENU (▶page 27), select **PROJECTOR SETUP** from the main menu and then select the required item from the sub-menu.

- Set the selected item with ◀▶ buttons.

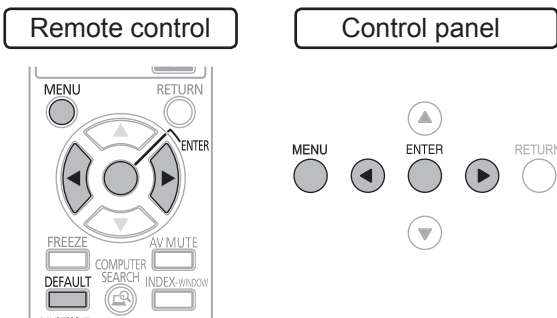

STATUS

You can check the using status of the projector.

SIGNAL

- NAME: Name of input signal
- FREQUENCY: Scanning frequency of input signal

RUNTIME

- PROJECTOR: Display current usage time of projector
- LAMP: Display current usage time of lamp

NO SIGNAL SHUT-OFF

If no image signal is input for the time set with the timer, the projector will enter into standby mode automatically.

Change setting ◀▶ Change setting

DISABLE	NO SIGNAL SHUT-OFF is disabled
15 - 60 MIN.	Timer can be set in intervals of 5 minutes

INITIAL START UP

You can set the starting method when the power plug is connected to wall outlet.

Change setting ◀▶ Change setting

LAST MEMORY	Projector starts from the last image before the power plug was disconnected
STANDBY	Projector starts in the standby mode
ON	Projector starts immediately

INSTALLATION

When installing the projector, select the projection method according to the projector position. (▶page 16)

Change setting ◀▶ Change setting

FRONT/DESK	Setting on a desk/floor and projecting from front
FRONT/CEILING	Mounting in the ceiling with a ceiling mount bracket (sold separately) and projecting from front
REAR/DESK	Setting on a desk/floor and projecting from rear (Translucent screen is required)
REAR/CEILING	Mounting in the ceiling with a ceiling mount bracket (sold separately) and projecting from rear (Translucent screen is required)

HIGH ALTITUDE MODE

If you use the projector at high elevation, the **HIGH ALTITUDE MODE** setting need to be **ON** to set the fan speed high.

Change setting ◀▶ Change setting

OFF	For use in normal environment
ON	For use at high altitude

Remarks

- At 1 400 -2 700 m (4 593 - 8 858 ft) sea level, the setting must be **ON**.
- The loudness of fan noise depends on the **HIGH ALTITUDE MODE** setting.

PROJECTOR SETUP menu

STANDBY MODE

You can change the standby mode setting.



ECO	The standby power is reduced to 0.9 W to save power.
NORMAL	The power of the projector can be turned ON and the audio output can be set active from controlling the computer connected via a wired LAN or a wireless LAN in the NORMAL mode.

LAMP POWER

You can adjust the power of the lamp to save electricity, prolong the lamp life and reduce the noise.



NORMAL	When higher luminance is required
ECO	When lower luminance is sufficient

Remarks

- When no input signal is detected, this function is disabled.
- The **ECO** setting is recommended when higher luminance is not required such as in a small room.

LAMP RUNTIME

You can check how long the lamp has been used.

Note

- **LAMP RUNTIME** is a relevant matter for lamp replacement timing. See "Replacing the Lamp unit" (➡page 48).
- Check the lamp unit replacement time. (➡page 48)

Remarks

- If the lamp runtime has reached 2 800 hours, the red (time indicator) and gray marks appear alternately to notify you of the lamp replacement time.
- The lamp life varies with its condition of use (number of power-on times, etc.).

EMULATE

When the projector is controlled with a computer through serial input terminal, you can change the setting to use the former projector control commands.

- 1) Press the **ENTER** button.
- 2) Press **▲ ▼** buttons to select the required setting.
- 3) Press the **ENTER** button.

• DEFAULT	LB75 Series LB78 Series LB80 Series LB90 Series
D3500	D3500
D4000	D4000
D/W5K series	D5500 Series DW5000 Series D5600 Series DW5100 Series D5700 Series
D/W/Z6K series	D5000 Series D6000 Series DW6300 Series DZ6700 Series DZ6710 Series
L730	L520 Series L720 Series L730 Series
L780	L750 Series L780 Series
L735	L735 Series
L785	L785 Series
F/W series	F100 Series FW100 Series F200 Series F300 Series FW300 Series

FUNCTION BUTTON

You can select a useful function from the list and assign it to the **FUNCTION** button as a short-cut.

- 1) Press the **MENU** button of the control panel or remote control to display the on screen menu (main menu, sub-menu or detailed menu).

For the menu operation, see "Navigating through the MENU". (▶page 27)

- 2) Press and hold the **FUNCTION** button of the control panel or remote control for at least 3 seconds.

●When not using the FUNCTION button

- 1) Select **DISABLE** in this menu (**FUNCTION BUTTON** in the **PROJECTOR SETUP** menu).
- 2) Press the **ENTER** button.
- 3) Select **OK**.
- 4) Press the **ENTER** button.

Remarks

- After the setting is completed, the text color and button color will change.
- You can assign all the menu items, excluding the sub-menu of the **SECURITY** menu (**PASSWORD**, **PASSWORD CHANGE**, **TEXT DISPLAY**, **TEXT CHANGE**, **MENU LOCK**, **MENU LOCK PASSWORD** and **CONTROL DEVICE SETUP**).
- The displayed menu screen will disappear after 5 seconds without any operation, and the setting will be confirmed.

AUDIO SETTING

You can perform more detailed setting for Audio.

■ VOLUME

You can adjust the volume of the built-in monaural speaker and **VARIABLE AUDIO OUT** terminal.



■ BALANCE

You can adjust to hear the sound played equally through both right and left external stereo speakers, or shift the balance so more sound plays through the left or right side.



■ IN STANDBY MODE

You can turn ON or OFF the audio output in the standby mode.



OFF	Deactive
ON	Active

Remarks

- When **STANDBY MODE** is set to **ECO**, the audio output cannot be activated in the standby mode.

■ POWER BUTTON BEEP

You can set the operational sound (beep) heard when the power is turned off/on.



OFF	When the power is turned off/on *, the operational sound (beep) is not heard.
ON	When the power is turned off/on, the operational sound (beep) is heard.

*: The operational sound is heard when the button on the control panel is pressed after the power is connected.

■ AUDIO IN SELECT

You can select to connect the audio input of the devices connected to **COMPUTER1/COMPUTER2** to the **COMPUTER AUDIO IN** or **AUDIO IN** terminal.



AUDIO IN SELECT	
COMPUTER1 IN	Select COM. AUDIO IN or AUDIO IN terminal
COMPUTER2 IN	Select COM. AUDIO IN or AUDIO IN terminal

PROJECTOR SETUP menu

TEST PATTERN

You can use the 7 different test patterns to adjust the focus of the image. Press the **ENTER** button to display the test pattern.



Press the **MENU** or **RETURN** button to return to the **PROJECTOR SETUP** menu, or press repeatedly to escape the menu mode.

Remarks

- The initial screen is an all white pattern. Only when **TEST PATTERN** is assigned to the **FUNCTION** button, the lattice pattern will display in the initial screen.

INITIALIZE ALL

You can reset all of the customised settings in the **MENU** to the factory defaults.

- If the **ENTER** button is pressed in the **INITIALIZE ALL** menu, **INITIALIZE ALL** will display. Select **OK** and press the **ENTER** button, **NOW INITIALIZING...** is displayed. Then, **POWER OFF** is displayed. Select **OK** and turn off the power according to the instruction. (All other buttons are deactivated.)
- The **INITIAL SETTING** menu screen will display when the power is connected.
(➔page 11)

Remarks

- The usage time of the projector, lamp runtime and the **NETWORK** settings are not initialised.
- When **PASSWORD** in **SECURITY** menu is activated, be sure to enter the correct password when initialised.
- After **INITIALIZE ALL** operation is completed, the password is reset to the factory default setting and **PASSWORD** setting is turned **OFF**.

SECURITY menu

Navigating through the MENU (➔page 27), select **SECURITY** from the main menu and then select the required item from the sub-menu.

- When you apply to the **SECURITY** menu for the first time, you will be asked to perform the password operation. Input the initial password by pressing ▲▶▼◀▲▶▼◀ buttons in order and then press the **ENTER** button.
- Set the selected item with ◀▶ buttons.

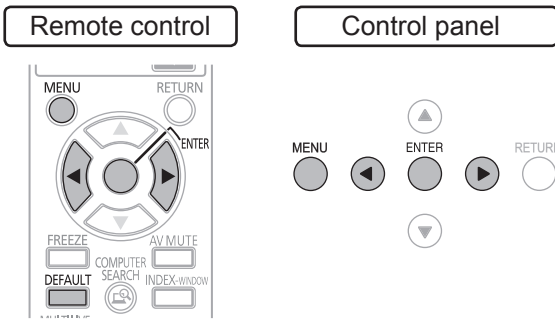

Note

- Perform the above operation after the **SECURITY** menu is displayed.
- If you have changed the password, input the new password and press the **ENTER** button.

PASSWORD

You can activate the security system and the password operation will be asked to perform when projecting mode started.

Change setting ◀▶ Change setting

OFF	Deactive
ON	Active

Remarks

- **PASSWORD** is set to **OFF** by default and when initialised.
- Change your password regularly. Do not use a simple password that is too easy to guess.
- Unless you perform the correct password operation, all of the button controls will be disabled except the **POWER** button.

PASSWORD CHANGE

You can change the password operation to your original.

- 1) Press ▲ ▼ ◀ ▶ buttons to change the password.
(Up to eight button operations can be set.)
- 2) Press the **ENTER** button.
- 3) Input the password again and press the **ENTER** button.

Remarks

- The entered password operations will appear as asterisks in the box.
- If a series of button operation is incorrect, you will be asked to perform again.

TEXT DISPLAY

You can set your original text to display regularly at the bottom of the projected image while projecting.

Change setting ◀▶ Change setting

OFF	Deactive
ON	Active

TEXT CHANGE

You can enter your original text to be displayed when **TEXT DISPLAY** is turned **ON**.

- 1) Press ▲ ▼ ◀ ▶ buttons to select the required character and press the **ENTER** button.
(You can input up to 22 characters.)

To delete all the entered characters, move the cursor to **ALL DELETE** and press the **ENTER** button. To delete a character, press the **DEFAULT** button or move the cursor to the required character then press the **DEFAULT** button.

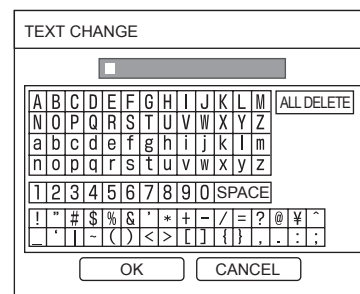

- 2) Press ▲ ▼ ◀ ▶ buttons to select **OK** and press the **ENTER** button.
Select **CANCEL** or press the **MENU/RETURN** button to return to the previous menu without setting.

SECURITY menu

MENU LOCK

Press the **MENU** button to display the menu. You can lock or unlock the menu operation.



OFF	Unlock the menu operation
ON	Lock the menu operation

Remarks

- Once **MENU LOCK** is set to **ON**, you cannot use the **MENU** button unless you input the correct password.
- The **MENU LOCK** is set to **OFF** by default and when initialised.

MENU LOCK PASSWORD

When **MENU LOCK** is set to **ON**, you can set a **MENU LOCK PASSWORD**.

1) Press **▲ ▼ ◀ ▶** buttons to select the required character and press the **ENTER** button.

(You can input up to 16 characters.)

To delete all the entered characters, move the cursor to **ALL DELETE** and press the **ENTER** button. To delete a character, press the **DEFAULT** button or move the cursor to the required character then press the **DEFAULT** button.

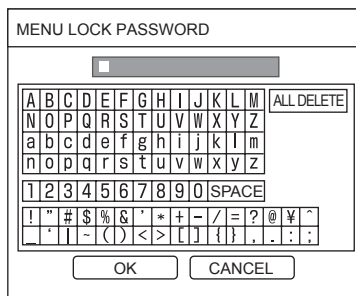

2) Press **▲ ▼ ◀ ▶** buttons to select **OK** and press the **ENTER** button.

Select **CANCEL** or press the **MENU/RETURN** button to return to the previous menu without setting.

Remarks

- When using the projector for the first time or after **INITIALIZE ALL** operation is activated, the initial password is set as **AAAA**.
- Change your password regularly. Do not use a simple password that is too easy to guess.
- To reset the password to the initial password, see "MENU LOCK PASSWORD" (➔page 54).

CONTROL DEVICE SETUP

You can enable/disable the button operations of the control panel and remote control.



CONTROL PANEL

ENABLE	Enable the button operations
DISABLE	Disable the button operations

REMOTE CONTROLLER

ENABLE	Enable the button operations
DISABLE	Disable the button operations

Remarks

- If **DISABLE** is set, the confirmation screen appears. Select **OK** and press the **ENTER** button.
- If any button is pressed when **DISABLE** is set, the password screen appears. Input the password which is set in the **SECURITY** menu.
- The **PASSWORD** screen will be displayed for 10 seconds.
- If you set both **CONTROL PANEL** and **REMOTE CONTROLLER** to **DISABLE**, all the button operations of the control panel and remote control are disabled and you cannot turn off the power.
- In the standby mode, press and hold the **ENTER** button of the control panel and **MENU** button for at least 2 seconds. The buttons on the control panel are enabled. You can also enable the button operation by pressing and holding the **ENTER** button of the control panel and **MENU** button for at least 2 seconds while the projector is projecting.

NETWORK menu (PT-LB90NTU only)

Navigating through the MENU (➔page 27), select **NETWORK** from the main menu and then select the required item from the sub-menu.

- Set the selected item with ◀▶ buttons.

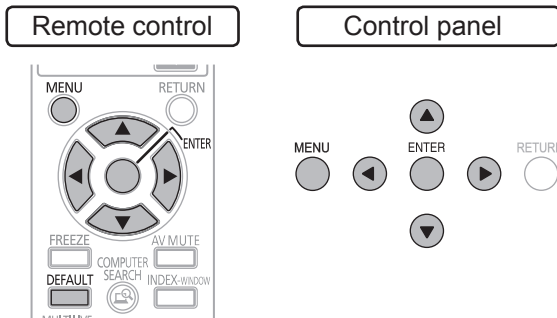

Remarks

- These items are set for network connection with a computer. For details of the PJ Link and network, see “NETWORK operation manual” in the CD-ROM provided.

WIRED LAN

You can set a wired LAN.

WIRELESS LAN

You can set a wireless LAN.

NAME CHANGE

You can change the name of the projector.

INPUT PASSWORD

When checking the password for the network connection, you must turn this function **ON**.

PASSWORD CHANGE

You can change the password for the network connection.

NETWORK CONTROL

When controlling the projector with a computer on the network, you must turn this function **ON**.

LIVE MODE CUT IN

Set this function to **ON** to allow other users to connect to live mode while the projector is operating in the live mode of the network.

COMPUTER SEARCH

You can search for a computer on the network.

MULTI-LIVE

This function is available when a network input signal is detected.

STATUS

You can display the status of the network setting.

INITIALIZE

You can reset the settings of the network to the factory default settings.

Remarks

- When **PASSWORD** in the **SECURITY** menu is activated or the network setting is initialised, you will be required to input the password.

LAMP and TEMP Indicators

Managing the indicated problems

If a problem should occur with the projector, the **LAMP** and/or **TEMP** indicators will inform you. Manage the indicated problems as follows.

Note

- When managing a problem, be sure to turn off the power as described in “Switching off the projector”. (➔page 22)

Remarks

- Confirm the power supply status by the **POWER** indicator. (➔page 20)

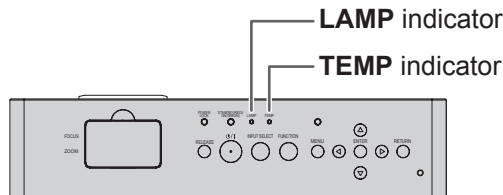

LAMP indicator

Indicator	● Illuminating red	● Flashing red
Problem	LAMP RUNTIME has reached 2 800 hours.	LAMP circuit failure, abnormal function or the lamp unit is damaged.
Cause	Lamp unit will run out soon and needs to be replaced.	The projector is switched on again too soon.
Remedy	See “Replacing the Lamp unit”. (➔page 48)	Let the lamp unit cool down and turn on the projector after 90 seconds.
		LAMP circuit failure, abnormal function.
		Switch off the projector (➔page 22) and contact an Authorized Service Center.
		Lamp unit is damaged.
		See “Replacing the Lamp unit”. (➔page 48)

Remarks

- If the **LAMP** indicator still lights or flashes after the above remedy, contact an Authorized Service Center.

TEMP indicator

Indicator	<ul style="list-style-type: none"> Illuminating red while projecting and the alert will be displayed. Flashing red and power is turned off. 			
Problem	The temperature inside and/or outside the projector is abnormally high. <ul style="list-style-type: none"> The projection may become darker than usual. The internal fan operational noise may be louder than usual. 			
Cause	The air outlet port and air intake ports are covered.	The room temperature is too high.	The filter is excessively dirty and the ventilation is poor.	The projector is located at 1 400 - 2 700 m (4 593 - 8 858 ft).
Remedy	Remove the object(s) from the air outlet port and air intake ports or clear around the projector.	Reinstall the projector in temperature controlled place. (➔page 56)	Clean the filter in the proper method. (➔page 47)	Turn on the projector*1 and set the HIGH ALTITUDE MODE to ON . (➔page 39)

*1: The projector will perform 2 minutes with **OFF** setting at high elevation.

Remarks

- Take the above remedy, disconnect the power plug, and then supply the power again. If the **TEMP** indicator still lights or flashes after the above remedy, contact an Authorized Service Center.
- If the environment temperature in the projector rises, the fan speed increases and the sound becomes louder.

Care and Replacement

Before Care and Replacement

- Before cleaning, be sure to turn off the power and disconnect the power plug from the wall outlet. (▶page 19)
- Be sure to turn off the power as described in “Switching off the projector”. (▶page 22)

Cleaning the projector

■ Cabinet

Wipe off dirt and dust gently with a soft cloth.

- If it is difficult to remove the dirt, soak a cloth with water, wring the cloth well and then wipe the projector. Dry off the projector with dry cloth.
- Do not use petroleum benzine, thinner, any alcoholic solvent, kitchen detergents or chemical clothes. Failure to observe these may result in altered or damaged surfaces of the projector.

■ Lens cover

Make sure no dirt or dust remains on the surface of the lens cover glass. It will be enlarged and projected onto the screen.

Wipe off dirt and dust gently with a lint-free cloth. Do not wipe the lens cover with a cloth which has collected dust.

Note

- Clean the lens cover with special care. Giving a shock may cause serious damage.

■ Air filter

If the air filter is excessively dirty, the internal temperature of the projector increases, the **TEMP** indicator lights, and the power is turned off. If the power is turned off, the **TEMP** indicator flashes. Clean the air filter regularly every 100 hours of usage.

1) Turn the projector upside down and place it gently on a soft cloth.

- Place the projector softly so that it will not be damaged.
- Press the tab and slightly slide up the air filter to remove.

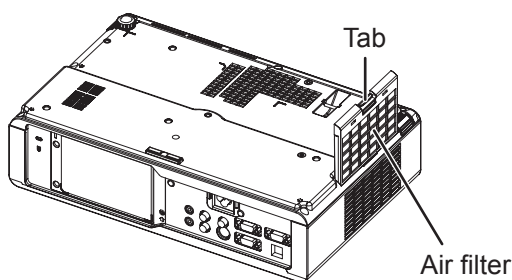

2) Clean the air filter.

Vacuum dirt and dust from the air filter.

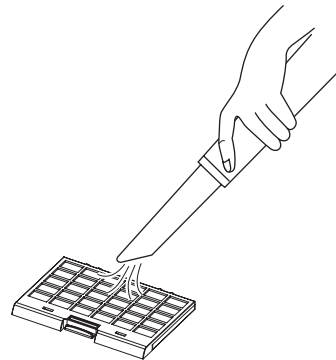

3) Install the air filter.

Remarks

- Do not use the projector without attaching the air filter. Otherwise, it will suck in dirt and dust which can cause malfunction.

Care and Replacement

Replacing the Lamp unit

Air filter

The air filter should be replaced when cleaning is ineffective and when replacing the lamp unit. A replacement air filter is provided with a replacement lamp unit (ET-LAB80). Contact an Authorized Service Center for the optional air filter (TXFMZ01VKG7).

Lamp unit

The lamp unit, ET-LAB80 is consumable and you must replace it regularly. It is recommended that a qualified technician carry the lamp unit replacement and consult with an Authorized Service Center.

Note on lamp unit replacement

- Handle the lamp unit with special care as it is a glass product. Dropping or giving it a shock may cause it to burst or to be damaged.
- If you wish to discard the used lamp, please contact your local authorities or dealer and ask for the correct method of disposal.
- Prepare a Phillips-head screwdriver.
- When replacing the lamp unit, be sure to hold it by the handle.
- Hold the lamp unit horizontally to prevent broken pieces from scattering. When the projector is mounted in the ceiling, do not work directly under the projector or put your face close to the projector, and pull out the lamp horizontally.

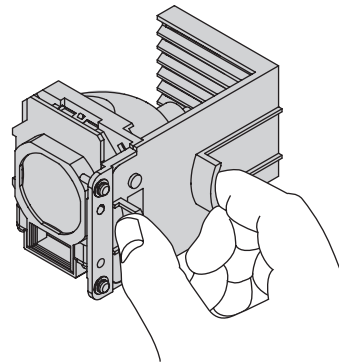

Note



- Prior to replacing the lamp unit, allow it to cool down to prevent the risk of burns, damage and other hazards.

Remarks

- Do not attempt replacement with an unauthorized lamp unit.

Lamp unit replacement time

When the lamp is consumed, the brightness may decrease over time. 3 000 hours of use is the replacing time as a rough guide, and that might be shortened by the usage conditions, characteristics of the lamp unit or environmental conditions. You can find the duration of usage time by checking **LAMP RUNTIME** in the **PROJECTOR SETUP** menu. Do not use a lamp unit over 3 000 hours. Failure to observe this may result in explosion of the lamp.

	ON-SCREEN DISPLAY	LAMP indicator
		
2 800 hours	Displays "REPLACE LAMP" on the upper left of the screen for 30 seconds. If any button is pressed within 30 seconds, the message disappears.	Illuminates red, even in the standby mode.
3 000 hours	Displays "REPLACE LAMP" on the upper left of the screen, and it will stay until you respond. The power is turned off automatically in 10 minutes.	

Remarks

- The guide time, 3 000 hours, is a rough estimate based on certain conditions and is not a guaranteed time.

Lamp replacement procedure

- When the projector is mounted in the ceiling, do not work directly under the projector or put your face close to the projector.
- Be sure to install the lamp unit and attach the lamp unit cover securely. If they are not installed securely, it may cause the protection circuit to operate so that the power cannot be turned on.

- 1) **Disconnect the power plug from the wall outlet according to “Switching off the projector” (➔page 22), wait for at least 1 hour, and check if the lamp unit bottom is cooled.**
- 2) **Use a Phillips-head screwdriver to loosen the 2 lamp unit cover fixing screws on the back of the projector until the screws turn loose, and remove the lamp unit cover.**

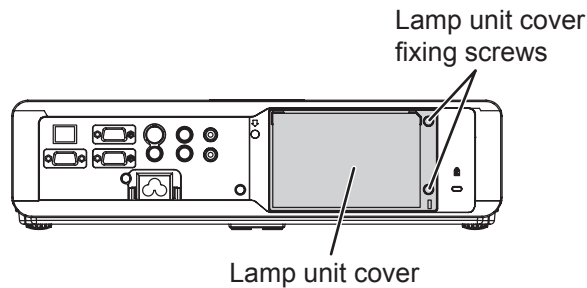

- 3) **Use a Phillips-head screwdriver to loosen the 3 lamp unit fixing screws. Pull the used lamp unit gently from the projector.**

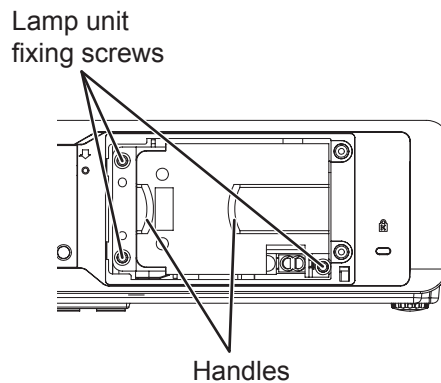

- 4) **Press in the lamp unit until it clicks and make sure the unit is installed securely. Tighten the 3 lamp unit fixing screws securely with a Phillips-head screwdriver.** When inserting, in particular press the portion of (A) securely.

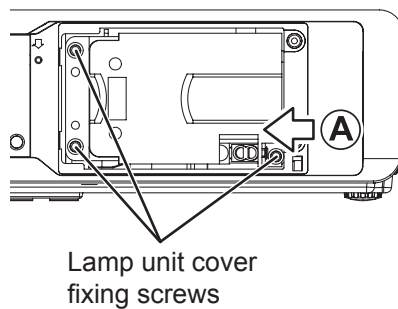

Care and Replacement

- 5) Attach the lamp unit cover and tighten the 2 lamp unit cover fixing screws securely with a Phillips-head screwdriver.
- 6) Connect the power cord to a wall outlet.
- 7) Press the **POWER** button and the projection starts.

Remarks

- If **INITIAL START UP** in the **PROJECTOR SETUP** menu is set to **ON**, the projector starts projecting when the power cord is connected to a wall outlet. (▶page 39)
- 8) Press the **MENU** button to display the main menu and press **▲ ▼** buttons to scroll to the **PROJECTOR SETUP** menu.
 - 9) Press the **ENTER** button to select the **PROJECTOR SETUP** menu and press **▲ ▼** buttons to select **LAMP RUNTIME**.
 - 10) Press and hold the **ENTER** button for approximately 3 seconds.
 - The **LAMP RUNTIME** confirmation screen is displayed.

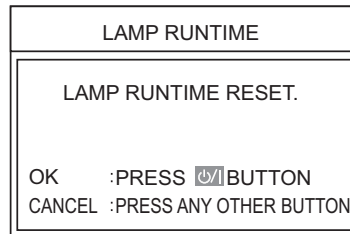

Note

- If any button other than the **POWER** button is pressed, the **LAMP RUNTIME** screen disappears and the lamp runtime is not reset. (Repeat from step 8 again).
- 11) Press the **POWER** button.
 - After the lamp goes off, projection stops and the **POWER** button lights in red, then disconnect the power plug.
 - 12) The lamp runtime is reset to “0”.

Troubleshooting

Confirm the following problem and cause.
Should any problem persist, contact an Authorized Service Center.

Problem	Cause	Page
Power does not turn on.	● The power cord may not be connected securely.	19
	● No electric supply at the wall outlet.	21
	● The circuit breakers have tripped.	—
	● TEMP or LAMP indicator is lit or flashes.	46
	● The lamp unit cover has not been securely installed.	49
	● The control buttons are LOCKED .	44
	● CONTROL PANEL in the PROJECTOR SETUP menu is invalidated.	44
No picture appears.	● The audio signal source may not be connected properly.	17, 18
	● The input selection setting may not be correct.	23
	● The BRIGHTNESS adjustment setting may be at the minimum setting.	30
	● The signal input source may not be operating properly.	—
	● The AV MUTE function may be in use.	24
The picture is fuzzy.	● The lens focus may not have been set correctly.	23
	● The projector may not be at the correct distance from the screen.	15
	● The lens may be dirty.	47
	● The projector may be tilted too much.	15
Color is pale or grayish.	● COLOR or TINT adjustment may be incorrect.	30
	● The input source which is connected to the projector may not be adjusted correctly.	—
No sound can be heard from the internal speaker.	● The audio signal source may not be connected properly.	17, 18
	● The volume adjustment may be at the lowest possible setting.	25, 41
	● A cable may be connected to the VARIABLE AUDIO OUT terminal.	13
The remote control does not operate.	● The batteries may be weak.	—
	● The batteries may not have been inserted correctly.	14
	● The remote control signal receptor on the projector may be obstructed.	14
	● The remote control unit may be out of the operation range.	14
	● REMOTE CONTROLLER in the PROJECTOR SETUP menu is invalidated.	44
	● The remote control is under a strong light such as fluorescent.	14
The control buttons of the projector do not operate.	● CONTROL PANEL in the PROJECTOR SETUP menu is invalidated. (If you have a loss of the remote control while the CONTROL PANEL is invalidated, press and hold the MENU button for 2 seconds by pressing the ENTER button.)	44
The picture does not display correctly.	● The signal format (TV-SYSTEM , RGB/YPbPr) may not have been set correctly.	31
	● There may be a problem with the VCR or other signal source.	—
	● A signal which is not compatible with the projector is being input.	52
Picture from a computer does not appear.	● The RGB signal cable is too long. (Limit to 10 m (32'10").)	—
	● The external video output from a laptop computer may not be correct. (You may be able to change the external output settings by pressing the [Fn] + [F3] or [Fn] + [F10] keys simultaneously. The actual method varies depending on the type of computer; refer to the documentation provided with your computer for further details.)	36
The projector cannot be controlled through serial terminal.	● EMULATE in the PROJECTOR SETUP menu is not set correctly. (If you fail to select your product series, ask your dealer for repair.)	40

Note

- If the projector does not operate normally after the above remedies are taken, contact an Authorized Service Center.

Technical Information

List of compatible signals

This projector can project the following image signals.

Mode	Display resolution (dots) *1	Scanning frequency		Dot clock frequency (MHz)	Picture quality *2	PnP availability *3	Terminals
		H (kHz)	V (Hz)				
NTSC/NTSC4.43/ PAL-M/PAL60	720 × 480i	15.7	59.9	—	A		VIDEO/S-VIDEO
PAL/PAL-N/SECAM	720 × 576i	15.6	50	—	A		
525i (480i)	720 × 480i	15.7	59.9	13.5	A		COMPUTER/ YP _B PR
625i (576i)	720 × 576i	15.6	50	13.5	A		
525p (480p)	720 × 483	31.5	59.9	27	A		
625p (576p)	720 × 576	31.3	50	27	A		
1 125 (1 080)/60i	1 920 × 1 080i	33.8	60	74.3	A		
1 125 (1 080)/50i	1 920 × 1 080i	28.1	50	74.3	A		
750 (720)/60p	1 280 × 720	45	60	74.3	A		
750 (720)/50p	1 280 × 720	37.5	50	74.3	A		
VESA	640 × 400	31.5	70.1	25.2	A		COMPUTER
	640 × 400	37.9	85.1	31.5	A		
VGA	640 × 480	31.5	59.9	25.2	A	○	
	640 × 480	35	66.7	30.2	A	○	
	640 × 480	37.9	72.8	31.5	A	○	
	640 × 480	37.5	75	31.5	A	○	
	640 × 480	43.3	85	36	A		
SVGA	800 × 600	35.2	56.3	36	A	○	
	800 × 600	37.9	60.3	40	A	○	
	800 × 600	48.1	72.2	50	A	○	
	800 × 600	46.9	75	49.5	A	○	
	800 × 600	53.7	85.1	56.3	A		
MAC	832 × 624	49.7	74.6	57.3	A	○	
XGA	1 024 × 768	39.6	50.1	51.9	AA		
	1 024 × 768	48.4	60	65	AA	○	
	1 024 × 768	56.5	70.1	75	AA	○	
	1 024 × 768	60	75	78.8	AA	○	
	1 024 × 768	68.7	85	94.5	AA		
MXGA	1 152 × 864	64	71.2	94.2	A	○	
	1 152 × 864	67.5	74.9	108	A		
	1 152 × 864	76.7	85	121.5	B		
MAC	1 152 × 870	68.7	75.1	100	A	○	
MSXGA	1 280 × 960	60	60	108	A	○	
SXGA	1 280 × 1 024	64	60	108	A		
	1 280 × 1 024	80	75	135	B	○	
	1 280 × 1 024	91.1	85	157.5	B		
SXGA60+	1 400 × 1 050	64	60	108	A		
	1 400 × 1 050	65.1	59.9	122.4	B	○	
UXGA	1 600 × 1 200	75	60	162	B	○	
WIDE750 (720)	1 280 × 720	44.8	59.9	74.5	A	○	
	1 280 × 720	37.1	49.8	60.5	A		
WXGA768	1 280 × 768	39.6	49.9	65.3	A		
	1 280 × 768	47.8	59.9	79.5	A	○	
WXGA800	1 280 × 800	41.3	50	68	A		
	1 280 × 800	49.1	60.2	69.1	A	○	
	1 280 × 800	49.7	59.8	83.5	A		
WXGA+	1 440 × 900	55.9	59.9	106.5	A	○	
WSXGA+	1 680 × 1 050	65.3	60	146.3	B	○	
WUXGA	1 920 × 1 200	74.6	59.9	193.3	B		

*1: The "i" appearing after the resolution indicates an interlaced signal.

*2: The following symbols are used to indicate picture quality.

AA: Maximum picture quality can be obtained.

A : Signals are converted by the image processing circuit before picture is projected.

B : Some loss of data occurs to make projection easier.

*3: The signals marked with circles (○) can be applied by plug-and-play device.

Serial terminal

The serial connector which is on the connector panel of the projector conforms to the RS-232C interface specifications, so that the projector can be controlled by a personal computer which is connected to this connector.

Connection

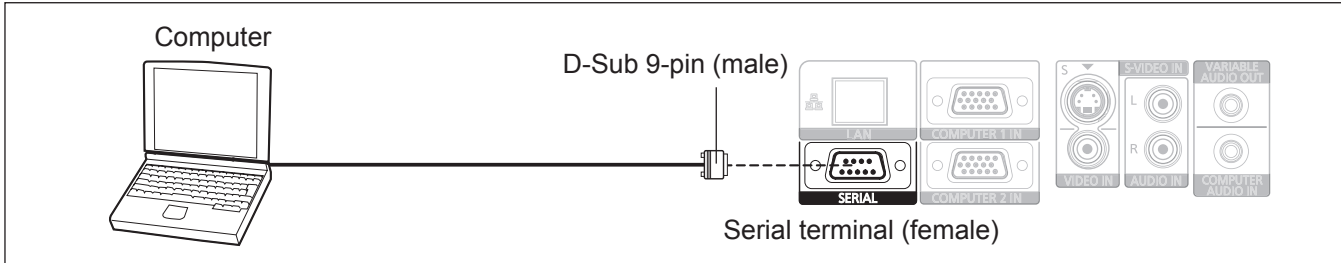

Pin assignments and signal names

	Pin No.	Signal name	Contents
	①		NC
	②	TXD	Transmitted data
	③	RXD	Received data
	④		NC
	⑤	GND	Earth
	⑥		NC
	⑦	RTS	Connected internally
	⑧	CTS	
	⑨		NC

Communication settings

Signal level	RS-232C
Sync.method	Asynchronous
Baud rate	9 600 bps
Parity	None

Character length	8 bits
Stop bit	1 bit
X parameter	None
S parameter	None

Basic format

<table border="1" style="width: 100%; border-collapse: collapse;"> <tr> <td style="width: 15%; text-align: center;">STX</td> <td style="width: 35%; text-align: center;">Command</td> <td style="width: 5%; text-align: center;">:</td> <td style="width: 35%; text-align: center;">Parameter</td> <td style="width: 10%; text-align: center;">ETX</td> </tr> <tr> <td style="text-align: center;">Start byte (02 h)</td> <td style="text-align: center;">3 bytes</td> <td style="text-align: center;">1 byte</td> <td style="text-align: center;">1 byte - 4 bytes</td> <td style="text-align: center;">End (03 h)</td> </tr> </table>	STX	Command	:	Parameter	ETX	Start byte (02 h)	3 bytes	1 byte	1 byte - 4 bytes	End (03 h)	<p>The data streaming from the computer will start with STX, and proceed to Command, Parameter and end with ETX. You can add the required parameter.</p>
STX	Command	:	Parameter	ETX							
Start byte (02 h)	3 bytes	1 byte	1 byte - 4 bytes	End (03 h)							

Note

- The projector can not receive any command for 10 seconds after the lamp is switched on. Wait for 10 seconds before sending the command.
- If sending multiple commands, check if a response has been received from the projector for one command before sending the next command.
- When a command which does not require parameters to be sent, the colon (:) is not required.

Remarks

- If an incorrect command is sent from the personal computer, the ER401 command will be sent from the projector to the personal computer.

Technical Information

Cable specifications

(When connected to a personal computer)

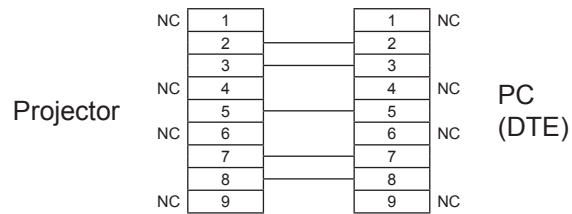

Control commands

The following commands are used for control of the projector with a computer.
(Operation commands)

Command	Control contents	Remarks
PON	Power on	<ul style="list-style-type: none"> The PON command is ignored during lamp ON control. If a PON command is received while the cooling fan is operating after the lamp has switched off, the lamp is not turned back on again straight away in order to protect the lamp.
POF	Power off	
AVL	Volume	Parameter: 000 - 063 (Adjustment value 0 - 63)
IIS	Input	Parameter: VID = VIDEO SVD = S-VIDEO RG1 = COMPUTER 1 IN RG2 = COMPUTER 2 IN NWP = NETWORK (PT-LB90NTU only)
Q\$\$	Lamp condition query	Call back: 0 = Standby 1 = Lamp on control active 2 = Lamp on 3 = Lamp off control active
OSH	AV mute	Turning off the projection and sound temporarily. Send the command to switch between off and on. (▶page 24) Do not send the command consecutively. 0 = Off 1 = On

Remarks

- If **STANDBY MODE** is set to **ECO**, only **PON** and **Q\$\$** command can be used in the standby mode.

LAN terminal

Name and function of LAN terminal

LINK lamp (Yellow)
10 Base-T/100 Base-TX
light up when connected.

ACT lamp (Green)
Flashing when data are transmitted or received.

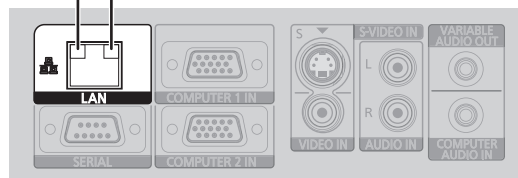

Note

- Do not touch the LAN terminal or the metal part of the LAN cable.
Otherwise, the static electricity may discharge from our hand (body) and thus cause a malfunction.

MENU LOCK PASSWORD

To initialize your password, consult your distributor.

Specifications

The specifications of this projector are as follows.

Power supply		AC 100 - 240 V 50 Hz/60 Hz
Power consumption		300 W During standby (when fan is stopped): Approx. 0.9 W
Amps		3.7 A - 1.5 A
LCD panel	Panel size (diagonal)	0.63 type (16.00 mm)
	Aspect ratio	4:3
	Display method	3 transparent LCD panels (RGB)
	Drive method	Active matrix method
	Pixels	786 432 (1 024 × 768) × 3 panels
Lens		Manual zoom (1.2×)/Manual focus F 1.65 - 1.93, f 18.53 mm - 22.18 mm
Lamp		UHM lamp (220 W)
Luminosity *1		3 500 lm (PT-LB90NTU/LB90U) 3 000 lm (PT-LB78VU) 2 600 lm (PT-LB75VU)
Scanning frequency *2 (for RGB signal)	Horizontal scanning frequency	15 kHz - 91 kHz
	Vertical scanning frequency	50 Hz - 85 Hz
	Dot clock frequency	Less than 110 MHz
COMPONENT (YP_BPr) signals		525i (480i), 525p (480p), 625i (576i), 625p (576p), 750 (720)/60p, 750 (720)/50p, 1 125 (1 080)/60i, 1 125 (1 080)/50i
Color system		7 (NTSC/NTSC4.43/PAL/PAL-M/PAL-N/PAL60/SECAM)
Projection size		33" - 300" (838.2 mm - 7 620 mm)
Optical axis		5:1 fixed
Throw distance		1.1 m - 11.4 m (3'7" - 37'4")
Screen aspect ratio		4:3
Installation		FRONT/DESK, FRONT/CEILING, REAR/DESK, REAR/CEILING (Menu selection method)
Speaker		1 piece 4 cm × 2 cm (1 5/8" × 3/4")
Max. useable volume output		1.0 W (Monaural)
Terminals	S-VIDEO IN	Single - line, Mini DIN 4p Y: 1.0 V [p-p], C: 0.286 V [p-p], 75 Ω
	VIDEO IN	Single - line, RCA pin jack 1.0 V [p-p], 75 Ω
	COMPUTER	Dual - line, D-Sub HD 15-pin (female) ● RGB input R.G.B.: 0.7 V [p-p], 75 Ω G-SYNC: 1.0 V [p-p], 75 Ω HD, VD/SYNC: TTL high impedance, automatic positive/negative polarity compatible ● YP _B Pr/YC _B Cr input Y: 1.0 V [p-p] (include sync), 75 Ω P _B /C _B , P _R /C _R : 0.7 V [p-p], 75 Ω
	AUDIO IN	Single - line, 0.5 V [rms], RCA pin jack × 2 (L-R)
	COMPUTER AUDIO IN	Single - line, 0.5 V [rms], M3 jack (Stereo MINI)
	VARIABLE AUDIO OUT	Single - line, M3 jack (Stereo MINI) Monitor output/stereo compatible 0 V [rms] - 2.0 V [rms] (variable)
	SERIAL	Single - line, D-Sub 9-pin RS-232C compatible
	LAN (RJ-45)	Single - line, 10Base-T/100Base-TX (PT-LB90NTU only)

*1: Measurement, measuring conditions and method of notation all comply with ISO21118 international standards.

*2: See "List of compatible signals" on page 52 for available signals.

Specifications

Wireless LAN (PT-LB90NTU only)	Compatible	IEEE802.11 b/IEEE802.11 g (Wireless LAN standard protocol)
	Wireless channel	IEEE802.11 b/IEEE802.11 g: 1 - 13 channels
	Distance	Approx. 30 m (98'5") (depends on the usage environment)
Cabinet	Moulded plastic (PC+ABS)	
Dimensions	<ul style="list-style-type: none"> ● Width: 368 mm (14 1/2") ● Height: 88 mm (3 1/2") ● Length: 233 mm (9 1/8") (not including surface projection parts) 	
Weight	Approx. 2.96 kg (6.6 lbs.) *3	
Operating environment	<ul style="list-style-type: none"> ● Temperature: 0 °C - 40 °C (32 °F - 104 °F) When the HIGH ALTITUDE MODE (page 39) is set to ON: 0 °C - 35 °C (32 °F - 95 °F) ● Humidity: 20% - 80% (no condensation) 	
Certifications	UL60950-1 C-UL FCC Class B ICES-003	
Remote control	Power supply	3 V DC (AA battery × 2)
	Operating range	Approx. 15 m (49'2") (when operated directly in front of signal receptor)
	Weight	Approx. 117 g (4.2 ozs.) (including batteries)
	Dimensions	<ul style="list-style-type: none"> ● Width: 48 mm (1 7/8") ● Length: 163 mm (6 3/8") ● Height: 24.5 mm (1") (not including surface projection parts)
Options	Ceiling bracket	ET-PKB80

*3: Average value. Each product has an individual variability in weight.

Ceiling mount bracket safeguards

- Installation work of the ceiling mount bracket should only be carried by a qualified technician.
- Even if it is during guaranteed period, the manufacturer is not responsible for any hazard or damage caused by using a ceiling mount bracket which is not purchased from an authorized distributors, or environmental conditions.
- Remove an unused ceiling mount bracket promptly.
- Make sure to use a torque driver and do not use an electrical screwdriver or an impact screwdriver.

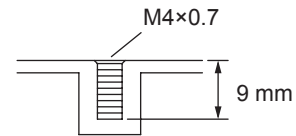
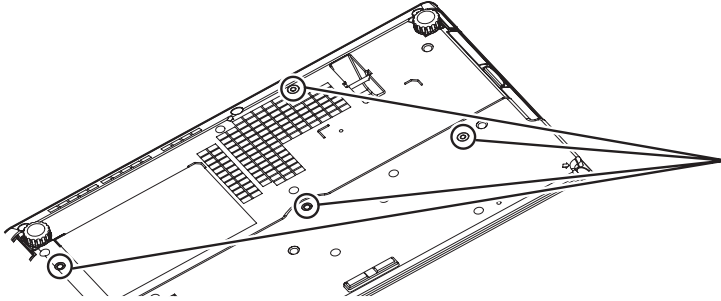

Torque: 1.25 ± 0.2 N·m

Dimensions

Unit: mm

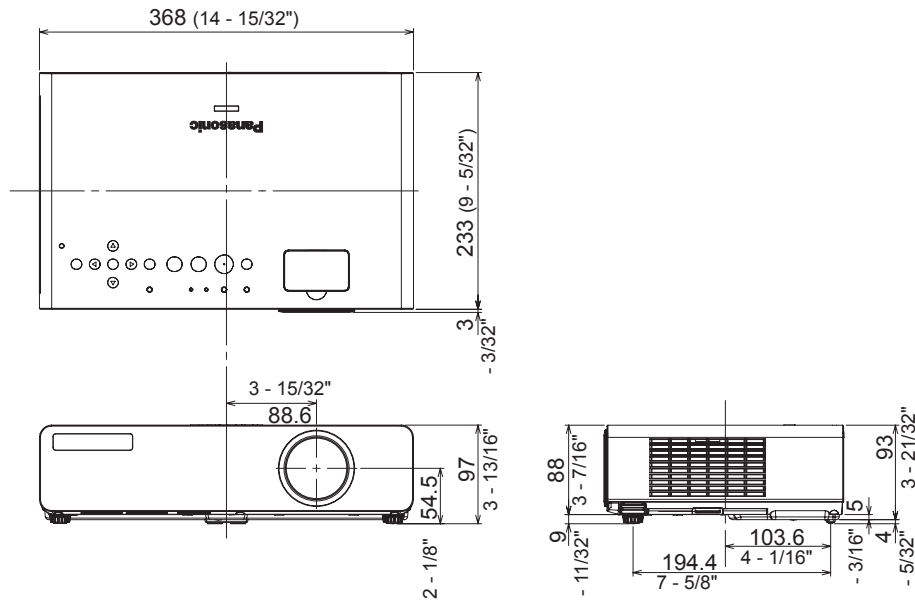

Trademark acknowledgements

- VGA and XGA are trademarks of International Business Machines Corporation.
- S-VGA is a registered trademark of the Video Electronics Standards Association.
- HDMI, the HDMI logo and High-Definition Multimedia Interface are trademarks or registered trademarks of HDMI Licensing LLC.
- The font used in the on-screen displays is a Ricoh bitmap font, which is manufactured and sold by Ricoh Company, Ltd.

All other trademarks are the property of the various trademark owners.

Index

A			
Accessories	10		
ASPECT	33		
AUDIO SETTING.....	41		
AUTO SETUP.....	25, 37		
AV MUTE.....	24		
B			
BACK COLOR	37		
BRIGHTNESS	30		
C			
Cautions on use.....	9		
Cautions when installing.....	8		
Cautions when transporting.....	8		
Cleaning and maintenance.....	9		
Cleaning the projector	47		
CLOCK PHASE	32		
COLOR.....	30		
COLOR TEMPERATURE	30		
Connections.....	17		
Contents	4		
CONTRAST.....	30		
CONTROL DEVICE SETUP.....	44		
D			
DAYLIGHT VIEW.....	31		
DEFAULT.....	25		
Dimensions.....	58		
DISPLAY OPTION menu.....	36		
Disposal.....	9		
DOT CLOCK.....	32		
E			
EMULATE.....	40		
Enlarging the image.....	26		
F			
FRAME LOCK	34		
FREEZE	24		
FUNCTION BUTTON	26, 41		
H			
HIGH ALTITUDE MODE.....	39		
I			
Important Safety Notice	2		
INDEX-WINDOW.....	25		
INITIALIZE ALL.....	42		
INITIAL START UP	39		
INSTALLATION	39		
K			
KEystone.....	32		
L			
LAMP indicator	46		
LAMP POWER	40		
LAMP RUNTIME	40		
LANGUAGE menu.....	35		
LAN terminal.....	54		
List of compatible signals	52		
M			
Main menu.....	28		
MENU LOCK	44		
MENU LOCK PASSWORD	44, 54		
Menu Navigation.....	27		
N			
Navigating through the MENU.....	27		
NETWORK menu	45		
NOISE REDUCTION.....	31		
NO SIGNAL SHUT-OFF	39		
O			
ON-SCREEN DISPLAY	36		
ON-SCREEN MENU	28		
OTHER FUNCTIONS	38		
OVER SCAN	33		
P			
PASSWORD	43		
PASSWORD CHANGE	43		
PICTURE menu.....	30		
PICTURE MODE	30		
Positioning the image	23		
POSITION menu	32		
Power cord	19		
POWER indicator status.....	20		
POWER LOCK indicator status.....	20		
Projection method.....	16		
Projector body	12		
PROJECTOR SETUP menu	39		
R			
Read this first.....	11		
REALTIME KEYSTONE	32		
Remote control	14		
Replacing the Lamp unit.....	48		
RGB/YP _B PR	31		
S			
Screen size and throw distance.....	15		
Security.....	9		
SECURITY menu	43		
Selecting the input signal.....	23		
Serial terminal.....	53		
SHARPNESS	30		
SHIFT	32		
SHIFT V.....	32		
SIGNAL SEARCH	37		
Specifications	55		
STANDBY MODE	40		
STARTUP LOGO.....	37		
STATUS	39		
STILL MODE	31		
Sub-menu	28		
Switching off the projector	22		
Switching on the projector	21		
Switching the input signal	24		
SXGA MODE	38		
T			
TEMP indicator	46		
TEST PATTERN	42		
TEXT CHANGE	43		
TEXT DISPLAY.....	43		
Throwing angle.....	16		
TINT.....	30		
Troubleshooting.....	51		
TV-SYSTEM	31		
V			
VOLUME	25		
W			
WHITE BALANCE	30		
WIDE MODE	38		

Avis important concernant la sécurité

Cher client Panasonic:

Il est important de lire et comprendre les informations suivantes car elles fournissent des détails qui vous permettront d'utiliser le projecteur sans danger pour vous et votre environnement, conformément aux dispositions légales relatives à l'utilisation de projecteurs. Avant de brancher, utiliser ou régler ce projecteur, veuillez lire toute la notice puis la conserver avec le projecteur pour vous y référer ultérieurement. Nous espérons qu'elle vous aidera à optimiser l'utilisation de votre nouveau produit et que vous serez satisfait de votre projecteur LCD Panasonic. Le numéro de série de votre produit se trouve sous le projecteur. Veuillez le noter dans l'espace ci-dessous prévu à cet effet et conserver cette notice en cas de maintenance requise.

Numéro de modèle: PT-LB90NTU/PT-LB90U/PT-LB78VU/PT-LB75VU

Numéro de série:

AVERTISSEMENT: POUR REDUIRE LES RISQUES DE FEU OU DE CHOC ÉLECTRIQUE, NE PAS EXPOSER CE PRODUIT À L'EAU OU À L'HUMIDITÉ.

Alimentation: Ce projecteur LCD est conçu pour fonctionner sur secteur de 100 V - 240 V, 50 Hz/60 Hz seulement.

ATTENTION: Le cordon d'alimentation secteur fourni avec le projecteur peut être utilisé uniquement pour une alimentation électrique de 125 V, 7 A maximum. Si on veut l'utiliser avec une tension ou un courant plus forts, on doit se procurer un autre cordon d'alimentation de 250 V. Si on utilise le cordon fourni sous ces conditions, risque de provoquer un incendie.



Le symbole de la flèche en forme d'éclair, dans un triangle, avertit l'utilisateur de la présence de «tensions dangereuses» à l'intérieur du produit qui peuvent être de force suffisante pour constituer un risque de choc électrique aux personnes.



Le point d'exclamation dans un triangle avertit l'utilisateur de la présence d'instructions importantes concernant l'utilisation et l'entretien (réparation) dans la littérature accompagnant le produit.

ATTENTION: Cet appareil est équipé d'une fiche de courant à trois broches avec mise à la terre. Ne pas retirer la broche de mise à la masse de la fiche. Cette fiche ne pourra être utilisée que dans une prise avec mise à la terre. Ceci est une précaution sécuritaire. S'il est impossible d'insérer la fiche dans la prise, s'adresser à un électricien. Ne pas annuler la protection de la fiche à mise à la terre.

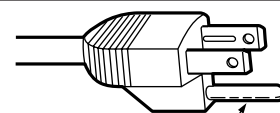

Ne pas retirer

Pursuant to at the directive 2004/108/EC, article 9(2)
Pursuant to at the directive 2005/32/EC amended by 2008/28/EC, article 14
Panasonic Testing Center
Panasonic Service Europe, a division of Panasonic Marketing Europe GmbH
Winsbergring 15, 22525 Hamburg, F.R. Germany

NOTICE:

- Ce produit possède une lampe à décharge haute intensité (DHI) qui contient du mercure. Son élimination peut être réglementée dans votre s à cause de considérations environnementales. Pour d'amples informations sur la mise au rebut ou le recyclage, veuillez contacter vos autorités locales ou aller au site Web de l'Electronics Industries Alliance: <http://www.eiae.org>

Avis important concernant la sécurité

AVERTISSEMENT:

Cet équipement a été soumis à des tests qui ont démontré que celui-ci respectait les limites spécifiées pour les appareils numériques de la classe B aux termes de la partie 15 des règles de la FCC (Federal Communications Commission U.S.A.). Ces limites ont pour objet de fournir une protection raisonnable contre les interférences nuisibles dans le cas d'une installation en milieu résidentiel. Cet équipement produit, utilise et peut rayonner de l'énergie de haute fréquence, et s'il n'est pas installé et utilisé conformément aux instructions fournies avec celui-ci, peut provoquer des interférences nuisibles aux communications radio. En outre, même en cas d'utilisation conforme, il n'est pas garanti qu'aucune interférence ne saurait survenir avec certaines installations. Si cet équipement s'avère nuire à la bonne réception d'émissions de radiophonie ou de télévision, ce que l'on pourra déterminer en mettant l'équipement successivement hors tension puis sous tension, il est conseillé de tenter de remédier au problème par l'une des méthodes suivantes:

- Réorientez ou déplacez l'antenne du récepteur.
- Éloignez l'équipement du récepteur.
- Branchez l'équipement dans une prise de courant située sur un circuit autre que celui qui alimente la prise de courant du récepteur.
- Demandez conseil à votre distributeur ou à un technicien de radio/télévision expérimenté.

ATTENTION: Pour assurer la bonne conformité, utilisez uniquement des câbles d'interface blindés lorsque vous connectez des ordinateurs ou des périphériques. Toute modification non autorisée de cet équipement annulera le droit de l'utilisateur à utiliser cet équipement. Tout changement ou modification non autorisée à cet équipement annule l'autorité de faire fonctionner cet appareil.

Avertissement de la FCC relative à l'exposition RF : (si fourni avec un appareil sans fil)

- Cet équipement est conforme aux limitations concernant l'exposition aux radiations établies par la FCC dans un environnement non contrôlé.
- Cet équipement a été approuvé pour un fonctionnement mobile et requiert de respecter une distance minimum de 20 cm entre l'antenne(s) et toutes les parties de votre corps (sauf les extrémités des mains, poignets et pieds) durant les modes de fonctionnement sans fil.
- Cet équipement ne peut pas être utilisé avec d'autres transmetteurs installés, qui peuvent être capable de transmission simultanée.

AVERTISSEMENT:

- Ne peut être utilisé dans une salle d'ordinateurs telle que définie dans la norme ANSI/NFPA 75 Standard for Protection of Electronic Computer/Data Processing Equipment.
- Pour l'équipement branché en permanence, un dispositif de dis connexion d'accès facile doit être incorporé dans le câble d'installation du bâtiment.
- Pour l'équipement bran chable, une prise secteur d'accès facile doit être installée près de l'équipement

Déclaration de conformité

Modèle n°: PT-LB90NTU/PT-LB90U/PT-LB78VU/PT-LB75VU
Désignation commerciale: **Panasonic**
Fabricant responsable: Panasonic Corporation of North America
Adresse: One Panasonic Way, Secaucus, New Jersey 07094
Téléphone: (888) 411 - 1996
E-mail: projectorsupport@us.panasonic.com

Cet appareil est conforme à la partie 15 des règles de la FCC (Federal Communications Commission U.S.A.) ce qui signifie: (1) que l'appareil ne produit pas d'interférences nuisibles, et (2) que l'appareil est capable de supporter sans danger les interférences reçues, y compris celles susceptibles de perturber son fonctionnement.

Information relative à l'élimination des déchets dans les pays extérieurs à l'Union européenne



Ce pictogramme n'est valide qu'à l'intérieur de l'Union européenne.

Pour connaître la procédure applicable dans les pays hors Union Européenne, veuillez vous renseigner auprès des autorités locales compétentes ou de votre distributeur.



Informations relatives à la protection de l'environnement pour les utilisateurs en Chine



Ce pictogramme n'est valide qu'en Chine.

Précautions de sécurité

AVERTISSEMENT

■ ALIMENTATION

La prise de courant ou le disjoncteur doivent être installés à proximité de l'appareil et doivent être d'accès facile en cas de problèmes. Si les problèmes suivants surviennent, coupez immédiatement l'alimentation électrique.

Si l'on continue d'utiliser le projecteur dans ces conditions, cela peut entraîner un incendie ou des chocs électriques.

- Si des objets étrangers ou de l'eau pénètrent dans le projecteur, couper immédiatement l'alimentation électrique.
- Si le projecteur tombe ou si le cabinet est cassé, couper l'alimentation électrique.
- Si l'on remarque une émission de fumée, d'odeurs suspectes ou de bruits provenant du projecteur, couper l'alimentation électrique.

Veuillez contacter un centre technique agréé pour des réparations et ne pas tenter de réparer le projecteur vous-même.

Pendant un orage, ne pas toucher le projecteur ou le câble.

Il y a risque d'électrocution.

Faire attention à ne pas endommager le cordon d'alimentation.

Si le cordon d'alimentation est endommagé, cela peut entraîner un incendie et des chocs électriques.

- Ne pas endommager le cordon d'alimentation, ne pas le modifier, ne pas le placer sous des objets lourds, ne pas le chauffer, ne pas le placer près d'objets chauffants, ne pas le tordre, ne pas le plier ou le tirer excessivement et ne pas le rouler en boule.

Si le cordon d'alimentation est endommagé, le faire réparer par un centre technique agréé.

Brancher la fiche du cordon d'alimentation fermement dans la prise de courant.

Si la fiche n'est pas complètement insérée, cela peut entraîner des chocs électriques ou la faire surchauffer.

- Ne pas utiliser un câble électrique autre que celui fourni.
- Si la fiche est endommagée ou la plaque de la prise desserrée, celles-ci ne doivent pas être utilisées.

Nettoyer la fiche du cordon d'alimentation régulièrement afin d'éviter toute accumulation de poussière.

Le fait de ne pas respecter ces consignes peut entraîner un incendie.

- Si de la poussière s'accumule sur la fiche du cordon d'alimentation, l'humidité peut endommager l'isolant.
- Si le projecteur n'est pas utilisé pendant une période prolongée, débrancher la fiche du cordon d'alimentation de la prise de courant.

Débrancher la fiche du cordon d'alimentation de la prise de courant et l'essuyer régulièrement avec un tissu sec.

Ne pas manipuler le cordon d'alimentation avec les mains mouillées.

Cela peut entraîner des chocs électriques.

Ne pas surcharger la prise de courant.

Si l'alimentation est surchargée (par exemple, par l'utilisation de trop d'adaptateurs), cela risque de faire surchauffer le projecteur et peut entraîner un incendie.

■ LORS DE L'UTILISATION/INSTALLATION

Ne pas placer de récipient contenant du liquide sur le projecteur.

Si de l'eau se renverse sur le projecteur ou pénètre dans celui-ci, il y aura risque d'incendie ou d'électrocution.

Si de l'eau entre à l'intérieur du projecteur, entrer en contact avec un centre technique agréé.

Ne pas placer le projecteur sur des matériaux comme un tapis ou du tissu éponge.

Cela peut provoquer une surchauffe du projecteur, pouvant entraîner des brûlures, un incendie ou endommager le projecteur.

Ne pas installer le projecteur dans des endroits humides ou poussiéreux ou dans des endroits où le projecteur peut entrer en contact avec des fumées grasses ou de la vapeur.

L'utilisation du projecteur dans de telles conditions peut causer un incendie, des chocs électriques ou une détérioration du boîtier en plastique. Une détérioration du plastique risquerait en effet d'entraîner une chute du projecteur en cas d'installation au plafond.

Ne pas installer ce projecteur dans un endroit qui n'est pas assez résistant pour supporter le poids du projecteur ou sur une surface en pente ou instable.

Cela peut faire tomber le projecteur ou le faire basculer, ce qui peut entraîner des dommages ou des blessures.

Ne pas placer un autre projecteur ou d'autres objets lourds sur le projecteur.

Cela peut déséquilibrer le projecteur et le faire tomber, ce qui peut entraîner des dommages ou des blessures. Le projecteur sera endommagé ou déformé.

Demander à un technicien qualifié d'installer le projecteur par exemple s'il est installé au plafond.

Si l'installation n'est pas faite correctement, cela peut entraîner des blessures ou des accidents, comme des chocs électriques.

- Ne pas utiliser un support de montage au plafond qui n'est pas agréé.

Ne pas obstruer les orifices d'entrée et de sortie d'air.

Cela risque de faire surchauffer le projecteur, et causer un incendie ou endommager le projecteur.

- Ne pas installer le projecteur dans des endroits étroits, mal ventilés tels que des placards ou des étagères.
- Ne pas placer le projecteur sur du tissu ou du papier, ces matériaux peuvent être aspirés dans l'orifice d'entrée d'air.

Ne pas placer les mains ou autres objets près de l'orifice de sortie d'air.

Cela peut entraîner des brûlures ou abîmer vos mains ou d'autres objets.

- De l'air chaud sort par l'orifice de sortie d'air. Ne pas placer les mains ou le visage ou des objets incapables de supporter la chaleur près de l'orifice de sortie d'air.

Veillez à ce que le faisceau lumineux n'éclaire pas directement votre peau pendant que vous utilisez le projecteur.

Cela peut entraîner des brûlures ou une perte de la vue.

- Une lumière intense est émise par l'objectif du projecteur. Si vous vous placez dans ce faisceau lumineux.
- Veiller particulièrement à ce que les enfants ne regardent pas dans l'objectif. En outre, éteindre le projecteur si on le laisse sans surveillance.

Ne pas mettre d'objets étrangers dans le projecteur.

Cela peut entraîner un incendie ou des chocs électriques.

- Ne pas insérer d'objets métalliques ou inflammables dans les orifices de ventilation ou les faire tomber sur le projecteur.

Ne jamais entreprendre toute modification quelconque ou démontage du projecteur.

Des hautes tensions qui peuvent causer de graves blessures sont présentes à l'intérieur du projecteur.

Pour toute inspection, réglage ou réparation, s'adresser à un centre technique agréé.

■ ACCESSOIRES

Ne pas utiliser ou manipuler les piles de manière inappropriée, se référer à ce qui suit.

Sinon, les piles risquent de fuir, de surchauffer, d'exploser ou de prendre feu.

- Utiliser uniquement les piles spécifiées.
- N'utiliser que des piles au manganèse ou alcalines non rechargeables.
- Ne pas démonter des batteries à anode sèche.
- Ne pas chauffer les piles et ne pas les mettre dans de l'eau ou au feu.
- Veiller à ce que les bornes + et – des piles n'entrent pas en contact avec des objets métalliques tels que colliers ou épingles à cheveux.
- Ne pas ranger les piles avec des objets métalliques.
- Ranger les piles dans un sac en plastique, et ne pas les ranger à proximité d'objets métalliques.
- Lorsqu'on insère les piles, veiller à ce que les polarités (+ et –) soient bien respectées.
- Ne pas utiliser une pile neuve avec une ancienne, ni mélanger différents types de piles.
- Ne pas utiliser des piles dont le revêtement externe s'écaille ou est retiré.
- Retirer les piles usées de la télécommande au plus vite.
- Isoler la pile à l'aide d'un ruban ou autre matériau similaire avant de la mettre au rebut.

Ne pas laisser les piles à portée des enfants.

- La pile peut entraîner la mort par suffocation si elle est avalée.
- Si elle est avalée, consulter un médecin immédiatement.

Si le fluide de la pile fuit, ne pas le toucher à mains nues et prendre les mesures suivantes le cas échéant.

- Si du fluide de pile touche votre peau ou un vêtement, cela peut entraîner une inflammation cutanée ou des blessures.
Rincer à l'eau claire et consulter un médecin immédiatement.
- Si du fluide de pile entre en contact avec vos yeux, cela peut entraîner une perte de la vue.
Dans ce cas, ne pas se frotter les yeux. Rincer à l'eau claire et consulter un médecin immédiatement.

Ne pas démonter l'unité de la lampe.

Si la lampe se casse, cela risque d'entraîner des blessures.

Remplacement de la lampe

La lampe a une pression interne élevée. Si elle est manipulée incorrectement, une explosion et de graves blessures ou des accidents peuvent s'ensuivre.

- Le remplacement de la lampe ne doit être effectué que par un technicien qualifié.
- La lampe peut facilement exploser si elle est heurtée contre des objets durs ou si on la laisse tomber.
- Avant de remplacer la lampe, veiller à débrancher la fiche du cordon d'alimentation de la prise de courant. Il y a risque d'électrocution ou d'explosion.
- Lors du remplacement de la lampe, la laisser refroidir pendant au moins une heure avant de la manipuler, sinon il y a des risques de brûlures.

Ne pas laisser des enfants ou des animaux domestiques toucher la télécommande.

- Après avoir utilisé la télécommande, la ranger hors de portée des enfants ou des animaux domestiques.

MISE EN GARDE

■ ALIMENTATION

Pour débrancher le cordon d'alimentation, tenir la fiche et non pas le cordon.

Si le cordon d'alimentation est tiré, le cordon sera endommagé et cela peut causer un incendie, des courts-circuits ou des chocs électriques sérieux.

Si vous n'utilisez pas le projecteur pendant une longue période de temps, débrancher la fiche du cordon d'alimentation de la prise de courant et retirer les piles de la télécommande.

Débrancher la fiche du cordon d'alimentation de la prise de courant avant d'effectuer tout nettoyage.

Sinon cela peut causer des chocs électriques.

■ LORS DE L'UTILISATION/INSTALLATION

Ne pas peser de tout son poids sur ce projecteur.

On risque de tomber ou de casser l'appareil, ce qui peut causer des blessures.

- Veiller tout particulièrement à ce que les enfants ne se tiennent pas debout ou ne s'asseyent pas sur le projecteur.

Ne pas utiliser le projecteur dans des lieux extrêmement chauds.

Cela peut entraîner la détérioration du boîtier externe ou des composants internes ou un incendie.

- Soyez particulièrement vigilant(e) dans des lieux exposés à la lumière solaire directe ou à proximité de fours.

Débrancher toujours tous les câbles avant de déplacer le projecteur.

Le fait de déplacer le projecteur avec des câbles branchés peut endommager les câbles, ce qui pourrait causer un incendie ou des chocs électriques.

■ ACCESSORIES

Ne pas utiliser une lampe usagée.

Cela risque d'entraîner une explosion de la lampe.

Si la lampe s'est cassée, ventiler immédiatement la pièce. Ne pas toucher ni approcher le visage des morceaux cassés.

Le non respect de cette consigne peut entraîner l'absorption du gaz par l'utilisateur. Ce gaz se dégage lorsque la lampe est cassée et il contient presque autant de mercure qu'une lampe fluorescente, de plus les morceaux cassés peuvent provoquer des blessures.

Si vous pensez avoir inhalé du gaz ou que du gaz a pénétré dans votre bouche ou dans vos yeux, contactez un médecin immédiatement.

S'adresser au revendeur pour le remplacement de la lampe et l'inspection de l'intérieur du projecteur.

Ne pas utiliser des projecteurs dont les pieds réglables ou la protection de l'objectif ont été retirés.

Cela peut entraîner un dysfonctionnement des sets ou des accidents.

Précautions lors du transport

Lors du transport du projecteur, ne pas porter le système de réglage des pieds, mais le placer dans sa sacoche. Veuillez ne le porter qu'au niveau de sa base, sans toucher ses autres parties ou surfaces, car cela entraînera des dysfonctionnements.

Lors du transport, placer le projecteur dans la sacoche fournie.

- Orienter l'objectif du projecteur vers le haut et le placer délicatement dans la sacoche de transport.
- Ne placer que le projecteur et les accessoires dans la sacoche de transport, rien d'autre.

Précautions lors de l'installation

Ne pas utiliser le projecteur dans les conditions suivantes.

- **Ne pas utiliser le projecteur en extérieur.**
Ce projecteur a été conçu pour une utilisation en intérieur.
- **Éviter de l'installer dans des endroits sujets à des vibrations ou à des chocs.**
Si le projecteur est installé dans un lieu où des vibrations sont transmises ou s'il est monté dans une voiture ou un bateau, les vibrations ou les impacts endommageront les pièces internes, entraînant une panne. Installer le produit dans un lieu sans vibrations et impacts.
- **Éviter d'installer le projecteur dans des endroits sujets à des changements de température brusques, à proximité d'un climatiseur ou d'un matériel d'éclairage.**
Cela entraînerait des dysfonctionnements ou la durée de vie de la lampe serait raccourcie.
Voir « Indicateur TEMP » à la page 46.
- **Ne pas installer le projecteur près de lignes d'alimentation électrique à haute tension ou de moteurs.**
Le produit sera exposé à des interférences s'il est installé à proximité de lignes d'alimentation électrique haute tension ou de sources d'alimentation.
- **Ne pas installer le projecteur à une altitude supérieure à 2 700 m (8 858 pi).**
Si l'on utilise ce projecteur à une altitude de 1 400 à 2 700 m (4 593 à 8 858 pi), réglez le **MODE HAUTE ALTITUDE** sur **OUI**.
Sinon, cela entraînera des dysfonctionnements ou la durée de vie de la lampe ou d'autres composants sera raccourcie.

Veillez à faire appel à un technicien spécialisé lors de l'installation du projecteur au plafond.

S'il faut installer le produit pour qu'il soit suspendu au plafond, acheter une fixation suspendue en option (modèle n° ET-PKB80). Veuillez appeler un technicien spécialisé ou contacter un centre technique agréé pour l'installation.

Mise au point de l'objectif

Ne pas régler la mise au point de l'objectif dans la période initiale après la mise en service du projecteur. L'objectif du projecteur à clarté élevée est affecté sur le plan thermique par l'éclairage de la source de lumière, ce qui déstabilise la mise au point immédiatement après la mise en route. Veuillez laisser un temps de chauffe d'au moins 30 minutes avant de régler la mise au point de l'objectif.

Précautions lors de l'utilisation

■ Afin d'obtenir la meilleure qualité d'image

Fermer les rideaux ou les volets de toutes les fenêtres et éteindre les lampes fluorescentes situées à proximité de l'écran afin que la lumière extérieure ou la lumière des lampes intérieures n'éclaire pas l'écran. Selon l'emplacement du projecteur, les aérations de sortie d'air ou la chaleur d'un climatiseur peuvent créer un effet chatoyant sur l'écran. Pour cette raison, veiller à ne pas bloquer les aérations de sortie d'air et tenir compte du sens du courant d'air provenant du climatiseur.

■ Ne pas toucher les surfaces de la protection d'objectif avec les mains nues.

Si la surface de l'objectif ou de la protection de l'objectif présente des traces de doigt ou d'autres traces, celles-ci sont agrandies et projetées à l'écran.

■ Ne pas déplacer le projecteur en fonctionnement, ni le soumettre à des vibrations ou des chocs.

La durée de vie de ses composants internes serait raccourcie.

■ Ce projecteur est équipé d'une lampe au mercure sous haute pression, dont les principales caractéristiques sont.

- La luminosité de la lampe diminuera au fil du temps.
- Les chocs et éclats risquent d'endommager ou de réduire la durée de vie de la lampe.
- Dans de rares situations, elle peut exploser rapidement après la première utilisation.
- Les risques d'explosion augmentent si la lampe est utilisée après la date à laquelle elle est supposée être remplacée.
- Si la lampe explose, le gaz qu'elle contient se libère sous forme de fumée.
- La durée de vie d'une lampe à mercure varie selon la lampe spécifique ou les conditions d'utilisation.
- En particulier, le fait de la mettre fréquemment sous tension et hors tension et/ou de manière répétitive ainsi que de l'utiliser pendant 10 heures d'affilée affectera considérablement sa durée de vie. Prévoir une lampe de remplacement.

■ Connexion à un appareil externe

Lors de la connexion du projecteur à un ordinateur ou un appareil externe, utiliser le cordon d'alimentation fourni avec l'appareil en question et un câble d'interface blindé disponible sur le marché.

■ Composants optiques

Il peut être nécessaire de remplacer les composants optiques comme des affichages à cristaux liquides et des plaques polarisantes en moins d'un an si le projecteur est utilisé dans un environnement à haute température ou très poussiéreux, en contact avec des fumées grasses ou de tabac. Pour plus de détails, veuillez contacter votre revendeur.

■ Affichage à cristaux liquides

Les affichages à cristaux liquides sont fabriqués avec précision. Noter quand dans quelques cas rares, des pixels haute précision peuvent manquer ou rester allumés en permanence, mais il ne s'agit pas d'un dysfonctionnement.

Ne pas projeter la même image pendant une longue durée, car elle risquerait de former une après-image sur l'affichage à cristaux liquides. Affichez la mire de l'écran blanc pendant plus d'une heure pour l'effacer. Voir «MIRE DE TEST» à la page 42.

Sécurité

■ Prendre des mesures de sécurité contre les incidents suivants.

- La fuite d'informations personnelles via ce produit.
- L'utilisation non autorisée de ce produit par un tiers malintentionné.
- L'interférence ou l'arrêt de ce produit par un tiers malintentionné.

■ Instructions de sécurité

- Le réseau de connexion doit être sécurisé par un pare-feu ou autre dispositif.
- Modifiez fréquemment votre mot de passe.
- N'utilisez pas un mot de passe facile à deviner.
- Panasonic et ses filiales ne vous demanderont jamais votre mot de passe de façon directe.
- Ne partagez pas votre mot de passe avec des personnes inconnues.
- Définissez un mot de passe et placez des restrictions sur les utilisateurs qui peuvent se connecter.

Nettoyage et entretien

■ Demander à un centre technique agréé de nettoyer l'intérieur du projecteur au moins une fois par an.

S'il n'est pas nettoyé et que de la poussière s'accumule à l'intérieur du projecteur, cela peut causer un incendie ou des problèmes de fonctionnement. Il est recommandé de nettoyer l'intérieur du projecteur avant l'arrivée de la saison humide.

Demander au centre technique agréé le plus proche de nettoyer le projecteur lorsque cela est requis.

Se renseigner auprès du centre technique agréé pour le coût du nettoyage.

Mise au rebut

Pour connaître la procédure applicable, veuillez vous renseigner auprès des autorités locales compétentes ou de votre distributeur.

Remplacement de l'unité de la lampe

■ Filtre à air

Le filtre à air doit être remplacé lorsque le nettoyage ne donne pas de bons résultats ou lors du remplacement de l'unité de lampe. Un filtre à air ainsi qu'une lampe de rechange sont fournis (ET-LAB80). S'adresser à un centre technique agréé pour commander le filtre à air en option (TXFMZ01VKG7).

■ L'unité de lampe

L'unité de lampe ET-LAB80 a une certaine durée de vie et vous devez la remplacer régulièrement. Il est recommandé de faire remplacer l'unité de lampe par un technicien qualifié et de contacter un centre technique agréé.

■ Remarque sur le remplacement de l'unité de la lampe

- Manipuler l'unité de la lampe avec prudence car elle contient du verre. Si elle tombe ou qu'elle reçoit un choc, elle pourrait s'endommager ou éclater.
- Si vous souhaitez jeter la lampe usagée, veuillez vous renseigner auprès des autorités locales compétentes ou de votre distributeur pour connaître la bonne méthode.
- Préparer un tournevis cruciforme.
- Lors du remplacement de l'unité de la lampe, veillez à la tenir par la poignée.
- Tenez l'unité de la lampe horizontalement pour éviter que les pièces cassées ne se répandent. En cas d'installation du projecteur au plafond, ne jamais travailler directement dessous et éloigner le visage du projecteur, sortir la lampe horizontalement.

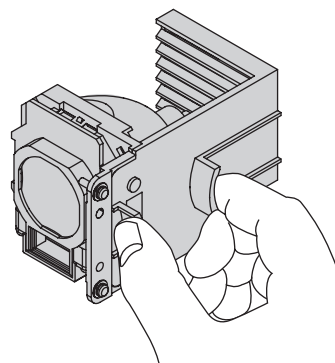

Remarque



- Avant de remplacer la lampe, la laisser refroidir pour éviter les risques de brûlures, les dommages et autres dangers.

Remarques

- Ne pas essayer de la remplacer par une lampe non recommandée.

■ Quand changer l'unité de la lampe

Lorsque la lampe est usée, la luminosité risque de diminuer. Le remplacement de l'unité de lampe doit se faire environ toutes les 3 000 heures d'utilisation, Cette durée peut être plus courte selon les conditions d'utilisation, les caractéristiques de l'unité de lampe ou les conditions environnementales. Pour connaître la durée d'utilisation, vérifier le paramètre **DURÉE DE LA LAMPE** du menu **RÉGLAGE PROJECTEUR**. N'utilisez pas de lampe plus de 3 000 heures. Sinon la lampe pourrait exploser.

	MENU À L'ÉCRAN	Indicateur LAMPE
		
2 800 heures	Affiche " REEMPLACER LA LAMPE " dans la partie supérieure gauche de l'écran pendant 30 secondes. Si vous appuyez sur une touche sous 30 secondes, le message disparaît.	S'allume en rouge, même en mode standby.
3 000 heures	Affiche " REEMPLACER LA LAMPE " dans la partie supérieure gauche jusqu'à ce que appuyiez sur une touche. L'alimentation est automatiquement coupée dans 10 minutes.	

Remarques

- La durée indiquée de 3 000 heures est une estimation basée sur certaines conditions et ne représente en aucun cas une durée garantie.

■ Procédure de remplacement de la lampe

- En cas d'installation du projecteur au plafond, ne jamais travailler directement dessous et éloigner le visage du projecteur.
- S'assurer d'installer l'unité de la lampe et de fixer la protection de l'unité fermement. Si elles ne sont pas installées fermement, le circuit de protection peut s'enclencher et bloquer la mise sous tension de l'appareil.

- 1) Débranchez la prise de courant de la prise selon les descriptions de la section « Arrêt du projecteur » (➔page 22), attendez au moins 1 heure et vérifiez ensuite si la base de l'unité de la lampe est refroidie.
- 2) Dévisser à l'aide d'un tournevis cruciforme les 2 vis de fixation du couvercle de la lampe à l'arrière du projecteur jusqu'à ce qu'elles tournent librement, puis retirer le couvercle de la lampe.

Vis de fixation du couvercle de l'unité de la lampe

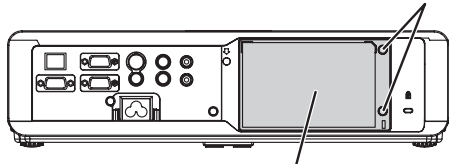

Couvercle de la l'unité de la lampe

- 3) Resserrer les 3 vis de fixation de l'unité de la lampe à l'aide du tournevis cruciforme. Tenir l'unité de la lampe par la poignée puis débloquer le verrou de la lampe.

Vis de fixation de l'unité de la lampe

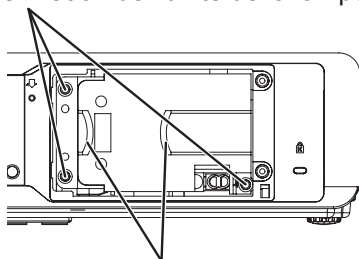

Poignées

- 4) Appuyer sur l'unité de la lampe jusqu'à ce qu'elle s'encliquète et s'assurer qu'elle soit bien fixée en place. Resserrer les 3 vis de fixation de l'unité de la lampe à l'aide du tournevis cruciforme. Lors de l'insertion, appuyez fermement sur la portion (A).

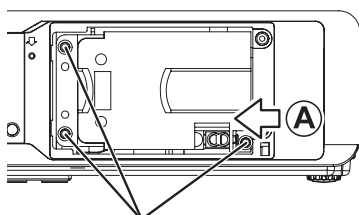

Vis de fixation du couvercle de l'unité de la lampe

- 5) Remettre en place le couvercle de la lampe puis resserrer les 2 vis de fixation du couvercle de la lampe à l'aide du tournevis cruciforme.
- 6) Brancher le cordon d'alimentation à une prise.
- 7) Appuyez sur la touche ALIMENTATION pour démarrer la projection.

Remarques

- Si le paramètre DÉMARRAGE INITIAL dans le menu RÉGLAGE PROJECTEUR est réglé sur OUI, la projection commence même si le cordon d'alimentation est connecté à une prise secteur. (➔page 39)
- 8) Appuyez sur la touche MENU pour afficher le menu principal et appuyez sur les touches ▲▼ pour accéder au menu RÉGLAGE PROJECTEUR.
 - 9) Appuyez sur la touche VALIDER pour sélectionner le menu RÉGLAGE PROJECTEUR et appuyez sur les touches ▲▼ pour sélectionner DURÉE DE LA LAMPE.
 - 10) Maintenir enfoncée la touche VALIDER pendant environ 3 secondes.
 - L'écran de confirmation DURÉE DE LA LAMPE s'affiche.



Remarque

- Si vous appuyez sur une autre touche que la touche ALIMENTATION, l'écran DURÉE DE LA LAMPE disparaît et la durée de la lampe n'est pas réinitialisée. (Répéter à partir de l'étape 8).
- 11) Appuyer sur la touche ALIMENTATION.
 - Une fois que la lampe est éteinte, la projection s'arrête et la touche ALIMENTATION s'allume en rouge. Déconnectez la prise du cordon d'alimentation.
 - 12) La durée de la lampe est redéfinie sur « 0 ».

NOTE:

This product contains a CR Coin Cell Lithium Battery which contains Perchlorate Material - special handling may apply.

See www.dtsc.ca.gov/hazardouswaste/perchlorate.

Panasonic Corporation

Web Site : <http://panasonic.net/avc/projector/>

© Panasonic Corporation 2009

Panasonic Broadcast & Television Systems Company

Unit of Panasonic Corporation of North America

One Panasonic Way, Secaucus, NJ 07094

TEL: (201) 348 - 7000

Technical Support:

TEL: (888) 411 - 1996

FAX: (201) 348 - 7523

E-Mail: projectorsupport@us.panasonic.com

Panasonic Canada Inc.

5770 Ambler Drive, Mississauga, Ontario L4W 2T3

TEL: (905) 624 - 5010

F1009-1109B

TQBJ0302