

## Operating Instructions Functional Manual

LCD Projector **Commercial Use**

Model No. **PT-MZ670**  
**PT-MW630**  
**PT-MZ570**  
**PT-MW530**

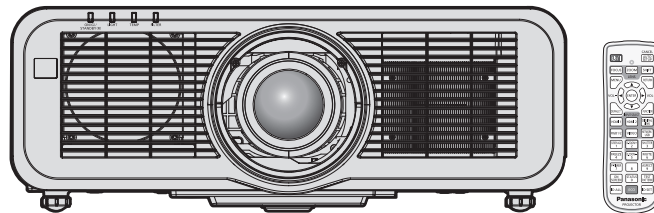

Thank you for purchasing this Panasonic product.

- This manual is common to all the models regardless of suffixes of the Model No.
  - for India
    - D: The standard zoom lens supplied
  - for Asia (except for Taiwan, Korea) / Oceania
    - A: The standard zoom lens supplied      LA: The lens sold separately
  - for Taiwan
    - A: The standard zoom lens supplied
  - for Korea
    - Without L: The standard zoom lens supplied
    - With L: The lens sold separately (PT-MZ670L, PT-MZ570L only)
  - for other countries or regions
    - Without L: The standard zoom lens supplied      With L: The lens sold separately
- Before operating this product, please read the instructions carefully and save this manual for future use.
- Before using this product, be sure to read “Read this first!” (➡ pages 5 to 15).



# Contents

## Read this first! ..... 5

### Chapter 1 Preparation

<b>Precautions for use</b> .....	<b>19</b>
Lens protection material .....	19
Cautions when transporting .....	19
Cautions when installing .....	19
Security .....	22
Notes regarding the wireless LAN .....	22
Light ID .....	23
DIGITAL LINK .....	24
Application software supported by the projector .....	24
Disposal .....	24
Storing .....	24
Cautions on use .....	25
Accessories .....	26
Optional accessories .....	27
<b>About your projector</b> .....	<b>28</b>
Remote control .....	28
Projector body .....	30
<b>Preparing the remote control</b> .....	<b>33</b>
Inserting and removing the batteries .....	33
When using the multiple projectors .....	33
Connecting the remote control to the projector with a cable .....	33

### Chapter 2 Getting Started

<b>Setting up</b> .....	<b>35</b>
Installation mode .....	35
Parts for installation (optional) .....	36
Projected image and throw distance .....	37
Adjusting adjustable feet .....	47
<b>Removing/attaching the projection lens</b> .....	<b>48</b>
Removing the projection lens .....	48
Attaching the projection lens .....	49
<b>Attaching the Wireless Module</b> .....	<b>50</b>
Attaching the Wireless Module .....	50
<b>Connecting</b> .....	<b>51</b>
Before connecting .....	51
Connecting example: AV equipment .....	52
Connecting example: Computers .....	53
Connecting example using DIGITAL LINK .....	54

### Chapter 3 Basic Operations

<b>Switching on/off the projector</b> .....	<b>57</b>
Connecting the power cord .....	57
Power indicator .....	58
Switching on the projector .....	59
When the initial setting screen is displayed .....	60
Making adjustments and selections .....	64
Switching off the projector .....	65
<b>Projecting</b> .....	<b>66</b>
Selecting the input signal .....	66
Adjusting the focus, zoom, and lens shift .....	67
Moving the lens position to the home position .....	68
Adjustment range by the lens position shift (optical shift) .....	68
<b>Using the USB memory</b> .....	<b>69</b>
Notes on use .....	69
USB memory that can be used with the projector .....	69
Attaching the USB memory .....	69
Removing the USB memory .....	70
<b>Operating with the remote control</b> .....	<b>71</b>
Using the shutter function .....	71
Using the mute function .....	71
Adjusting the volume .....	72
Using the freeze function .....	72
Using the on-screen display function .....	72
Using the automatic setup function .....	73
Using the screen adjustment function .....	73
Using the digital zoom function .....	74
Switching the image aspect ratio .....	75
Using the presentation timer function .....	75
Using the function button .....	75
Displaying internal test pattern .....	75
Using the status function .....	76
Using the ECO management function .....	76
Setting ID number of the remote control .....	76

### Chapter 4 Settings

<b>Menu navigation</b> .....	<b>79</b>
Navigating through the menu .....	79
Main menu .....	80
Sub-menu .....	81

## Contents

<b>[PICTURE] menu</b> .....	<b>84</b>	<b>[PROJECTOR SETUP] menu</b> .....	<b>112</b>
[PICTURE MODE].....	84	[PROJECTOR ID].....	112
[CONTRAST].....	84	[PROJECTION METHOD].....	112
[BRIGHTNESS].....	84	[ECO MANAGEMENT].....	113
[COLOR].....	85	[LightID].....	115
[TINT].....	85	[INITIAL STARTUP].....	116
[COLOR TEMPERATURE].....	85	[STARTUP INPUT SELECT].....	116
[GAMMA].....	86	[DATE AND TIME].....	117
[DAYLIGHT VIEW].....	87	[SCHEDULE].....	118
[SHARPNESS].....	87	[RS-232C].....	119
[NOISE REDUCTION].....	87	[REMOTE1 MODE].....	121
[DYNAMIC CONTRAST].....	88	[FUNCTION BUTTON].....	121
[SYSTEM SELECTOR].....	88	[LENS CALIBRATION].....	121
<b>[POSITION] menu</b> .....	<b>89</b>	[AUDIO SETTING].....	122
[SHIFT].....	89	[FILTER COUNTER].....	124
[ASPECT].....	89	[DC OUT].....	125
[ZOOM].....	90	[STATUS].....	125
[CLOCK PHASE].....	91	[DATA CLONING].....	126
[REALTIME KEYSTONE].....	91	[SAVE ALL USER DATA].....	129
[SCREEN ADJUSTMENT].....	92	[LOAD ALL USER DATA].....	129
<b>[ADVANCED MENU] menu</b> .....	<b>95</b>	[INITIALIZE].....	129
[DIGITAL CINEMA REALITY].....	95	[SERVICE PASSWORD].....	130
[BLANKING].....	95	<b>[TEST PATTERN] menu</b> .....	<b>131</b>
[INPUT RESOLUTION].....	96	[TEST PATTERN].....	131
[CLAMP POSITION].....	96	<b>[SIGNAL LIST] menu</b> .....	<b>132</b>
[RASTER POSITION].....	97	Registering new signals.....	132
<b>[DISPLAY LANGUAGE] menu</b> .....	<b>98</b>	Renaming the registered signal.....	132
Changing the display language.....	98	Deleting the registered signal.....	132
<b>[DISPLAY OPTION] menu</b> .....	<b>99</b>	Protecting the registered signal.....	133
[COLOR ADJUSTMENT].....	99	Expanding signal lock-in range.....	133
[COLOR CORRECTION].....	99	Sub memory.....	134
[SCREEN SETTING].....	100	<b>[SECURITY] menu</b> .....	<b>135</b>
[AUTO SIGNAL].....	100	[SECURITY PASSWORD].....	135
[AUTO SETUP].....	100	[SECURITY PASSWORD CHANGE].....	135
[RGB IN].....	101	[DISPLAY SETTING].....	135
[HDMI IN].....	102	[TEXT CHANGE].....	136
[DIGITAL LINK IN].....	103	[MENU LOCK].....	136
[ON-SCREEN DISPLAY].....	104	[MENU LOCK PASSWORD].....	136
[CLOSED CAPTION SETTING] (only when NTSC signal is input).....	107	[CONTROL DEVICE SETUP].....	137
[SIGNAL SEARCH].....	107	[CONTROL DEVICE PASSWORD CHANGE] .....	138
[BACK COLOR].....	108		
[STARTUP LOGO].....	108		
[SHUTTER SETTING].....	108		
[P-TIMER].....	109		
[FREEZE].....	110		
[DIGITAL ZOOM].....	110		

## Contents

<b>[NETWORK/USB] menu</b> .....	<b>139</b>	<b>Maintenance/replacement</b> .....	<b>198</b>
[DIGITAL LINK MODE].....	139	Before performing maintenance/replacement.....	198
[DIGITAL LINK STATUS].....	139	Maintenance.....	198
[DIGITAL LINK MENU].....	140	Replacing the unit.....	200
[WIRED LAN].....	140	<b>Troubleshooting</b> .....	<b>202</b>
[WIRELESS LAN].....	141	<b>FAQ</b> .....	<b>204</b>
[PROJECTOR NAME].....	145	Wireless LAN connection.....	204
[NETWORK CONTROL].....	145	Mirroring connection.....	204
[MEMORY VIEWER].....	145	<b>[SELF TEST] display</b> .....	<b>206</b>
[Panasonic APPLICATION].....	147		
[MIRRORING].....	149		
[NETWORK STATUS].....	150		
<b>Chapter 5 Operations</b>			
<b>Network connection</b> .....	<b>153</b>		
Connecting via wired LAN.....	154		
Connecting with the wireless LAN.....	156		
<b>Web control function</b> .....	<b>158</b>		
Computer that can be used for setting.....	158		
Accessing from the web browser.....	158		
<b>Projecting with Panasonic APPLICATION input</b> .....	<b>178</b>		
Application that can be used.....	178		
Connecting the device.....	178		
Ending the connection with the device.....	178		
Description of the standby screen.....	179		
Using the moderator mode in the Panasonic APPLICATION input.....	180		
<b>Projecting with MIRRORING input</b> .....	<b>181</b>		
Connecting the device.....	181		
Ending the connection with the device.....	182		
Using the moderator mode in the MIRRORING input.....	182		
Operating with the web browser.....	183		
Description of the [MODERATOR MODE] page .....	184		
<b>Projecting with MEMORY VIEWER input</b> .....	<b>185</b>		
Images that can be played back with the Memory Viewer function.....	185		
Displaying the Memory Viewer screen.....	186		
Operating the Memory Viewer screen.....	186		
Playing back still images.....	188		
Playing back movies.....	189		
Description of the Memory Viewer screen.....	191		
Playing back using the contents list.....	192		
<b>Using the pairing function</b> .....	<b>193</b>		
Pairing the USB memory.....	193		
<b>Chapter 6 Maintenance</b>			
<b>Light source/temperature/filter indicators</b> .....	<b>196</b>		
When an indicator lights up.....	196		

# Read this first!

**WARNING:** THIS APPARATUS MUST BE EARTHED.

**WARNING:** To prevent damage which may result in fire or shock hazard, do not expose this appliance to rain or moisture.  
This device is not intended for use in the direct field of view at visual display workplaces. To avoid incommoding reflexions at visual display workplaces this device must not be placed in the direct field of view.  
The equipment is not intended for used at a video workstation in compliance BildscharbV.

The sound pressure level at the operator position is equal or less than 70 dB (A) according to ISO 7779.

**WARNING:**

1. Remove the plug from the mains socket when this unit is not in use for a prolonged period of time.
2. To prevent electric shock, do not remove cover. No user serviceable parts inside. Refer servicing to qualified service personnel.
3. Do not remove the earthing pin on the mains plug. This apparatus is equipped with a three prong earthing-type mains plug. This plug will only fit an earthing-type mains socket. This is a safety feature. If you are unable to insert the plug into the mains socket, contact an electrician. Do not defeat the purpose of the earthing plug.

**WARNING:**

This equipment is compliant with Class A of CISPR32.  
In a residential environment this equipment may cause radio interference.

## (for Taiwan)

**WARNING:**

This equipment complies with the Class A standard of CISPR32.  
This is Class A information technology equipment that may cause radio frequency interference when used in a residential environment, in which the user will be required to take certain appropriate countermeasures.

**CAUTION:** To assure continued compliance, follow the attached installation instructions. This includes using the provided power cord and shielded interface cables when connecting to computer or peripheral devices. Also, any unauthorized changes or modifications to this equipment could void the user's authority to operate this device.

This is a device to project images onto a screen, etc., and is not intended for use as indoor lighting in a domestic environment.

Directive 2009/125/EC

**WARNING:** TO REDUCE THE RISK OF FIRE OR ELECTRIC SHOCK, DO NOT EXPOSE THIS PRODUCT TO RAIN OR MOISTURE.

**WARNING:** RISK OF ELECTRIC SHOCK. DON'T OPEN



Indicated on the projector



The lightning flash with arrowhead symbol, within an equilateral triangle, is intended to alert the user to the presence of uninsulated "dangerous voltage" within the product's enclosure that may be of sufficient magnitude to constitute a risk of electric shock to persons.



The exclamation point within an equilateral triangle is intended to alert the user to the presence of important operating and maintenance (servicing) instructions in the literature accompanying the product.

**Read this first!**

**WARNING:** Do not look at the light emitted from the lens while the projector is being used. As with any bright source, do not stare into the direct beam.



RG2

Indicated on the projector

RG2 IEC 62471-5:2015

**Notice on laser  
(for USA and Canada)**

This projector is the Class 3R laser product that complies with IEC 60825-1:2007.



For North America  
**LASER APERTURE**  
**OUVERTURE LASER**  
TOFX641

DPQT1282ZA

130C  
For North America  
Complies with 21 CFR Parts 1040.10 and 1040.11  
except for deviations pursuant to Laser Notice  
No.50 dated June 24,2007

IEC 60825-1:2007  
LASER RADIATION  
AVOID DIRECT EYE EXPOSURE  
CLASS 3R LASER PRODUCT  
WAVE LENGTH:452-458nm  
MAXIMUM OUTPUT:333mW

IEC 60825-1:2007  
RAYONNEMENT LASER  
EXPOSITION DIRECTE DANGEREUSE POUR LES YEUX  
APPAREIL LASER DE CLASSE 3R  
LONGUEURS D'ONDES:452-458nm  
MAXIMALE DU RAYONNEMENT:333mW

危険-開放時クラス4のレーザー放射  
直接放射又は分散放射に眼又は皮膚を暴露させないこと  
DANGER-CLASS 4 LASER RADIATION WHEN OPEN AVOID EYE OR  
SKIN EXPOSURE TO DIRECT OR SCATTERED RADIATION  
DANGER-RAYONNEMENT LASER DE CLASSE 4 - EN CAS D'OUVERTURE  
EXPOSITION DANGEREUSE AU RAYONNEMENT DIRECT OU  
DIFFUS DES YEUX OU DE LA PEAU  
DPQT1025ZA

(Inside of product)

注意-開放時クラス2のレーザー放射  
直接放射又は分散放射に眼又は皮膚を暴露させないこと  
CAUTION-CLASS 2 LASER RADIATION WHEN OPEN AVOID EYE OR  
SKIN EXPOSURE TO DIRECT OR SCATTERED RADIATION  
CAUTION-RAYONNEMENT LASER DE CLASSE 2 - EN CAS D'OUVERTURE  
EXPOSITION DANGEREUSE AU RAYONNEMENT DIRECT OU  
DIFFUS DES YEUX OU DE LA PEAU  
DPQT1303ZA

Indicated on the projector

**(for India)**

This projector is the Class 1 laser product that complies with IEC/EN 60825-1:2014.

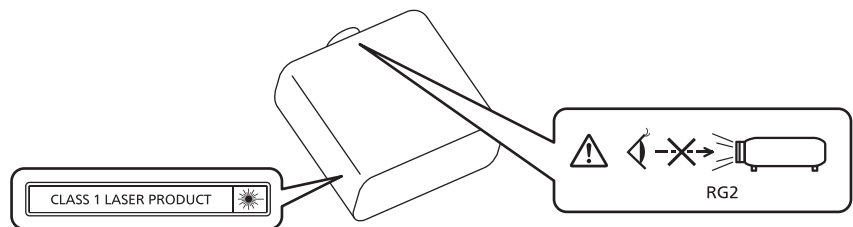

CLASS 1 LASER PRODUCT

**Read this first!**

**(for other countries or regions)**

This projector is the Class 1 laser product that complies with IEC/EN 60825-1:2014.

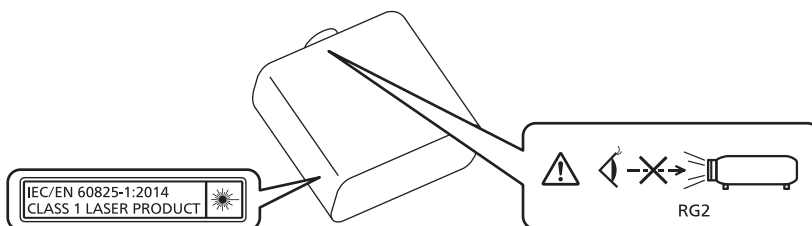

**CAUTION:** Use of controls or adjustments or performance of procedures other than those specified herein may result in hazardous radiation exposure.

**CAUTION (North/Middle/South America/Taiwan)**

**Power Supply:** This Projector is designed to operate on 100 V - 240 V, 50 Hz/60 Hz AC, house current only.

**CAUTION:** The AC power cord which is supplied with the projector as an accessory can only be used for power supplies up to 125 V. If you need to use higher voltages than this, you will need to obtain a separate 250 V power cord. If you use the accessory cord in such situations, fire may result.

**CAUTION (North/Middle/South America/Taiwan)**

This equipment is equipped with a three-pin grounding-type power plug. Do not remove the grounding pin on the power plug. This plug will only fit a grounding-type power outlet. This is a safety feature. If you are unable to insert the plug into the outlet, contact an electrician. Do not defeat the purpose of the grounding plug.

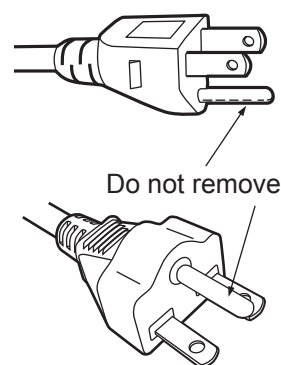

**WARNING (USA and Canada)**

- Not for use in a computer room as defined in the Standard for the Protection of Electronic Computer/Data Processing Equipment, ANSI/NFPA 75.
- For permanently connected equipment, a readily accessible disconnect device shall be incorporated in the building installation wiring.
- For pluggable equipment, the socket-outlet shall be installed near the equipment and shall be easily accessible.

**NOTIFICATION (Canada)**

This class A digital apparatus complies with Canadian ICES-003.

**For USA-California Only**

This product contains a CR Coin Cell Lithium Battery which contains Perchlorate Material – special handling may apply.  
See [www.dtsc.ca.gov/hazardouswaste/perchlorate](http://www.dtsc.ca.gov/hazardouswaste/perchlorate)

## FCC NOTICE (USA)

### Verification

Model Number: PT-MZ670 / PT-MZ670L / PT-MW630 / PT-MW630L /  
PT-MZ570 / PT-MZ570L / PT-MW530 / PT-MW530L  
Trade Name: Panasonic  
Responsible Party: Panasonic Corporation of North America  
Address: Two Riverfront Plaza, Newark, NJ 07102-5490  
General Contact: <http://www.panasonic.com/support>  
Projector Contact: <https://panasonic.net/cns/projector/>

This device complies with Part 15 of the FCC Rules.

Operation is subject to the following two conditions:

(1) This device may not cause harmful interference, and (2) this device must accept any interference received, including interference that may cause undesired operation.

### Caution:

This equipment has been tested and found to comply with the limits for a Class A digital device, pursuant to part 15 of the FCC Rules. These limits are designed to provide reasonable protection against harmful interference when the equipment is operated in a commercial environment. This equipment generates, uses, and can radiate radio frequency energy and, if not installed and used in accordance with the instruction manual, may cause harmful interference to radio communications. Operation of this equipment in a residential area is likely to cause harmful interference in which case the user will be required to correct the interference at his own expense.

### FCC Warning:

To assure continued compliance, follow the attached installation instructions. This includes using the provided power cord and shielded interface cables when connecting to computer or peripheral devices. Also, any unauthorized changes or modifications to this equipment could void the user's authority to operate this device.



## IMPORTANT: THE MOLDED PLUG

FOR YOUR SAFETY, PLEASE READ THE FOLLOWING TEXT CAREFULLY.

This appliance is supplied with a molded three pin mains plug for your safety and convenience. A 13 amp fuse is fitted in this plug. Should the fuse need to be replaced, please ensure that the replacement fuse has a rating of 13 amps and that it is approved by ASTA or BSI to BS1362.

Check for the ASTA mark  or the BSI mark  on the body of the fuse.

If the plug contains a removable fuse cover, you must ensure that it is refitted when the fuse is replaced. If you lose the fuse cover, the plug must not be used until a replacement cover is obtained. A replacement fuse cover can be purchased from an Authorized Service Center.

**If the fitted molded plug is unsuitable for the mains socket in your home, then the fuse should be removed and the plug cut off and disposed of safely. There is a danger of severe electrical shock if the cut off plug is inserted into any 13 amp socket.**

If a new plug is to be fitted, please observe the wiring code as shown below.  
If in any doubt, please consult a qualified electrician.

**WARNING:** THIS APPLIANCE MUST BE EARTHED.

**IMPORTANT:** The wires in this mains lead are colored in accordance with the following code:

Green - and - Yellow: Earth  
Blue: Neutral  
Brown: Live

As the colors of the wire in the mains lead of this appliance may not correspond with the colored markings identifying the terminals in your plug, proceed as follows.

The wire which is colored GREEN - AND - YELLOW must be connected to the terminal in the plug which is marked with the letter E or by the Earth symbol  $\perp$  or colored GREEN or GREEN - AND - YELLOW.

The wire which is colored BLUE must be connected to the terminal in the plug which is marked with the letter N or colored BLACK.

The wire which is colored BROWN must be connected to the terminal in the plug which is marked with the letter L or colored RED.

How to replace the fuse: Open the fuse compartment with a screwdriver and replace the fuse.

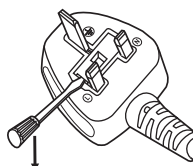

**Importer's name and address within the European Union**

**Panasonic Marketing Europe GmbH**

**Panasonic Testing Centre**

**Winsbergring 15, 22525 Hamburg, Germany**

### Hazard distance (IEC 62471-5)

The distance at which the level of exposure has dropped to the level of the applicable Exposure Limit Value is known as the hazard distance or safety distance.

Do not look or stare into the light beam from a distance closer than the hazard distance (RG3 = risk group 3). Beyond this distance the light beam is considered to be safe. (RG2 = risk group 2)

RG3 level is considered to be a hazard to the eyes from direct radiation.

RG2 level does not pose any optical hazard and can be safely used in all situations.

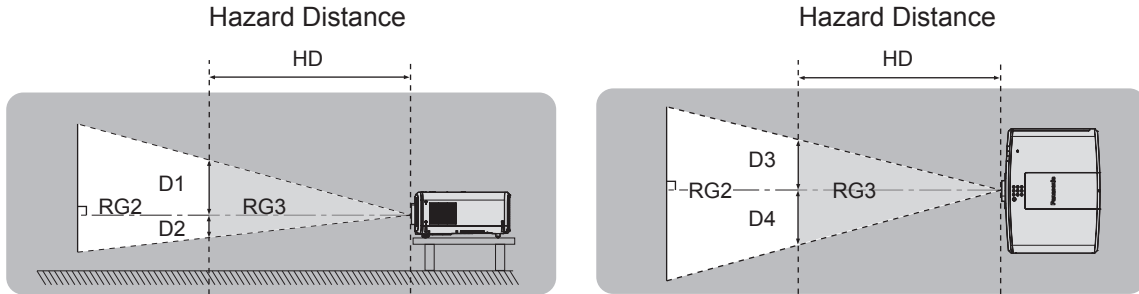

(Unit: m)

Lens	HD*1	D1*2 max.	D2*2 max.	D3*2 max.	D4*2 max.
ET-ELW21	< 1.0	0.97	0.97	1.13	1.13
ET-ELW22	< 1.0	0.89	0.89	1.03	1.03
ET-ELW20	< 1.0	0.62	0.62	0.72	0.72
Standard Zoom Lens/ ET-ELS20	< 1.0	0.47	0.47	0.55	0.55
ET-ELT20	< 1.0	0.29	0.29	0.34	0.34
ET-ELT21	1.9	0.34	0.34	0.39	0.39

\*1 Hazard Distance

\*2 D1, D2, D3, and D4 change in accordance with projection lens shift amount. Each number in this table is worst case.

#### Note

- Each table complies with IEC 60825-1 (2014) and IEC 62471-5 (2015)

THIS PROJECTOR MAY BECOME RG3 FOR PROFESSIONAL USE ONLY AND ARE NOT INTENDED FOR CONSUMER USE WITH INTERCHANGEABLE PROJECTION LENS ET-ELT21. REFER TO THE OPERATING INSTRUCTIONS FOR HAZARD DISTANCE BEFORE OPERATION.

CE PROJECTEUR PEUT DEVENIR RG3 POUR UNE UTILISATION PROFESSIONNELLE UNIQUEMENT ET N'EST PAS DESTINÉ À UNE UTILISATION DOMESTIQUE AVEC L'OBJECTIF DE PROJECTION INTERCHANGEABLE ET-ELT21. CONSULTEZ LE MANUEL D'UTILISATION ET PRENEZ CONNAISSANCE DE LA DISTANCE DU RISQUE AVANT DE L'UTILISER.

DIESER PROJEKTOR KANN AUSSCHLIESSLICH FÜR DIE PROFESSIONELLE VERWENDUNG ALS RG3 EINGESTUFT WERDEN UND IST MIT DEM AUSTAUSCHPROJEKTIONSOBJEKTIV ET-ELT21 NICHT FÜR DIE VERWENDUNG DURCH VERBRAUCHER KONZIPIERT. BEACHTEN SIE VOR DER BEDIENUNG DIE BEDIENUNGSANLEITUNG IN BEZUG AUF DEN GEFÄHRDUNGSABSTAND.

ДАННЫЙ ПРОЕКТОР МОЖЕТ ВХОДИТЬ В ГРУППУ РИСКА RG3 – ТОЛЬКО ДЛЯ ПРОФЕССИОНАЛЬНОГО ИСПОЛЬЗОВАНИЯ, И ОН НЕ ПРЕДНАЗНАЧЕН ДЛЯ ИСПОЛЬЗОВАНИЯ ПОТРЕБИТЕЛЯМИ СО СМЕННЫМ ПРОЕКЦИОННЫМ ОБЪЕКТИВОМ ET-ELT21. ПЕРЕД НАЧАЛОМ РАБОТЫ ОБРАТИТЕСЬ К ИНСТРУКЦИЯМ ПО ЭКСПЛУАТАЦИИ, ЧТОБЫ УЗНАТЬ ПРО ОПАСНОЕ РАССТОЯНИЕ.

이 프로젝터는 투사 렌즈 ET-ELT21과 함께 사용하는 경우, 전문가 전용인 RG3 등급으로 되며, 일반 소비자용이 아닙니다. 작동하기 전에 위험 거리에 대해서는 사용 설명서를 참조하십시오.  
DPQT1307ZA

## **WARNING:**

### **■ POWER**

**The wall outlet or the circuit breaker shall be installed near the equipment and shall be easily accessible when problems occur. If the following problems occur, cut off the power supply immediately.**

Continued use of the projector in these conditions will result in fire or electric shock, or will cause visual impairment.

- If foreign objects or water get inside the projector, cut off the power supply.
- If the projector is dropped or the cabinet is broken, cut off the power supply.
- If you notice smoke, strange smells or noise coming from the projector, cut off the power supply.

Please contact an Authorized Service Center for repairs, and do not attempt to repair the projector yourself.

**During a thunderstorm, do not touch the projector or the cable.**

Electric shocks can result.

**Do not do anything that might damage the power cord or the power plug.**

If the power cord is used while damaged, electric shocks, short-circuits or fire will result.

- Do not damage the power cord, make any modifications to it, place it near any hot objects, bend it excessively, twist it, pull it, place heavy objects on top of it or wrap it into a bundle.

Ask an Authorized Service Center to carry out any repairs to the power cord that might be necessary.

**Do not use anything other than the provided power cord.**

Failure to observe this will result in electric shocks or fire. Please note that if you do not use the provided power cord to ground the device on the side of the outlet, this may result in electric shocks.

**Completely insert the power plug into the wall outlet and the power connector into the projector terminal.**

If the plug is not inserted correctly, electric shocks or overheating will result.

- Do not use plugs which are damaged or wall outlets which are coming loose from the wall.

**Do not handle the power plug and power connector with wet hands.**

Failure to observe this will result in electric shocks.

**Do not overload the wall outlet.**

If the power supply is overloaded (ex., by using too many adapters), overheating may occur and fire will result.

**Clean the power plug regularly to prevent it from becoming covered in dust.**

Failure to observe this will cause a fire.

- If dust builds up on the power plug, the resulting humidity can damage the insulation.
- If not using the projector for an extended period of time, pull the power plug out from the wall outlet.

Pull the power plug out from the wall outlet and wipe it with a dry cloth regularly.

### **■ ON USE/INSTALLATION**

**Do not place the projector on soft materials such as carpets or sponge mats.**

Doing so will cause the projector to overheat, which can cause burns, fire or damage to the projector.

**Do not set up the projector in humid or dusty places or in places where the projector may come into contact with oily smoke or steam.**

Using the projector under such conditions will result in fire, electric shocks or deterioration of components. Oil may also distort the plastic and the projector could fall such as when mounted on the ceiling.

**Do not install this projector in a place which is not strong enough to take the full weight of the projector or on top of a surface which is sloped or unstable.**

Failure to observe this will cause projector to fall down or tip over the projector, and severe injury or damage could result.

**Do not install the projector in a location where people pass through.**

People may bump into the projector or trip on the power cord, which may result in fire, electric shock, or injury.

**Do not cover the air intake/exhaust ports.**

Doing so will cause the projector to overheat, which can cause fire or damage to the projector.

- Do not place the projector in narrow, badly ventilated places.
- Do not place the projector on cloth or papers, as these materials could be drawn into the air intake port.
- Provide at least 1 m (39-3/8") of space between any walls or objects and the exhaust port, and at least 50 cm (19-11/16") of space between any walls or objects and the intake port.

## **WARNING:**

**Do not look at or place your skin into the light emitted from the lens while the projector is being used. Do not enter the projection luminous flux using an optical device (such as magnifier or mirror).**

Doing so can cause burns or loss of sight.

- Strong light is emitted from the projector's lens. Do not look at or place your hands directly into this light.
- Be especially careful not to let young children look into the lens. In addition, turn off the power and disconnect the power plug when you are away from the projector.

**Do not project an image with the lens cover attached.**

Doing so can cause fire.

**Never attempt to remodel or disassemble the projector.**

High voltages can cause fire or electric shocks.

- For any inspection, adjustment and repair work, please contact an Authorized Service Center.

**Do not allow metal objects, flammable objects, or liquids to enter inside of the projector. Do not allow the projector to get wet.**

Doing so may cause short circuits or overheating, and result in fire, electric shock, or malfunction of the projector.

- Do not place containers of liquid or metal objects near the projector.
- If liquid enters inside of the projector, consult your dealer.
- Particular attention must be paid to children.

**Use the ceiling mount bracket specified by Panasonic.**

Using the ceiling mount bracket other than the specified one will result in falling accidents.

- Attach the supplied safety cable to the ceiling mount bracket to prevent the projector from falling down.

**Installation work such as mounting the projector on the ceiling should only be carried out by a qualified technician.**

If installation is not carried out and secured correctly, it can cause injury or accidents, such as electric shocks.

## **■ ACCESSORIES**

**Do not use or handle the batteries improperly, and refer to the following.**

Failure to observe this will cause burns, batteries to leak, overheat, explode or catch fire.

- Do not use unspecified batteries.
- Do not charge dry cell batteries.
- Do not disassemble dry cell batteries.
- Do not heat the batteries or place them into water or fire.
- Do not allow the + and – terminals of the batteries to come into contact with metallic objects such as necklaces or hairpins.
- Do not store or carry batteries together with metallic objects.
- Store the batteries in a plastic bag and keep them away from metallic objects.
- Make sure the polarities (+ and –) are correct when inserting the batteries.
- Do not use a new battery together with an old battery or mix different types of batteries.
- Do not use batteries with the outer cover peeling away or removed.

**If the battery fluid leaks, do not touch it with bare hands, and take the following measures if necessary.**

- Battery fluid on your skin or clothing could result in skin inflammation or injury.  
Rinse with clean water and seek medical advice immediately.
- Battery fluid coming in contact with your eyes could result in loss of sight.  
In this case, do not rub your eyes. Rinse with clean water and seek medical advice immediately.

**Do not allow children to reach the batteries.**

Accidentally swallowing them can cause physical harm.

- If swallowed, seek medical advice immediately.

**Remove the depleted batteries from the remote control promptly.**

- Leaving them in the unit may result in fluid leakage, overheating, or explosion of the batteries.

## CAUTION:

### ■ POWER

**When disconnecting the power cord, be sure to hold the power plug and power connector.**

If the power cord itself is pulled, the lead will become damaged, and fire, short-circuits or serious electric shocks will result.

**When not using the projector for an extended period of time, disconnect the power plug from the wall outlet.**

Failure to do so may result in fire or electric shock.

**Before replacing the projection lens, be sure to turn off the power and disconnect the power plug from the wall outlet.**

- Unexpected projection of light may cause injury to eyes.
- Replacing the projection lens without removing the power plug may result in electric shock.

**Disconnect the power plug from the wall outlet before carrying out any cleaning and replacing the unit.**

Failure to do so may result in electric shock.

### ■ ON USE/INSTALLATION

**Do not place heavy objects on top of the projector.**

Failure to observe this will cause the projector to become unbalanced and fall, which could result in damage or injury. The projector will be damaged or deformed.

**Do not put your weight on this projector.**

You could fall or the projector could break, and injury will result.

- Be especially careful not to let young children stand or sit on the projector.

**Do not place the projector in extremely hot locations.**

Doing so will cause the outer casing or internal components to deteriorate, or result in fire.

- Take particular care in locations exposed to direct sunlight or near heaters.

**Do not place your hands in the openings beside the optical lens, while shifting the lens.**

Failure to observe this could cause injury.

**Do not install the projector in a location where salt pollution or corrosive gas may occur.**

Doing so may result in falling due to corrosion. Also, it may result in malfunctions.

**Do not stand in front of the lens while the projector is being used.**

Doing so can cause damage and burns to clothing.

- Strong light is emitted from the projector's lens.

**Do not place objects in front of the lens while the projector is being used.**

**Do not block the projection by placing an object in front of the projection lens.**

Doing so can cause fire, damage to an object, or malfunction of the projector.

- Strong light is emitted from the projector's lens.

**Always disconnect all cables before moving the projector.**

Moving the projector with cables still attached can damage the cables, which will cause fire or electric shocks to occur.

**Never plug headphones and earphones into <VARIABLE AUDIO OUT> terminal.**

Excessive sound pressure from headphones and earphones can cause hearing loss.

**When mounting the projector on the ceiling, keep mounting screws and power cord from contact with metal parts inside the ceiling.**

Contact with metal parts inside the ceiling can cause electric shocks.

**CAUTION:**

■ **ACCESSORIES**

**When not using the projector for an extended period of time, remove the batteries from the remote control.**

Failure to observe this will cause the batteries to leak, overheat, catch fire or explode, which may result in fire or contamination of surrounding area.

■ **MAINTENANCE**

**Do not attach the air filter unit while it is wet.**

Doing so may result in electric shock or malfunctions.

- After you clean the air filter units, dry them thoroughly before reattaching them.

**Ask your dealer about cleaning inside the projector every 20 000 hours of usage as an estimated duration.**

Continuous use while dust is accumulated inside the projector may result in fire.

- For cleaning fee, ask your dealer.

**To remove the battery**

**Remote Control Battery**

**1. Press the guide and lift the cover.**

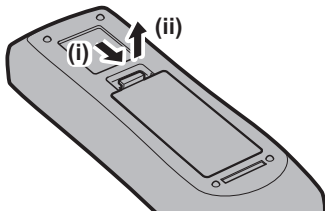

**2. Remove the batteries.**

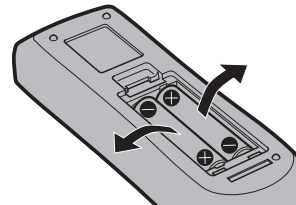

## Brazil Only

### Brasil Apenas

#### ■ Manuseio de baterias usadas



#### BRASIL

Após o uso, as pilhas e/ou baterias deverão ser entregues ao estabelecimento comercial ou rede de assistência técnica autorizada.

Cobrir os terminais positivo (+) e negativo (-) com uma fita isolante adesiva, antes de depositar numa caixa destinada para o recolhimento. O contato entre partes metálicas pode causar vazamentos, gerar calor, romper a blindagem e produzir fogo. (Fig. 1)

**Fig. 1**  
Como isolar os terminais

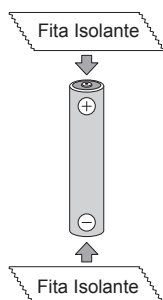

Não desmonte, não remova o invólucro, nem amasse a bateria. O gás liberado pela bateria pode irritar a garganta, danificar o lacre do invólucro ou o vazamento provocar calor, ruptura da blindagem e produzir fogo devido ao curto circuito dos terminais. Não incinere nem aqueça as baterias, elas não podem ficar expostas a temperaturas superiores a 100 °C (212 °F). O gás liberado pela bateria pode irritar a garganta, danificar o lacre do invólucro ou o vazamento provocar calor, ruptura da blindagem e produzir fogo devido ao curto circuito dos terminais provocado internamente.

Evite o contato com o líquido que vazar das baterias. Caso isto ocorra, lave bem a parte afetada com bastante água. Caso haja irritação, consulte um médico.

#### ■ Remoção das baterias

1. Pressione a guia e levante a tampa.

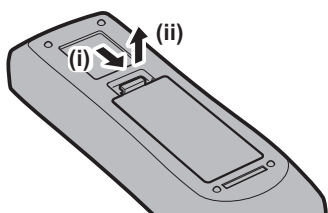

2. Remova as baterias.

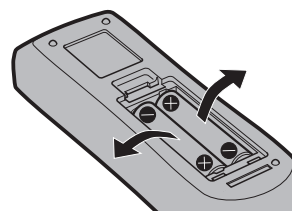

---

## ■ Trademarks

- SOLID SHINE is a trademark of Panasonic Corporation.
  - Panasonic owns patents relating to Light ID technology in Japan and other countries.
  - “LinkRay” and the  icon are trademarks of Panasonic Corporation.
  - Wi-Fi®, Wi-Fi Direct™ and Miracast™ are registered trademarks or trademarks of Wi-Fi Alliance.
  - Windows and Internet Explorer are registered trademarks or trademarks of Microsoft Corporation in the United States and other countries.
  - Mac, macOS, and Safari are trademarks of Apple Inc., registered in the United States and other countries.
  - PJLink™ is a registered trademark or pending trademark in Japan, the United States, and other countries and regions.
  - The terms HDMI and HDMI High-Definition Multimedia Interface, and the HDMI Logo are trademarks or registered trademarks of HDMI Licensing Administrator, Inc. in the United States and other countries.
  - RoomView and Crestron RoomView are registered trademarks of Crestron Electronics, Inc. Crestron Connected™ and Fusion RV are trademarks of Crestron Electronics, Inc.
  - HDBaseT™ is a trademark of HDBaseT Alliance.
  - IOS is a trademark or registered trademark of Cisco in the U.S. and other countries and is used under license.
  - Android is a trademark of Google Inc.
  - QR code is a registered trademark of DENSO WAVE INCORPORATED.
  - Adobe, Adobe Flash Player, and Adobe Reader are trademarks or registered trademarks of Adobe Systems Inc. in the United States and/or other countries.
  - Some of the fonts used in the on-screen menu are Ricoh bitmap fonts, which are manufactured and sold by Ricoh Company, Ltd.
  - This product is licensed under AVC Patent Portfolio License, VC-1 Patent Portfolio License, and MPEG-4 Visual Patent Portfolio License, and following actions except for the personal or non-profit use are not licensed.
    - Recording the image information in compliance with the AVC standard, the VC-1 standard, and the MPEG-4 Visual standard (AVC/VC-1/MPEG-4 video hereafter)
    - Playing back the AVC/VC-1/MPEG-4 video recorded by consumer practicing in a private activity, or AVC/VC-1/MPEG-4 video acquired from the licensed providerFor details, refer to the website of MPEG LA, LLC (<http://www.mpegla.com>).
  - All other names, company names, and product names mentioned in this manual are trademarks or registered trademarks of their respective owners.
- Please note that the ® and ™ symbols are not specified in this manual.

## ■ Illustrations in this manual

- Illustrations of the projector, screen, and other parts may vary from the actual product.
- Illustrations displayed on the computer screen may differ depending on the computer type and its operating system.
- Illustrations of the projector with the power cord attached are only examples. The shape of the supplied power cords varies depending on the country where you purchased the product.

## ■ Reference pages

- Reference pages in this manual are indicated as (➡ page 00).

## ■ Term

- In this manual, the “Wireless/wired remote control unit” accessory is referred to as “Remote control”.



---

## Features of the Projector

---

### High luminance and high contrast

---

- ▶ With a unique optical system which uses a new-generation laser light source, and the laser light source drive system, high luminance of 6 500 lm\*1 and high contrast of 3 000 000:1\*2 are achieved even with its compact size.

\*1 A value for PT-MZ670 and PT-MW630. A value for PT-MZ570 and PT-MW530 is 5 500 lm.

\*2 When [PICTURE MODE] is set to [DYNAMIC], and [DYNAMIC CONTRAST] is set to [1] or [2]

### Easy and highly flexible setup

---

- ▶ In addition to the lens replacement method and equipping of the lens shift, usage in a wide range of application is made possible by supporting a wide range of interfaces such as DIGITAL LINK, and by supporting the 360° installation utilizing the characteristics of solid-state light source.

### Long life and high reliability

---

- ▶ The maintenance cost for long-term operation is reduced by the unique light source cooling control technology and improvement of the dust resistance.

## Quick Steps

---

For details, refer to the corresponding pages.

1. **Set up the projector.**  
(⇒ page 35)



2. **Connect with external devices.**  
(⇒ page 51)



3. **Connect the power cord.**  
(⇒ page 57)



4. **Switch on the projector.**  
(⇒ page 59)



5. **Make initial settings.**  
(⇒ page 60)
  - Take this step when you switch on the power for the first time after purchasing the projector.



6. **Select the input signal.**  
(⇒ page 66)



7. **Adjust the image.**  
(⇒ page 67)

# Chapter 1 Preparation

---

This chapter describes things you need to know or check before using the projector.

## Precautions for use

### Lens protection material

If you purchased the projector with the standard zoom lens, remove the lens protection material before use, and store it for the future use. Move the lens position to the home position and attach the lens protection material when transporting.

If you purchased the projector with the lens sold separately, remove the lens hole cover before use, and store it for the future use. Move the lens position to the home position, remove the projection lens, and attach the lens hole cover when transporting.

For the steps to move the lens position to the home position, refer to “Moving the lens position to the home position” (➔ page 68).

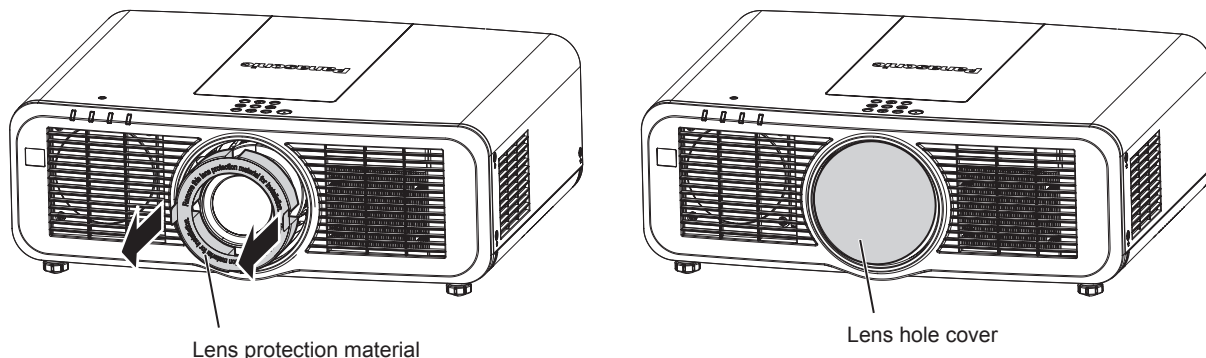

### Cautions when transporting

- When transporting the projector, hold it securely by its bottom and avoid excessive vibration and impacts. They may damage the internal components and result in malfunctions.
- Do not transport the projector with the adjustable feet extended. Doing so may damage the adjustable feet.

### Cautions when installing

#### ■ Do not set up the projector outdoors.

The projector is designed for indoor use only.

#### ■ Do not set up the projector in the following locations.

- Places where vibration and impacts occur such as in a car or vehicle: Doing so may cause damage to internal components or malfunction.
- Location close to sea or where corrosive gas may occur: The projector may fall due to corrosion. Also, failure to do so may shorten the life of the components and result in malfunction.
- Near the exhaust of an air conditioner: Depending on the conditions of use, the screen may fluctuate in rare cases due to the heated air from the air exhaust port or the hot or cooled air from the air conditioner. Make sure that the exhaust from the projector or other equipment, or the air from the air conditioner does not blow toward the front of the projector.
- Places with sharp temperature fluctuations such as near lights (studio lamps): Doing so may shorten the life of the light source, or result in deformation of the projector due to heat, which may cause malfunctions.  
Follow the operating environment temperature of the projector.
- Near high-voltage power lines or near motors: Doing so may interfere with the operation of the projector.

■ **Ask a qualified technician or your dealer for the installation work such as installing to a ceiling, etc.**

To ensure projector performance and safety, ask a qualified technician or your dealer when installing to a ceiling or in a high place.

■ **Ask a qualified technician or your dealer to install the cable wiring for DIGITAL LINK connection.**

Image and sound may be disrupted if cable transmission characteristics cannot be obtained due to inadequate installation.

■ **The projector may not work properly due to strong radio wave from the broadcast station or the radio.**

If there is any facility or equipment which outputs strong radio waves near the installation location, install the projector at a location sufficiently far from the source of the radio waves. Or, wrap the LAN cable connected to the <DIGITAL LINK/LAN> terminal using a piece of metal foil or a metal pipe which is grounded at both ends.

■ **Focus adjustment**

The high clarity projection lens is thermally affected by the light from the light source, making the focus unstable in the period just after switching on the power. It is recommended that images be projected continuously for at least 30 minutes before the focus is adjusted.

■ **Do not install the projector at an altitude of 2 700 m (8 858') or higher above sea level.**

■ **Do not use the projector in a location that the ambient temperature exceeds 45 °C (113 °F).**

Using the projector in a location that the altitude is too high or the ambient temperature is too high may reduce the life of the components or result in malfunctions.

■ **Projection in all 360° direction is possible.**

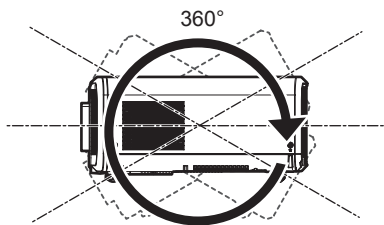

360° vertically

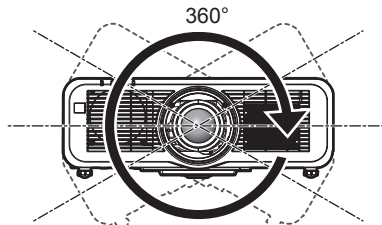

360° horizontally

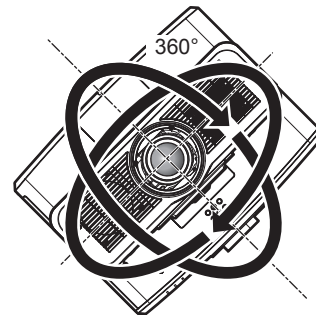

360° tilted  
(combination of vertical and horizontal)

## ■ Cautions when setting up the projector

- Use the adjustable feet only for the floor standing installation and for adjusting the angle. Using them for other purposes may damage the projector.
- When installing the projector with a method other than the floor installation using the adjustable feet or the ceiling installation, use the four screw holes for ceiling mount (as shown in the figure) to fix the projector. (Screw diameter: M6, tapping depth inside the projector: 12 mm (15/32"), screw tightening torque:  $4 \pm 0.5 \text{ N}\cdot\text{m}$ ) In such case, make sure that there is no clearance between the screw holes for ceiling mount on the projector bottom and the setting surface by inserting spacers (metallic) between them.

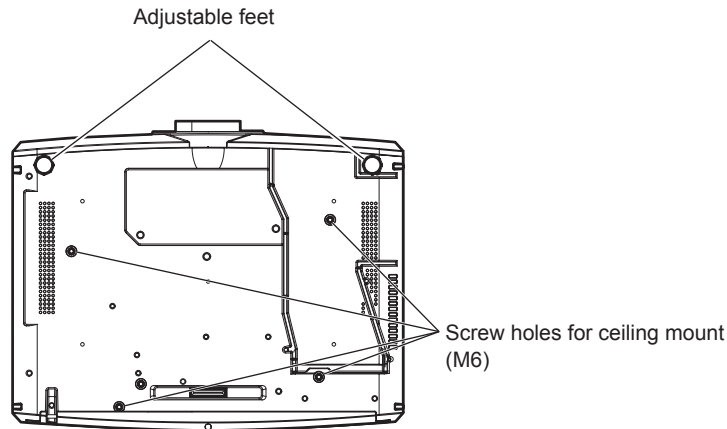

Positions of screw holes for ceiling mount and adjustable feet

- Do not stack projectors on top of each other.
- Do not use the projector supporting it by the top.
- Do not block the ventilation ports (intake and exhaust) of the projector.
- Prevent hot and cool air from the air conditioning system to blow directly to the ventilation ports (intake and exhaust) of the projector.

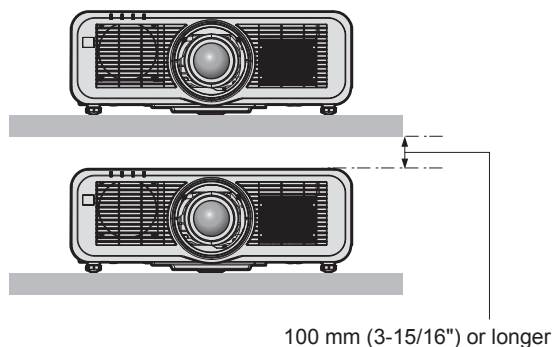
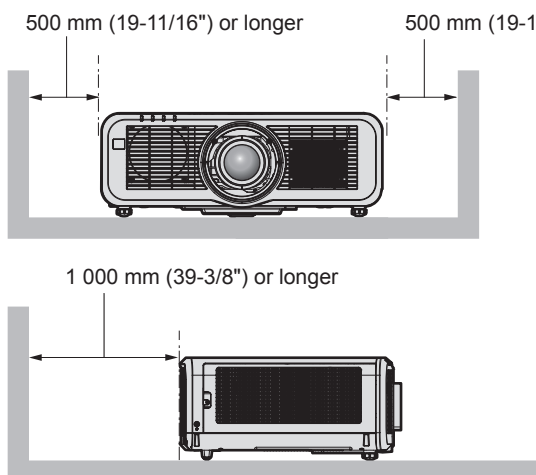
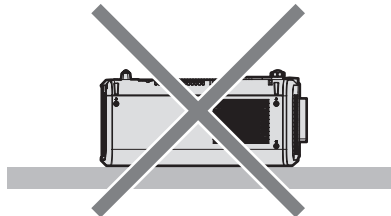
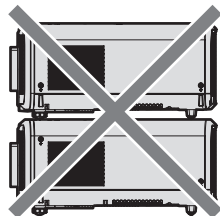

- Do not install the projector in a confined space. When installing the projector in a confined space, provide air conditioning or ventilation separately. Exhaust heat may accumulate when the ventilation is not enough, triggering the protection circuit of the projector.
- Panasonic takes no responsibility for any damage to the product caused by an inappropriate choice of location for installing the projector, even if the warranty period of the product has not expired.

## Security

When using this product, take safety measures against the following incidents.

- Personal information being leaked via this product
- Unauthorized operation of this product by a malicious third party
- Interfering or stopping of this product by a malicious third party

Take sufficient security measures.

- Make your password difficult to guess as much as possible.
- Change your password periodically. The password can be set in the [SECURITY] menu → [SECURITY PASSWORD CHANGE] or the [NETWORK/USB] menu → [Panasonic APPLICATION] → [PASSWORD CHANGE].
- Panasonic Corporation or its affiliate companies will never ask for your password directly. Do not divulge your password in case you receive such inquiries.
- The connecting network must be secured by a firewall, etc.
- Set a password for the web control and restrict the users who can log in. A password for the web control can be set in the [Change password] page of the web control screen.

### ■ Security when using the wireless LAN product

The advantage of a wireless LAN is that information can be exchanged between a computer or other such equipment and a wireless access point using radio waves, instead of using a LAN cable, as long as you are within range for radio transmissions.

On the other hand, because the radio wave can travel through an obstacle (such as a wall) and is accessible from anywhere within a given range, following problems may occur if security setting is insufficient.

- Transmitted data may be intercepted
  - A malicious third part may intentionally intercept radio waves and monitor the following transmitted data.
    - Personal information such as your ID, password, credit card number
    - Content of an Email
- Illegally accessed
  - A malicious third party may access your personal or corporate network without authorization and engage in the following types of behavior.
    - Retrieve personal and/or secret information (information leak)
    - Spread false information by impersonating a particular person (spoofing)
    - Overwrite intercepted communications and issue false data (tampering)
    - Spread harmful software such as a computer virus and crash your data and/or system (system crash)

Since most wireless LAN adapters or access points are equipped with security features to take care of these problems, you can reduce the possibility of these problems occurring when using this product by making the appropriate security settings for the wireless LAN device.

Some wireless LAN devices may not be set for security immediately after purchase. To decrease the possibility of occurrence of security problems, be sure to make all security related settings according to the operation instructions supplied with each wireless LAN device before using a wireless LAN device.

Depending on the specifications of the wireless LAN, a malicious third party may be able to break security settings by special means.

Panasonic asks customers to thoroughly understand the risk of using this product without making security settings, and recommends that the customers make security settings at their own discretion and responsibility.

### Notes regarding the wireless LAN

Radio wave in the 2.4 GHz/5 GHz band is used when the wireless LAN connection function of the projector is used. The license of wireless station is not required, but understand the following when using.

To use the wireless LAN function with the projector, it is necessary to attach the optional Wireless Module (Model No.: ET-WM300).

For details on how to attach the optional Wireless Module (Model No.: ET-WM300), refer to “Attaching the Wireless Module” (➡ page 50).

### ■ Do not use close to other wireless devices.

Following devices may be using radio wave in the same bandwidth as the projector. Using the projector close to these devices may cause the communication to be disabled or the communication speed to slow down due to interference of radio wave.

- Microwave oven, etc.

- Industrial, scientific, or medical devices, etc.
- In-plant wireless station for identifying moving vehicles used in the manufacturing lines at a plant
- Specified low power wireless station

■ **Do not use cell phone, television, or radio as much as possible close to the projector.**

Cell phone, television, or radio is using radio wave with different bandwidth from the projector, so there is no effect on the wireless LAN communication or the send/receive on these devices. However, noise may occur in the audio or video due to the radio wave from the projector.

■ **Radio wave for wireless LAN communication does not go through the reinforcing bars, metal, or concrete.**

The projector can communicate through wall or floor made of wood or glass (excluding the glass with metal mesh embedded), but it cannot communicate through wall or floor made of reinforcing bars, metal, or concrete.

■ **Do not use the projector as much as possible in a location where static electricity is generated.**

The communication via wireless LAN or wired LAN may be prone to disruption when the projector is used in a location where static electricity or noise is generated.

There is a rare case that the LAN connection may not be established due to static electricity or noise, so in such case, turn off the projector, remove the source of problematic static electricity or noise, and turn the projector back on.

■ **This device is restricted to indoor use when operated in the 2.412 to 2.472 GHz band, in the 5.18 to 5.825 GHz frequency range (Channels 36 to 165).**

■ **Using the projector outside the country**

Note that depending on countries or regions there are restrictions on the channels and frequencies at which you can use the wireless LAN.

## Light ID

---

Light ID is one of the visible light communication technologies to transfer information with fast speed and stability using flashing of light. This projector is equipped with a function to transmit the Light ID signal, and following usage is possible by utilizing the LinkRay Light ID solution service provided by Panasonic.

- By receiving the Light ID signal transmitted by the projector using the camera on a device (smartphone/tablet) and a dedicated application software, the contents linked to that Light ID signal are acquired and displayed on the screen of the device.

For details, visit the Panasonic website (<https://panasonic.net/cns/LinkRay/>).

### Note

---

- A separate contract is necessary to use the LinkRay Light ID solution service.
- The smartphone application software "LinkRay - Light ID Solution" is required. Search and download "LinkRay" from App Store or Google Play. For the latest information of devices that the operation has been verified, visit the Panasonic website (<https://panasonic.net/cns/LinkRay/>).

■ **Notes regarding Light ID function**

- The projected image may flicker when the Light ID signal is transmitted, but this is caused luminance change during the transmission of the Light ID, and it is not a malfunction.
- A striped pattern may generate on the recorded image when the projected image is recorded by a camera, etc.
- The light output will decrease while the Light ID function is used.
- The Light ID signal may become difficult to receive by a device (smartphone/tablet) in following cases.
  - When strong light such as outside light is illuminating on the projected screen
  - When a Light ID transmitting device other than this projector is installed nearby
  - When receiving a signal in a location far from the screen
  - When receiving a signal in a location that is angled against the screen
  - When the light reflection loss is large due to the screen characteristics
  - When the size of the projected image is small
  - When the displayed projected image is dark

- When using a laser format bar code reader, take care not to illuminate the bar code reading surface with the projection light or its reflected light. Doing so may cause bar code reader not to read or misread.
- The Light ID function of the projector is not guaranteed to operate on all devices.

### DIGITAL LINK

“DIGITAL LINK” is a technology to transmit the video, audio, Ethernet, and serial control signals using a twisted pair cable by adding unique functions by Panasonic to the HDBaseT™ communication standard formulated by HDBaseT Alliance.

This projector supports the optional Panasonic DIGITAL LINK output supported device (Model No.: ET-YFB100G, ET-YFB200G) and peripheral devices by other manufacturers (twisted-pair-transmitters such as the “XTP transmitter” of Extron Electronics) based on the same HDBaseT™ standard. For the devices of other manufacturers that the operation has been verified with this projector, visit the Panasonic website (<https://panasonic.net/cns/projector/>). Note that the verification for devices of other manufacturers has been made for the items set by Panasonic Corporation, and not all the operations have been verified. For operation or performance problems caused by the devices of other manufacturers, contact the respective manufacturers.

### Application software supported by the projector

The projector supports following application software. For details or downloading each application software, visit the Panasonic website (<https://panasonic.net/cns/projector/>).

- **Logo Transfer Software**

This application software transfers the original image, such as company logo, which is projected at the start, to the projector.

- **Smart Projector Control**

This application software sets and adjusts the projector connected via LAN using a smartphone or a tablet.

- **Multi Monitoring & Control Software**

This application software monitors and controls the multiple display devices (projector and flat panel display) connected to an intranet.

- **Early Warning Software**

This plug-in software monitors the status of the display devices and their peripherals within an intranet, and notifies of abnormality of such equipment and detects the signs of possible abnormality. “Early Warning Software” is preinstalled in the “Multi Monitoring & Control Software”. To use the early warning function of this plug-in software, install “Multi Monitoring & Control Software” in the PC to be used. By enabling the early warning function, it will notify of the approximate time to replace the consumables for the display devices, to clean each part of the display devices, and to replace the components of the display devices, allowing to execute maintenance in advance.

The early warning function can be used by registering maximum of 2048 display devices free of charge for 90 days after installing the “Multi Monitoring & Control Software” into a PC. To continuously use after the 90 days, it is necessary to purchase the license of “Early Warning Software” (ET-SWA100 Series) and perform the activation. Also, depending on the type of license, the number of display devices that can be registered for monitoring varies. For details, refer to the Operating Instructions of “Multi Monitoring & Control Software”.

- **Wireless Manager ME6.4**

This application software transmits the computer screen to the projector via wireless LAN or wired LAN.

Simultaneous projection from one computer to multiple projectors, or simultaneous projection from multiple computers to one projector is possible.

- **Plug and Share**

This application software makes it possible to project the computer screen with the projector easily by omitting the selection of the device when connecting the computer via network by pairing a projector and a computer using the USB memory.

- **Wireless Projector**

This application software for iOS/Android is used to project files such as PDF or image by transmitting to the projector via wireless LAN.

### Disposal

To dispose of the product, ask your local authorities or dealer for correct methods of disposal. Also, dispose of the product without disassembling.

### Storing

To store the projector, store in a dry room.



## Cautions on use

---

### ■ To get a good picture quality

In order to view a beautiful image in higher contrast, prepare an appropriate environment. Draw curtains or blinds over windows and turn off any lights near the screen to prevent outside light or light from indoor lamps from shining onto the screen.

### ■ Do not touch the surface of the projection lens with your bare hands.

If the surface of the projection lens becomes dirty from fingerprints or anything else, this will be magnified and projected onto the screen.

### ■ LCD panel

The LCD panel is manufactured by a technology with extremely high precision, but there may be missing pixels or pixels that is constantly illuminated in a rare case. Note that these phenomenon are not malfunction.

Also, a residual image may remain in the image of the LCD panel when a still image is projected for long time, and in such case, project a full white image for 1 hour or longer. Note that the residual image may not be completely erased.

### ■ Optical parts

The replacement cycle for the optical parts such as the LCD panel or polarization plate may become shorter even if it is used for less than one year when the ambient temperature is high or in an environment with large amount of dust or cigarette smoke. For details, consult your dealer.

### ■ Light source

The light source of the projector uses lasers, and has the following characteristics.

- Depending on the operating environment temperature, the luminance of the light source will decrease.  
The higher the temperature becomes, the more the luminance of the light source decreases.
- The luminance of the light source will decrease by duration of usage.

If brightness is noticeably reduced and the light source does not turn on, ask your dealer to clean inside the projector or replace the light source unit.

### ■ Computer and external device connections

When connecting a computer or an external device, read this manual carefully regarding the use of power cords and shielded cables as well.

## Accessories

Make sure that the following accessories are provided with your projector. Numbers enclosed in < > show the number of accessories.

**Wireless/wired remote control unit <1>**  
(N2QAYA000150)



For Taiwan  
(1JP1RZ970) <1>

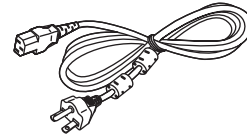

**Power cord**  
(TXFSX01RXQZ)

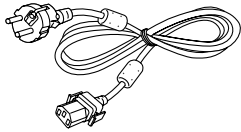

(TXFSX01RXRZ)

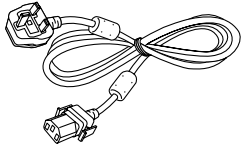

(TXFSX01RWDZ)

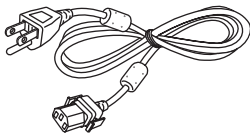

(TXFSX02UTRZ)

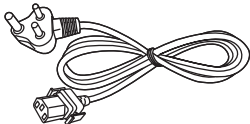

**CD-ROM <1>**  
(1JK1MZ670U)



(Operating Instructions are included.)

**AAA/R03 or AAA/LR03 battery <2>**  
(For remote control unit)

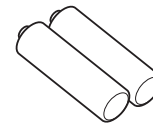

**Lens cover <1>**  
(Only models with lens)  
(6103626291)



### Attention

- After unpacking the projector, discard the power cord cap and packaging material properly.
- Do not use the supplied power cord for devices other than this projector.
- For missing accessories, consult your dealer.
- Store small parts in an appropriate manner, and keep them away from small children.

### Note

- The type and number of the supplied power cords vary depending on the country or region where you purchased the product.
- The model numbers of accessories are subject to change without prior notice.

## Optional accessories

Optional accessories (product name)		Model No.
Projection lens	Zoom Lens	ET-ELW20, ET-ELT20, ET-ELS20* <sup>1</sup> , ET-ELT21, ET-ELW22
	Fixed-focus Lens	ET-ELW21
Ceiling Mount Bracket		ET-PKD120H (for High Ceilings) ET-PKD120S (for Low Ceilings) ET-PKE301B (Projector Mount Bracket)* <sup>2</sup>
Early Warning Software (Basic license/3-year license)		ET-SWA100 Series* <sup>3</sup>
Digital Interface Box		ET-YFB100G
DIGITAL LINK Switcher		ET-YFB200G
Replacement Filter Unit		ET-RFM100
Wireless Module		ET-WM300* <sup>4</sup>

\*1 This product can be purchased in the U.S., Canada and the European Communities.

This product is equivalent to the standard zoom lens attached to the projector models with standard zoom lens.

\*2 When the projector is mounted to the existing Ceiling Mount Bracket (in combination with the Model No.: ET-PKD120H (for High Ceilings) or ET-PKD120S (for Low Ceilings), and the Model No.: ET-PKE300B (Projector Mount Bracket)), it is necessary to replace the drop-prevention wire rope with the one corresponding to this projector. Consult your dealer.

**Drop-prevention set (service model no.: DPPW1004ZA/X1)**

\*3 The suffix of the Model No. differs according to the license type.

\*4 This product cannot be purchased in some countries. For details, contact your dealer.

### Note

- The model numbers of optional accessories are subject to change without prior notice.

# About your projector

## Remote control

### ■ Front

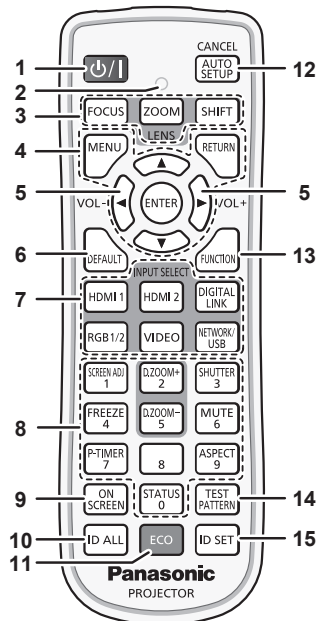

### ■ Top

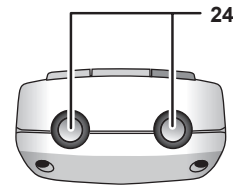

### ■ Bottom

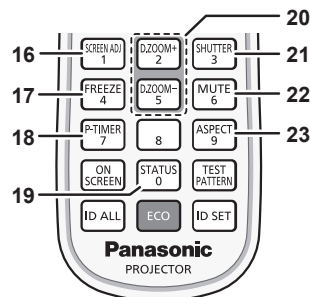
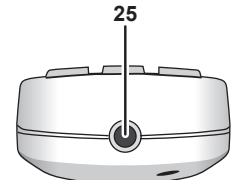

#### 1 Power <⏻/⏻> button

(⏻: Standby, |: Power on)

Sets the projector to the state where the projector is turned off (standby mode) when the <MAIN POWER> switch on the projector is set to <ON> and in projection mode.

Sets the projector to projection mode when the power is switched off (standby mode).

#### 2 Remote control indicator

Blinks if any button in the remote control is pressed.

#### 3 Lens buttons (<FOCUS>, <ZOOM>, <SHIFT>)

Adjusts the focus, zoom, and lens shift of the lens.

(➡ page 67)

#### 4 <MENU> button/<RETURN> button/<ENTER> button/ ▲▼◀▶ buttons

Used to navigate through the menu screen. (➡ page 79)

▲▼◀▶ buttons are also used to enter the password in [SECURITY] or enter characters.

#### 5 <VOL-> button/<VOL+> button

Adjusts the volume of the built-in speaker and the audio output.

(➡ page 72)

#### 6 <DEFAULT> button

Resets the content of the displayed sub-menu to the factory default. (➡ page 80)

#### 7 Input selection buttons (<HDMI 1>, <HDMI 2>, <DIGITAL LINK>, <RGB1/2>, <VIDEO>, <NETWORK/USB>)

Switches the input signal to project. (➡ page 66)

#### 8 Number (<0> - <9>) buttons

Used for entering an ID number or a password in a multiple projector environment.

#### 9 <ON SCREEN> button

Switches the on-screen display function on (display) or off (hide). (➡ page 72)

#### 10 <ID ALL> button

Used to simultaneously control all the projectors with a single remote control in a multiple projector environment.

(➡ page 33)

#### 11 <ECO> button

Displays the setting screen relating to ECO management. (➡ pages 76, 113)

#### 12 <AUTO SETUP/CANCEL> button

Automatically adjusts the image display position while projecting the image.

[PROGRESS] is displayed while in automatic adjustment.

(➡ page 73)

Also used for cancel operation during digital zoom and the operation of the Memory Viewer screen, or while the standby screen for Panasonic APPLICATION input is displayed.

During MIRRORING input, the receiving device name and the URL to access the projector are displayed at the top left of the screen. (➡ page 183)

#### 13 <FUNCTION> button

Assigns a frequently used operation as a shortcut button.

(➡ page 75)

#### 14 <TEST PATTERN> button

Displays the test pattern. (➡ page 75)

#### 15 <ID SET> button

Sets the ID number of the remote control in a multiple projector environment. (➡ page 33)

#### 16 <SCREEN ADJ> button

Used to correct the distortion of the projected image. (➡ pages 73, 92)

#### 17 <FREEZE> button

Used when pausing the image and turning off the audio.

(➡ page 72)

#### 18 <P-TIMER> button

Operates the presentation timer function. (➡ page 75)

#### 19 <STATUS> button

Displays the projector information.

#### 20 <D.ZOOM+> button/<D.ZOOM-> button

Enlarges or reduces the image. (➡ page 74)

#### 21 <SHUTTER> button

Used when temporarily turning off the image and audio.

(➡ page 71)

#### 22 <MUTE> button

Used when temporarily turning off the audio. (➡ page 71)

#### 23 <ASPECT> button

Switches the aspect ratio of the image. (➡ page 75)

#### 24 Remote control signal transmitter

### 25 Remote control wired terminal

This is a terminal used to connect to the projector via a cable when the remote control is used as a wired remote control.

(➔ page 33)

### Attention

---

- Do not drop the remote control.
- Avoid contact with liquids or moisture.
- Do not attempt to modify or disassemble the remote control.
- Observe the following instructions that are indicated on the caution label at the back of the remote control:
  - Do not use old battery with new one.
  - Do not use batteries other than the type specified.
  - Be sure the batteries are inserted properly.

For other instructions, read the instructions related to batteries that are described in "Read this first!".

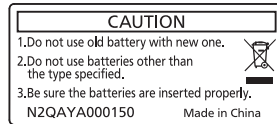

Caution label at the back of the remote control

### Note

---

- When operating the remote control by directly pointing at the remote control signal receiver of the projector, operate the remote control within a distance approximately 30 m (98'5") from the remote control signal receiver. The remote control can control at angles of up to  $\pm 30^\circ$  vertically and horizontally, but the effective control range may be reduced.
- If there are any obstacles between the remote control and the remote control signal receiver, the remote control may not operate properly.
- The signal will be reflected off the screen. However, the operating range may be limited from light reflection loss due to the screen material.
- If the remote control signal receiver directly receives strong light, such as fluorescent light, the remote control may not operate properly. Use it in a place distant from the light source.
- The power indicator <ON (G)/STANDBY (R)> will blink if the projector receives a remote control signal.

## Projector body

### ■ Front

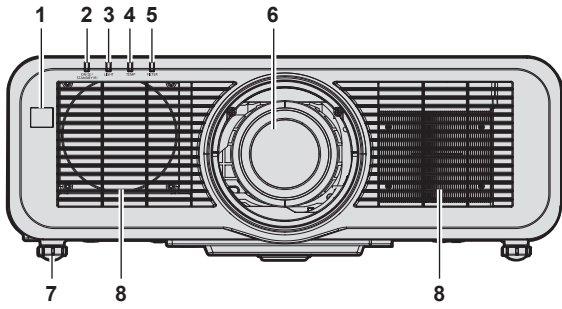

### ■ Side

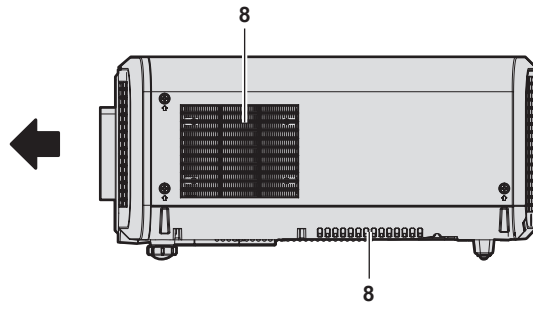

### ■ Rear

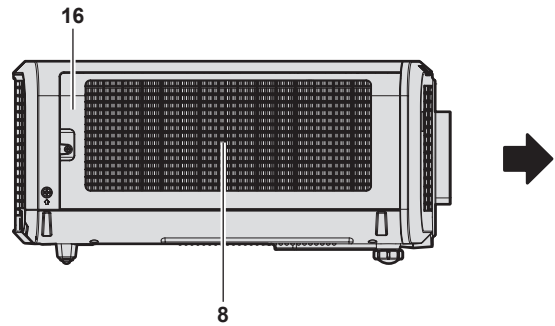
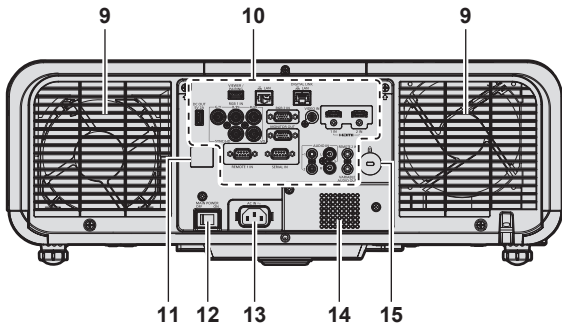

### ■ Top

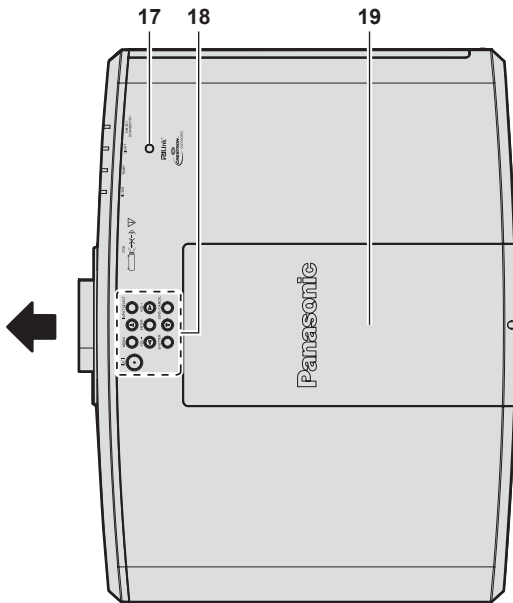

### ■ Bottom

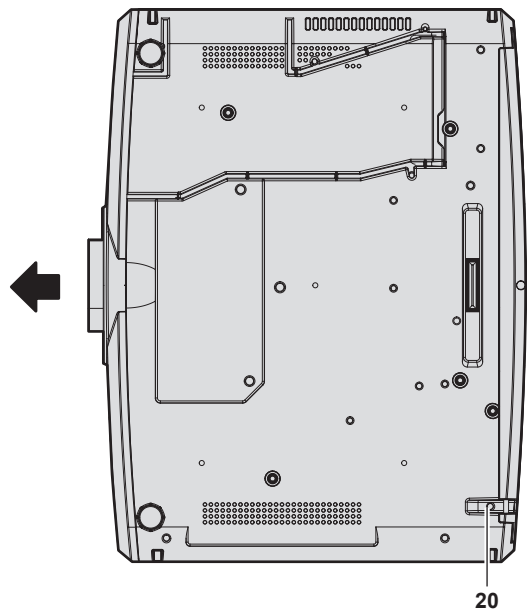

← : Projection direction

- 1 **Remote control signal receiver (front)**
- 2 **Power indicator <ON (G)/STANDBY (R)>**  
Indicates the status of the power.
- 3 **Light source indicator <LIGHT>**  
Indicates the status of the light source.
- 4 **Temperature indicator <TEMP>**  
Indicates the internal temperature status.
- 5 **Filter indicator <FILTER>**  
Indicates the status of the air filter unit.
- 6 **Projection lens**
- 7 **Adjustable feet**  
Adjusts the projection angle.
- 8 **Air intake port**

- 9 **Air exhaust port**
- 10 **Connecting terminals** (→ page 32)
- 11 **Remote control signal receiver (rear)**
- 12 **<MAIN POWER> switch**  
Turns on/off the main power.
- 13 **<AC IN> terminal**  
Connect the supplied power cord.
- 14 **Speaker**
- 15 **Security slot**  
This security slot is compatible with the Kensington security cables.
- 16 **Air filter cover**  
There is the air filter unit inside.

17 Luminance sensor (➔ page 87)

18 Control panel (➔ page 31)

19 Top slide cover

There is the wireless module connection terminal inside.  
(➔ page 50)

20 Burglar hook port

Attaches a burglar prevention cable, etc.

**Attention**

- Do not block the ventilation ports (intake and exhaust) of the projector.  
The components may deteriorate faster if cooling inside the projector is inhibited.

**Control panel**

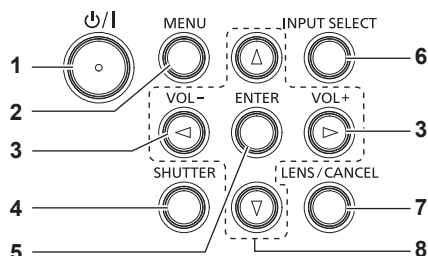

**1 Power <⏻/⏻> button**

(⏻: Standby, ⏻: Power on)

Sets the projector to the state where the projector is turned off (standby mode) when the <MAIN POWER> switch on the projector is set to <ON> and in projection mode.

Sets the projector to projection mode when the power is switched off (standby mode).

**2 <MENU> button**

Displays or hides the main menu. (➔ page 79)

Returns to the previous menu when a sub-menu is displayed.

**3 <VOL-> button/<VOL+> button**

Adjusts the volume of the built-in speaker and the audio output. (➔ page 72)

**4 <SHUTTER> button**

Used to turn off the image and audio temporarily. (➔ page 71)

**5 <ENTER> button**

Determines and executes an item in the menu screen.

**6 <INPUT SELECT> button**

Switches the input signal to project. (➔ page 66)

**7 <LENS/CANCEL> button**

Adjusts the focus, zoom, and lens shift of the lens.

(➔ page 67)

Also used for cancel operation during digital zoom and operation in theMemory Viewer screen, or while the standby screen for MIRRORING input or Panasonic APPLICATION input is displayed.

**8 ▲▼◀▶ buttons**

Selects an item in the menu screen, changes the setting, and adjusts the level.

Also used to enter a password in the [SECURITY] menu or enter characters.

■ Connecting terminals

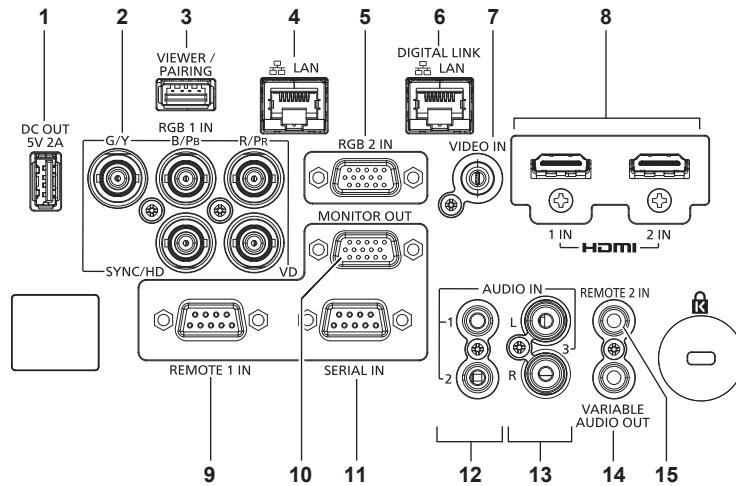

- |   |   |
|---|---|
| <p><b>1 &lt;DC OUT&gt; terminal</b><br/>This is the USB terminal only used for power supply. (DC 5 V, maximum 2.0 A)<br/>This can be used when the projector is in projecting status and when power is to be supplied to the wireless display adapter, etc.</p> <p><b>2 &lt;RGB 1 IN&gt; terminals (&lt;G/Y&gt;, &lt;B/P<sub>B</sub>&gt;, &lt;R/P<sub>R</sub>&gt;, &lt;SYNC/HD&gt;, &lt;VD&gt;)</b><br/>This is a terminal to input the RGB signal or YC<sub>B</sub>C<sub>R</sub>/YP<sub>B</sub>P<sub>R</sub> signal.</p> <p><b>3 &lt;VIEWER/PAIRING&gt; terminal</b><br/>This is a terminal to connect the USB memory when using the Memory Viewer function, pairing function, or data cloning function. (➔ pages 185, 193)</p> <p><b>4 &lt;LAN&gt; terminal</b><br/>This is the LAN terminal to connect to the network.<br/>This also supports the image transfer from the image transfer application software. (➔ page 153)</p> <p><b>5 &lt;RGB 2 IN&gt; terminal</b><br/>This is a terminal to input the RGB signal or YC<sub>B</sub>C<sub>R</sub>/YP<sub>B</sub>P<sub>R</sub> signal.</p> <p><b>6 &lt;DIGITAL LINK/LAN&gt; terminal</b><br/>This is a terminal to connect a device that transmits video signal or audio signal via the LAN terminal. Also, this is the LAN terminal to connect to the network.</p> | <p><b>7 &lt;VIDEO IN&gt; terminal</b><br/>This is a terminal to input video signal.</p> <p><b>8 &lt;HDMI 1 IN&gt; terminal/&lt;HDMI 2 IN&gt; terminal</b><br/>This is a terminal to input the HDMI signal.</p> <p><b>9 &lt;REMOTE 1 IN&gt; terminal</b><br/>This is a terminal to remotely control the projector using the external control circuit.</p> <p><b>10 &lt;MONITOR OUT&gt; terminal</b><br/>This is a terminal to output the RGB signal or the YC<sub>B</sub>C<sub>R</sub>/YP<sub>B</sub>P<sub>R</sub> signal input in the &lt;RGB 1 IN&gt; terminal or the &lt;RGB 2 IN&gt; terminal. When the input is switched to RGB1 or RGB2, corresponding input signal is output.</p> <p><b>11 &lt;SERIAL IN&gt; terminal</b><br/>This is the RS-232C compatible terminal to externally control the projector by connecting a computer.</p> <p><b>12 &lt;AUDIO IN 1&gt; terminal/&lt;AUDIO IN 2&gt; terminal</b><br/>This is a terminal to input audio.</p> <p><b>13 &lt;AUDIO IN 3&gt; terminal</b><br/>This is a terminal to input audio signal. There are right input &lt;R&gt; and left input &lt;L&gt;.</p> <p><b>14 &lt;VARIABLE AUDIO OUT&gt; terminal</b><br/>This is a terminal to output the audio signal input to the projector.</p> <p><b>15 &lt;REMOTE 2 IN&gt; terminal</b><br/>This is a terminal to connect the remote control with a cable when controlling the projector with a wired remote control.</p> |
|---|---|

**Attention**

- When a LAN cable is directly connected to the projector, the network connection must be made indoors.  
The signal may deteriorate due to the effect of noise or cable length.



# Preparing the remote control

## Inserting and removing the batteries

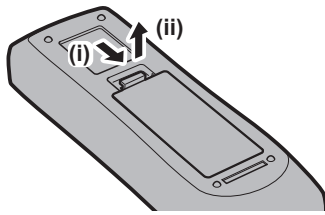

Fig. 1

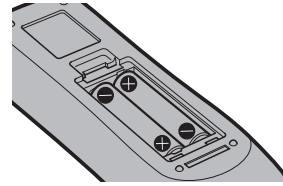



Fig. 2

- 1) Open the cover. (Fig. 1)
- 2) Insert the batteries and close the cover (insert the  side first). (Fig. 2)
  - When removing the batteries, perform the steps in reverse order.

## When using the multiple projectors

When you use the multiple projectors together, you can operate all the projectors simultaneously or each projector individually using single remote control, if a unique ID number is assigned to each projector.

When using the projectors by setting the ID numbers, set the ID number of the projector body after initial settings have been completed. Then, set the ID number of the remote control. For initial settings, refer to “When the initial setting screen is displayed” (➔ page 60).

The factory default ID number of the projector (projector body and remote control) is set to [ALL], so you can use it as it is. Set the ID numbers of the projector body and remote control as necessary.

For details on setting the ID number of the remote control, refer to “Setting ID number of the remote control” (➔ page 76).

### Note

- Set the ID number of the projector body from the [PROJECTOR SETUP] menu → [PROJECTOR ID].

## Connecting the remote control to the projector with a cable

To control the projector with a wired remote control, connect the remote control wired terminal of the remote control with the <REMOTE 2 IN> terminal of the projector with commercially available M3 stereo mini plug cable. This is effective when using the projector in location where there is an obstacle between the projector and the remote control or location that is affected by the outside light.

- The wireless remote control cannot be used when a cable is connected to the <REMOTE 2 IN> terminal of the projector.

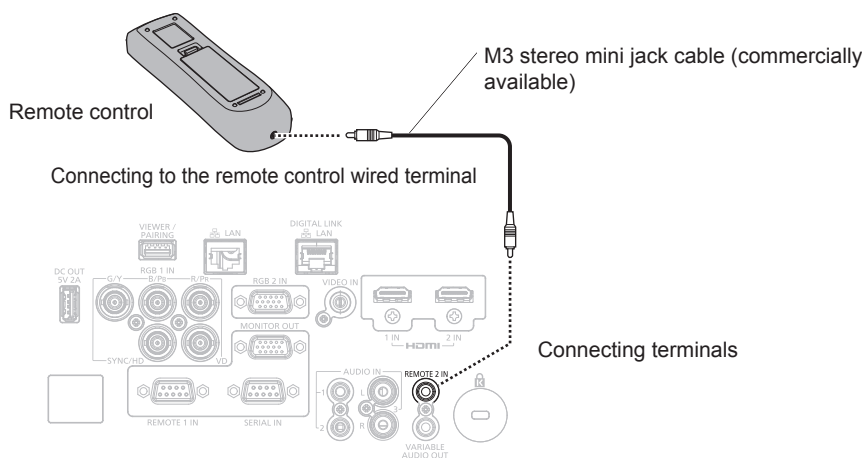

### Attention

- Use a cable that is 15 m (49'3") or shorter, with 2 core shielded. The remote control may not operate when the length of the cable exceeds 15 m (49'3") or when the shielding of the cable is inadequate.

# Chapter 2 **Getting Started**

---

This chapter describes things you need to do before using the projector such as the setup and connections.

# Setting up

## Installation mode

The installation modes of the projector are as follows. Set [FRONT/REAR]/[FLOOR/CEILING] in the [PROJECTOR SETUP] menu → [PROJECTION METHOD] (▶ page 112) depending on the installation mode.

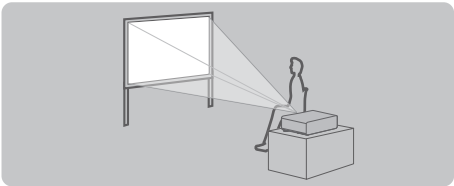
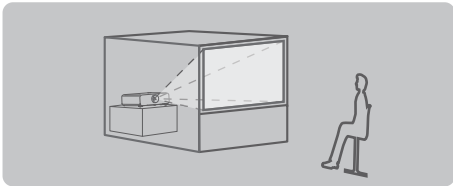
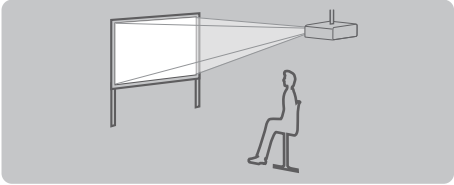
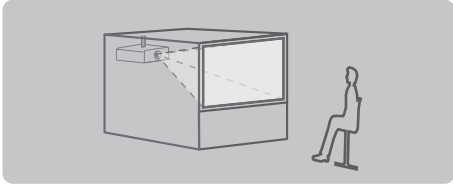
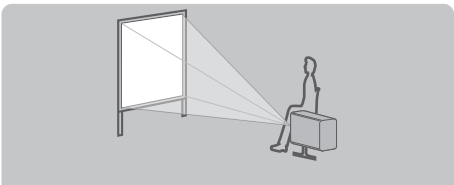
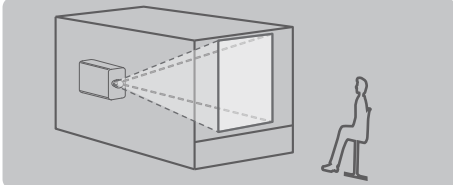
<b>Setting on a desk/floor and projecting forward</b> 		<b>Setting on a desk/floor and projecting from rear</b> (Using the translucent screen) 	
<b>Menu item</b>	<b>Setting value</b>	<b>Menu item</b>	<b>Setting value</b>
[FRONT/REAR]	[FRONT]	[FRONT/REAR]	[REAR]
[FLOOR/CEILING]	[AUTO] or [FLOOR]	[FLOOR/CEILING]	[AUTO] or [FLOOR]
<b>Mounting on the ceiling and projecting forward</b> 		<b>Mounting on the ceiling and projecting from rear</b> (Using the translucent screen) 	
<b>Menu item</b>	<b>Setting value</b>	<b>Menu item</b>	<b>Setting value</b>
[FRONT/REAR]	[FRONT]	[FRONT/REAR]	[REAR]
[FLOOR/CEILING]	[AUTO] or [CEILING]	[FLOOR/CEILING]	[AUTO] or [CEILING]
<b>Portrait setting and projecting forward</b> 		<b>Portrait setting and projecting from rear</b> (Using the translucent screen) 	
<b>Menu item</b>	<b>Setting value</b>	<b>Menu item</b>	<b>Setting value</b>
[FRONT/REAR]	[FRONT]	[FRONT/REAR]	[REAR]
[FLOOR/CEILING]	Set in accordance with the image to project.	[FLOOR/CEILING]	Set in accordance with the image to project.

### Note

- In the portrait setting, the on-screen menu is displayed sideways. To display the on-screen menu vertically, go to the [DISPLAY OPTION] menu → [ON-SCREEN DISPLAY] (▶ page 104) and change the [OSD ROTATION] setting.
- The projector has a built-in angle sensor. The attitude of the projector is automatically detected by setting [FLOOR/CEILING] to [AUTO] in the [PROJECTOR SETUP] menu → [PROJECTION METHOD].

### ■ Angle sensor

The range of the installation attitude that is detected by the angle sensor built-in the projector is as follows.

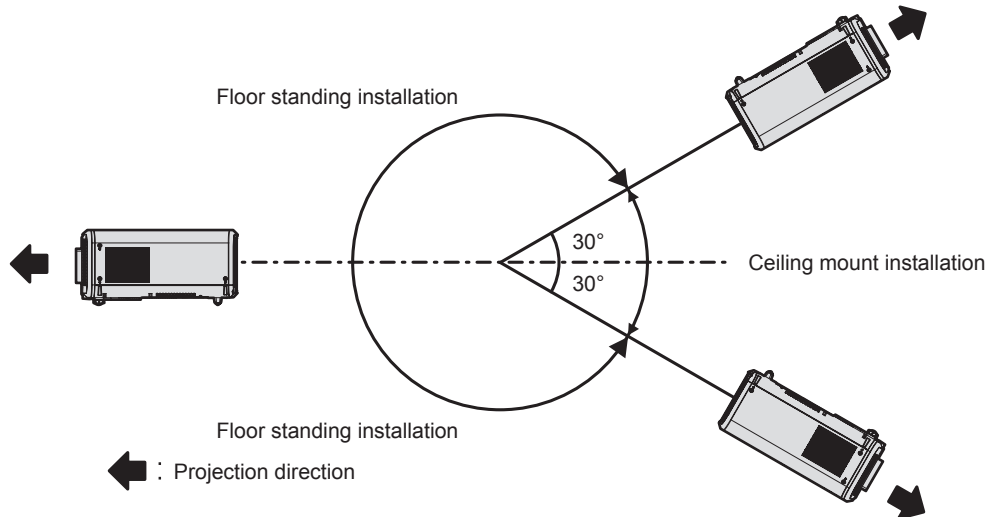

### Parts for installation (optional)

The optional Ceiling Mount Bracket is required. The Ceiling Mount Bracket (Model No.: ET-PKD120H (for High Ceilings) or ET-PKD120S (for Low Ceilings)) is used together with the Ceiling Mount Bracket (Model No.: ET-PKE301B (Projector Mount Bracket)).

**Model No.: ET-PKD120H (for High Ceilings), ET-PKD120S (for Low Ceilings), ET-PKE301B (Projector Mount Bracket)**

When the projector is mounted to the existing Ceiling Mount Bracket (in combination with the Model No.: ET-PKD120H (for High Ceilings) or ET-PKD120S (for Low Ceilings), and the Model No.: ET-PKE300B (Projector Mount Bracket)), it is necessary to replace the drop-prevention wire rope with the one corresponding to this projector. Consult your dealer.

**Drop-prevention set (service model no.: DPPW1004ZA/X1)**

- Be sure to use the Ceiling Mount Bracket specified for this projector.
- Refer to the Installation Instructions of the Ceiling Mount Bracket when installing and setting up the projector.

### Attention

- To ensure projector performance and security, installation of the Ceiling Mount Bracket must be carried out by your dealer or a qualified technician.

## Projected image and throw distance

Install the projector referring to the projected image size and projection distance. Image size and image position can be adjusted in accordance with the screen size and screen position.

- Following illustration is prepared on the assumption that the projected image size and position have been aligned to fit full in the screen.

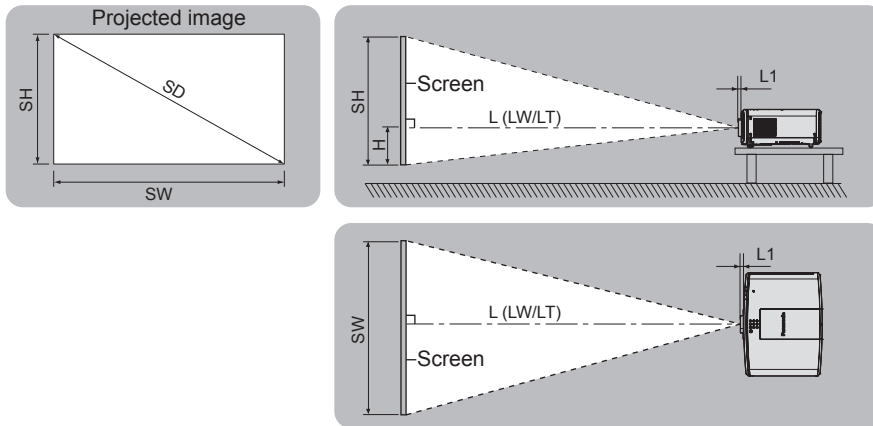

(Unit: m)

L (LW/LT)*1	Projection distance
L1	Lens protrusion dimension
SH	Projected image height
SW	Projected image width
H	Distance from the lens center to the bottom edge of the projected image
SD	Projected image size

- \*1 LW: Minimum projection distance when the Zoom Lens is used  
 LT: Maximum projection distance when the Zoom Lens is used

(Unit: m)

Projection lens Model No.	Dimension for L1 (approximate value)
Standard zoom lens/ET-ELS20	0.015
ET-ELW21	0.005
ET-ELW22	0.050
ET-ELW20	0.035
ET-ELT20	0.036
ET-ELT21	0.032

### Attention

- Before setting up, read "Precautions for use" (➡ page 19).
- Do not use the projector and the high-power laser equipment in the same room. The LCD panel may be damaged if a laser beam hits the projection lens surface.

**[SCREEN ADJUSTMENT] projection range**

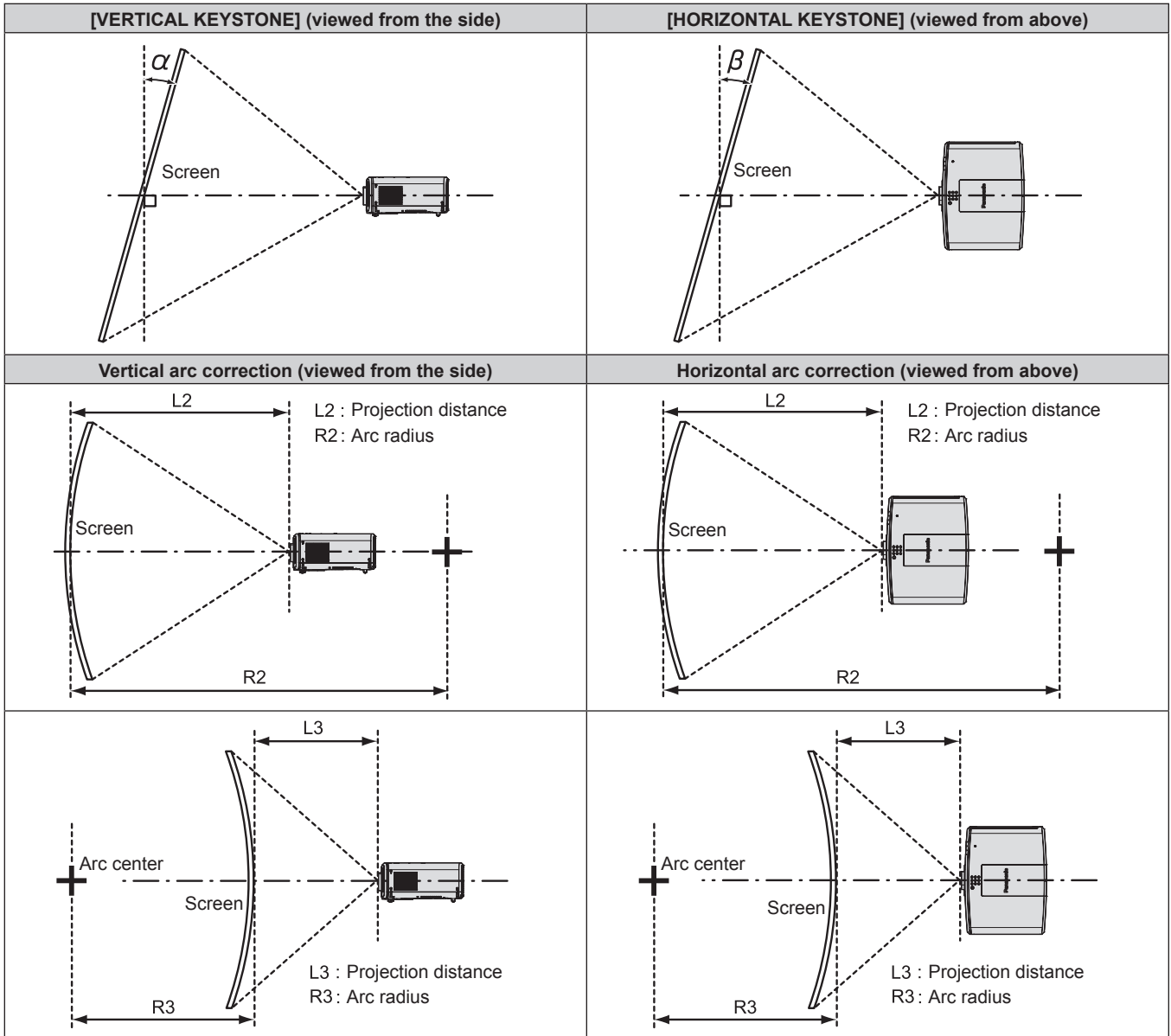

PT-MZ670, PT-MZ570

Projection lens Model No.	Throw ratio*1	Only [KEYSTONE] used*2		[KEYSTONE] and [CURVED CORRECTION] used together				Only [CURVED CORRECTION] used	
		Vertical keystone correction angle $\alpha$ (°)	Horizontal keystone correction angle $\beta$ (°)	Vertical keystone correction angle $\alpha$ (°)	Horizontal keystone correction angle $\beta$ (°)	Min. value of R2/L2	Min. value of R3/L3	Min. value of R2/L2	Min. value of R3/L3
Standard zoom lens/ ET-ELS20	1.6-2.8	±25	±30	±20	±15	0.9	1.8	0.5	1.0
ET-ELW21	0.8	±22	±15	±8	±8	1.7	4.3	1.0	2.6
ET-ELW22	0.8-1.0	±22	±15	±8	±8	1.7	4.3	1.0	2.6
ET-ELW20	1.2-1.7	±25	±30	±20	±15	1.2	3.1	0.7	1.8
ET-ELT20	2.7-4.5	±25	±30	±20	±15	0.6	1.1	0.3	0.6
ET-ELT21	4.4-7.1	±25	±30	±20	±15	0.4	0.7	0.2	0.4

\*1 The throw ratio is a value calculated by dividing the projection distance by the projected image width.

For details of the projection distance and the projected image width, refer to “Projected image and throw distance” (➔ page 37).

\*2 When [VERTICAL KEYSTONE] and [HORIZONTAL KEYSTONE] are used simultaneously, correction cannot be made exceeding total of 55°.

PT-MW630, PT-MW530

Projection lens Model No.	Throw ratio*1	Only [KEYSTONE] used*2		[KEYSTONE] and [CURVED CORRECTION] used together				Only [CURVED CORRECTION] used	
		Vertical keystone correction angle $\alpha$ (°)	Horizontal keystone correction angle $\beta$ (°)	Vertical keystone correction angle $\alpha$ (°)	Horizontal keystone correction angle $\beta$ (°)	Min. value for R2/L2	Min. value for R3/L3	Min. value for R2/L2	Min. value for R3/L3
Standard zoom lens/ ET-ELS20	1.6-2.8	±35	±35	±20	±15	0.9	1.8	0.5	1.0
ET-ELW21	0.8	±22	±15	±8	±8	1.7	4.3	1.0	2.6
ET-ELW22	0.8-1.0	±22	±15	±8	±8	1.7	4.3	1.0	2.6
ET-ELW20	1.2-1.7	±35	±35	±20	±15	1.2	3.1	0.7	1.8
ET-ELT20	2.7-4.5	±35	±35	±20	±15	0.6	1.1	0.3	0.6
ET-ELT21	4.4-7.1	±35	±35	±20	±15	0.4	0.7	0.2	0.4

\*1 The throw ratio is a value calculated by dividing the projection distance by the projected image width.

For details of the projection distance and the projected image width, refer to “Projected image and throw distance” (➔ page 37).

\*2 When [VERTICAL KEYSTONE] and [HORIZONTAL KEYSTONE] are used simultaneously, correction cannot be made exceeding total of 55°.

**Note**

- When [SCREEN ADJUSTMENT] is used, the focus of the entire screen may be lost as correction increases.
- Make the curved screen a circular arc shape with one part of a perfect circle removed.

**Projection distance of each projection lens**

A ±5 % error in listed projection distances may occur.

When [SCREEN ADJUSTMENT] is used, distance is corrected to become smaller than the specified image size.

**PT-MZ670, PT-MZ570**

■ When the screen aspect ratio is 16:10

(Unit: m)

Lens type			Zoom Lens										Fixed-focus Lens
Projection lens Model No.			Standard zoom lens/ET-ELS20		ET-ELW22		ET-ELW20		ET-ELT20		ET-ELT21		ET-ELW21
Throw ratio <sup>*1</sup>			1.6-2.8:1		0.8-1.0:1		1.2-1.7:1		2.7-4.5:1		4.4-7.1:1		0.8:1
Projected image size			Projection distance (L)										
Diagonal (SD)	Height (SH)	Width (SW)	Min. (LW)	Max. (LT)	Min. (LW)	Max. (LT)	Min. (LW)	Max. (LT)	Min. (LW)	Max. (LT)	Min. (LW)	Max. (LT)	Fixed
1.016 (40")	0.538	0.862	1.36	2.35	—	—	1.02	1.41	2.29	3.81	3.72	6.03	0.63
1.270 (50")	0.673	1.077	1.71	2.95	—	—	1.29	1.77	2.89	4.79	4.70	7.59	0.80
1.524 (60")	0.808	1.292	2.06	3.55	1.00	1.26	1.55	2.14	3.49	5.77	5.68	9.15	0.97
1.778 (70")	0.942	1.508	2.42	4.15	1.18	1.48	1.82	2.50	4.09	6.75	6.66	10.71	1.14
2.032 (80")	1.077	1.723	2.77	4.76	1.35	1.69	2.09	2.87	4.69	7.73	7.64	12.27	1.32
2.286 (90")	1.212	1.939	3.12	5.36	1.53	1.91	2.36	3.23	5.30	8.71	8.63	13.83	1.49
2.540 (100")	1.346	2.154	3.48	5.96	1.71	2.13	2.63	3.60	5.90	9.69	9.61	15.39	1.66
3.048 (120")	1.615	2.585	4.18	7.16	2.06	2.56	3.16	4.33	7.10	11.65	11.57	18.51	2.00
3.810 (150")	2.019	3.231	5.24	8.96	2.58	3.22	3.97	5.42	8.90	14.59	14.52	23.19	2.52
5.080 (200")	2.692	4.308	7.01	11.96	3.46	4.30	5.31	7.25	11.91	19.49	19.43	30.99	3.38
6.350 (250")	3.365	5.385	8.77	14.96	4.34	5.39	6.65	9.07	14.91	24.39	24.34	38.79	4.24
7.620 (300")	4.039	6.462	10.54	17.97	5.21	6.48	7.99	10.90	17.92	29.29	29.25	46.59	5.10
8.890 (350")	4.712	7.539	12.30	20.97	6.09	7.56	9.33	12.73	20.92	34.19	34.16	54.39	5.95
10.160 (400")	5.385	8.616	14.07	23.97	6.97	8.65	10.67	14.55	23.93	39.09	39.07	62.19	6.81

Projection lens Model No.			Standard zoom lens/ ET-ELS20/ET-ELW20/ ET-ELT20/ET-ELT21		ET-ELW22		ET-ELW21 (Fixed)	
Projected image size			Height position (H) <sup>*2</sup>					
Diagonal (SD)	Height (SH)	Width (SW)						
1.016 (40")	0.538	0.862	-0.09 - 0.63		—		0.27	
1.270 (50")	0.673	1.077	-0.11 - 0.79		—		0.34	
1.524 (60")	0.808	1.292	-0.14 - 0.95		-0.08 - 0.89		0.40	
1.778 (70")	0.942	1.508	-0.16 - 1.10		-0.09 - 1.04		0.47	
2.032 (80")	1.077	1.723	-0.18 - 1.26		-0.11 - 1.18		0.54	
2.286 (90")	1.212	1.939	-0.21 - 1.42		-0.12 - 1.33		0.61	
2.540 (100")	1.346	2.154	-0.23 - 1.58		-0.13 - 1.48		0.67	
3.048 (120")	1.615	2.585	-0.27 - 1.89		-0.16 - 1.78		0.81	
3.810 (150")	2.019	3.231	-0.34 - 2.36		-0.20 - 2.22		1.01	
5.080 (200")	2.692	4.308	-0.46 - 3.15		-0.27 - 2.96		1.35	
6.350 (250")	3.365	5.385	-0.57 - 3.94		-0.34 - 3.70		1.68	
7.620 (300")	4.039	6.462	-0.69 - 4.73		-0.40 - 4.44		2.02	
8.890 (350")	4.712	7.539	-0.80 - 5.51		-0.47 - 5.18		2.36	
10.160 (400")	5.385	8.616	-0.92 - 6.30		-0.54 - 5.92		2.69	

\*1 The throw ratio is based on the value during projection of 2.03 m (80") projected image size.

\*2 When the Fixed-focus Lens (Model No.: ET-ELW21) is attached, the lens shift is not possible, therefore the height position (H) becomes SH/2.



■ When the screen aspect ratio is 16:9

(Unit: m)

Lens type			Zoom Lens										Fixed-focus Lens
Projection lens Model No.			Standard zoom lens/ET-ELS20		ET-ELW22		ET-ELW20		ET-ELT20		ET-ELT21		ET-ELW21
Throw ratio*1			1.6-2.8:1		0.8-1.0:1		1.2-1.7:1		2.7-4.5:1		4.4-7.1:1		0.8:1
Projected image size			Projection distance (L)										
Diagonal (SD)	Height (SH)	Width (SW)	Min. (LW)	Max. (LT)	Min. (LW)	Max. (LT)	Min. (LW)	Max. (LT)	Min. (LW)	Max. (LT)	Min. (LW)	Max. (LT)	Fixed
1.016 (40")	0.498	0.886	1.40	2.42	—	—	1.05	1.45	2.36	3.92	3.83	6.20	0.65
1.270 (50")	0.623	1.107	1.76	3.04	—	—	1.32	1.82	2.97	4.92	4.83	7.81	0.83
1.524 (60")	0.747	1.328	2.12	3.65	1.03	1.30	1.60	2.20	3.59	5.93	5.84	9.41	1.00
1.778 (70")	0.872	1.550	2.49	4.27	1.21	1.52	1.87	2.57	4.21	6.94	6.85	11.01	1.18
2.032 (80")	0.996	1.771	2.85	4.89	1.39	1.74	2.15	2.95	4.83	7.95	7.86	12.62	1.35
2.286 (90")	1.121	1.992	3.21	5.51	1.57	1.97	2.43	3.32	5.45	8.95	8.87	14.22	1.53
2.540 (100")	1.245	2.214	3.57	6.12	1.75	2.19	2.70	3.70	6.06	9.96	9.88	15.82	1.71
3.048 (120")	1.494	2.657	4.30	7.36	2.11	2.64	3.25	4.45	7.30	11.97	11.90	19.03	2.06
3.810 (150")	1.868	3.321	5.39	9.21	2.66	3.31	4.08	5.58	9.15	15.00	14.93	23.84	2.59
5.080 (200")	2.491	4.428	7.20	12.29	3.56	4.42	5.46	7.45	12.24	20.03	19.98	31.86	3.47
6.350 (250")	3.113	5.535	9.02	15.38	4.46	5.54	6.83	9.33	15.33	25.07	25.02	39.87	4.36
7.620 (300")	3.736	6.641	10.83	18.47	5.36	6.66	8.21	11.20	18.42	30.10	30.07	47.89	5.24
8.890 (350")	4.358	7.748	12.65	21.55	6.26	7.77	9.59	13.08	21.51	35.14	35.12	55.91	6.12
10.160 (400")	4.981	8.855	14.46	24.64	7.16	8.89	10.97	14.96	24.60	40.18	40.17	63.92	7.00

Projection lens Model No.			Standard zoom lens/ ET-ELS20/ET-ELW20/ ET-ELT20/ET-ELT21		ET-ELW22		ET-ELW21 (Fixed)	
Projected image size			Height position (H)*2					
Diagonal (SD)	Height (SH)	Width (SW)						
1.016 (40")	0.498	0.886	-0.12 - 0.62		—		0.25	
1.270 (50")	0.623	1.107	-0.15 - 0.77		—		0.31	
1.524 (60")	0.747	1.328	-0.18 - 0.93		-0.12 - 0.87		0.37	
1.778 (70")	0.872	1.550	-0.21 - 1.08		-0.15 - 1.02		0.44	
2.032 (80")	0.996	1.771	-0.24 - 1.24		-0.17 - 1.16		0.50	
2.286 (90")	1.121	1.992	-0.27 - 1.39		-0.19 - 1.31		0.56	
2.540 (100")	1.245	2.214	-0.30 - 1.55		-0.21 - 1.45		0.62	
3.048 (120")	1.494	2.657	-0.37 - 1.86		-0.25 - 1.74		0.75	
3.810 (150")	1.868	3.321	-0.46 - 2.32		-0.31 - 2.18		0.93	
5.080 (200")	2.491	4.428	-0.61 - 3.10		-0.42 - 2.91		1.25	
6.350 (250")	3.113	5.535	-0.76 - 3.87		-0.52 - 3.63		1.56	
7.620 (300")	3.736	6.641	-0.91 - 4.65		-0.62 - 4.36		1.87	
8.890 (350")	4.358	7.748	-1.07 - 5.42		-0.73 - 5.08		2.18	
10.160 (400")	4.981	8.855	-1.22 - 6.20		-0.83 - 5.81		2.49	

\*1 The throw ratio is based on the value during projection of 2.03 m (80") projected image size.

\*2 When the Fixed-focus Lens (Model No.: ET-ELW21) is attached, the lens shift is not possible, therefore the height position (H) becomes SH/2.

■ When the screen aspect ratio is 4:3

(Unit: m)

Lens type			Zoom Lens										Fixed-focus Lens
Projection lens Model No.			Standard zoom lens/ET-ELS20		ET-ELW22		ET-ELW20		ET-ELT20		ET-ELT21		ET-ELW21
Throw ratio*1			1.9-3.3:1		0.9-1.2:1		1.5-2.0:1		3.3-5.4:1		5.3-8.6:1		0.9:1
Projected image size			Projection distance (L)										
Diagonal (SD)	Height (SH)	Width (SW)	Min. (LW)	Max. (LT)	Min. (LW)	Max. (LT)	Min. (LW)	Max. (LT)	Min. (LW)	Max. (LT)	Min. (LW)	Max. (LT)	Fixed
1.016 (40")	0.610	0.813	1.54	2.67	—	—	1.16	1.60	2.61	4.33	4.24	6.85	0.72
1.270 (50")	0.762	1.016	1.94	3.35	—	—	1.46	2.01	3.29	5.43	5.35	8.62	0.91
1.524 (60")	0.914	1.219	2.34	4.03	1.14	1.43	1.77	2.43	3.97	6.54	6.46	10.39	1.11
1.778 (70")	1.067	1.422	2.74	4.71	1.34	1.68	2.07	2.84	4.65	7.65	7.57	12.15	1.30
2.032 (80")	1.219	1.626	3.14	5.39	1.54	1.92	2.37	3.25	5.33	8.76	8.68	13.92	1.50
2.286 (90")	1.372	1.829	3.54	6.07	1.74	2.17	2.68	3.67	6.01	9.87	9.79	15.68	1.69
2.540 (100")	1.524	2.032	3.94	6.75	1.94	2.42	2.98	4.08	6.69	10.98	10.91	17.45	1.89
3.048 (120")	1.829	2.438	4.74	8.11	2.33	2.91	3.59	4.91	8.05	13.20	13.13	20.98	2.28
3.810 (150")	2.286	3.048	5.94	10.15	2.93	3.65	4.50	6.15	10.09	16.53	16.47	26.28	2.86
5.080 (200")	3.048	4.064	7.94	13.55	3.92	4.88	6.02	8.21	13.49	22.08	22.03	35.11	3.83
6.350 (250")	3.810	5.080	9.94	16.95	4.91	6.11	7.53	10.28	16.90	27.62	27.58	43.94	4.80
7.620 (300")	4.572	6.096	11.94	20.34	5.91	7.34	9.05	12.35	20.30	33.17	33.14	52.77	5.78
8.890 (350")	5.334	7.112	13.93	23.74	6.90	8.57	10.57	14.41	23.70	38.72	38.70	61.60	6.75
10.160 (400")	6.096	8.128	15.93	27.14	7.89	9.80	12.09	16.48	27.10	44.27	44.26	70.43	7.72

Projection lens Model No.			Standard zoom lens/ ET-ELS20/ET-ELW20/ ET-ELT20/ET-ELT21		ET-ELW22	ET-ELW21 (Fixed)
Projected image size			Height position (H)*2			
Diagonal (SD)	Height (SH)	Width (SW)				
1.016 (40")	0.610	0.813	-0.10 - 0.71		—	0.30
1.270 (50")	0.762	1.016	-0.13 - 0.89		—	0.38
1.524 (60")	0.914	1.219	-0.16 - 1.07		-0.09 - 1.01	0.46
1.778 (70")	1.067	1.422	-0.18 - 1.25		-0.11 - 1.17	0.53
2.032 (80")	1.219	1.626	-0.21 - 1.43		-0.12 - 1.34	0.61
2.286 (90")	1.372	1.829	-0.23 - 1.60		-0.14 - 1.51	0.69
2.540 (100")	1.524	2.032	-0.26 - 1.78		-0.15 - 1.68	0.76
3.048 (120")	1.829	2.438	-0.31 - 2.14		-0.18 - 2.01	0.91
3.810 (150")	2.286	3.048	-0.39 - 2.67		-0.23 - 2.51	1.14
5.080 (200")	3.048	4.064	-0.52 - 3.57		-0.30 - 3.35	1.52
6.350 (250")	3.810	5.080	-0.65 - 4.46		-0.38 - 4.19	1.91
7.620 (300")	4.572	6.096	-0.78 - 5.35		-0.46 - 5.03	2.29
8.890 (350")	5.334	7.112	-0.91 - 6.24		-0.53 - 5.87	2.67
10.160 (400")	6.096	8.128	-1.04 - 7.13		-0.61 - 6.71	3.05

\*1 The throw ratio is based on the value during projection of 2.03 m (80") projected image size.

\*2 When the Fixed-focus Lens (Model No.: ET-ELW21) is attached, the lens shift is not possible, therefore the height position (H) becomes SH/2.

PT-MW630, PT-MW530

■ When the screen aspect ratio is 16:10

(Unit: m)

Lens type			Zoom Lens										Fixed-focus Lens
Projection lens Model No.			Standard zoom lens/ET-ELS20		ET-ELW22		ET-ELW20		ET-ELT20		ET-ELT21		ET-ELW21
Throw ratio <sup>*1</sup>			1.6-2.8:1		0.8-1.0:1		1.2-1.7:1		2.8-4.5:1		4.5-7.2:1		0.8:1
Projected image size			Projection distance (L)										
Diagonal (SD)	Height (SH)	Width (SW)	Min. (LW)	Max. (LT)	Min. (LW)	Max. (LT)	Min. (LW)	Max. (LT)	Min. (LW)	Max. (LT)	Min. (LW)	Max. (LT)	Fixed
1.016 (40")	0.538	0.862	1.38	2.38	—	—	1.03	1.42	2.32	3.85	3.76	6.10	0.64
1.270 (50")	0.673	1.077	1.74	2.99	—	—	1.30	1.79	2.93	4.85	4.76	7.68	0.81
1.524 (60")	0.808	1.292	2.09	3.60	1.01	1.26	1.58	2.16	3.54	5.84	5.75	9.26	0.99
1.778 (70")	0.942	1.508	2.45	4.21	1.18	1.48	1.85	2.53	4.14	6.83	6.75	10.84	1.16
2.032 (80")	1.077	1.723	2.81	4.82	1.36	1.70	2.12	2.90	4.75	7.82	7.74	12.42	1.33
2.286 (90")	1.212	1.939	3.16	5.42	1.54	1.92	2.39	3.27	5.36	8.81	8.73	14.00	1.51
2.540 (100")	1.346	2.154	3.52	6.03	1.71	2.14	2.66	3.64	5.97	9.80	9.73	15.58	1.68
3.048 (120")	1.615	2.585	4.24	7.25	2.06	2.57	3.21	4.38	7.19	11.79	11.72	18.73	2.03
3.810 (150")	2.019	3.231	5.31	9.07	2.59	3.23	4.02	5.48	9.01	14.76	14.70	23.47	2.55
5.080 (200")	2.692	4.308	7.09	12.11	3.47	4.32	5.38	7.33	12.05	19.72	19.67	31.36	3.42
6.350 (250")	3.365	5.385	8.88	15.15	4.35	5.41	6.74	9.17	15.10	24.68	24.64	39.26	4.29
7.620 (300")	4.039	6.462	10.66	18.20	5.23	6.50	8.10	11.02	18.14	29.64	29.61	47.15	5.16
8.890 (350")	4.712	7.539	12.45	21.24	6.11	7.59	9.46	12.86	21.18	34.59	34.58	55.04	6.03
10.160 (400")	5.385	8.616	14.24	24.28	6.99	8.68	10.82	14.71	24.22	39.55	39.55	62.94	6.89

Projection lens Model No.			Standard zoom lens/ ET-ELS20/ET-ELW20/ ET-ELT20/ET-ELT21		ET-ELW22	ET-ELW21 (Fixed)
Projected image size			Height position (H) <sup>*2</sup>			
Diagonal (SD)	Height (SH)	Width (SW)				
1.016 (40")	0.538	0.862	-0.09 - 0.63		—	0.27
1.270 (50")	0.673	1.077	-0.11 - 0.79		—	0.34
1.524 (60")	0.808	1.292	-0.14 - 0.95		-0.08 - 0.89	0.40
1.778 (70")	0.942	1.508	-0.16 - 1.10		-0.09 - 1.04	0.47
2.032 (80")	1.077	1.723	-0.18 - 1.26		-0.11 - 1.18	0.54
2.286 (90")	1.212	1.939	-0.21 - 1.42		-0.12 - 1.33	0.61
2.540 (100")	1.346	2.154	-0.23 - 1.58		-0.13 - 1.48	0.67
3.048 (120")	1.615	2.585	-0.27 - 1.89		-0.16 - 1.78	0.81
3.810 (150")	2.019	3.231	-0.34 - 2.36		-0.20 - 2.22	1.01
5.080 (200")	2.692	4.308	-0.46 - 3.15		-0.27 - 2.96	1.35
6.350 (250")	3.365	5.385	-0.57 - 3.94		-0.34 - 3.70	1.68
7.620 (300")	4.039	6.462	-0.69 - 4.73		-0.40 - 4.44	2.02
8.890 (350")	4.712	7.539	-0.80 - 5.51		-0.47 - 5.18	2.36
10.160 (400")	5.385	8.616	-0.92 - 6.30		-0.54 - 5.92	2.69

\*1 The throw ratio is based on the value during projection of 2.03 m (80") projected image size.

\*2 When the Fixed-focus Lens (Model No.: ET-ELW21) is attached, the lens shift is not possible, therefore the height position (H) becomes SH/2.

■ When the screen aspect ratio is 16:9

(Unit: m)

Lens type			Zoom Lens										Fixed-focus Lens
Projection lens Model No.			Standard zoom lens/ET-ELS20		ET-ELW22		ET-ELW20		ET-ELT20		ET-ELT21		ET-ELW21
Throw ratio*1			1.6-2.8:1		0.8-1.0:1		1.2-1.7:1		2.8-4.5:1		4.5-7.2:1		0.8:1
Projected image size			Projection distance (L)										
Diagonal (SD)	Height (SH)	Width (SW)	Min. (LW)	Max. (LT)	Min. (LW)	Max. (LT)	Min. (LW)	Max. (LT)	Min. (LW)	Max. (LT)	Min. (LW)	Max. (LT)	Fixed
1.016 (40")	0.498	0.886	1.42	2.45	—	—	1.06	1.46	2.39	3.96	3.87	6.28	0.66
1.270 (50")	0.623	1.107	1.79	3.08	—	—	1.34	1.84	3.01	4.98	4.90	7.90	0.84
1.524 (60")	0.747	1.328	2.15	3.70	1.04	1.30	1.62	2.22	3.64	6.00	5.92	9.52	1.01
1.778 (70")	0.872	1.550	2.52	4.33	1.22	1.52	1.90	2.60	4.26	7.02	6.94	11.15	1.19
2.032 (80")	0.996	1.771	2.89	4.95	1.40	1.75	2.18	2.98	4.89	8.04	7.96	12.77	1.37
2.286 (90")	1.121	1.992	3.25	5.58	1.58	1.97	2.46	3.36	5.51	9.06	8.98	14.39	1.55
2.540 (100")	1.245	2.214	3.62	6.20	1.76	2.20	2.74	3.74	6.14	10.08	10.00	16.01	1.73
3.048 (120")	1.494	2.657	4.35	7.45	2.12	2.65	3.30	4.50	7.39	12.12	12.05	19.26	2.09
3.810 (150")	1.868	3.321	5.46	9.33	2.67	3.32	4.14	5.64	9.27	15.18	15.11	24.13	2.62
5.080 (200")	2.491	4.428	7.29	12.45	3.57	4.44	5.53	7.53	12.39	20.27	20.22	32.24	3.52
6.350 (250")	3.113	5.535	9.13	15.58	4.47	5.56	6.93	9.43	15.52	25.37	25.33	40.35	4.41
7.620 (300")	3.736	6.641	10.96	18.70	5.38	6.68	8.33	11.33	18.64	30.46	30.44	48.47	5.30
8.890 (350")	4.358	7.748	12.80	21.83	6.28	7.80	9.72	13.22	21.77	35.56	35.55	56.58	6.19
10.160 (400")	4.981	8.855	14.63	24.95	7.19	8.93	11.12	15.12	24.90	40.66	40.66	64.69	7.09

Projection lens Model No.			Standard zoom lens/ ET-ELS20/ET-ELW20/ ET-ELT20/ET-ELT21		ET-ELW22	ET-ELW21 (Fixed)
Projected image size			Height position (H)*2			
Diagonal (SD)	Height (SH)	Width (SW)				
1.016 (40")	0.498	0.886	-0.12 - 0.62		—	0.25
1.270 (50")	0.623	1.107	-0.15 - 0.77		—	0.31
1.524 (60")	0.747	1.328	-0.18 - 0.93		-0.12 - 0.87	0.37
1.778 (70")	0.872	1.550	-0.21 - 1.08		-0.15 - 1.02	0.44
2.032 (80")	0.996	1.771	-0.24 - 1.24		-0.17 - 1.16	0.50
2.286 (90")	1.121	1.992	-0.27 - 1.39		-0.19 - 1.31	0.56
2.540 (100")	1.245	2.214	-0.30 - 1.55		-0.21 - 1.45	0.62
3.048 (120")	1.494	2.657	-0.37 - 1.86		-0.25 - 1.74	0.75
3.810 (150")	1.868	3.321	-0.46 - 2.32		-0.31 - 2.18	0.93
5.080 (200")	2.491	4.428	-0.61 - 3.10		-0.42 - 2.91	1.25
6.350 (250")	3.113	5.535	-0.76 - 3.87		-0.52 - 3.63	1.56
7.620 (300")	3.736	6.641	-0.91 - 4.65		-0.62 - 4.36	1.87
8.890 (350")	4.358	7.748	-1.07 - 5.42		-0.73 - 5.08	2.18
10.160 (400")	4.981	8.855	-1.22 - 6.20		-0.83 - 5.81	2.49

\*1 The throw ratio is based on the value during projection of 2.03 m (80") projected image size.

\*2 When the Fixed-focus Lens (Model No.: ET-ELW21) is attached, the lens shift is not possible, therefore the height position (H) becomes SH/2.

■ When the screen aspect ratio is 4:3

(Unit: m)

Lens type			Zoom Lens										Fixed-focus Lens
Projection lens Model No.			Standard zoom lens/ET-ELS20		ET-ELW22		ET-ELW20		ET-ELT20		ET-ELT21		ET-ELW21
Throw ratio*1			2.0-3.4:1		1.0-1.2:1		1.5-2.0:1		3.3-5.5:1		5.4-8.7:1		0.9:1
Projected image size			Projection distance (L)										
Diagonal (SD)	Height (SH)	Width (SW)	Min. (LW)	Max. (LT)	Min. (LW)	Max. (LT)	Min. (LW)	Max. (LT)	Min. (LW)	Max. (LT)	Min. (LW)	Max. (LT)	Fixed
1.016 (40")	0.610	0.813	1.57	2.70	—	—	1.18	1.62	2.64	4.38	4.29	6.94	0.73
1.270 (50")	0.762	1.016	1.97	3.39	—	—	1.48	2.04	3.33	5.50	5.41	8.73	0.93
1.524 (60")	0.914	1.219	2.38	4.08	1.15	1.44	1.79	2.45	4.02	6.62	6.54	10.51	1.12
1.778 (70")	1.067	1.422	2.78	4.77	1.35	1.68	2.10	2.87	4.71	7.75	7.67	12.30	1.32
2.032 (80")	1.219	1.626	3.18	5.46	1.55	1.93	2.41	3.29	5.40	8.87	8.79	14.09	1.52
2.286 (90")	1.372	1.829	3.59	6.15	1.75	2.18	2.71	3.71	6.08	9.99	9.92	15.87	1.71
2.540 (100")	1.524	2.032	3.99	6.84	1.94	2.42	3.02	4.12	6.77	11.11	11.04	17.66	1.91
3.048 (120")	1.829	2.438	4.80	8.21	2.34	2.92	3.64	4.96	8.15	13.36	13.29	21.24	2.30
3.810 (150")	2.286	3.048	6.01	10.28	2.94	3.66	4.56	6.21	10.22	16.73	16.67	26.60	2.89
5.080 (200")	3.048	4.064	8.04	13.72	3.94	4.90	6.10	8.30	13.66	22.34	22.30	35.53	3.88
6.350 (250")	3.810	5.080	10.06	17.16	4.93	6.13	7.64	10.39	17.10	27.95	27.92	44.47	4.86
7.620 (300")	4.572	6.096	12.08	20.61	5.93	7.37	9.18	12.48	20.55	33.57	33.55	53.40	5.85
8.890 (350")	5.334	7.112	14.10	24.05	6.93	8.60	10.72	14.57	23.99	39.18	39.18	62.34	6.83
10.160 (400")	6.096	8.128	16.12	27.49	7.92	9.84	12.25	16.66	27.43	44.79	44.80	71.28	7.81

Projection lens Model No.			Standard zoom lens/ ET-ELS20/ET-ELW20/ ET-ELT20/ET-ELT21		ET-ELW22	ET-ELW21 (Fixed)
Projected image size			Height position (H)*2			
Diagonal (SD)	Height (SH)	Width (SW)				
1.016 (40")	0.610	0.813	-0.10 - 0.71		—	0.30
1.270 (50")	0.762	1.016	-0.13 - 0.89		—	0.38
1.524 (60")	0.914	1.219	-0.16 - 1.07		-0.09 - 1.01	0.46
1.778 (70")	1.067	1.422	-0.18 - 1.25		-0.11 - 1.17	0.53
2.032 (80")	1.219	1.626	-0.21 - 1.43		-0.12 - 1.34	0.61
2.286 (90")	1.372	1.829	-0.23 - 1.60		-0.14 - 1.51	0.69
2.540 (100")	1.524	2.032	-0.26 - 1.78		-0.15 - 1.68	0.76
3.048 (120")	1.829	2.438	-0.31 - 2.14		-0.18 - 2.01	0.91
3.810 (150")	2.286	3.048	-0.39 - 2.67		-0.23 - 2.51	1.14
5.080 (200")	3.048	4.064	-0.52 - 3.57		-0.30 - 3.35	1.52
6.350 (250")	3.810	5.080	-0.65 - 4.46		-0.38 - 4.19	1.91
7.620 (300")	4.572	6.096	-0.78 - 5.35		-0.46 - 5.03	2.29
8.890 (350")	5.334	7.112	-0.91 - 6.24		-0.53 - 5.87	2.67
10.160 (400")	6.096	8.128	-1.04 - 7.13		-0.61 - 6.71	3.05

\*1 The throw ratio is based on the value during projection of 2.03 m (80") projected image size.

\*2 When the Fixed-focus Lens (Model No.: ET-ELW21) is attached, the lens shift is not possible, therefore the height position (H) becomes SH/2.

**Formula for calculating the projection distance per projection lens**

To use a projected image size not listed in this manual, check the projected image size SD (m) and use the respective formula to calculate projection distance.

All the units for the formula are m. (Value obtained by the following calculation formula contains a slight error.)

When calculating a projection distance using image size designation (value in inches), multiply the value in inches by 0.0254 and substitute it into SD in the formula for calculating the projection distance.

**PT-MZ670, PT-MZ570**

■ **Zoom Lens**

Projection lens Model No.	Throw ratio	Aspect ratio	Projection distance (L) formula	
			Min. (LW)	Max. (LT)
Standard zoom lens/ET-ELS20	1.6 - 2.8:1	16:10	= 1.389961 x SD – 0.054882	= 2.363976 x SD – 0.048228
	1.6 - 2.8:1	16:9	= 1.428602 x SD – 0.054882	= 2.429695 x SD – 0.048228
	1.9 - 3.3:1	4:3	= 1.573583 x SD – 0.054882	= 2.676260 x SD – 0.048228
ET-ELW22	0.8 - 1.0:1	16:10	= 0.690394 x SD – 0.048460	= 0.855787 x SD – 0.045477
	0.8 - 1.0:1	16:9	= 0.709587 x SD – 0.048460	= 0.879578 x SD – 0.045477
	0.9 - 1.2:1	4:3	= 0.781595 x SD – 0.048460	= 0.968837 x SD – 0.045477
ET-ELW20	1.2 - 1.7:1	16:10	= 1.055748 x SD – 0.055497	= 1.437441 x SD – 0.053400
	1.2 - 1.7:1	16:9	= 1.085098 x SD – 0.055497	= 1.477402 x SD – 0.053400
	1.5 - 2.0:1	4:3	= 1.195197 x SD – 0.055497	= 1.627323 x SD – 0.053400
ET-ELT20	2.7 - 4.5:1	16:10	= 2.366220 x SD – 0.114022	= 3.858307 x SD – 0.112874
	2.7 - 4.5:1	16:9	= 2.432001 x SD – 0.114022	= 3.965568 x SD – 0.112874
	3.3 - 5.4:1	4:3	= 1.195197 x SD – 0.055497	= 1.627323 x SD – 0.053400
ET-ELT21	4.4 - 7.1:1	16:10	= 3.866693 x SD – 0.212284	= 6.141575 x SD – 0.210772
	4.4 - 7.1:1	16:9	= 3.974187 x SD – 0.212284	= 6.312311 x SD – 0.210772
	5.3 - 8.6:1	4:3	= 4.377480 x SD – 0.212284	= 6.952874 x SD – 0.210772

■ **Fixed-focus Lens (Model No.: ET-ELW21)**

Projection lens Model No.	Throw ratio	Aspect ratio	Projection distance (L) formula
ET-ELW21	0.8:1	16:10	= 0.676299 x SD – 0.057678
	0.8:1	16:9	= 0.695100 x SD – 0.057678
	0.9:1	4:3	= 0.765630 x SD – 0.057678

**PT-MW630, PT-MW530**

■ **Zoom Lens**

Projection lens Model No.	Throw ratio	Aspect ratio	Projection distance (L) formula	
			Min. (LW)	Max. (LT)
Standard zoom lens/ET-ELS20	1.6 - 2.8:1	16:10	= 1.406181 x SD – 0.050400	= 2.394370 x SD – 0.049700
	1.6 - 2.8:1	16:9	= 1.445236 x SD – 0.050400	= 2.460945 x SD – 0.049700
	2.0 - 3.4:1	4:3	= 1.591906 x SD – 0.050400	= 2.710613 x SD – 0.049700
ET-ELW22	0.8 - 1.0:1	16:10	= 0.693071 x SD – 0.048417	= 0.859134 x SD – 0.045448
	0.8 - 1.0:1	16:9	= 0.712338 x SD – 0.048417	= 0.883018 x SD – 0.045448
	1.0 - 1.2:1	4:3	= 0.784610 x SD – 0.048417	= 0.972607 x SD – 0.045448
ET-ELW20	1.2 - 1.7:1	16:10	= 1.070236 x SD – 0.055400	= 1.453031 x SD – 0.053400
	1.2 - 1.7:1	16:9	= 1.099996 x SD – 0.055400	= 1.493425 x SD – 0.053400
	1.5 - 2.0:1	4:3	= 1.211591 x SD – 0.055400	= 1.644945 x SD – 0.053400
ET-ELT20	2.8 - 4.5:1	16:10	= 2.395157 x SD – 0.113900	= 3.904055 x SD – 0.112800
	2.8 - 4.5:1	16:9	= 2.461732 x SD – 0.113900	= 4.012598 x SD – 0.112800
	3.3 - 5.5:1	4:3	= 2.711504 x SD – 0.113900	= 4.419694 x SD – 0.112800
ET-ELT21	4.5 - 7.2:1	16:10	= 3.913819 x SD – 0.212700	= 6.215236 x SD – 0.210700
	4.5 - 7.2:1	16:9	= 4.022638 x SD – 0.212700	= 6.388031 x SD – 0.210700
	5.4 - 8.7:1	4:3	= 4.430747 x SD – 0.212700	= 7.036131 x SD – 0.210700

■ Fixed-focus Lens (Model No.: ET-ELW21)

Projection lens Model No.	Throw ratio	Aspect ratio	Projection distance (L) formula
ET-ELW21	0.8:1	16:10	= 0.684213 x SD - 0.057231
	0.8:1	16:9	= 0.703228 x SD - 0.057231
	0.9:1	4:3	= 0.774582 x SD - 0.057231

**Adjusting adjustable feet**

Install the projector on a flat surface so that the front of the projector is parallel to the screen surface and the projection screen is rectangular.

If the screen is tilted downward, extend the front adjustable feet so that the projected image becomes rectangular. The adjustable feet can also be used to adjust the projector to be level when it is tilted in the horizontal direction.

Adjustable feet can be extended by turning them as shown in the figure. Turning them in the opposite direction will return them to the original position.

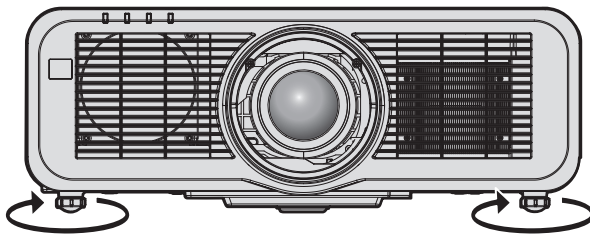

**Maximum adjustable range**

Adjustable feet: 23 mm (29/32") each

**Attention**

- Be careful not to block the intake/exhaust ports with your hands or any objects when adjusting the adjustable feet while the light source is on. (➔ page 30)

## Removing/attaching the projection lens

Removing and attaching methods of the projection lens are same for both standard zoom lenses and optional lenses.

Move the lens position to the home position before replacing or removing the projection lens. (➔ page 68)

### Attention

- Replace the projection lens after turning off the projector.
- Do not touch the electric contacts of the projection lens. Dust or dirt may cause poor contact.
- Do not touch the surface of the projection lens with your bare hands.
- Before attaching the projection lens, remove the lens cover attached to the projection lens.
- Before attaching the projection lens, remove the lens hole cover (only model with the lens sold separately) and the lens cover attached to the projection lens.
- Panasonic takes no responsibility for any damage or malfunction of the product resulting from the use of projection lenses which are not manufactured by Panasonic. Always use the standard zoom lens supplied with the projector or the specified projection lens.

### Removing the projection lens

Remove the projection lens using the following procedure.

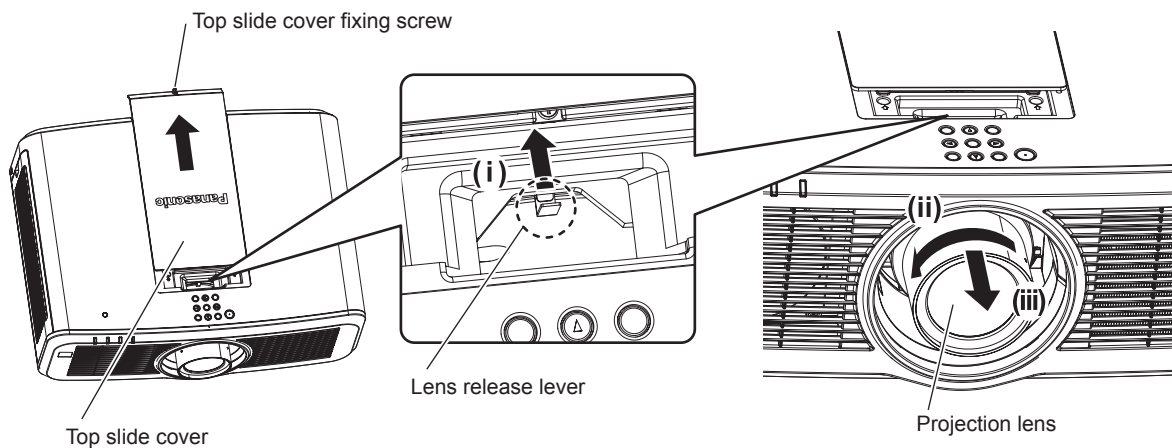

Fig. 1

Fig. 2

**1) Slide the top slide cover. (Fig. 1)**

- Turn the top slide cover fixing screw (x 1) counterclockwise until it turns freely using a Philips screwdriver, and slowly slide the top slide cover.

**2) While pressing the lens release lever, turn the projection lens counterclockwise to the end, and remove the projection lens. (Fig. 2)**

### Attention

- Store the removed projection lens where it will be free from vibration and impact.



## Attaching the projection lens

Attach the projection lens using the following procedure.

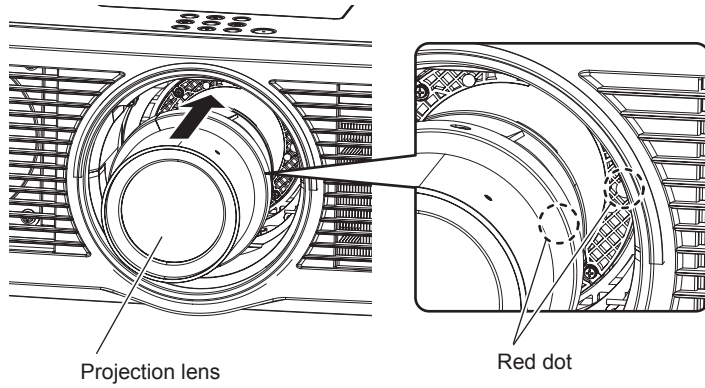

Fig. 1

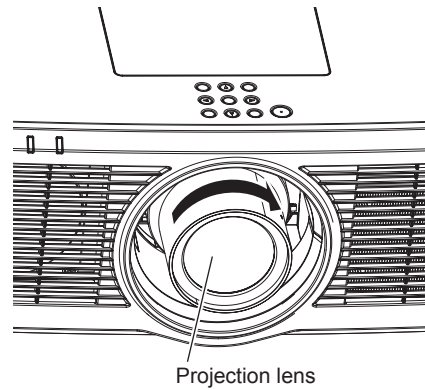

Fig. 2

- 1) Align the mark (red dot) on the projection lens with the mark (red dot) on the projector, and insert it all the way in. (Fig. 1)
- 2) Turn the projection lens clockwise to the end. (Fig. 2)

### Attention

- Turn the projection lens counterclockwise to confirm that it does not come out.

# Attaching the Wireless Module

To use the wireless LAN function with the projector, it is necessary to attach the optional Wireless Module (Model No.: ET-WM300).



## Attaching the Wireless Module

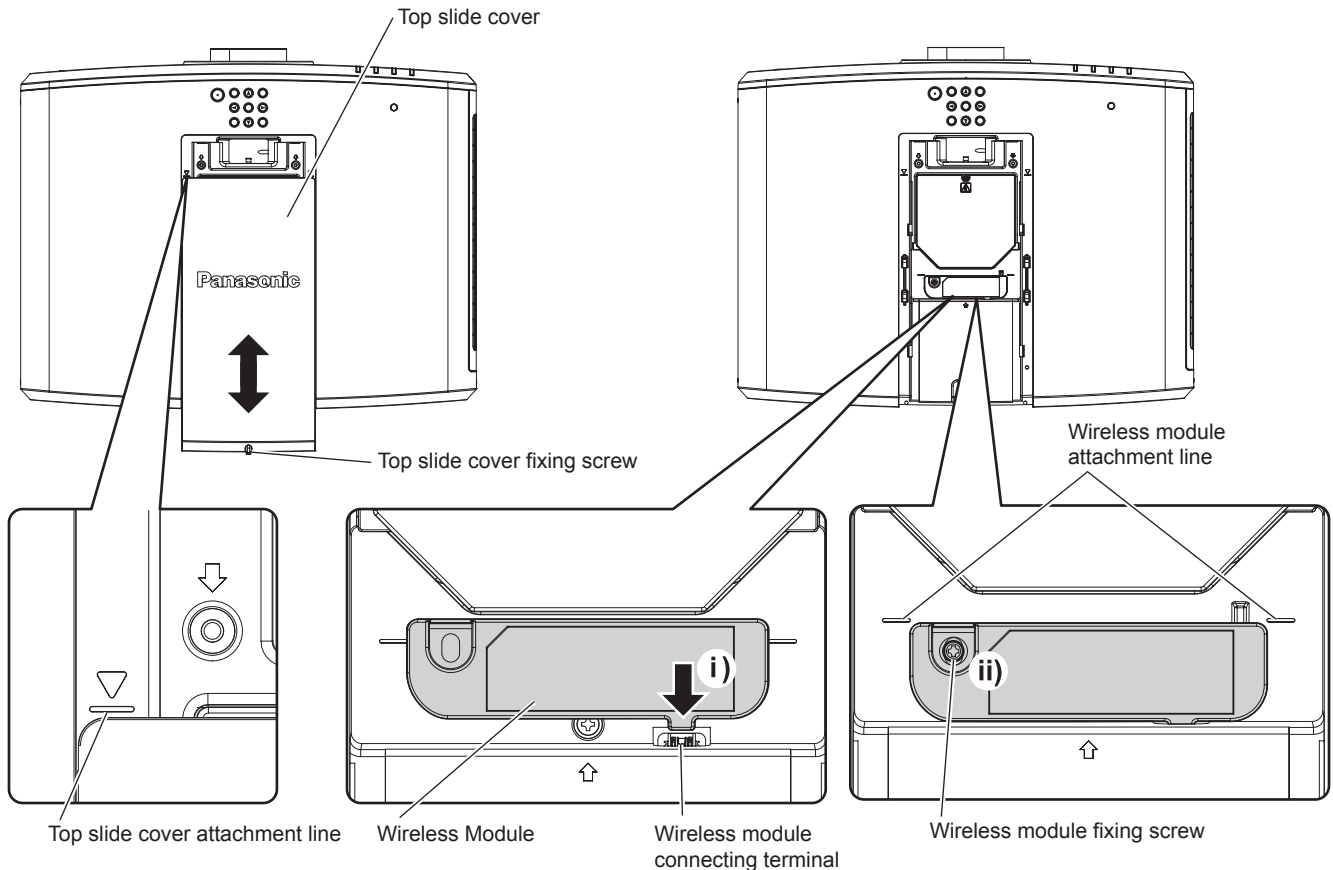

Fig. 1

Fig. 2

- 1) **Turn off the power of the projector.**
  - Always follow the procedure of “Switching off the projector” (➔ page 65) when turning off the power.
- 2) **Remove the top slide cover. (Fig. 1)**
  - Turn the top slide cover fixing screw (x 1) counterclockwise until it turns freely using a Philipps screwdriver, slide the top slide cover until the top slide cover attachment line is visible, and remove it.
- 3) **Attach the Wireless Module. (Fig. 2)**
  - i) Insert the Wireless Module into the wireless module connection terminal of the projector.
  - ii) Confirm that the edge of the Wireless Module is aligned to the wireless module attachment line, and securely fix the Wireless Module with the fixing screw (x 1) supplied with the Wireless Module.
- 4) **Attach the top slide cover. (Fig. 1)**
  - Align the top slide cover to the top slide cover attachment line, and attach it by sliding.
  - Securely tighten the top slide cover fixing screw (x 1) using a Phillipps screwdriver.

### Attention

- When tightening the screws, use a Phillipps screwdriver or similar, and do not use power screwdriver or impact screwdriver.
- Do not attach any USB device other than the optional Wireless Module (Model No.: ET-WM300).

# Connecting

## Before connecting

- Before connecting, carefully read the operating instructions for the external device to be connected.
- Turn off the power of all devices before connecting cables.
- Take note of the following points before connecting the cables. Failure to do so may result in malfunctions.
  - When connecting a cable to a device connected to the projector or the projector itself, touch any nearby metallic objects to eliminate static electricity from your body before performing work.
  - Do not use unnecessarily long cables to connect a device to the projector or to the projector body. The longer the cable, the more susceptible to noise it becomes. Since using a cable while it is wound makes it act like an antenna, it is more susceptible to noise.
  - When connecting cables, connect GND first, then insert the connecting terminal of the connecting device in a straight manner.
- Acquire any connection cable necessary to connect the external device to the system that is neither supplied with the device nor available as an option.
- If video signals from video equipment contain too much jitter, the images on the screen may wobble. In this case, a time base corrector (TBC) must be connected.
- If synchronization signals output from computers or video equipment are disrupted due to changes in the video output setting or other reasons, colors of projected images may be temporarily disrupted.
- The signal that can be connected to the projector is video signal, YC<sub>B</sub>C<sub>R</sub>/YP<sub>B</sub>P<sub>R</sub> signal, analog RGB signal (synchronization signal is TTL level), and digital signal.
- Some computer models or graphic cards are not compatible with the projector.
- Use a cable compensator when you connect devices to the projector using long cables. Otherwise the projector may not project the image properly.
- For details of the types of video signals that can be used with the projector, refer to “List of compatible signals” (➔ page 217).

## <RGB 2 IN> terminal pin assignment and signal name

Outside view	Pin No.	Signal name	Pin No.	Signal name
	(1)	R/P <sub>R</sub>	(9)	+5 V
	(2)	G/Y	(10)	GND
	(3)	B/P <sub>B</sub>	(11)	GND
	(4)	—	(12)	DDC data
	(5)	GND	(13)	SYNC/HD
	(6)	GND	(14)	VD
	(7)	GND	(15)	DDC clock
	(8)	GND		

## <MONITOR OUT> terminal pin assignment and signal name

Outside view	Pin No.	Signal name	Pin No.	Signal name
	(1)	R/P <sub>R</sub>	(9)	—
	(2)	G/Y	(10)	GND
	(3)	B/P <sub>B</sub>	(11)	GND
	(4)	—	(12)	—
	(5)	GND	(13)	SYNC/HD
	(6)	GND	(14)	VD
	(7)	GND	(15)	—
	(8)	GND		

<HDMI 1 IN> terminal/<HDMI 2 IN> terminal pin assignments and signal names

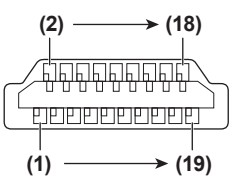
Outside view	Pin No.	Signal name	Pin No.	Signal name
<p>Even-numbered pins of (2) to (18)</p>  <p>Odd-numbered pins of (1) to (19)</p>	(1)	T.M.D.S data 2+	(11)	T.M.D.S clock shield
	(2)	T.M.D.S data 2 shield	(12)	T.M.D.S clock-
	(3)	T.M.D.S data 2-	(13)	CEC
	(4)	T.M.D.S data 1+	(14)	—
	(5)	T.M.D.S data 1 shield	(15)	SCL
	(6)	T.M.D.S data 1-	(16)	SDA
	(7)	T.M.D.S data 0+	(17)	DDC/CEC GND
	(8)	T.M.D.S data 0 shield	(18)	+5 V
	(9)	T.M.D.S data 0-	(19)	Hot plug detection
	(10)	T.M.D.S clock+		

Connecting example: AV equipment

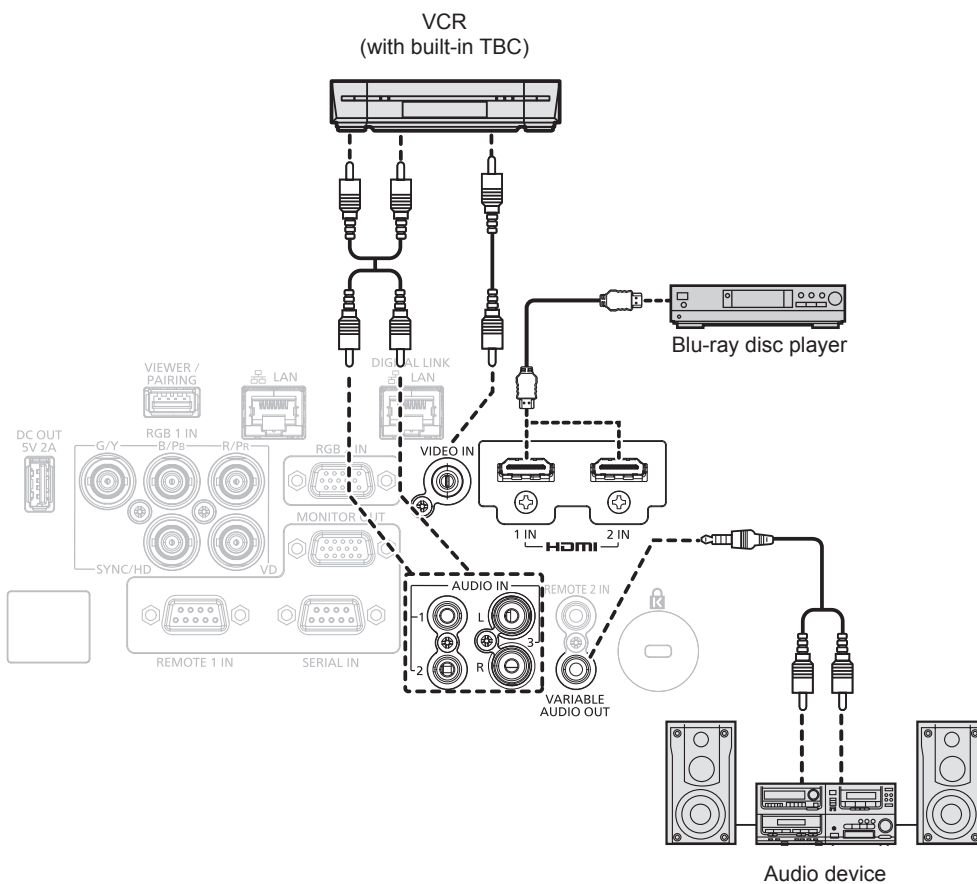

Attention

- Be sure to use one of the following when connecting a VCR.
  - Use a VCR with built-in time base corrector (TBC).
  - Use a time base corrector (TBC) between the projector and the VCR.
- The image may be disrupted when nonstandard burst signal is connected. In such a case, connect the time base corrector (TBC) between the projector and the external devices.

Note

- For the HDMI cable, use an HDMI High Speed cable that conforms to the HDMI standards. If a cable that does not conform to the HDMI standards is used, images may be interrupted or may not be projected.
- The <HDMI 1 IN>/<HDMI 2 IN> terminals can be connected to an external device with the DVI-D terminal by using an HDMI/DVI conversion cable. However, this may not function properly for some external devices, and image may not be projected.
- The projector does not support VIERA Link (HDMI).

## Connecting example: Computers

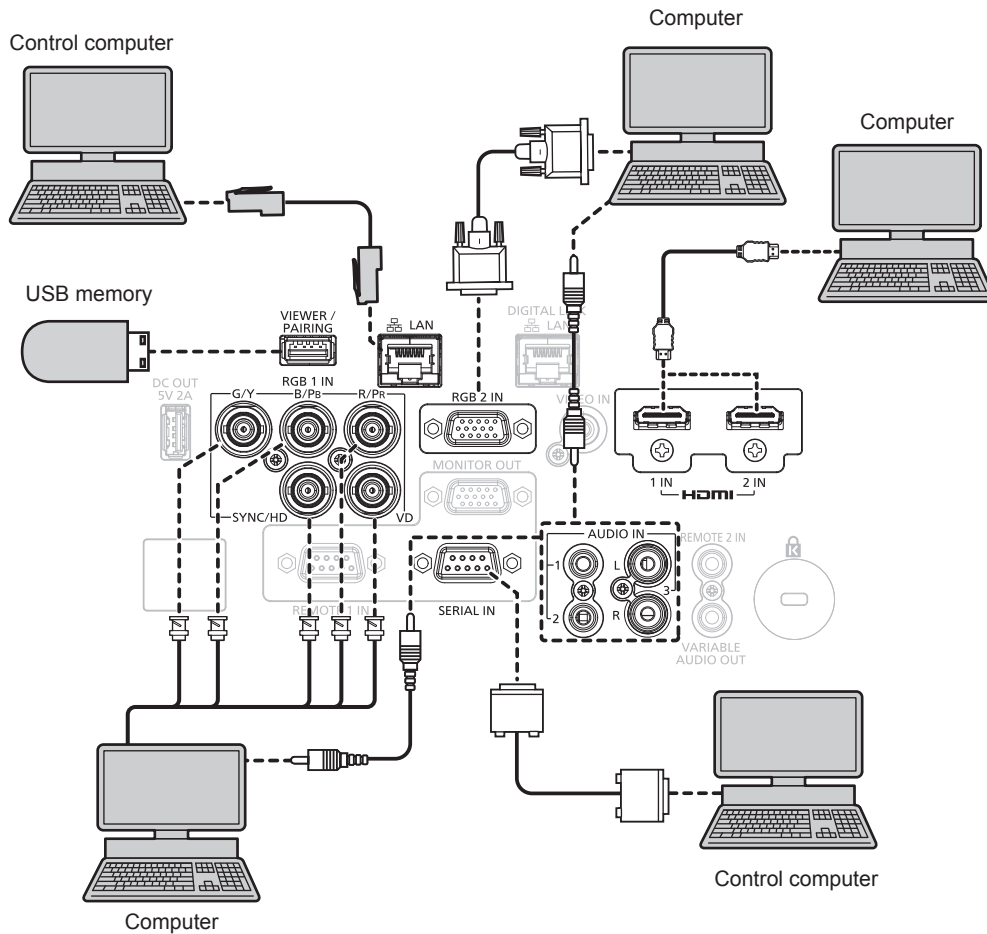

### Attention

- When connecting the projector to a computer or an external device, use the power cord supplied with each device and commercially available shielded cables.

### Note

- For the HDMI cable, use an HDMI High Speed cable that conforms to the HDMI standards. If a cable that does not conform to the HDMI standards is used, images may be interrupted or may not be projected.
- The <HDMI 1 IN>/<HDMI 2 IN> terminals can be connected to an external device with the DVI-D terminal by using an HDMI/DVI conversion cable. However, this may not function properly for some external devices, and image may not be projected.
- If you operate the projector using the computer with the resume feature (last memory), you may have to reset the resume feature to operate the projector.

## Connecting example using DIGITAL LINK

Twisted-pair-cable transmitter based on the communication standard HDBaseT™ such as the optional DIGITAL LINK output supported device (Model No.: ET-YFB100G, ET-YFB200G) uses the twisted pair cable to transmit input images, audio, Ethernet, and serial control signal, and the projector can input such digital signal to the <DIGITAL LINK/LAN> terminal.

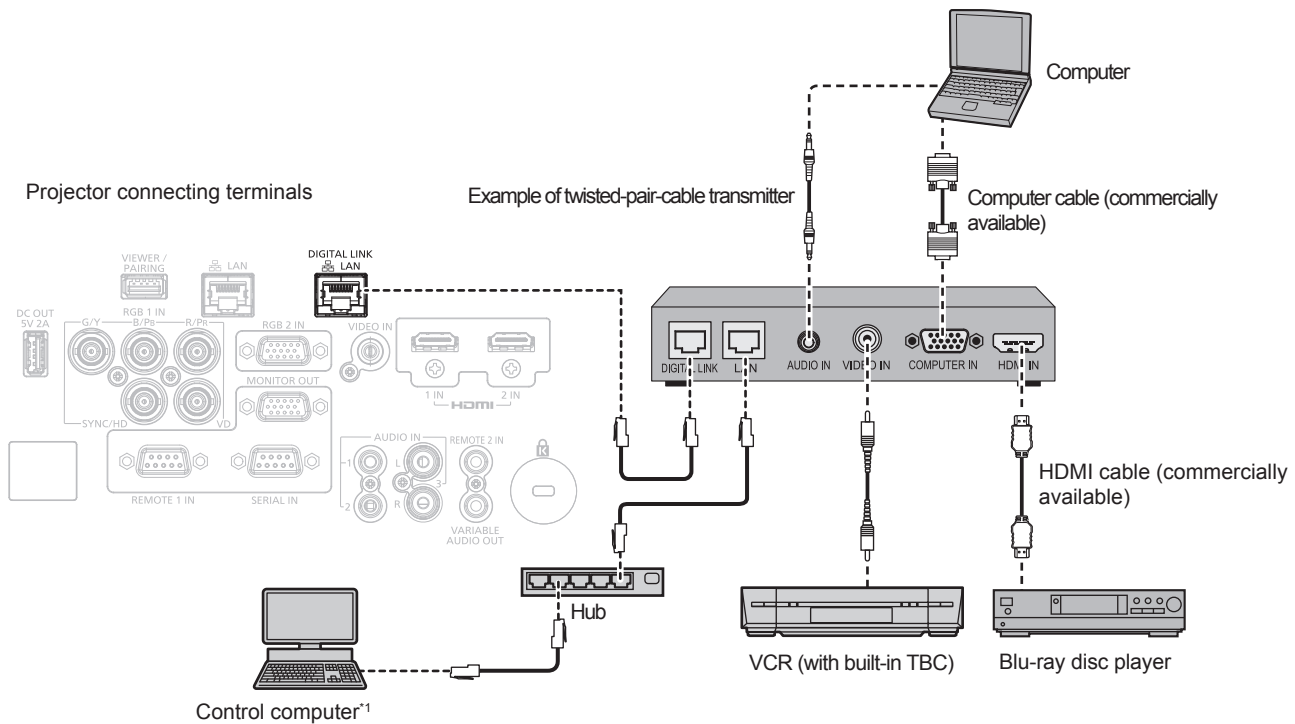

\*1 Control target is the projector or the twisted-pair-cable transmitter. The control itself may not be possible depending on the twisted-pair-cable transmitter. Check the operating instructions of the device to be connected.

### Attention

- Always use one of the following when connecting a VCR.
  - Use a VCR with built-in time base corrector (TBC).
  - Use a time base corrector (TBC) between the projector and the VCR.
- The image may be disrupted when nonstandard burst signal is connected. In such a case, connect the time base corrector (TBC) between the projector and the external devices.
- Ask a qualified technician or your dealer to install the cable wiring between the twisted-pair-cable transmitter and the projector. Image may be disrupted if cable transmission characteristics cannot be obtained due to inadequate installation.
- For the LAN cable between the twisted-pair-cable transmitter and the projector, use a cable that meets the following criteria:
  - Conforming to CAT5e or higher standards
  - Shielded type (including connectors)
  - Straight-through
  - Single wire
- When laying cables between the twisted-pair-cable transmitter and the projector, confirm that cable characteristics are compatible with CAT5e or higher using tools such as a cable tester or cable analyzer. When a relay connector is used, include it in the measurement.
- Do not use a hub between the twisted-pair-cable transmitter and the projector.
- When connecting to the projector using a twisted-pair-cable transmitter (receiver) of other manufacturers, do not place another twisted-pair-cable transmitter between the twisted-pair-cable transmitter of other manufacturers and the projector. This may cause image to be disrupted.
- Do not pull cables forcefully. Also, do not bend or fold cables unnecessarily.
- To reduce the effects of noise as much as possible, stretch out the cables between the twisted-pair-cable transmitter and the projector without any loops.
- Lay the cables between the twisted-pair-cable transmitter and the projector away from other cables, particularly power cables.
- When laying multiple cables, run them side by side along the shortest distance possible without bundling them together.
- After laying the cable, confirm that the value of [SIGNAL QUALITY] in the [NETWORK/USB] menu → [DIGITAL LINK STATUS] is displayed in green, which indicates a normal quality. (▶ page 139)

### Note

---

---

- For the HDMI cable, use an HDMI High Speed cable that conforms to the HDMI standards. If a cable that does not conform to the HDMI standards is used, images may be interrupted or may not be projected.
- The projector does not support VIERA Link (HDMI).
- The maximum transmission distance between the twisted-pair-cable transmitter and the projector is 100 m (328'1"). It is possible to transmit up to 150 m (492'2") if the twisted-pair-cable transmitter supports the long-reach communication method. If this distance is exceeded, image may be disrupted or a malfunction may occur in LAN communication. Please note that Panasonic does not support the use of the projector outside the maximum transmission distance. When connecting with the long reach, video signal or distance that can be transmitted may be restricted, depending on the specification of the twisted-pair-cable transmitter.
- For twisted-pair-cable transmitters of other manufacturers that the operation has been verified with this projector, visit the Panasonic website (<https://panasonic.net/cns/projector/>). Note that the verification for devices of other manufacturers has been made for the items set by Panasonic Corporation, and not all the operations have been verified. For operation or performance problems caused by the devices of other manufacturers, contact the respective manufacturers.

# Chapter 3 Basic Operations

---

This chapter describes basic operations to start with.



# Switching on/off the projector

## Connecting the power cord

Make sure that the supplied power cord is securely fixed to the projector body to prevent it from being removed easily.

Confirm that the <MAIN POWER> switch is on the <OFF> side before connecting the supplied power cord to the projector.

Use the power cord matching with the power supply voltage and the shape of the outlet.

For details of power cord handling, refer to “Read this first!” (➡ page 5).

## How to attach the power cord

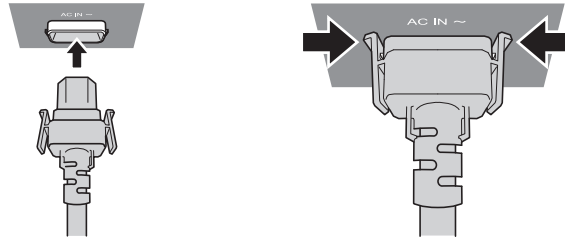

- 1) Check the shapes of the <AC IN> terminal at the rear of the projector and the power cord connector, and insert the connector completely in the correct direction (until you hear the side tabs click in place).

## How to remove the power cord

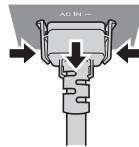

- 1) Confirm that the <MAIN POWER> switch at the rear of the projector is set to <OFF> side, and remove the power plug from the outlet.
- 2) Remove the power cord connector from the <AC IN> terminal of the projector while pressing the side tabs.

## Power indicator

Indicate the status of the power. Check the status of the power indicator <ON (G)/STANDBY (R)> before operating the projector.

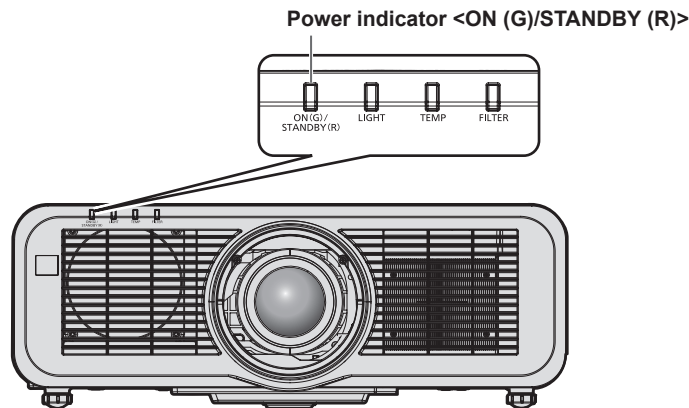

Indicator status		Projector status
Off		The main power is switched off.
Red	Lit	<p>The power is switched off. (standby mode) Projection will start when the power &lt;⏻/⏷&gt; button is pressed.</p> <ul style="list-style-type: none"> <li>The setting of the projector is as follows. <ul style="list-style-type: none"> <li>The [PROJECTOR SETUP] menu → [ECO MANAGEMENT] → [QUICK STARTUP] is set to [OFF]</li> <li>The [PROJECTOR SETUP] menu → [AUDIO SETTING] → [IN STANDBY MODE] is set to [OFF]</li> </ul> </li> <li>The projector may not operate when the light source indicator &lt;LIGHT&gt; or the temperature indicator &lt;TEMP&gt; is blinking. (➡ page 196)</li> </ul>
	Blinking	<p>The power is switched off. (standby mode) Projection will start when the power &lt;⏻/⏷&gt; button is pressed.</p> <ul style="list-style-type: none"> <li>The projector is set to one of the following. Power consumption is high. <ul style="list-style-type: none"> <li>The [PROJECTOR SETUP] menu → [ECO MANAGEMENT] → [QUICK STARTUP] is set to [ON]</li> <li>The [PROJECTOR SETUP] menu → [AUDIO SETTING] → [IN STANDBY MODE] is set to [ON]</li> </ul> </li> <li>The indicator will change to a red light when the specified time has elapsed after the projector enters the standby mode if the projector is set as following. The specified time is a time set in the [PROJECTOR SETUP] menu → [ECO MANAGEMENT] → [QUICK STARTUP] → [VALID PERIOD]. <ul style="list-style-type: none"> <li>The [PROJECTOR SETUP] menu → [ECO MANAGEMENT] → [QUICK STARTUP] is set to [ON]</li> <li>The [PROJECTOR SETUP] menu → [AUDIO SETTING] → [IN STANDBY MODE] is set to [OFF]</li> </ul> </li> <li>The projector may not operate when the light source indicator &lt;LIGHT&gt; or the temperature indicator &lt;TEMP&gt; is blinking. (➡ page 196)</li> </ul>
Green	Lit	Projecting.
Orange	Lit	The projector is preparing to switch off the projector. The power is switched off after a while. (Changes to the standby mode.)

### Note

- While the power indicator <ON (G)/STANDBY (R)> lights in orange, the fan is running to cool the projector.
- For approximately five seconds after the projector is turned off, the indicator does not light up even if the power is turned on. Turn on the power again after the power indicator <ON (G)/STANDBY (R)> lights/blinks in red.
- The projector consumes power even in standby mode (power indicator <ON (G)/STANDBY (R)> lights/blinks in red). Refer to “Power consumption” (➡ page 219) for the power consumption.
- The power indicator <ON (G)/STANDBY (R)> will blink if the projector receives a remote control signal.
- The power indicator <ON (G)/STANDBY (R)> will blink slowly in green while the shutter function is in use (shutter: closed).

## Switching on the projector

When using the optional projection lens, attach the projection lens before switching on the projector.  
Remove the lens cover first.

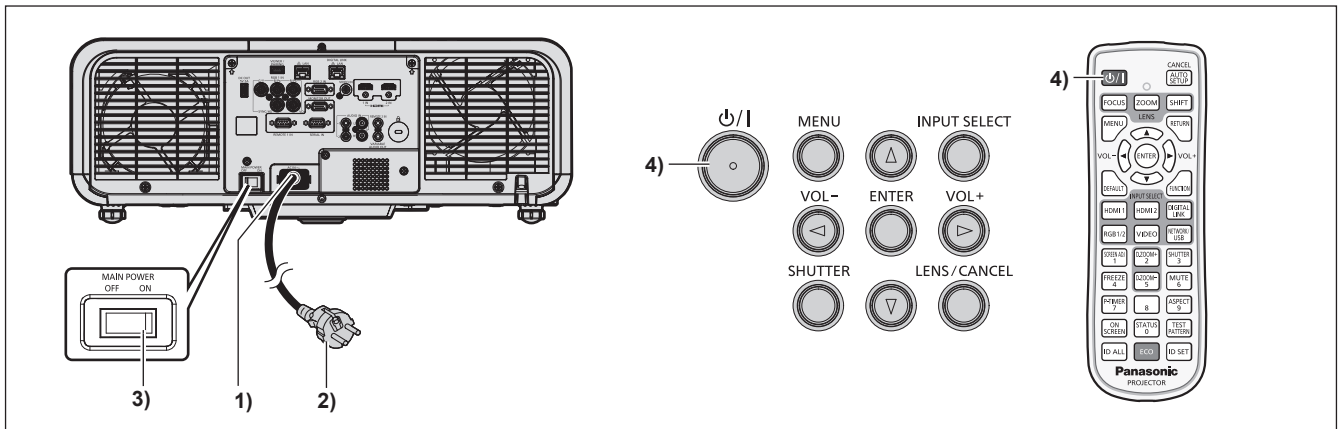

- 1) **Connect the power cord to the projector.**
- 2) **Connect the power plug to an outlet.**
- 3) **Press the <ON> side of the <MAIN POWER> switch to turn on the power.**
  - The power indicator <ON (G)/STANDBY (R)> lights/blinks in red, and the projector enters the standby mode.
- 4) **Press the power <ON/OFF> button.**
  - The power indicator <ON (G)/STANDBY (R)> lights in green and the image is soon projected on the screen.

### Note

- When the [PROJECTOR SETUP] menu → [ECO MANAGEMENT] → [STANDBY MODE] is set to [ECO], it takes longer for the projection to start after the power is turned on, compared to when set to [NORMAL].
- When the [PROJECTOR SETUP] menu → [ECO MANAGEMENT] → [QUICK STARTUP] is set to [ON], and the power is turned on before the specified time elapses after the projector enters the standby mode, an image will be projected approximately one second after the power is turned on.  
The specified time is a time set in the [PROJECTOR SETUP] menu → [ECO MANAGEMENT] → [QUICK STARTUP] → [VALID PERIOD].
- When the power is turned on or an input signal is switched, you may here a high-frequency driving sound. This is not a malfunction.
- If the power was turned off at the previous use by pressing the <OFF> side of the <MAIN POWER> switch or by using the breaker directly while projecting, the power indicator <ON (G)/STANDBY (R)> lights up in green and an image is projected after a while when the power is turned on by pressing the <ON> side of the <MAIN POWER> switch or by turning the breaker on with the power plug connected to the outlet. This applies only when the [PROJECTOR SETUP] menu → [INITIAL STARTUP] is set to [LAST MEMORY].

## When the initial setting screen is displayed

When the projector is switched on for the first time after purchase, or when the [PROJECTOR SETUP] menu → [INITIALIZE] → [ALL USER DATA] is executed, the focus adjustment screen is displayed immediately after the projection is started, and then the [INITIAL SETTING] screen is displayed. Set them according to the circumstances.

In other occasions, you can change the settings by menu operations.

If you press the <MENU> button while the [INITIAL SETTING] screen is displayed, you can go back to the previous screen.

Same operation is available by pressing the <RETURN> button.

## Focus adjustment

Adjust the focus to display the menu screen clearly.

Adjustment of the zoom and shift may also be necessary.

For details, refer to “Adjusting the focus, zoom, and lens shift” (➔ page 67).

- 1) Press ▲▼◀▶ to adjust the focus.

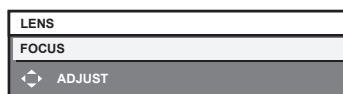

- 2) Press the <MENU> button to proceed to the initial setting.

## Initial setting (display language)

Select the language to show on the screen.

After completed the initial setting, you can change the display language from the [DISPLAY LANGUAGE] menu.

- 1) Press ▲▼◀▶ to select the display language.

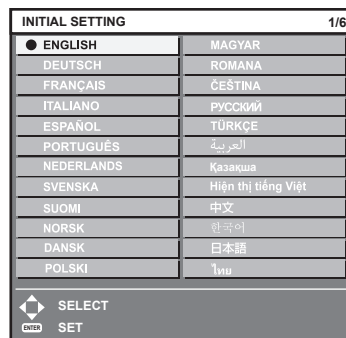

- 2) Press the <ENTER> button to proceed to the initial setting.

### Initial setting (installation setting)

Set [FRONT/REAR] and [FLOOR/CEILING] in [PROJECTION METHOD] depending on the installation mode. Refer to “Installation mode” (➔ page 35) for details.

After completed the initial setting, you can change the setting from the [PROJECTOR SETUP] menu → [PROJECTION METHOD].

1) Press ◀▶ to switch the setting.

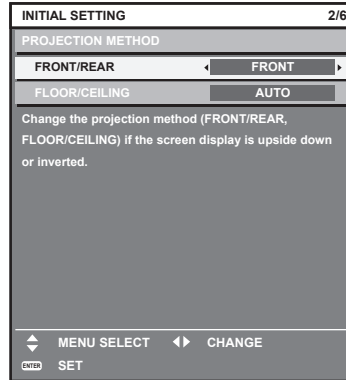

2) Press the <ENTER> button to proceed to the initial setting.

### Initial setting (standby mode)

Set the operation mode during standby. The factory default setting is [NORMAL], which allows you to use the network function during standby. To keep power consumption low during standby, set this item to [ECO].

After completed the initial setting, you can change the setting from the [PROJECTOR SETUP] menu → [ECO MANAGEMENT] → [STANDBY MODE].

1) Press ◀▶ to switch the setting.

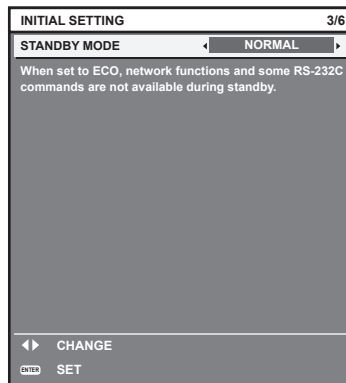

2) Press the <ENTER> button to proceed to the initial setting.

### Note

- The preceding initial setting screen is displayed when the projector is switched on for the first time after purchase. When the [PROJECTOR SETUP] menu → [INITIALIZE] → [ALL USER DATA] is executed, the [STANDBY MODE] setting before executing is displayed.

### Initial setting (screen setting)

Set the screen format (aspect ratio) and display position of the image.

After completed the initial setting, you can change the settings of each item from the [DISPLAY OPTION] menu → [SCREEN SETTING].

1) Press ◀▶ to switch the setting.

- Proceed to Step 4) when [16:10] is selected.

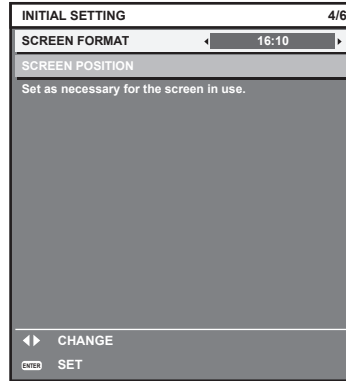

2) Press ▲▼ to select [SCREEN POSITION].

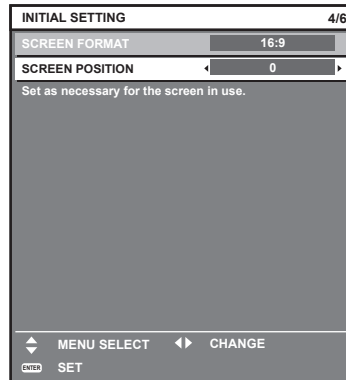

3) Press ◀▶ to adjust.

- The display position can be adjusted vertically when [16:9] is selected in [SCREEN FORMAT], and adjusted horizontally when [4:3] is selected.

4) Press the <ENTER> button to proceed to the initial setting.

### Initial setting (time zone)

Set [TIME ZONE] in accordance with the country or region where you use the projector.

After completed the initial setting, you can change the setting from the [PROJECTOR SETUP] menu → [DATE AND TIME]. The current settings are displayed in [LOCAL DATE] and [LOCAL TIME].

1) Press ◀▶ to switch the setting.

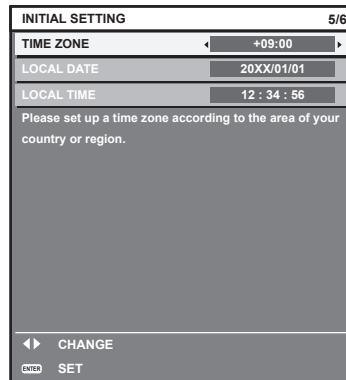

2) Press the <ENTER> button to proceed to the initial setting.

#### Note

- In the factory default setting, the time zone of the projector is set to +09:00 (Japan and Korea Standard Time). Change the setting of the [PROJECTOR SETUP] menu → [DATE AND TIME] → [TIME ZONE] to the time zone of the region where you use the projector.

### Initial setting (date and time)

Set the local date and time. After completed the initial setting, you can change the setting from the [PROJECTOR SETUP] menu → [DATE AND TIME].

To set the date and time automatically, refer to “Setting the date and time automatically” (➔ page 117).

1) Press ▲▼ to select an item.

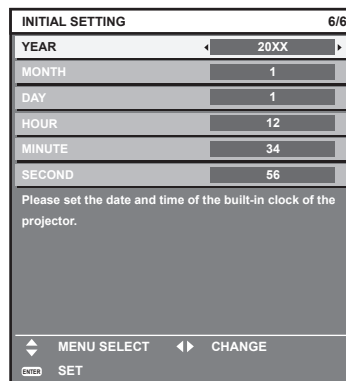

2) Press ◀▶ to switch the setting.

3) Press the <ENTER> button.

- Confirm the setting value and complete the initial setting.

## Making adjustments and selections

It is recommended that images be projected continuously for at least 30 minutes before the focus is adjusted.

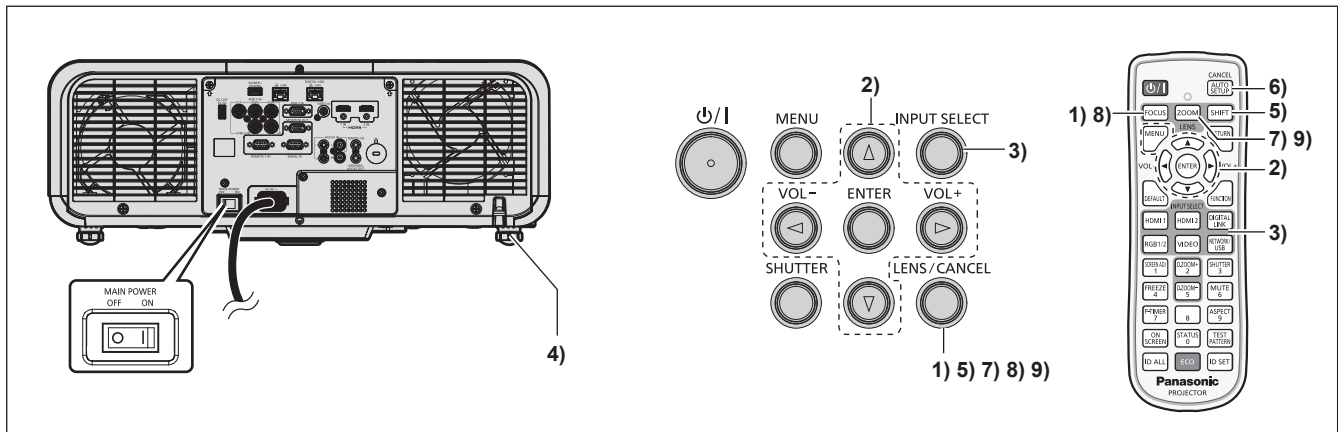

- 1) Press the <FOCUS> button to roughly adjust the focus of the projected image. (➔ page 67)
- 2) Change the setting of the [PROJECTOR SETUP] menu → [PROJECTION METHOD] depending on the installation mode. (➔ page 35)
  - Refer to “Navigating through the menu” (➔ page 79) for the operation of the menu screen.
- 3) Select the input by pressing the input selection button on the remote control or the control panel.
  - The buttons that can be used on the remote control or the control panel are as follows.
 

**Remote control:**  
 <HDMI 1> button, <HDMI 2> button, <DIGITAL LINK> button, <RGB1/2> button, <VIDEO> button, <NETWORK/USB> button

**Control panel:**  
 <INPUT SELECT> button
  - For details of operation for input selection, refer to “Selecting the input signal” (➔ page 66).
- 4) Adjust the front, back and sideway tilt of the projector with the adjustable feet. (➔ page 47)
- 5) Press the <SHIFT> button to adjust the position of the projected image. (➔ page 67)
- 6) If the input signal is the analog RGB signal, press the <AUTO SETUP/CANCEL> button to automatically adjust the projection position.
- 7) Press the <ZOOM> button to adjust the projected image size to match the screen.
- 8) Press the <FOCUS> button again to adjust the focus. (➔ page 67)
- 9) Press the <ZOOM> button again to adjust the zoom to match the projected image size to the screen.

### Note

- When the projector is switched on for the first time after purchase, or when the [PROJECTOR SETUP] menu → [INITIALIZE] → [ALL USER DATA] is executed, the focus adjustment screen is displayed immediately after the projection is started, and then the [INITIAL SETTING] screen is displayed. For details, refer to “When the initial setting screen is displayed” (➔ page 60).



## Switching off the projector

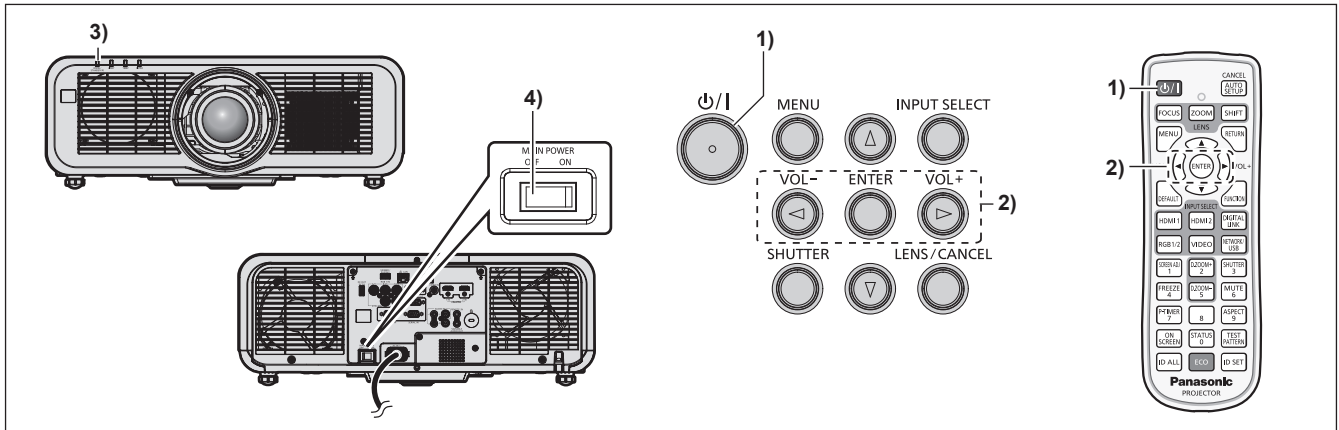

- 1) Press the power  $\phi/|$  button.
  - The [POWER OFF(STANDBY)] confirmation screen is displayed.
- 2) Press  $\blacktriangleleft\blacktriangleright$  to select [OK], and press the <ENTER> button.  
(Or press the power  $\phi/|$  button again.)
  - Projection of the image will stop, and the power indicator <ON (G)/STANDBY (R)> on the projector body lights in orange. (The fan keeps running.)
- 3) Wait for a few seconds until the power indicator <ON (G)/STANDBY (R)> of the projector body lights/blinks in red.
- 4) Press the <OFF> side of the <MAIN POWER> switch to turn off the power.

### Note

- For approximately five seconds after the projector is turned off, the indicator does not light up even if the power is turned on.
- Even when the power  $\phi/|$  button is pressed and the projector is switched off, the projector consumes power if the main power of the projector is on.  
When the [PROJECTOR SETUP] menu → [ECO MANAGEMENT] → [STANDBY MODE] is set to [ECO], use of some functions is restricted, but the power consumption during standby mode can be conserved.
- While projecting, the power can be turned off by pressing the <OFF> side of the <MAIN POWER> switch, or by directly using the breaker under conditions where the <MAIN POWER> switch of the projector cannot be switched off/on easily such as while installing on the ceiling. However, the settings or adjustments performed right before the power is turned off may not be reflected.

# Projecting

Check the external device connection (➔ page 51) and the power cord connection (➔ page 57), and turn on the power (➔ page 59) to start projection. Select the image to project, and adjust appearance of the projected image.

## Selecting the input signal

The input of the image to project can be switched. Method to switch the input is as follows.

- Press the input selection button on the remote control and directly specify the input of the image to project.
- Press the <INPUT SELECT> button on the control panel to display the input selection screen, and select the input to project from the list.

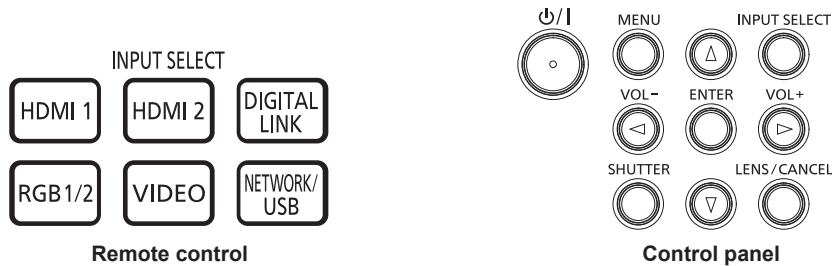

## Switching the input directly with the remote control

The input for projection can be switched by directly specifying it with the input selection button on the remote control.

- 1) Press the input selection button (<HDMI 1>, <HDMI 2>, <DIGITAL LINK>, <RGB1/2>, <VIDEO>, <NETWORK/USB>).

<HDMI 1>	Switches the input to HDMI1. The image of the signal input to the <HDMI 1 IN> terminal is projected.
<HDMI 2>	Switches the input to HDMI2. The image of the signal input to the <HDMI 2 IN> terminal is projected.
<DIGITAL LINK>	Switches the input to DIGITAL LINK. The image of the signal input to the <DIGITAL LINK/LAN> terminal is projected.
<RGB1/2>	Switches the input to RGB1 or RGB2. Switches to the other input when one input has already been selected. The image of the signal input to the <RGB 1 IN> terminal or the <RGB 2 IN> terminal is projected.
<VIDEO>	Switches the input to VIDEO. The image of the signal input to the <VIDEO IN> terminal is projected.
<NETWORK/USB>	Switches the input to MEMORY VIEWER, Panasonic APPLICATION, or MIRRORING. If any of the input is selected already, the input is switched every time the button is pressed. <ul style="list-style-type: none"> <li>• MEMORY VIEWER: Displays the still image or movie recorded in the USB memory using the Memory Viewer function. (➔ page 185)</li> <li>• Panasonic APPLICATION: Displays the image transferred via wireless LAN/wired LAN from a computer (including iPad/iPhone/iPod touch, Android device) using the Panasonic image transfer application software. (➔ page 178)</li> <li>• MIRRORING: Displays the image transferred via wireless LAN from the Miracast supported device using the mirroring function. (➔ page 181)</li> </ul>

## Attention

- Images may not be projected properly depending on the external device, or the Blu-ray disc or DVD disc, to be played back. Set the [PICTURE] menu → [SYSTEM SELECTOR].
- Confirm the aspect ratio of the projection screen and the image, and switch to an optimum aspect ratio from the [POSITION] menu → [ASPECT].

## Note

- To switch the input to MIRRORING, it is necessary to attach the optional Wireless Module (Model No.: ET-WM300). For details on how to attach the optional Wireless Module (Model No.: ET-WM300), refer to “Attaching the Wireless Module” (➔ page 50).
- When the optional DIGITAL LINK output supported device (Model No.: ET-YFB100G, ET-YFB200G) is connected to the <DIGITAL LINK/LAN> terminal, the input on the DIGITAL LINK output supported device changes each time the <DIGITAL LINK> button is pressed. The input can also be changed using the RS-232C control command. For twisted-pair-cable transmitters of other manufacturers, switch the input on the projector to DIGITAL LINK, and then switch the input on the twisted-pair-cable transmitter. For details of the RS-232C operation command, refer to “<SERIAL IN> terminal” (➔ page 213).

## Switching the input by displaying the input selection screen

The input for projection can be selected by displaying the input selection screen using the <INPUT SELECT> button on the control panel.

### 1) Press the <INPUT SELECT> button on the control panel.

- The input selection screen is displayed.

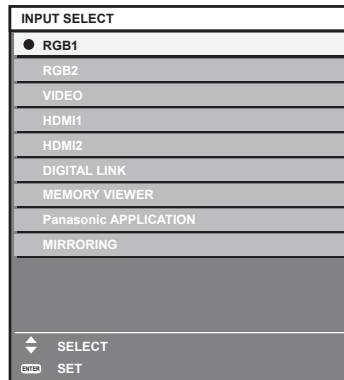

### 2) Press ▲▼ to select the input for projection, and press the <ENTER> button.

#### Note

- [MIRRORING] is displayed when the optional Wireless Module (Model No.: ET-WM300) is attached.
- The input can also be switched by pressing the <INPUT SELECT> button while the input selection screen is displayed. The input will switch each time you press the <INPUT SELECT> button.
- If the optional DIGITAL LINK output supported device (Model No.: ET-YFB100G, ET-YFB200G) is connected to the projector, the input selection menu for the DIGITAL LINK output supported device is displayed when the <ENTER> button is pressed while the DIGITAL LINK input is selected in the input selection screen.
- If the optional DIGITAL LINK output supported device (Model No.: ET-YFB100G, ET-YFB200G) is connected to the projector, the DIGITAL LINK logo and the input name selected in the DIGITAL LINK output supported device are displayed in the display section of the [DIGITAL LINK] in the input selection screen.

## Adjusting the focus, zoom, and lens shift

Adjust the focus, zoom, and lens shift if the image projected to the screen or its position is shifted even if the projector and the screen are set up in the correct positions.

### Using the control panel

#### 1) Press the <LENS/CANCEL> button on the control panel.

- Pressing the button changes the adjustment screen in the order of [FOCUS], [ZOOM], and [SHIFT].

#### 2) Select each adjustment item and press ▲▼◀▶ to adjust.

### Using the remote control

#### 1) Press the lens buttons (<FOCUS>, <ZOOM>, <SHIFT>) on the remote control.

- Pressing the <FOCUS> button: Adjusts the focus (adjustment of the lens focus position).
- Pressing the <ZOOM> button: Adjusts the zoom (adjustment of the lens zoom position).
- Pressing the <SHIFT> button: Adjusts the lens shift (vertical position and horizontal position of the lens).

#### 2) Select each adjustment item and press ▲▼◀▶ to adjust.

## CAUTION

During the lens shift operation, do not insert your hand in the opening around the lens.  
Your hand may get caught, resulting in an injury.

#### Note

- The adjustment can be performed faster by holding down ▲▼◀▶ for approximately three seconds or longer.
- It is recommended that images be projected continuously for at least 30 minutes before the focus is adjusted.

- Only [FOCUS] is displayed in yellow so that the displayed menu item can be recognized by color, even when the displayed characters are unreadable due to incorrect focus. (Factory default)  
The displayed color for [FOCUS] differs depending on the setting in the [DISPLAY OPTION] menu → [ON-SCREEN DISPLAY] → [OSD DESIGN].
- The current position and maximum movable range are displayed with a bar scale during shift adjustment.  
Also, the out of movable range from current position is indicated by red bar.  
The triangular mark under the bar scale indicates the home position.

## Moving the lens position to the home position

To move the lens position to the home position, operate in following procedure.

- 1) Press the <DEFAULT> button on the remote control while the [SHIFT] adjustment screen is displayed.
  - The [HOME POSITION] screen is displayed.

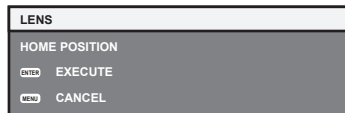

- 2) Press the <ENTER> button while the [HOME POSITION] screen is displayed (approximately five seconds).
  - [PROGRESS] is displayed in the [HOME POSITION] screen, and the lens position returns to the home position.

### Note

- The home position of the lens is used when the lens is replaced or when the projector is stored, and it is not the optical center of the screen.
- The [HOME POSITION] screen can also be displayed by pressing the <LENS/CANCEL> button on the control panel or the <SHIFT> button on the remote control for three seconds or longer.

## Adjustment range by the lens position shift (optical shift)

Based on the standard projection position using the optical axis shift function, the projection position can be adjusted in the range shown in the following figure.

Following figure shows the adjustment range when the projector is installed on the floor.

Projection lens Model No.	Standard zoom lens/ET-ELS20/ET-ELW20/ ET-ELT20/ET-ELT21	ET-ELW22
Lens shift range	<p>Projected image width H</p> <p>0.35 H 0.35 H</p> <p>0.30 H 0.30 H</p> <p>0.67 V</p> <p>0.19 V 0.19 V</p> <p>Projected image height V</p> <p>Standard projection position</p>	<p>Projected image width H</p> <p>0.30 H 0.30 H</p> <p>0.25 H 0.25 H</p> <p>0.60 V</p> <p>0.15 V 0.15 V</p> <p>Projected image height V</p> <p>Standard projection position</p>

## Using the USB memory

This projector supports the attachment of the USB memory. Attach the USB memory to the <VIEWER/PAIRING> terminal when using the Memory Viewer function, the pairing function, or the data cloning function.

### Note

- For details on the Memory Viewer function, refer to “Projecting with MEMORY VIEWER input” (➔ page 185).
- For pairing of the projector and the USB memory, refer to “Using the pairing function” (➔ page 193).
- For how to use the image transfer application software “Plug and Share” allowing to easily connect via the wireless LAN by pairing the commercially available USB memory with the projector, refer to following URL.  
<https://panasonic.net/cns/projector/>  
For the method of pairing the projector and the USB memory, refer to “Using the pairing function” (➔ page 193). By pairing, the connection information between the image transfer application software “Plug and Share”, and the projector and the USB memory is written into the USB memory.
- For the data cloning function, refer to the [PROJECTOR SETUP] menu → [DATA CLONING] (➔ page 126).

### Notes on use

Observe following.

- Do not disassemble or modify the USB memory.
- Do not apply strong impact on the USB memory.
- Do not pour liquid such as water or get it wet.
- Do not place foreign object into the terminal section.
- Do not touch the metal terminal with hand or metal.
- Do not leave the USB memory in a place with high humidity or dust.
- Do not leave the USB memory in a place where static electricity or electromagnetic radiation is generated.
- Store the USB memory appropriately in a location that small children cannot reach.
- Immediately remove the USB memory from the projector when smoke or odor is noticed, and contact the manufacturer.
- Do not remove the USB memory from the projector while reading or writing the data.

### USB memory that can be used with the projector

This projector supports the commercially available USB 2.0 compatible USB memory formatted in FAT16 or FAT32.

- Only the single partition structure is supported.

### Note

- The USB memory with a security function cannot be used for pairing.
- Free space of approximately 30 MB is required in the USB memory used for pairing.

### Attaching the USB memory

1) Insert the USB memory all the way in to the <VIEWER/PAIRING> terminal.

#### Attention

- Take care of the orientation of the terminal when inserting the USB memory so that it will not get damaged.
- Do not use a USB extension cable or a USB hub, and directly insert the USB memory into the <VIEWER/PAIRING> terminal of the projector.
- Do not insert the USB memory into the <DC OUT> terminal. The USB memory cannot be used on the <DC OUT> terminal.

#### Note

- The USB memory can be attached even when the projector is turned on.
- The pairing data is written to the USB memory when the pairing function is used. If there is a write protection switch on the USB memory to be used, set it so that data can be written.

## Removing the USB memory

---

- 1) Remove the USB memory after confirming that the indicator on the USB memory is not blinking.

### Attention

---

---

- The blinking of the indicator of the USB memory attached to the projector is indicating that the projector is accessing (reading or writing) the USB memory. Do not remove the USB memory from the projector when the indicator is blinking.
- The access status to the USB memory cannot be confirmed when a USB memory without the monitoring function such as indicator is used. In such case, remove the USB memory after waiting for one of following is completed.
  - Turn off the projector.
  - When using the Memory Viewer function, switch the input to anything other than the MEMORY VIEWER input.
  - When using the pairing function, wait until the pairing data write completion message is displayed on the standby screen.

# Operating with the remote control

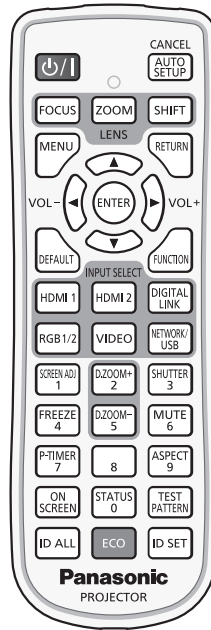

## Using the shutter function

If the projector is not used for a certain period of time during the meeting intermission, for example, it is possible to turn off the image and audio temporarily.

### **SHUTTER 3** button

- 1) **Press the <SHUTTER> button.**
  - The image and audio disappear.
  - This operation can be also performed by pressing the <SHUTTER> button on the control panel.
- 2) **Press the <SHUTTER> button again.**
  - The image and audio reappear.

### Note

- The power indicator <ON (G)/STANDBY (R)> will blink slowly in green while the shutter function is in use (shutter: closed).
- The fade-in/fade-out time of the image can be set in the [DISPLAY OPTION] menu → [SHUTTER SETTING] (► page 108).
- To output audio while the shutter function is in use (shutter: closed), set the [PROJECTOR SETUP] menu → [AUDIO SETTING] (► page 122) → [IN SHUTTER] to [ON].
- The light source may be lit dimly due to warm up when the shutter function is used in the operating environment temperature of around 0 °C (32 °F).

## Using the mute function

Audio can be temporarily turned off.

### **MUTE 6** button

- 1) **Press the <MUTE> button.**
  - The audio is muted.
- 2) **Press the <MUTE> button again.**
  - The audio is turned on.

## Adjusting the volume

Adjust the volume of audio output.



- 1) Press the <VOL-> button/<VOL+> button on the remote control.

<VOL+>	Increases the volume.
<VOL->	Decreases the volume.

### Note

- This operation can be also performed using ◀▶ on the control panel.

## Using the freeze function

The projected image can be paused and audio can be turned off regardless of the playback of the external device.



- 1) Press the <FREEZE> button.
  - The image freezes and audio is muted.
- 2) Press the <FREEZE> button again.
  - Freezing of the image is canceled and audio is turned on.

### Note

- [FREEZE] is displayed on the screen when video is paused.
- When freezing of the moving image is canceled, the image may disappear or be disrupted temporarily.

## Using the on-screen display function

Turn off the on-screen display function (no display) when you do not wish the viewers to see the on-screen display, such as the menu or the input terminal name.



- 1) Press the <ON SCREEN> button.
  - The on-screen display disappears.
- 2) Press the <ON SCREEN> button again.
  - The on-screen display appears.

### Note

- If you press the <MENU> button on the control panel for at least three seconds while the on-screen display is off (hidden), the on-screen display is turned on.



## Using the automatic setup function

The image position when the HDMI signal is input, or the dot clock, clock phase, and image position when the analog RGB signal is input can be adjusted automatically. (Analog RGB signal is a signal structured with dots just like the computer signal.)

It is recommended to input an image with bright white borders at the edges and high-contrast black and white characters when the automatic adjustment is being performed.

Avoid using images that include halftones or gradation, such as photographs and computer graphics.

CANCEL



button

### 1) Press the <AUTO SETUP/CANCEL> button.

- [PROGRESS] is displayed while automatic setup is being executed.
- [COMPLETE] is displayed when automatic setup has completed without any problem.

### Note

- The clock phase may shift even if it has completed without any incident. In such a case, adjust the [POSITION] menu → [CLOCK PHASE] (➡ page 91).
- The automatic setup may not correctly adjust when an image that cannot determine the edge or dark image is input. In such a case, adjust the following settings.
  - [ADVANCED MENU] menu → [INPUT RESOLUTION] (➡ page 96)
  - [POSITION] menu → [CLOCK PHASE] (➡ page 91)
  - [POSITION] menu → [SHIFT] (➡ page 89)
- Adjust special signals according to the [DISPLAY OPTION] menu → [AUTO SETUP] (➡ page 100).
- Automatic adjustment may not be possible depending on the computer model.
- Automatic adjustment may not be possible for the synchronization signal for composite sync or SYNC ON GREEN.
- Image may be disrupted for a few seconds during automatic adjustment, but this is not a malfunction.
- Adjustment is required for each input signal.
- Automatic adjustment can be canceled by pressing the <MENU> button or the <RETURN> button during the automatic adjustment operation.
- Even if a signal possible to perform the automatic setup is being input, it may not be able to adjust correctly if the automatic setup function is used while the moving image is being input.
- If the [DISPLAY OPTION] menu → [SIGNAL SEARCH] is set to [ON], the signal search function is activated when the <AUTO SETUP/CANCEL> button is pressed while no signal is input.  
For details of the signal search function, refer to the [DISPLAY OPTION] menu → [SIGNAL SEARCH] (➡ page 107).

## Using the screen adjustment function

The [SCREEN ADJUSTMENT] menu can be displayed.

Correct the distortion of the image that occurs when the projector is installed tilted or when the screen is tilted or curved.



button

### 1) Press the <SCREEN ADJ> button.

- The [SCREEN ADJUSTMENT] screen is displayed.

### 2) Press ◀▶ to switch the item.

- The items will switch each time you press the button.

[OFF]	Disables the screen adjustment function.
[KEystone]	Adjusts any trapezoidal distortion in the projected image.
[CORNER CORRECTION]	Adjusts any distortion in the four corners of the projected image.
[CURVED CORRECTION]	Adjusts any curved distortion in the projected image.

- The items will also switch by pressing the <SCREEN ADJ> button.
- Proceed to Step 3) when anything other than [OFF] is selected.

### 3) Press the <ENTER> button.

- The [KEystone] screen, the [CORNER CORRECTION] screen, or the [CURVED CORRECTION] screen is displayed.

**Note**

- To adjust [KEystone] or [CURVED CORRECTION], press ▲▼ to select the item to adjust, and press ◀▶ to adjust the item.
- To adjust [CORNER CORRECTION], press ▲▼ to select the item to adjust. Individual adjustment screen is displayed by pressing the <ENTER> button. Adjust the item using ▲▼◀▶.
- Only one of the [KEystone], [CORNER CORRECTION], or [CURVED CORRECTION] setting is enabled.
- Refer to the [POSITION] menu → [SCREEN ADJUSTMENT] (➔ page 92) for details.

**Using the digital zoom function**

(When RGB signal for still images, HDMI signal for still images, or DIGITAL LINK signal for still images is input. Or, when MEMORY VIEWER, Panasonic APPLICATION, or MIRRORING is input.)

Enlarge the image or move the enlargement area of the image.



**1) Press the <D.ZOOM-> button/<D.ZOOM+> button.**

- When executed from the remote control operation, the [DIGITAL ZOOM] individual adjustment screen is not displayed, and the move screen is displayed.
- When executed from the menu operation, the [DIGITAL ZOOM] individual adjustment screen is displayed. For details, refer to the [DISPLAY OPTION] menu → [DIGITAL ZOOM] (➔ page 110).

**2) Move the enlargement position or adjust the magnification with following button operation.**

- The digital zoom is canceled when the <AUTO SETUP/CANCEL> button on the remote control or the <LENS/CANCEL> button on the control panel is pressed while performing the digital zoom.

Operation menu/button	Operation	Adjustment
<p>Remote control operation button</p>	Press ▲.	The image moves down.
	Press ▼.	The image moves up.
	Press ◀.	The image moves right.
	Press ▶.	The image moves left.
	Press the <MENU> button.	Displays the top left corner.
	Press the <RETURN> button.	Displays the top right corner.
	Press the <ENTER> button.	Displays the center.
	Press the <DEFAULT> button.	Displays the bottom left corner.
	Press the <FUNCTION> button.	Displays the bottom right corner.
	Press the <D.ZOOM+> button.	Increases the magnification.
	Press the <D.ZOOM-> button.	Decreases the magnification.

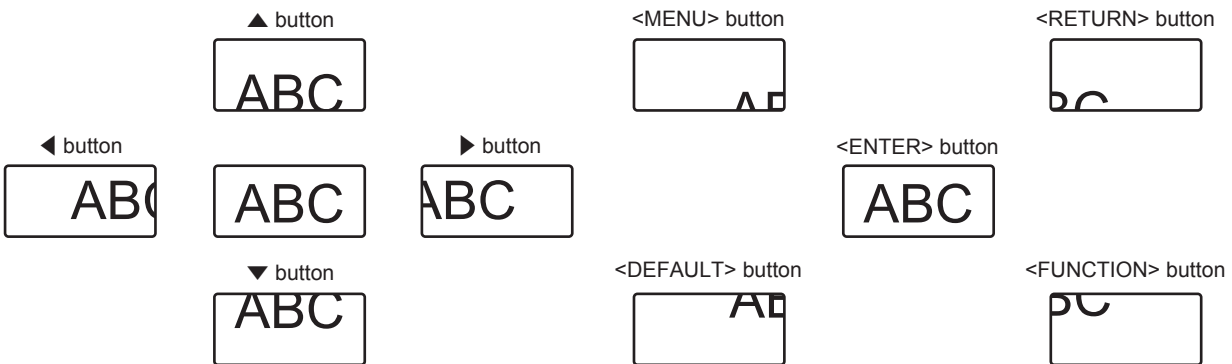

The screen display position after the button operation

**Note**

- The magnification is not displayed in the move screen.
- The adjustment value of the digital zoom is canceled when the type of input signal is changed while performing the digital zoom.
- The freeze function is disabled while performing the digital zoom.
- The digital zoom will not operate in some of the still image signals.

## Switching the image aspect ratio

Switch the image aspect ratio according to the input.



### 1) Press the <ASPECT> button.

- The setting will change each time you press the button.

#### Note

- Refer to the [POSITION] menu → [ASPECT] (➡ page 89) for details.

## Using the presentation timer function

The presentation timer can be operated.

The presentation can be performed while confirming the elapsed time or remaining time against the specified time.



### 1) Press the <P-TIMER> button.

- Starts the count.

### 2) Press the <P-TIMER> button again.

- Stops the count.

#### Note

- The elapsed time or remaining time is displayed at the bottom right of the projected image while using the presentation timer.
- The count will restart when the <P-TIMER> button is pressed while the count is stopped.
- The presentation timer is ended when the <P-TIMER> button is pressed and held for 3 seconds or longer.
- For details such as setting of the presentation timer function, refer to the [DISPLAY OPTION] menu → [P-TIMER] (➡ page 109).

## Using the function button

By assigning the following functions to the <FUNCTION> button, it can be used as a simplified shortcut button. [SUB MEMORY], [SYSTEM SELECTOR], [DAYLIGHT VIEW]



### 1) Press the <FUNCTION> button.

#### Note

- Assignment of the function is performed from the [PROJECTOR SETUP] menu → [FUNCTION BUTTON] (➡ page 121).

## Displaying internal test pattern

To confirm the status of the projector, ten types of internal test patterns can be displayed. To display test patterns, perform the following steps.



### 1) Press the <TEST PATTERN> button.

### 2) Press ◀▶ to select the test pattern.

#### Note

- Test patterns can also be displayed using the menu operation. Refer to "[TEST PATTERN] menu" (➡ page 131) for details.
- Settings of position, size, and other factors will not be reflected in test patterns. Make sure to display the input signal before performing various adjustments.

## Using the status function

Display the status of the projector.



- 1) Press the <STATUS> button.
  - The [STATUS] screen is displayed.

STATUS		1/3
PROJECTOR TYPE	PT-MZ670	
SERIAL NUMBER	SW1234567	
PROJECTOR RUNTIME	10000h	
LIGHT RUNTIME	10000h / 10000h	
CONTINUOUS LIGHTING TIME	1h 23m	
MAIN/SUB VERSION	1.00 / 1.00	
NETWORK VERSION	1.00	
INTAKE AIR TEMP.	31°C/87°F	
EXHAUST AIR TEMP.	31°C/87°F	
LIGHT TEMP. 1	31°C/87°F	
LIGHT TEMP. 2	31°C/87°F	
SELF TEST	NO ERRORS	
SEND E-MAIL		
CHANGE	EXIT	

### Note

- The projector status can also be displayed using the menu operation. Refer to the [PROJECTOR SETUP] menu → [STATUS] (➔ page 125) for details.

## Using the ECO management function

Display the setting screen relating to ECO management.



- 1) Press the <ECO> button.

### Note

- Refer to the [PROJECTOR SETUP] menu → [ECO MANAGEMENT] (➔ page 113) for details.

## Setting ID number of the remote control

When you use the multiple projectors together, you can operate all the projectors simultaneously or each projector individually using a single remote control, if a unique ID number is assigned to each projector.

After setting the ID number of the projector, set same ID number on the remote control.

**The factory default ID number of the projector is set to [ALL]. When using a single projector, press the <ID ALL> button on the remote control. Also, you can control a projector by pressing the <ID ALL> button on the remote control even if you do not know the projector ID.**



- 1) Press the <ID SET> button on the remote control.
- 2) Within five seconds, press and set the one-digit or two-digit ID number set on the projector body using the number (<0> - <9>) buttons.
  - If you press the <ID ALL> button, you can control the projectors regardless of the ID number setting of the projector body.

### Attention

- Since the ID number of the remote control can be set without the projector body, do not press the <ID SET> button on the remote control carelessly. If the <ID SET> button is pressed and no number (<0> - <9>) buttons are pressed within five seconds, the ID number returns to its original value before the <ID SET> button was pressed.

- The ID number set on the remote control will be stored unless it is set again. However, it will be erased if the remote control is left with dead batteries. Set the same ID number again when the batteries are replaced.

### Note

---

---

- When the ID number of the remote control is set to [0], the projectors can be controlled regardless of the ID number setting on the projector, same as when set to [ALL].
- Set the ID number of the projector from the [PROJECTOR SETUP] menu → [PROJECTOR ID] (➔ page 112).

# Chapter 4 Settings

---

This chapter describes the settings and adjustments you can make using the on-screen menu.

# Menu navigation

The on-screen menu (Menu) is used to perform various settings and adjustments of the projector.

## Navigating through the menu

### Operating procedure



button

1) Press the <MENU> button on the remote control or control panel.

- The [MAIN MENU] screen is displayed.

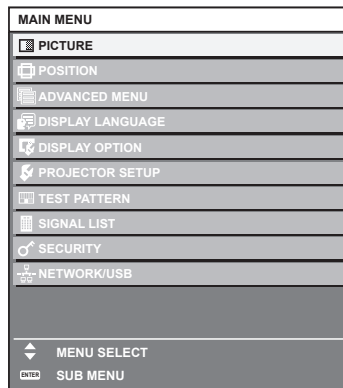

2) Press ▲▼ to select an item from the main menu.

- The selected item is highlighted in yellow.

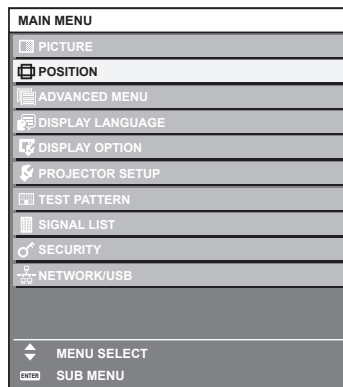

3) Press the <ENTER> button.

- The sub-menu items of the selected main menu are displayed.

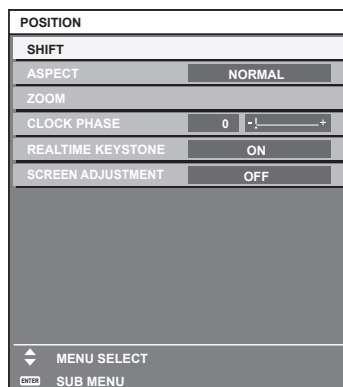

4) Press ▲▼ to select a sub-menu, and press ◀▶ or the <ENTER> button to change or adjust settings.

- Some items will switch in order as follows each time you press ◀▶.

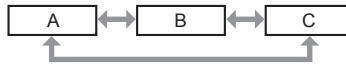

- For some items, press ◀▶ to display an individual adjustment screen with a bar scale as shown below.



**Note**

- Pressing the <MENU> button while the menu screen is displayed returns to the previous menu. Same operation is available by pressing the <RETURN> button.
- Some items cannot be adjusted or some functions cannot be used depending on the signal that is input to the projector. The item in the menu screen is displayed in black text when it cannot be adjusted or selected. If the item in the menu screen is displayed in black characters and the item cannot be adjusted or set, the factor causing it is displayed by pressing the <ENTER> button while the corresponding menu is selected.
- Some items can be adjusted even if signals are not input.
- Individual adjustment screen is cleared automatically if no operation is performed for approximately five seconds.
- For menu items, refer to “Main menu” (➔ page 80) and “Sub-menu” (➔ page 81).
- The cursor color depends on the setting in the [DISPLAY OPTION] menu → [ON-SCREEN DISPLAY] → [OSD DESIGN]. The selected item is displayed with the yellow cursor by the factory default.
- In the portrait setting, the on-screen menu is displayed sideways. To display the on-screen menu vertically, change the setting of the [DISPLAY OPTION] menu → [ON-SCREEN DISPLAY] → [OSD ROTATION].

**Resetting adjustment values to the factory default**

If the <DEFAULT> button on the remote control is pressed, the values adjusted in the menu items are restored to the factory default settings.



1) Press the <DEFAULT> button on the remote control.



**Note**

- You cannot reset all the settings to the factory default at a time.
- To reset all the settings adjusted in the sub-menu item to the factory default one at a time, execute the [PROJECTOR SETUP] menu → [INITIALIZE].
- Some items cannot be reset to the factory default settings even when the <DEFAULT> button on the remote control is pressed. Adjust those items individually.
- The triangular mark under the bar scale in the individual adjustment screen indicates the factory default setting. The position of the triangular mark varies according to the selected input signals.

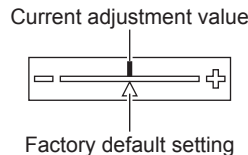







**Main menu**

The following items are in the main menu.

When a main menu item is selected, the screen changes to a sub-menu selection screen.

Main menu item		Page
	[PICTURE]	84
	[POSITION]	89
	[ADVANCED MENU]	95



Main menu item		Page
	[DISPLAY LANGUAGE]	98
	[DISPLAY OPTION]	99
	[PROJECTOR SETUP]	112
	[TEST PATTERN]	131
	[SIGNAL LIST]	132
	[SECURITY]	135
	[NETWORK/USB]	139

## Sub-menu

The sub-menu of the selected main menu item is displayed, and you can set and adjust items in the sub-menu.

### [PICTURE]

Sub-menu item	Factory default	Page
[PICTURE MODE]	[STANDARD] <sup>*1</sup>	84
[CONTRAST]	[0]	84
[BRIGHTNESS]	[0]	84
[COLOR]	[0] <sup>*2</sup>	85
[TINT]	[0]	85
[COLOR TEMPERATURE]	[DEFAULT] <sup>*2</sup>	85
[GAMMA]	[0]	86
[DAYLIGHT VIEW]	[AUTO] <sup>*2</sup>	87
[SHARPNESS]	[+6] <sup>*2</sup>	87
[NOISE REDUCTION]	[OFF] <sup>*2</sup>	87
[DYNAMIC CONTRAST]	[OFF] <sup>*2</sup>	88
[SYSTEM SELECTOR]	[AUTO] <sup>*1</sup>	88

\*1 Depends on the signal input.

\*2 Depends on the [PICTURE MODE].

### [POSITION]

Sub-menu item	Factory default	Page
[SHIFT]	—	89
[ASPECT]	[NORMAL] <sup>*1</sup>	89
[ZOOM]	—	90
[CLOCK PHASE]	[0] <sup>*1</sup>	91
[REALTIME KEYSTONE]	[OFF]	91
[SCREEN ADJUSTMENT]	[OFF]	92

\*1 Depends on the signal input.

### [ADVANCED MENU]

Sub-menu item	Factory default	Page
[DIGITAL CINEMA REALITY]	[AUTO] <sup>*1</sup>	95
[BLANKING]	—	95
[INPUT RESOLUTION]	—	96
[CLAMP POSITION]	[24] <sup>*1</sup>	96

Sub-menu item	Factory default	Page
[RASTER POSITION]	—	97

\*1 Depends on the signal input.

**Note**

- The factory default setting varies depending on the selected input terminal.

**[DISPLAY LANGUAGE]** 

Details (➔ page 98)

**[DISPLAY OPTION]** 

Sub-menu item	Factory default	Page
[COLOR ADJUSTMENT]	[OFF]	99
[COLOR CORRECTION]	[OFF]	99
[SCREEN SETTING]	—	100
[AUTO SIGNAL]	[OFF]	100
[AUTO SETUP]	—	100
[RGB IN]	—	101
[HDMI IN]	—	102
[DIGITAL LINK IN]	—	103
[ON-SCREEN DISPLAY]	—	104
[CLOSED CAPTION SETTING]	—	107
[SIGNAL SEARCH]	[ON]	107
[BACK COLOR]	[BLUE]	108
[STARTUP LOGO]	[DEFAULT LOGO]	108
[SHUTTER SETTING]	—	108
[P-TIMER]	—	109
[FREEZE]	—	110
[DIGITAL ZOOM]	—	110

**[PROJECTOR SETUP]** 

Sub-menu item	Factory default	Page
[PROJECTOR ID]	[ALL]	112
[PROJECTION METHOD]	—	112
[ECO MANAGEMENT]	—	113
[LightID]	[OFF]	115
[INITIAL STARTUP]	[LAST MEMORY]	116
[STARTUP INPUT SELECT]	[LAST USED]	116
[DATE AND TIME]	—	117
[SCHEDULE]	[OFF]	118
[RS-232C]	—	119
[REMOTE1 MODE]	[DEFAULT]	121
[FUNCTION BUTTON]	—	121
[LENS CALIBRATION]	—	121
[AUDIO SETTING]	—	122
[FILTER COUNTER]	—	124
[DC OUT]	[ON]	125
[STATUS]	—	125
[DATA CLONING]	—	126
[SAVE ALL USER DATA]	—	129
[LOAD ALL USER DATA]	—	129
[INITIALIZE]	—	129
[SERVICE PASSWORD]	—	130

**[TEST PATTERN]** 

Details (➔ page 131)

**[SIGNAL LIST]** 

Details (➔ page 132)

**[SECURITY]** 

Sub-menu item	Factory default	Page
[SECURITY PASSWORD]	[OFF]	135
[SECURITY PASSWORD CHANGE]	—	135
[DISPLAY SETTING]	[OFF]	135
[TEXT CHANGE]	—	136
[MENU LOCK]	[OFF]	136
[MENU LOCK PASSWORD]	—	136
[CONTROL DEVICE SETUP]	—	137
[CONTROL DEVICE PASSWORD CHANGE]	—	138

**[NETWORK/USB]** 

Sub-menu item	Factory default	Page
[DIGITAL LINK MODE]	[AUTO]	139
[DIGITAL LINK STATUS]	—	139
[DIGITAL LINK MENU]	—	140
[WIRED LAN]	—	140
[WIRELESS LAN]* <sup>1</sup>	[SIMPLE]	141
[PROJECTOR NAME]	—	145
[NETWORK CONTROL]	—	145
[MEMORY VIEWER]	—	145
[Panasonic APPLICATION]	—	147
[MIRRORING]* <sup>1</sup>	—	149
[NETWORK STATUS]	—	150

\*1 The sub-menu item can be selected when the optional Wireless Module (Model No.: ET-WM300) is attached.

**Note**

- Some items may not be adjusted or used for certain signal formats to be input to the projector.  
The item in the menu screen is displayed in black text when it cannot be adjusted or selected.
- Display of the sub-menu item and the value of factory default setting vary depending on the selected input.

## [PICTURE] menu

On the menu screen, select [PICTURE] from the main menu, and select an item from the sub-menu. Refer to “Navigating through the menu” (➔ page 79) for the operation of the menu screen.

### [PICTURE MODE]

You can switch to the desired picture mode suitable for the image source and the environment in which the projector is used.

- 1) Press ▲▼ to select [PICTURE MODE].
- 2) Press ◀▶ or the <ENTER> button.
  - The [PICTURE MODE] individual adjustment screen is displayed.
- 3) Press ◀▶ to switch the item.
  - The items will switch each time you press the button.

[STANDARD]	The image becomes suitable for moving images in general.
[DYNAMIC]	The image becomes suitable for use in bright areas.
[DICOM SIM.]	The image becomes similar to that of DICOM Part 14 Grayscale Standard.
[BLACKBOARD]	The image becomes appropriate to project on a blackboard.
[WHITE BOARD]	The image becomes appropriate to project on a whiteboard.
[CINEMA]*1	The image becomes suitable for movie contents.
[NATURAL]*2	The image becomes appropriate to use in a dark room.

\*1 When movie signal is input

\*2 When still image signal is input

#### Note

- DICOM is an abbreviation of “Digital Imaging and COmmunication in Medicine” and is a standard for medical imaging devices. Although the DICOM name is used, the projector is not a medical device, and display images should not be used for medical purposes such as diagnosis.

### [CONTRAST]

You can adjust the contrast of the colors.

- 1) Press ▲▼ to select [CONTRAST].
- 2) Press ◀▶ or the <ENTER> button.
  - The [CONTRAST] individual adjustment screen is displayed.
- 3) Press ◀▶ to adjust the level.

Operation	Adjustment	Range of adjustment
Press ▶.	The screen becomes brighter.	-31 - +31
Press ◀.	The screen becomes darker.	

#### Attention

- When it is necessary to adjust [CONTRAST] and [BRIGHTNESS], adjust the [PICTURE] menu → [BRIGHTNESS] first.

### [BRIGHTNESS]

You can adjust the dark (black) part of the projected image.

- 1) Press ▲▼ to select [BRIGHTNESS].
- 2) Press ◀▶ or the <ENTER> button.
  - The [BRIGHTNESS] individual adjustment screen is displayed.
- 3) Press ◀▶ to adjust the level.

Operation	Adjustment	Range of adjustment
Press ▶.	Increases the brightness of the dark (black) parts of the screen.	-31 - +31
Press ◀.	Reduces the brightness of the dark (black) parts of the screen.	

## [COLOR]

You can adjust the color saturation of the projected image.

- 1) Press ▲▼ to select [COLOR].
- 2) Press ◀▶ or the <ENTER> button.
  - The [COLOR] individual adjustment screen is displayed.
- 3) Press ◀▶ to adjust the level.

Operation	Adjustment	Range of adjustment
Press ▶.	Deepens colors.	-31 - +31
Press ◀.	Weakens colors.	

## [TINT]

You can adjust the skin tone in the projected image.

- 1) Press ▲▼ to select [TINT].
- 2) Press ◀▶ or the <ENTER> button.
  - The [TINT] individual adjustment screen is displayed.
- 3) Press ◀▶ to adjust the level.

Operation	Adjustment	Range of adjustment
Press ▶.	Adjusts skin tone toward greenish color.	-31 - +31
Press ◀.	Adjusts skin tone toward reddish purple.	

## [COLOR TEMPERATURE]

You can switch the color temperature if the white areas of the projected image are bluish or reddish.

### Adjusting with color temperature

- 1) Press ▲▼ to select [COLOR TEMPERATURE].
- 2) Press ◀▶ or the <ENTER> button.
  - The [COLOR TEMPERATURE] individual adjustment screen is displayed.
- 3) Press ◀▶ to switch the item.
  - The items will switch each time you press the button.

[DEFAULT]	Factory default setting.
[USER]	Adjusts white balance as desired. Refer to "Adjusting desired white balance" (➔ page 85) for details.
[LOW]/[HIGH]	Select an item so that images become natural.

### Note

- [DEFAULT] cannot be selected when the [PICTURE] menu → [PICTURE MODE] is set to [DICOM SIM.].
- This item is fixed to [USER] when the [DISPLAY OPTION] menu → [COLOR ADJUSTMENT] is set to anything other than [OFF].

### Adjusting desired white balance

- 1) Press ▲▼ to select [COLOR TEMPERATURE].
- 2) Press ◀▶ or the <ENTER> button.
  - The [COLOR TEMPERATURE] individual adjustment screen is displayed.
- 3) Press ◀▶ to select [USER].
- 4) Press the <ENTER> button.
  - The [COLOR TEMPERATURE] screen is displayed.

- 5) Press ▲▼ to select [WHITE BALANCE].
- 6) Press the <ENTER> button.
  - The [WHITE BALANCE] screen is displayed.
- 7) Press ▲▼ to select [WHITE BALANCE HIGH] or [WHITE BALANCE LOW].
- 8) Press the <ENTER> button.
  - The [WHITE BALANCE HIGH] screen or the [WHITE BALANCE LOW] screen is displayed.
- 9) Press ▲▼ to select [RED], [GREEN], or [BLUE].
- 10) Press ◀▶ to adjust the level.

Item	Operation	Adjustment	Range of adjustment
[RED]	Press ▶.	Deepens red.	[WHITE BALANCE HIGH]: 0 - +255 (factory default is +255) [WHITE BALANCE LOW]: -127 - +127 (factory default is 0)
	Press ◀.	Weakens red.	
[GREEN]	Press ▶.	Deepens green.	
	Press ◀.	Weakens green.	
[BLUE]	Press ▶.	Deepens blue.	
	Press ◀.	Weakens blue.	

#### Note

- Adjust [COLOR TEMPERATURE] correctly. All colors will not be displayed properly unless adequate adjustment is made. If the adjustment does not look suitable, you can press the <DEFAULT> button on the remote control to return the setting for the selected item only to the factory default setting.

#### Changing the [USER] name

- 1) Press ▲▼ to select [COLOR TEMPERATURE].
- 2) Press ◀▶ or the <ENTER> button.
  - The [COLOR TEMPERATURE] individual adjustment screen is displayed.
- 3) Press ◀▶ to select [USER].
- 4) Press the <ENTER> button.
  - The [COLOR TEMPERATURE] screen is displayed.
- 5) Press ▲▼ to select [COLOR TEMPERATURE NAME CHANGE].
- 6) Press the <ENTER> button.
  - The [COLOR TEMPERATURE NAME CHANGE] screen is displayed.
- 7) Press ▲▼◀▶ to select the text, and press the <ENTER> button to enter the text.
- 8) Press ▲▼◀▶ to select [OK], and press the <ENTER> button.
  - The name set to color temperature is changed.

#### Note

- When a name is changed, display of [USER] is also changed.

#### [GAMMA]

You can switch gamma mode.

- 1) Press ▲▼ to select [GAMMA].
- 2) Press ◀▶ or the <ENTER> button.
  - The [GAMMA] individual adjustment screen is displayed.
- 3) Press ◀▶ to adjust the level.

Operation	Adjustment	Range of adjustment
Press ►.	The intermediate tone becomes brighter.	-8 - +7
Press ◀.	The intermediate tone becomes darker.	

## [DAYLIGHT VIEW]

You can correct the image to the optimal vividness even if it is projected under a bright light.

- 1) Press ▲▼ to select [DAYLIGHT VIEW].
- 2) Press ◀▶ or the <ENTER> button.
  - The [DAYLIGHT VIEW] individual adjustment screen is displayed.
- 3) Press ◀▶ to switch the item.
  - The items will switch each time you press the button.

[AUTO]	Detects the brightness of the installed environment by the luminance sensor, and automatically corrects the vividness of the image.
[OFF]	No correction.
[1]	Corrects the image to weaken vividness.
[2]	Corrects the image to medium vividness.
[3]	Corrects the image to high vividness.

### Note

- [AUTO] cannot be selected when the [PROJECTOR SETUP] menu → [FRONT/REAR] of [PROJECTION METHOD] is set to [REAR].
- The luminance may not be detected correctly when an object is placed on top of the projector, blocking the luminance sensor. In such a case, this function may not operate properly even if it is set to [AUTO].
- When the [PICTURE] menu → [PICTURE MODE] is set to [DICOM SIM.], the factory default value is [OFF].

## [SHARPNESS]

You can adjust the sharpness of the projected image.

- 1) Press ▲▼ to select [SHARPNESS].
- 2) Press ◀▶ or the <ENTER> button.
  - The [SHARPNESS] individual adjustment screen is displayed.
- 3) Press ◀▶ to adjust the level.

Operation	Adjustment	Range of adjustment
Press ►.	Contours become sharper.	0 - +15
Press ◀.	Contours become softer.	

## [NOISE REDUCTION]

You can reduce noises when the input image is degraded and noise is occurring in the image signal.

- 1) Press ▲▼ to select [NOISE REDUCTION].
- 2) Press ◀▶ or the <ENTER> button.
  - The [NOISE REDUCTION] individual adjustment screen is displayed.
- 3) Press ◀▶ to switch the item.
  - The items will switch each time you press the button.

[OFF]	No correction.
[1]	Slightly corrects the noise.
[2]	Moderately corrects the noise.
[3]	Strongly corrects the noise.

### Attention

- When this is set for an input signal with less noise, the image may look different from the original image. In such a case, set it to [OFF].

## [DYNAMIC CONTRAST]

Light adjustment of the light source is performed automatically according to the image to make the contrast optimum for the image.

- 1) Press ▲▼ to select [DYNAMIC CONTRAST].
- 2) Press ◀▶ or the <ENTER> button.
  - The [DYNAMIC CONTRAST] individual adjustment screen is displayed.
- 3) Press ◀▶ to switch the item.
  - The items will switch each time you press the button.

[OFF]	Disables the dynamic contrast function.
[1]	Adjusts the light source and compensates signals to a small extent.
[2]	Adjusts the light source and compensates signals to a large extent.

### Note

- When the [PROJECTOR SETUP] menu → [LightID] is set to [EXTERNAL CONTROL] or [INTERNAL ID], [DYNAMIC CONTRAST] is set to [OFF].

## [SYSTEM SELECTOR]

The projector will automatically detect the input signal, but you can set the system method manually when an unstable signal is input. Set the system method matching the input signal.

- 1) Press ▲▼ to select [SYSTEM SELECTOR].
- 2) Press the <ENTER> button.
- 3) Press ▲▼ to select a system format.
  - Available system formats vary depending on the input signal.

Terminal	System format	
<VIDEO IN> terminal	Select [AUTO], [NTSC], [NTSC4.43], [PAL], [PAL-M], [PAL-N], [SECAM], or [PAL60]. Select [AUTO] normally. ([AUTO] will automatically determine from [NTSC], [NTSC4.43], [PAL], [PAL-M], [PAL-N], [SECAM], or [PAL60].) Switch the setting to the appropriate TV signal format.	
<RGB 1 IN> terminal, <RGB 2 IN> terminal	480/60i, 576/50i, or 576/50p signal	Select [RGB] or [Y <sub>C</sub> B <sub>R</sub> C <sub>R</sub> ].
	640 x 480/60 or 480/60p signal	Select [640x480/60], [480/60p Y <sub>C</sub> B <sub>R</sub> C <sub>R</sub> ], or [480/60p RGB].
	Other moving image signals	Select [RGB] or [Y <sub>P</sub> B <sub>P</sub> R <sub>R</sub> ].
<HDMI 1 IN> terminal, <HDMI 2 IN> terminal, <DIGITAL LINK/LAN> terminal	480/60i, 576/50i, 480/60p, or 576/50p signal	Select [AUTO], [RGB], or [Y <sub>C</sub> B <sub>R</sub> C <sub>R</sub> ].
	Other moving image signals	Select [AUTO], [RGB], or [Y <sub>P</sub> B <sub>P</sub> R <sub>R</sub> ].

- 4) Press the <ENTER> button.

### Note

- For details of the types of video signals that can be used with the projector, refer to “List of compatible signals” (➔ page 217).
- This may not function properly for some connected external devices.



## [POSITION] menu

On the menu screen, select [POSITION] from the main menu, and select an item from the sub-menu. Refer to “Navigating through the menu” (➔ page 79) for the operation of the menu screen.

### Note

- When the optional DIGITAL LINK output supported device (Model No.: ET-YFB100G, ET-YFB200G) is connected to the <DIGITAL LINK/ LAN> terminal, adjust the shift, aspect, and clock phase from the menu of DIGITAL LINK output supported device at first.

### [SHIFT]

Move the image position vertically or horizontally if the image projected on the screen is still out of position even when the positions of the projector and screen are correct.

- Press ▲▼ to select [SHIFT].
- Press the <ENTER> button.
  - The [SHIFT] screen is displayed.
- Press ▲▼◀▶ to adjust the position.

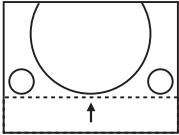
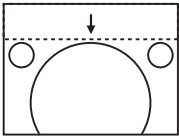
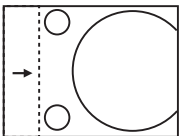
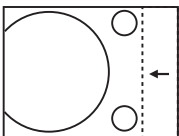
Orientation	Operation	Adjustment	
Vertical (up and down) adjustment	Press ▲.	The image position moves up.	
	Press ▼.	The image position moves down.	
Horizontal (right and left) adjustment	Press ▶.	The image position moves to the right.	
	Press ◀.	The image position moves to the left.	

### Note

- For the portrait setting, image position is moved horizontally when “Vertical (up and down) adjustment” is made. Image position is moved vertically when “Horizontal (right and left) adjustment” is made.
- [SHIFT] cannot be adjusted when the input is MEMORY VIEWER, Panasonic APPLICATION, or MIRRORING.

### [ASPECT]

You can switch the aspect ratio of the image.

The aspect ratio is switched within the screen range selected in the [DISPLAY OPTION] menu → [SCREEN SETTING] → [SCREEN FORMAT]. Set [SCREEN FORMAT] first. (➔ page 100)

- Press ▲▼ to select [ASPECT].
- Press ◀▶ or the <ENTER> button.
  - The [ASPECT] individual adjustment screen is displayed.
- Press ◀▶ to switch the item.
  - The items will switch each time you press the button.

[NORMAL]	Displays images without changing the aspect ratio of the input signals.
----------	---

[VID AUTO]*1	Identifies the video ID (VID) embedded in the video signal, and automatically switches the image size between 4:3 and 16:9. This is enabled when NTSC signal is input.
[NATIVE]	Displays images without changing the resolution of the input signals.
[WIDE]	Display images by converting the aspect ratio to 16:9 when the standard signal is input*2. When wide signal is input*3, the images are displayed with the input aspect ratio.
[4:3]	Displays images with the input aspect ratio when the standard signal is input*2. When the wide signal is input*3, the images are displayed with the input signal but reduced to fit into the 4:3 screen.
[H FIT]	Displays images using the entire width of the screen range selected in [SCREEN FORMAT]. When signals have the aspect ratio vertically longer than the screen aspect ratio selected in [SCREEN FORMAT], the images are displayed with the top and bottom parts cut off.
[V FIT]	Displays images using the entire height of the screen range selected in [SCREEN FORMAT]. When signals have the aspect ratio horizontally longer than the aspect ratio of the screen selected in [SCREEN FORMAT], the images are displayed with the right and left parts cut off.
[FULL]	Displays images in the entire screen range selected in [SCREEN FORMAT]. When the aspect ratio of the input signals differs from that of the screen range, the images are displayed with the aspect ratio converted to that of the screen selected in [SCREEN FORMAT].

\*1 Only when video signal (NTSC) is input

\*2 Standard signals are input signals with an aspect ratio of 4:3 or 5:4.

\*3 Wide-screen signals are input signals with an aspect ratio of 16:10, 16:9, 15:9 or 15:10.

### Note

- Some size modes are not available for certain types of input signals. In case of video signal (NTSC), [NORMAL] cannot be selected.
- If an aspect ratio which is different from the aspect ratio for the input signals is selected, the images will appear differently from the originals. Be careful of this when selecting the aspect ratio.
- If using the projector in places such as cafes or hotels to display programs for a commercial purpose or for public presentation, note that adjusting the aspect ratio or using the zoom function to change the screen images may be an infringement of the rights of the original copyright owner for that program under copyright protection laws. Take care when using a function of the projector such as the aspect ratio adjustment and zoom function.
- If conventional (normal) 4:3 images which are not wide-screen images are displayed on a wide screen, the edges of the images may not be visible or they may become distorted. Such images should be viewed as with an aspect ratio of 4:3 in the original format intended by the creator of the images.
- [ASPECT] cannot be set when the input is MEMORY VIEWER, Panasonic APPLICATION, or MIRRORING.

### [ZOOM]

You can adjust the image size.

The adjustments in [ZOOM] will differ depending on the setting of the [POSITION] menu → [ASPECT].

#### When [ASPECT] is set to other than [NORMAL] and [NATIVE]

- 1) Press ▲▼ to select [ZOOM].
- 2) Press the <ENTER> button.
  - The [ZOOM] screen is displayed.
- 3) Press ▲▼ to select [INTERLOCKED].
- 4) Press ◀▶ to switch the item.

[OFF]	Sets the [VERTICAL] and [HORIZONTAL] zoom ratio.
[ON]	Uses [BOTH] to set zoom ratio. Image can be enlarged or reduced vertically and horizontally at the same magnification.

- 5) Press ▲▼ to select [VERTICAL] or [HORIZONTAL].
  - If [ON] is selected, select [BOTH].
- 6) Press ◀▶ to adjust.

### Note

- When the [POSITION] menu → [ASPECT] is set to [NATIVE], [ZOOM] cannot be adjusted.
- [ZOOM] cannot be adjusted when the input is MEMORY VIEWER, Panasonic APPLICATION, or MIRRORING.

#### When [ASPECT] is set to [NORMAL]

- 1) Press ▲▼ to select [ZOOM].

- 2) Press the <ENTER> button.
  - The [ZOOM] screen is displayed.
- 3) Press ▲▼ to select [MODE].
- 4) Press ◀▶ to switch the item.

[INTERNAL]	Enlarges the size within the aspect range set with [SCREEN FORMAT].
[FULL]	Enlarges or reduces the size using the entire display area set with [SCREEN FORMAT].

- 5) Press ▲▼ to select [INTERLOCKED].
- 6) Press ◀▶ to switch the item.

[OFF]	Sets the [VERTICAL] and [HORIZONTAL] zoom ratio.
[ON]	Uses [BOTH] to set zoom ratio. Image can be enlarged or reduced vertically and horizontally at the same magnification.

- 7) Press ▲▼ to select [VERTICAL] or [HORIZONTAL].
  - If [ON] is selected, select [BOTH].
- 8) Press ◀▶ to adjust.

**Note**

- When the [POSITION] menu → [ASPECT] is set to anything other than [NORMAL], [MODE] is not displayed.
- [ZOOM] cannot be adjusted when the input is MEMORY VIEWER, Panasonic APPLICATION, or MIRRORING.

**[CLOCK PHASE]**

You can adjust the image to achieve an optimal image when there is a flickering image or smeared outlines.

- 1) Press ▲▼ to select [CLOCK PHASE].
- 2) Press ◀▶ or the <ENTER> button.
  - The [CLOCK PHASE] individual adjustment screen is displayed.
- 3) Press ◀▶ to adjust.
  - Adjustment value will change between [0] and [+31]. Adjust the image so that the amount of interference is at a minimum.

**Note**

- Adjustment may not be possible depending on the signal.
- There may be no optimal value if the output from the input computer is unstable.
- There may be no optimal value when the total dot number is shifted.
- [CLOCK PHASE] can be adjusted only when the YC<sub>B</sub>C<sub>R</sub>/YP<sub>B</sub>P<sub>R</sub> signal or the analogRGB signal is input to the <RGB 1 IN> terminal or the <RGB 2 IN> terminal.
- [CLOCK PHASE] cannot be adjusted when a digital signal is input.
- The adjustment value will change to [0] when ▶ is pressed while it was at [+31]. Also, the adjustment value will change to [+31] when ◀ is pressed while it was at [0].

**[REALTIME KEYSTONE]**

The keystone distortion that occurs when the projector is installed tilted is adjusted automatically.

- 1) Press ▲▼ to select [REALTIME KEYSTONE].
- 2) Press ◀▶ to select the item to adjust.

[OFF]	The real-time keystone distortion correction function is not executed automatically.
[ON]	The real-time keystone distortion correction function is executed automatically.

**Note**

- The keystone distortion may not be corrected fully depending on the installation condition. In such case, adjust it with the [POSITION] menu → [SCREEN ADJUSTMENT].
- [REALTIME KEYSTONE] cannot be set in following cases.
  - When the [PROJECTOR SETUP] menu → [PROJECTION METHOD] → [FLOOR/CEILING] is set to [CEILING]

- When the [PROJECTOR SETUP] menu → [PROJECTION METHOD] → [FLOOR/CEILING] is set to [AUTONEGOTIATION], and the actual installation status is ceiling mount
- When [REALTIME KEYSTONE] and [SCREEN ADJUSTMENT] are both set to [OFF] and [REALTIME KEYSTONE] is changed to [ON], [SCREEN ADJUSTMENT] is changed to [KEYSTONE].

## [SCREEN ADJUSTMENT]

You can correct various types of distortion in a projected image.



Unique image processing technology enables projection of a square image on a special screen shape.

- 1) Press ▲▼ to select [SCREEN ADJUSTMENT].
- 2) Press ◀▶ to switch the item.
  - The items will switch each time you press the button.

[OFF]	Does not perform [SCREEN ADJUSTMENT].
[KEYSTONE]	Adjusts any trapezoidal distortion in the projected image.
[CORNER CORRECTION]	Adjusts any distortion in the four corners of the projected image.
[CURVED CORRECTION]	Adjusts any curved distortion in the projected image.

## Setting [KEYSTONE] or [CURVED CORRECTION]

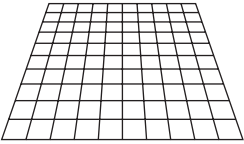
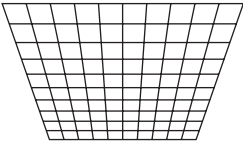
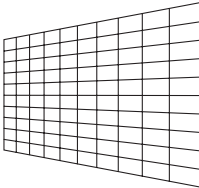
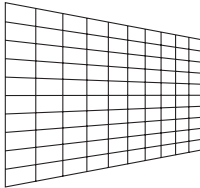
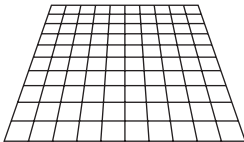
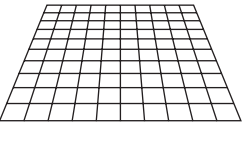
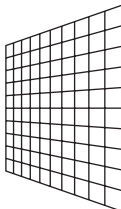
- 1) Press ▲▼ to select [SCREEN ADJUSTMENT].
- 2) Press ◀▶ to select [KEYSTONE] or [CURVED CORRECTION].
- 3) Press the <ENTER> button.
  - The [KEYSTONE] or [CURVED CORRECTION] screen is displayed.
- 4) Press ▲▼ to select the item to adjust.
- 5) Press ◀▶ to adjust.

[KEYSTONE]	
<p><b>[LENS THROW RATIO]</b> Set the throw ratio. Select the value close to the actual projection distance divided by projected image width here. For details of the projection distance and the projected image width, refer to “Projected image and throw distance” (➔ page 37).</p>	
<p><b>[VERTICAL KEYSTONE]</b></p> <div style="display: flex; justify-content: space-around; align-items: center;">   </div>	<p><b>[HORIZONTAL KEYSTONE]</b></p> <div style="display: flex; justify-content: space-around; align-items: center;">   </div>
<p><b>[VERTICAL BALANCE]</b></p> <div style="display: flex; justify-content: space-around; align-items: center;">   </div> <p>Adjust the setting according to the lens shift range in the vertical direction.</p>	<p><b>[HORIZONTAL BALANCE]</b></p> <div style="display: flex; justify-content: space-around; align-items: center;">   </div> <p>Adjust the setting according to the lens shift range in the horizontal direction.</p>

[CURVED CORRECTION]
<p><b>[LENS THROW RATIO]</b> Set the throw ratio. Select the value close to the actual projection distance divided by projected image width here. For details of the projection distance and the projected image width, refer to “Projected image and throw distance” (➔ page 37).</p>

[CURVED CORRECTION]			
[VERTICAL KEYSTONE]		[HORIZONTAL KEYSTONE]	
[VERTICAL ARC]		[HORIZONTAL ARC]	
[VERTICAL BALANCE]		[HORIZONTAL BALANCE]	
[MAINTAIN ASPECT RATIO] Select [ON] to correct while keeping the aspect ratio.			

### Setting [CORNER CORRECTION]

- 1) Press ▲▼ to select [SCREEN ADJUSTMENT].
- 2) Press ◀▶ to select [CORNER CORRECTION].
- 3) Press the <ENTER> button.
  - The [CORNER CORRECTION] screen is displayed.
- 4) Press ▲▼ to select the item to adjust.
- 5) Press the <ENTER> button.
  - The individual adjustment screen for the selected item is displayed.
- 6) Press ▲▼◀▶ to adjust.
  - Press ▲▼ to adjust [VERTICAL], and press ◀▶ to adjust [HORIZONTAL].
  - For the adjustment of [VERTICAL], press ▲ to adjust the value in – direction, and press ▼ to adjust the value in + direction.

[UPPER LEFT] [UPPER RIGHT] [LOWER LEFT] [LOWER RIGHT]	
--	--

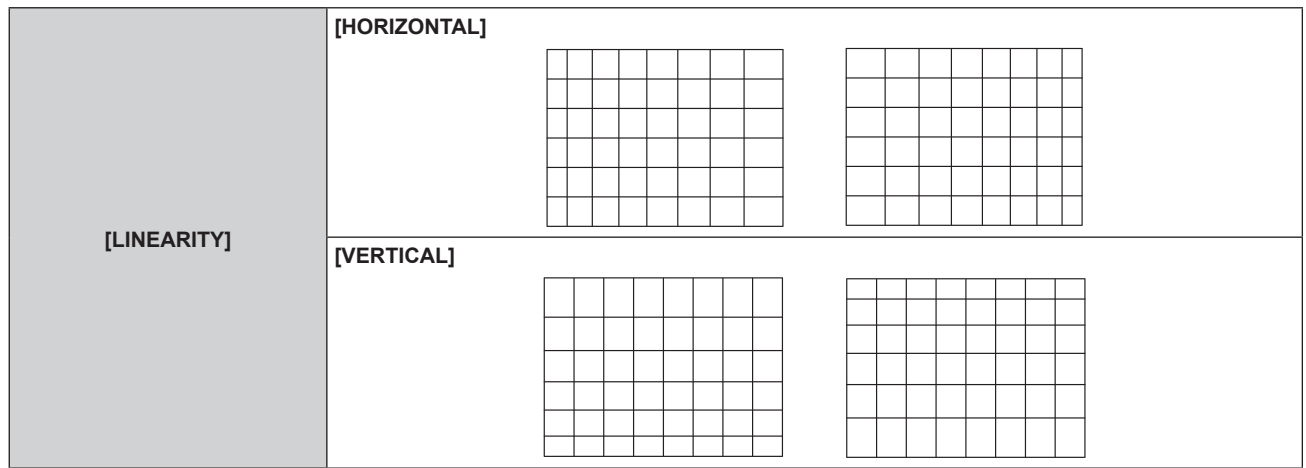

---

---

**Note**

- Depending on the correction value, the aspect ratio of the image may change.

## [ADVANCED MENU] menu

On the menu screen, select [ADVANCED MENU] from the main menu, and select an item from the sub-menu.

Refer to “Navigating through the menu” (➔ page 79) for the operation of the menu screen.

### [DIGITAL CINEMA REALITY]

You can increase the vertical resolution and enhance the picture quality by performing cinema processing when the PAL (or SECAM) 576i signal, the NTSC 480i signal, and 1080/50i, 1080/60i are input.

- 1) Press ▲▼ to select [DIGITAL CINEMA REALITY].
- 2) Press ◀▶ to switch the item.
  - The items will switch each time you press the button.

[AUTO]	Automatically detects the signal and performs the cinema processing. (Factory default setting)	
[OFF]	Does not perform cinema processing.	
[30p FIXED]	When 480i or 1080/60i signal is input	Performs forced cinema processing (2:2 pull-down).
[25p FIXED]	When 576i or 1080/50i signal is input	

#### Note

- In [DIGITAL CINEMA REALITY], the picture quality will degrade when a signal other than the 2:2 pull-down is set as [25p FIXED] or [30p FIXED]. (Vertical resolution will degrade.)

### [BLANKING]

You can adjust the blanking width if there are noises at the edge of the screen or the image is slightly running out from the screen while an image from the VCR or other devices are projected.

- 1) Press ▲▼ to select [BLANKING].
- 2) Press the <ENTER> button.
  - The [BLANKING] adjustment screen is displayed.
- 3) Press ▲▼ to select [UPPER], [LOWER], [LEFT], or [RIGHT].
- 4) Press ◀▶ to adjust the blanking width.

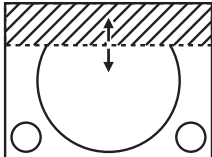
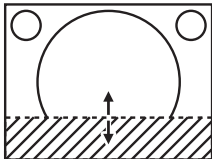
Blanking correction	Item	Operation	Adjustment	Range of adjustment	
Top of the screen	[UPPER]	Press ◀.	The blanking zone moves upward.		PT-MZ670, PT-MZ570: Top and bottom 0 - 599 PT-MW630, PT-MW530: Top and bottom 0 - 399
		Press ▶.	The blanking zone moves downward.		
Bottom of the screen	[LOWER]	Press ▶.	The blanking zone moves upward.		
		Press ◀.	The blanking zone moves downward.		

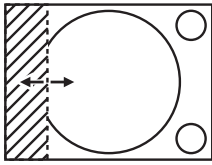
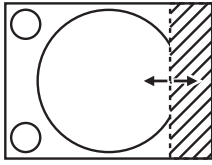
Blanking correction	Item	Operation	Adjustment	Range of adjustment	
Left side of the screen	[LEFT]	Press ▶.	The blanking zone moves to the right.		PT-MZ670, PT-MZ570: Left and right 0 - 959 PT-MW630, PT-MW530: Left and right 0 - 639
		Press ◀.	The blanking zone moves to the left.		
Right side of the screen	[RIGHT]	Press ◀.	The blanking zone moves to the right.		
		Press ▶.	The blanking zone moves to the left.		

**Note**

- [BLANKING] cannot be adjusted when the input is MEMORY VIEWER, Panasonic APPLICATION, or MIRRORING.

**[INPUT RESOLUTION]**

You can adjust the image to achieve an optimal image when there is a flickering image or smeared outlines.

- 1) Press ▲▼ to select [INPUT RESOLUTION].
- 2) Press the <ENTER> button.
  - The [INPUT RESOLUTION] screen is displayed.
- 3) Press ▲▼ to select [TOTAL DOTS], [DISPLAY DOTS], [TOTAL LINES], or [DISPLAY LINES], and press ◀▶ to adjust each item.
  - Values corresponding to the signal being input are displayed automatically for each item. Increase or decrease the displayed values and adjust to the optimal point while viewing the screen if there are vertical stripes or sections are missing from the screen.

**Note**

- Previously mentioned vertical banding will not occur with all white signal input.
- Image may be disrupted during automatic adjustment, but this is not a malfunction.
- [INPUT RESOLUTION] can be adjusted only when a RGB signal is input to the <RGB 1 IN> terminal or the <RGB 2 IN> terminal.
- Adjustment may not be possible depending on the signal.

**[CLAMP POSITION]**

You can adjust the optimal point when the black part of the image is blunt or it has turned green.

- 1) Press ▲▼ to select [CLAMP POSITION].
- 2) Press ◀▶ to adjust.

Status	Rough guide for optimal value	Range of adjustment
The black part is blunt.	The point where bluntness of the black part improves the most is the optimal value.	1 - 255
The black part is green.	The point where the green part becomes black, and the bluntness has improved is the optimal value.	

**Note**

- [CLAMP POSITION] can be adjusted only when a signal is input to the <RGB 1 IN> terminal or the <RGB 2 IN> terminal.
- Adjustment may not be possible depending on the signal.



## [RASTER POSITION]

---

This will allow the position of the image to move within the display area arbitrarily when the input image is not using the whole display area.

- 1) Press ▲▼ to select [RASTER POSITION].
- 2) Press the <ENTER> button.
  - The [RASTER POSITION] screen is displayed.
- 3) Press ▲▼◀▶ to adjust the position.

---

### Note

- [RASTER POSITION] cannot be adjusted when the input is MEMORY VIEWER, Panasonic APPLICATION, or MIRRORING.

## [DISPLAY LANGUAGE] menu

On the menu screen, select [DISPLAY LANGUAGE] from the main menu, and display the sub-menu. Refer to “Navigating through the menu” (➔ page 79) for the operation of the menu screen.

### Changing the display language

You can select the language of the on-screen display.

1) Press ▲▼◀▶ to select the display language and press the <ENTER> button.

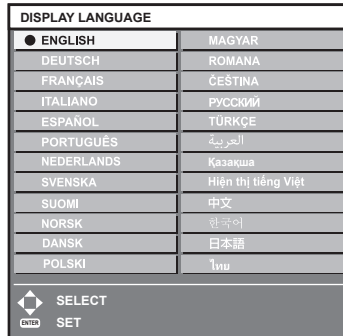

- Various menus, settings, adjustment screens, control button names, etc., are displayed in the selected language.
- The language can be switched to English, German, French, Italian, Spanish, Portuguese, Dutch, Swedish, Finnish, Norwegian, Danish, Polish, Hungarian, Romanian, Czech, Russian, Turkish, Arabic, Kazakh, Vietnamese, Chinese, Korean, Japanese, and Thai.

### Note

- The on-screen display language is set to English in the factory default setting as well as when the [PROJECTOR SETUP] menu → [INITIALIZE] → [ALL USER DATA] is executed.

## [DISPLAY OPTION] menu

On the menu screen, select [DISPLAY OPTION] from the main menu, and select an item from the sub-menu.

Refer to “Navigating through the menu” (➔ page 79) for the operation of the menu screen.

### [COLOR ADJUSTMENT]

Correct the color difference between projectors when using multiple projectors simultaneously.

- 1) Press ▲▼ to select [COLOR ADJUSTMENT].
- 2) Press ◀▶ to switch the item.
  - The items will switch each time you press the button.

[OFF]	Does not perform the color adjustment.
[3COLORS]	Adjusts the three colors [RED], [GREEN], or [BLUE] and the white [GAIN].
[7COLORS]	Adjusts the seven colors [RED], [GREEN], [BLUE], [CYAN], [MAGENTA], [YELLOW], or [WHITE].

- 3) Select [3COLORS] or [7COLORS], and press the <ENTER> button.
  - The [3COLORS] or [7COLORS] screen is displayed.
- 4) Press ▲▼ to select [RED], [GREEN], [BLUE], or [WHITE] ([RED], [GREEN], [BLUE], [CYAN], [MAGENTA], [YELLOW], or [WHITE] when [7COLORS] is selected).
- 5) Press the <ENTER> button.
  - The [3COLORS:RED], [3COLORS:GREEN], [3COLORS:BLUE], or [3COLORS:WHITE] screen is displayed.  
When [7COLORS] is selected, the [7COLORS:RED], [7COLORS:GREEN], [7COLORS:BLUE], [7COLORS:CYAN], [7COLORS:MAGENTA], [7COLORS:YELLOW], or [7COLORS:WHITE] screen is displayed.
  - By setting [AUTO TESTPATTERN] to [ON], the test pattern for the selected color is displayed.
- 6) Press ▲▼ to select [RED], [GREEN], or [BLUE].
  - Only [GAIN] can be adjusted when [WHITE] is selected for [3COLORS].
- 7) Press ◀▶ to adjust.
  - The adjustment value will change between 0\*1 and 2 048.

\*1 The lower limit varies depending on the color to be adjusted.

#### Note

- Operation when correcting the adjustment color  
When the correction color same as the adjustment color is changed: The luminance of the adjustment color changes.  
When correction color red is changed: Red is added to or subtracted from the adjustment color.  
When correction color green is changed: Green is added to or subtracted from the adjustment color.  
When correction color blue is changed: Blue is added to or subtracted from the adjustment color.
- Since advanced skills are necessary for the adjustment, this adjustment should be carried out by a person who is familiar with the projector or by a service person.
- Set [AUTO TESTPATTERN] to [ON] to automatically display a test pattern for use in adjusting the selected adjustment colors.
- Pressing the <DEFAULT> button on the remote control will restore the factory default settings for all items.
- When [COLOR ADJUSTMENT] is set to anything other than [OFF], the [DISPLAY OPTION] menu → [COLOR CORRECTION] is fixed to [OFF], and the [PICTURE] menu → [COLOR TEMPERATURE] is fixed to [USER].

### [COLOR CORRECTION]

Colors can be adjusted and registered for each input signal format.

- 1) Press ▲▼ to select [COLOR CORRECTION].
- 2) Press ◀▶ to switch the item.
  - The items will switch each time you press the button.

[OFF]	Standard setting
[USER]	For each of the four signal formats of VIDEO, RGB, and YC <sub>B</sub> C <sub>R</sub> /YP <sub>B</sub> P <sub>R</sub> , six colors of red, green, blue, cyan, magenta, and yellow can be adjusted and registered. Press the <ENTER> button and set the details. Adjustment is possible within the range of -31 to +31.

**[SCREEN SETTING]**

Set the screen size.

Correct to the optimum image position for the set screen when the aspect ratio of a projected image is changed. Set as necessary for the screen in use.

- 1) Press ▲▼ to select [SCREEN SETTING].
- 2) Press the <ENTER> button.
  - The [SCREEN SETTING] screen is displayed.
- 3) Press ◀▶ to switch the [SCREEN FORMAT] item.
  - The items will switch each time you press the button.

Model No.	[SCREEN FORMAT]	Range when [SCREEN POSITION] is selected
PT-MZ670 PT-MZ570	[16:10]	Cannot be adjusted.
	[4:3]	Adjusts the horizontal position between -160 and 160.
	[16:9]	Adjusts the vertical position between -60 and 60.
PT-MW630 PT-MW530	[16:10]	Cannot be adjusted.
	[4:3]	Adjusts the horizontal position between -107 and 107.
	[16:9]	Adjusts the vertical position between -40 and 40.

- 4) Press ▲▼ to select [SCREEN POSITION].
  - [SCREEN POSITION] cannot be selected or adjusted when [SCREEN FORMAT] is set to [16:10].
- 5) Press ◀▶ to adjust [SCREEN POSITION].

**[AUTO SIGNAL]**

Set whether to execute automatic setup of signals automatically.

The screen display position or signal level can be adjusted automatically without pressing the <AUTO SETUP/ CANCEL> button on the remote control on each occasion if you input unregistered signals frequently at meetings, etc.

- 1) Press ▲▼ to select [AUTO SIGNAL].
- 2) Press ◀▶ to switch the item.
  - The items will switch each time you press the button.

[OFF]	Sets the auto signal function to off.
[ON]	Executes automatic setup automatically when images are changed to unregistered signals during projection.

**[AUTO SETUP]**

Set this function when adjusting a special signal for still image signal, or horizontally long (such as 16:9) signal.

**Setting with [MODE]**

- 1) Press ▲▼ to select [AUTO SETUP].
- 2) Press the <ENTER> button.
  - The [AUTO SETUP] screen is displayed.
- 3) Press ▲▼ to select [MODE].
- 4) Press ◀▶ to switch the item.
  - The items will switch each time you press the button.

[DEFAULT]	Standard setting.
[WIDE]	Select this item when an image aspect ratio is a wide-screen signal, which does not meet the [DEFAULT] setting.
[USER]	Select this when receiving a signal with a special horizontal resolution (number of display dots).

- Proceed to Step 7) when [DEFAULT] or [WIDE] is selected.

- Proceed to Step 5) when [USER] is selected.
- 5) Press ▲▼ to select [DISPLAY DOTS], and press ◀▶ to match [DISPLAY DOTS] to the horizontal resolution of the signal source.
  - 6) Press ▲▼ to select [MODE].
  - 7) Press the <ENTER> button.
    - Automatic adjustment is executed. [PROGRESS] is displayed while in automatic adjustment. When completed, the screen returns to the [AUTO SETUP] screen.

### Adjusting position automatically

- 1) Press ▲▼ to select [AUTO SETUP].
- 2) Press the <ENTER> button.
  - The [AUTO SETUP] screen is displayed.
- 3) Press ▲▼ to select [POSITION ADJUST].
- 4) Press ◀▶ to switch the item.

[ON]	Adjust the screen position and size when automatic setup is executed.
[OFF]	Does not perform automatic adjustment.

### Note

- The automatic setup function may not operate properly unless a still image containing clear blacks and whites is input.

### [RGB IN]

Set the <RGB 1 IN> terminal and the <RGB 2 IN> terminal.

### Switching the slice level of an input synchronization signal

- 1) Press ▲▼ to select [RGB IN].
- 2) Press the <ENTER> button.
  - The [RGB IN] screen is displayed.
- 3) Press ▲▼ to select [SYNC SLICE LEVEL] for [RGB1] or [RGB2].
- 4) Press ◀▶ to switch the item.

[LOW]	Set the slice level to [LOW].
[HIGH]	Set the slice level to [HIGH].

### Setting [EDID MODE] in [RGB IN] (RGB2 input)

- 1) Press ▲▼ to select [RGB IN].
- 2) Press the <ENTER> button.
  - The [RGB IN] screen is displayed.
- 3) Press ▲▼ to select [EDID MODE] for [RGB2].
- 4) Press the <ENTER> button.
  - The [EDID MODE] screen is displayed.
- 5) Press ◀▶ to switch the item.
  - The items will switch each time you press the button.

[DEFAULT]	Standard setting.
[SCREEN FIT]	Changes the EDID data according to the [SCREEN FORMAT] setting.
[USER]	Sets the [RESOLUTION] and [VERTICAL SCAN FREQUENCY] items as EDID.

- Proceed to Step 10) when [DEFAULT] or [SCREEN FIT] is selected.
- 6) **Press the <ENTER> button.**
    - The [RESOLUTION] screen is displayed.
  - 7) **Press ▲▼◀▶ to select [RESOLUTION].**
    - Select [1024x768p], [1280x720p], [1280x768p], [1280x800p], [1280x1024p], [1366x768p], [1400x1050p], [1440x900p], [1600x900p], [1600x1200p], [1680x1050p], [1920x1080p], [1920x1080i], or [1920x1200p].
  - 8) **Press the <ENTER> button.**
    - The [VERTICAL SCAN FREQUENCY] screen is displayed.
  - 9) **Press ◀▶ to select [VERTICAL SCAN FREQUENCY].**
    - Select [60Hz], [50Hz], [30Hz], [25Hz], or [24Hz] when [1920x1080p] is selected for [RESOLUTION].
    - Select [60Hz], [50Hz], or [48Hz] when [1920x1080i] is selected for [RESOLUTION].
    - Select [60Hz] or [50Hz] when anything other than following is selected for [RESOLUTION].
      - [1920x1080p], [1920x1080i]
  - 10) **Press the <ENTER> button.**
    - The confirmation screen is displayed.
  - 11) **Press ◀▶ to select [OK], and press the <ENTER> button.**

#### Note

- The content set in [RESOLUTION] and [VERTICAL SCAN FREQUENCY] is displayed in the [RGB IN] screen.
- Setting of the resolution and the vertical scanning frequency may be necessary on the computer or video device in use.
- The computer, video device, or projector in use may require the power to be turned off and on again after setting.
- The output with the set resolution or vertical scanning frequency may not be possible depending on the computer or video device in use.

### [HDMI IN]

Set this item in accordance with the video signal input to the <HDMI 1 IN> terminal or the <HDMI 2 IN> terminal.

#### Setting [SIGNAL LEVEL] in [HDMI IN]

- 1) **Press ▲▼ to select [HDMI IN].**
- 2) **Press the <ENTER> button.**
  - The [HDMI IN] screen is displayed.
- 3) **Press ▲▼ to select [SIGNAL LEVEL] of [HDMI1] or [HDMI2].**
- 4) **Press ◀▶ to switch the item.**
  - The items will switch each time you press the button.

[AUTO]	Automatically sets the signal level.
[64-940]	Select this item when the signal output from the HDMI terminal of the external device (such as a Blu-ray disc player) is input to the <HDMI 1 IN> terminal or the <HDMI 2 IN> terminal.
[0-1023]	Select this item when the signal output from the DVI-D terminal of the external device (such as a computer) is input to the <HDMI 1 IN> terminal or the <HDMI 2 IN> terminal using a conversion cable, etc. Select this item also when the signal output from the HDMI terminal of a computer, etc., is input to the <HDMI 1 IN> terminal or the <HDMI 2 IN> terminal.

#### Note

- The optimal setting varies depending on the output setting of the connected external device. Refer to the operating instructions of the external device regarding the output of the external device.
- The HDMI signal level is displayed for 30 bits of input.

#### Setting [EDID MODE] in [HDMI IN]

- 1) **Press ▲▼ to select [HDMI IN].**
- 2) **Press the <ENTER> button.**
  - The [HDMI IN] screen is displayed.

- 3) Press ▲▼ to select [EDID MODE] of [HDMI1] or [HDMI2].
- 4) Press the <ENTER> button.
  - The [HDMI1] screen or the [HDMI2] screen is displayed.
- 5) Press ◀▶ to switch the item.
  - The items will switch each time you press the button.

[DEFAULT]	Standard setting.
[SCREEN FIT]	Changes the EDID data according to the [SCREEN FORMAT] setting.
[USER]	Set the [RESOLUTION] and [VERTICAL SCAN FREQUENCY] items as EDID.

- Proceed to Step 10) when [DEFAULT] or [SCREEN FIT] is selected.
- 6) Press the <ENTER> button.
    - The [RESOLUTION] screen is displayed.
  - 7) Press ▲▼◀▶ to select [RESOLUTION].
    - Select [1024x768p], [1280x720p], [1280x768p], [1280x800p], [1280x1024p], [1366x768p], [1400x1050p], [1440x900p], [1600x900p], [1600x1200p], [1680x1050p], [1920x1080p], [1920x1080i], or [1920x1200p].
  - 8) Press the <ENTER> button.
    - The [VERTICAL SCAN FREQUENCY] screen is displayed.
  - 9) Press ◀▶ to select [VERTICAL SCAN FREQUENCY].
    - Select [60Hz], [50Hz], [30Hz], [25Hz], or [24Hz] when [1920x1080p] is selected for [RESOLUTION].
    - Select [60Hz], [50Hz], or [48Hz] when [1920x1080i] is selected for [RESOLUTION].
    - Select [60Hz] or [50Hz] when anything other than following is selected for [RESOLUTION].
      - [1920x1080p], [1920x1080i]
  - 10) Press the <ENTER> button.
    - The confirmation screen is displayed.
  - 11) Press ◀▶ to select [OK], and press the <ENTER> button.

**Note**

- Settings in [RESOLUTION] and [VERTICAL SCAN FREQUENCY] are displayed in the [HDMI IN] screen.
- Setting of the resolution and the vertical scanning frequency may be necessary on the computer or video device in use.
- The computer, video device, or projector in use may require the power to be turned off and on again after setting.
- The output with the set resolution or vertical scanning frequency may not be possible depending on the computer or video device in use.

**[DIGITAL LINK IN]**

Set this item in accordance with the video signal input to the <DIGITAL LINK/LAN> terminal.

**Setting [SIGNAL LEVEL] in [DIGITAL LINK IN]**

- 1) Press ▲▼ to select [DIGITAL LINK IN].
- 2) Press the <ENTER> button.
  - The [DIGITAL LINK IN] screen is displayed.
- 3) Press ▲▼ to select [SIGNAL LEVEL].
- 4) Press ◀▶ to switch the item.
  - The items will switch each time you press the button.

[AUTO]	Automatically sets the signal level.
[64-940]	Select this item when the signal output from the HDMI terminal of an external device (Blu-ray disc player, etc.) is input to the <DIGITAL LINK/LAN> terminal via a twisted-pair-cable transmitter.
[0-1023]	Select this item when the signal output from the DVI-D terminal or HDMI terminal of an external device (such as a computer) is input to the <DIGITAL LINK/LAN> terminal via a twisted-pair-cable transmitter.

**Note**

- The optimal setting varies depending on the output setting of the connected external device. Refer to the operating instructions of the external device regarding the output of the external device.
- The signal level is displayed for 30 bits of input.

**Setting [EDID MODE] in [DIGITAL LINK IN]**

- 1) Press ▲▼ to select [DIGITAL LINK IN].
- 2) Press the <ENTER> button.
  - The [DIGITAL LINK IN] screen is displayed.
- 3) Press ▲▼ to select [EDID MODE].
- 4) Press the <ENTER> button.
  - The [DIGITAL LINK] screen is displayed.
- 5) Press ◀▶ to switch the item.
  - The items will switch each time you press the button.

[DEFAULT]	Standard setting.
[SCREEN FIT]	Changes the EDID data according to the [SCREEN FORMAT] setting.
[USER]	Sets the [RESOLUTION] and [VERTICAL SCAN FREQUENCY] items as EDID.

- Proceed to Step 10) when [DEFAULT] or [SCREEN FIT] is selected.

- 6) Press the <ENTER> button.
  - The [RESOLUTION] screen is displayed.
- 7) Press ▲▼◀▶ to select [RESOLUTION].
  - Select [1024x768p], [1280x720p], [1280x768p], [1280x800p], [1280x1024p], [1366x768p], [1400x1050p], [1440x900p], [1600x900p], [1600x1200p], [1680x1050p], [1920x1080p], [1920x1080i], or [1920x1200p].
- 8) Press the <ENTER> button.
  - The [VERTICAL SCAN FREQUENCY] screen is displayed.
- 9) Press ◀▶ to switch [VERTICAL SCAN FREQUENCY].
  - Select [60Hz], [50Hz], [30Hz], [25Hz], or [24Hz] when [1920x1080p] is selected for [RESOLUTION].
  - Select [60Hz], [50Hz], or [48Hz] when [1920x1080i] is selected for [RESOLUTION].
  - Select [60Hz] or [50Hz] when anything other than following is selected for [RESOLUTION].
    - [1920x1080p], [1920x1080i]
- 10) Press the <ENTER> button.
  - The confirmation screen is displayed.
- 11) Press ◀▶ to select [OK], and press the <ENTER> button.

**Note**

- Settings in [RESOLUTION] and [VERTICAL SCAN FREQUENCY] are displayed in the [DIGITAL LINK IN] screen.
- Setting of the resolution and the vertical scanning frequency may be necessary on the computer or video device in use.
- The computer, video device, or projector in use may require the power to be turned off and on again after setting.
- The output with the set resolution or vertical scanning frequency may not be possible depending on the computer or video device in use.

**[ON-SCREEN DISPLAY]**

Set the on-screen display.

**Setting [OSD POSITION]**

Set the position of the menu screen (OSD).

- 1) Press ▲▼ to select [ON-SCREEN DISPLAY].
- 2) Press the <ENTER> button.
  - The [ON-SCREEN DISPLAY] screen is displayed.



- 3) Press ▲▼ to select [OSD POSITION].
- 4) Press ◀▶ to switch the item.
  - The items will switch each time you press the button.

[2]	Sets to the center left of the screen.
[3]	Sets to the bottom left of the screen.
[4]	Sets to the top center of the screen.
[5]	Sets to the center of the screen.
[6]	Sets to the bottom center of the screen.
[7]	Sets to the upper right of the screen.
[8]	Sets to the center right of the screen.
[9]	Sets to the bottom right of the screen.
[1]	Sets to the upper left of the screen.

### Setting [OSD SIZE]

(Only for PT-MZ670, PT-MZ570)  
Set the display size of the menu screen (OSD).

- 1) Press ▲▼ to select [ON-SCREEN DISPLAY].
- 2) Press the <ENTER> button.
  - The [ON-SCREEN DISPLAY] screen is displayed.
- 3) Press ▲▼ to select [OSD SIZE].
- 4) Press ◀▶ to switch the item.
  - The items will switch each time you press the button.

[NORMAL]	Select this item normally.
[DOUBLE]	Displays the menu screen in the font size double of when set to [NORMAL]. The size of the menu screen is doubled horizontally and vertically.

### Setting [OSD ROTATION]

Set the orientation of the menu screen (OSD).

- 1) Press ▲▼ to select [ON-SCREEN DISPLAY].
- 2) Press the <ENTER> button.
  - The [ON-SCREEN DISPLAY] screen is displayed.
- 3) Press ▲▼ to select [OSD ROTATION].
- 4) Press ◀▶ to switch the item.
  - The items will switch each time you press the button.

[OFF]	Does not rotate the screen.
[CLOCKWISE]	Rotates the screen by 90° clockwise.
[COUNTERCLOCKWISE]	Rotates the screen by 90° counterclockwise.

### Setting [OSD DESIGN]

Set the color of the menu screen (OSD).

- 1) Press ▲▼ to select [ON-SCREEN DISPLAY].
- 2) Press the <ENTER> button.
  - The [ON-SCREEN DISPLAY] screen is displayed.
- 3) Press ▲▼ to select [OSD DESIGN].
- 4) Press ◀▶ to switch the item.
  - The items will switch each time you press the button.

[1]	Sets the background color to light blue and and selection color to yellow.
[2]	Sets the background color to dark blue and the selection color to blue.
[3]	Sets the background color to gray and and selection color to white.
[4]	Sets the background color to green and and selection color to light green.
[5]	Sets the background color to brown and and selection color to pink.
[6]	Sets the background color to light brown and the selection color to skin tone.

### Setting [OSD MEMORY]

Set hold for the position of the menu screen (OSD) cursor.

- 1) Press ▲▼ to select [ON-SCREEN DISPLAY].
- 2) Press the <ENTER> button.
  - The [ON-SCREEN DISPLAY] screen is displayed.
- 3) Press ▲▼ to select [OSD MEMORY].
- 4) Press ◀▶ to switch the item.
  - The items will switch each time you press the button.

[ON]	Holds the cursor position.
[OFF]	Does not hold the cursor position.

#### Note

- Even if [ON] is set, the cursor position is not maintained when the power is turned off.

### Setting [INPUT GUIDE]

Set whether to display the input guide in the position set in [OSD POSITION].

Input guide is a screen to display information such as the currently selected input terminal name, signal name, memory number, etc.

- 1) Press ▲▼ to select [ON-SCREEN DISPLAY].
- 2) Press the <ENTER> button.
  - The [ON-SCREEN DISPLAY] screen is displayed.
- 3) Press ▲▼ to select [INPUT GUIDE].
- 4) Press ◀▶ to switch the item.
  - The items will switch each time you press the button.

[ON]	Displays the input guide.
[OFF]	Hides the input guide.

### Setting [WARNING MESSAGE]

Set the display/hide of the warning message.

- 1) Press ▲▼ to select [ON-SCREEN DISPLAY].
- 2) Press the <ENTER> button.
  - The [ON-SCREEN DISPLAY] screen is displayed.
- 3) Press ▲▼ to select [WARNING MESSAGE].
- 4) Press ◀▶ to switch the item.
  - The items will switch each time you press the button.

[ON]	Displays the warning message.
[OFF]	Hides the warning message.

**Note**

- When [OFF] is set, a warning message is not displayed on the projected image even if a warning condition such as [TEMPERATURE WARNING] is detected while using the projector.  
The message prompting to clean/replace the filter is also not displayed.

**[CLOSED CAPTION SETTING] (only when NTSC signal is input)**

Set closed captions.

**Selecting the closed caption display**

- 1) Press ▲▼ to select [CLOSED CAPTION SETTING].
- 2) Press the <ENTER> button.
  - The [CLOSED CAPTION SETTING] screen is displayed.
- 3) Press ▲▼ to select [CLOSED CAPTION].
- 4) Press ◀▶ to switch the item.
  - The items will switch each time you press the button.

[OFF]	Hides closed captions.
[ON]	Displays closed captions.

- Proceed to Step 5) when [ON] is selected.

- 5) When the confirmation screen is displayed, press ◀▶ to select [OK], and press the <ENTER> button.

**Setting the closed caption mode**

- 1) Press ▲▼ to select [CLOSED CAPTION SETTING].
- 2) Press the <ENTER> button.
  - The [CLOSED CAPTION SETTING] screen is displayed.
- 3) Press ▲▼ to select [MODE].
  - [MODE] cannot be selected when [CLOSED CAPTION] is set to [OFF].
- 4) Press ◀▶ to switch the item.
  - The items will switch each time you press the button.

[CC1]	Displays CC1 data.
[CC2]	Displays CC2 data.
[CC3]	Displays CC3 data.
[CC4]	Displays CC4 data.

**Note**

- Closed caption is a function that displays text information of video signals mainly used in North America. Captions may not be displayed depending on the connected devices or contents being played back.
- [CLOSED CAPTION SETTING] can be selected only when NTSC signal is input.
- If [CLOSED CAPTION] is set to [ON], brightness of images may change depending on the external devices compatible with closed caption function to be connected or contents to be used.
- If a closed caption signal of the selected mode is input, the security message set in the [SECURITY] menu → [DISPLAY SETTING] is not displayed.
- Closed captions are not displayed when the menu screen is displayed.

**[SIGNAL SEARCH]**

Enable/disable the signal search function.

If the signal search function is enabled, the input with input signal is automatically selected and projection is started when the projector is turned on. Also, when the currently selected input has no signal, the projector will automatically switch to the input with input signal when the <AUTO SETUP/CANCEL> button is pressed.

- 1) Press ▲▼ to select [SIGNAL SEARCH].

2) Press ◀▶ to switch the item.

- The items will switch each time you press the button.

[ON]	Enables the signal search function.
[OFF]	Disables the signal search function.

**Note**

- The signal search function does not operate when the input is Panasonic APPLICATION or MIRRORING.
- If the input is MEMORY VIEWER, this function will determine that there is an input signal when the USB memory is inserted in the <VIEWER/PAIRING> terminal.

**[BACK COLOR]**

Set the display of the projected screen when there is no signal input.

1) Press ▲▼ to select [BACK COLOR].

2) Press ◀▶ to switch the item.

- The items will switch each time you press the button.

[BLUE]	Displays the entire projection area in blue.
[BLACK]	Displays the entire projection area in black.
[DEFAULT LOGO]	Displays the Panasonic logo.
[USER LOGO]	Displays the image registered by the user.

**Note**

- To create and register the [USER LOGO] image, use "Logo Transfer Software". The software can be downloaded from the Panasonic website (<https://panasonic.net/cns/projector/>).

**[STARTUP LOGO]**

Set the logo display when the power is turned on.

1) Press ▲▼ to select [STARTUP LOGO].

2) Press ◀▶ to switch the item.

- The items will switch each time you press the button.

[DEFAULT LOGO]	Displays the Panasonic logo.
[USER LOGO]	Displays the image registered by the user.
[NONE]	Disables the startup logo display.

**Note**

- When [USER LOGO] is selected, the display of the startup logo will be kept for approximately 15 seconds.
- To create and register the [USER LOGO] image, use "Logo Transfer Software". The software can be downloaded from the Panasonic website (<https://panasonic.net/cns/projector/>).
- If the [PROJECTOR SETUP] menu → [ECO MANAGEMENT] → [QUICK STARTUP] is set to [ON], the startup logo is not displayed when projection starts before the specified time elapses after the projector enters the standby mode. The specified time is a time set in the [PROJECTOR SETUP] menu → [ECO MANAGEMENT] → [QUICK STARTUP] → [VALID PERIOD].

**[SHUTTER SETTING]**

Set the operation of the shutter function.

**Setting [FADE-IN] or [FADE-OUT]**

1) Press ▲▼ to select [SHUTTER SETTING].

2) Press the <ENTER> button.

- The [SHUTTER SETTING] screen is displayed.

3) Press ▲▼ to select [FADE-IN] or [FADE-OUT].

4) Press ◀▶ to switch the item.

Item		Adjustment
[FADE-IN] [FADE-OUT]	[OFF]	Does not set fade-in or fade-out.
	[0.5s] - [10.0s]	Sets the fade-in or fade-out time. Select an item from [0.5s] - [4.0s], [5.0s], [7.0s], or [10.0s]. [0.5s] - [4.0s] can be selected in increments of 0.5.

**Note**

- If the <SHUTTER> button on the remote control is pressed during fade-in or fade-out, the fade operation is canceled.
- Fade-in/fade-out is not performed on the audio. Audio is output or paused linked to the operation of the shutter function.

**Setting [STARTUP]**

Automatically enable/disable the shutter function (shutter: closed/open) when the power is turned on.

- 1) Press ▲▼ to select [SHUTTER SETTING].
- 2) Press the <ENTER> button.
  - The [SHUTTER SETTING] screen is displayed.
- 3) Press ▲▼ to select [STARTUP].
- 4) Press ◀▶ to switch the item.

[OPEN]	The projector goes into projection mode with the shutter function disabled (shutter: opened) when the power is turned on.
[CLOSE]	The projector goes into projection mode with the shutter function enabled (shutter: closed) when the power is turned on.

**Using the shutter function**

Image and audio is turned off when the projector is not used for a specific time.

- 1) Press ▲▼ to select [SHUTTER SETTING].
- 2) Press the <ENTER> button.
  - The [SHUTTER SETTING] screen is displayed.
- 3) Press ▲▼ to select [SHUTTER].
- 4) Press the <ENTER> button.
  - Press the <MENU> button or the <RETURN> button to clear.

**Note**

- The power indicator <ON (G)/STANDBY (R)> will blink slowly in green while the shutter function is in use (shutter: closed).
- To output audio while the shutter function is in use (shutter: closed), set the [PROJECTOR SETUP] menu → [AUDIO SETTING] → [IN SHUTTER] to [ON].

**[P-TIMER]**

Set and operate the presentation timer function.

**Setting the mode**

- 1) Press ▲▼ to select [P-TIMER].
- 2) Press the <ENTER> button.
  - The [P-TIMER] screen is displayed.
- 3) Press ▲▼ to select [MODE].
- 4) Press ◀▶ to switch the item.
  - The items will switch each time you press the button.

[COUNT UP]	Displays the elapsed time from when the count is started.
[COUNT DOWN]	Displays the remaining time against the time set in [TIMER].

## Setting the countdown timer

- 1) Press ▲▼ to select [P-TIMER].
- 2) Press the <ENTER> button.
  - The [P-TIMER] screen is displayed.
- 3) Press ▲▼ to select [TIMER].
- 4) Press ◀▶ to set the time.
  - The time can be set from 1 minute to 180 minutes in one-minute interval.
  - The factory default setting is 10 minutes.

### Note

- [TIMER] can be set when [MODE] is set to [COUNT DOWN].

## Using the presentation timer

- 1) Press ▲▼ to select [P-TIMER].
- 2) Press the <ENTER> button.
  - The [P-TIMER] screen is displayed.
- 3) Press ▲▼ to select an item, and press the <ENTER> button.

[START]	Starts the count.
[STOP]	Stops the count.
[RESTART]	Restarts the count.
[RESET]	Resets the count.
[EXIT]	Ends the presentation timer.

- Elapsed time or remaining time is displayed in the bottom right of the projected image when [START] or [RESTART] is selected.
- The elapsed time or remaining time when it was stopped is displayed in the bottom right of the projected image when [STOP] is selected.

### Note

- The presentation timer can be operated by the <P-TIMER> button on the remote control. (➡ page 75)
- The security message set in the [SECURITY] menu → [DISPLAY SETTING] (➡ page 135) is not displayed while the elapsed time or remaining time is displaying.
- The elapsed time or remaining time is not displayed while the menu screen is displayed.
- When [MODE] is set to [COUNT UP], the start time will be "000:00".
- When [MODE] is set to [COUNT DOWN], the start time will be the value set in [TIMER].
- The timer gauge will turn clockwise when set to [COUNT UP], and turn counterclockwise when set to [COUNT DOWN].

## [FREEZE]

The projected image is paused and audio is turned off regardless of the playback of the external device.

- 1) Press ▲▼ to select [FREEZE].
- 2) Press the <ENTER> button.
  - Press the <MENU> button or the <RETURN> button to clear.

### Note

- [FREEZE] is displayed on the screen when video is paused.
- Operation of [FREEZE] can also be performed with the <FREEZE> button on the remote control. (➡ page 72)

## [DIGITAL ZOOM]

(When RGB signal for still images, HDMI signal for still images, or DIGITAL LINK signal for still images is input. Or, when MEMORY VIEWER, Panasonic APPLICATION, or MIRRORING is input.)

- 1) Press ▲▼ to select [DIGITAL ZOOM].

- 2) **Press the <ENTER> button.**
  - The [DIGITAL ZOOM] individual adjustment screen is displayed.
- 3) **Press ◀▶ to adjust the magnification factor.**
  - The magnification factor can be adjusted from 1.0 times to 3.0 times in 0.1 intervals.
- 4) **Press the <ENTER> button.**
  - The move screen is displayed.
- 5) **Moving the enlargement area**
  - For details, refer to “Using the digital zoom function” (➔ page 74).

---

**Note**

---

- The digital zoom is canceled when the <AUTO SETUP/CANCEL> button on the remote control or the <LENS/CANCEL> button on the control panel is pressed while performing the digital zoom.
- The adjustment value of the digital zoom is canceled when the type of input signal is changed while performing the digital zoom.
- The freeze function is disabled while performing the digital zoom.
- The digital zoom will not operate in some of the still image signals.

## [PROJECTOR SETUP] menu

On the menu screen, select [PROJECTOR SETUP] from the main menu, and select an item from the sub-menu.

Refer to “Navigating through the menu” (➔ page 79) for the operation of the menu screen.

### [PROJECTOR ID]

The projector has an ID number setting function that can be used when multiple projectors are used side by side to enable simultaneous control or individual control via a single remote control.

- 1) Press ▲▼ to select [PROJECTOR ID].
- 2) Press ◀▶ to switch the item.
  - The items will switch each time you press the button.

[ALL]	Select this item when controlling projectors without specifying an ID number.
[1] - [64]	Select this item when specifying an ID number to control individual projector.

#### Note

- To specify an ID number for individual control, the ID number of a remote control must match the ID number of the projector.
- When the ID number is set to [ALL], the projector will operate regardless of the ID number specified during remote control or computer control.  
If multiple projectors are set up side by side with IDs set to [ALL], they cannot be controlled separately from the projectors with other ID numbers.
- Refer to “Setting ID number of the remote control” (➔ page 76) for how to set the ID number on the remote control.

### [PROJECTION METHOD]

Set the projection method in accordance with the installation status of the projector.

Change the [FRONT/REAR] setting when the screen display is inverted.

Change the [FLOOR/CEILING] setting when the screen display is upside down.

#### Setting [FRONT/REAR]

- 1) Press ▲▼ to select [FRONT/REAR] of [PROJECTION METHOD].
- 2) Press ◀▶ to switch the item.
  - The items will switch each time you press the button.

[FRONT]	Select this item when installing the projector in front of the screen.
[REAR]	Select this item when installing behind the screen (using translucent screen).

#### Setting [FLOOR/CEILING]

- 1) Press ▲▼ to select [FLOOR/CEILING] of [PROJECTION METHOD].
- 2) Press ◀▶ to switch the item.
  - The items will switch each time you press the button.

[AUTO]	Automatically detects the attitude of the projector by the built-in angle sensor. Set [AUTO] normally.
[FLOOR]	Select this item when installing the projector on a desk, etc.
[CEILING]	Select this item when installing the projector using the Ceiling Mount Bracket (optional). Projected image is inverted upside down.

#### Note

- For the range of installation attitude detected by the built-in angle sensor, refer to “Angle sensor” (➔ page 36).



**[ECO MANAGEMENT]**

Set [ECO MANAGEMENT] to reduce the power consumption and enhance the life of the light source.

**Setting [LIGHT POWER]**

- 1) Press ▲▼ to select [ECO MANAGEMENT].
- 2) Press the <ENTER> button.
  - The [ECO MANAGEMENT] screen is displayed.
- 3) Press ▲▼ to select [LIGHT POWER].
- 4) Press ◀▶ to switch the item.
  - The items will switch each time you press the button.

[NORMAL]	Set this item when high luminance is required. The light power is 100 % and the estimated runtime is approximately 20 000 hours*1.
[ECO]	The luminance will decrease compared to [NORMAL], but set this item to suppress the reduction in luminance against the runtime of the light source. The light power is 70 % and the estimated runtime is approximately 24 000 hours*1.
[QUIET]	Select this item to prioritize the operation with low noise. The light power is 70 % and the estimated runtime is approximately 20 000 hours*1.

\*1 The runtime is an estimation when the [PICTURE] menu → [DYNAMIC CONTRAST] is set to [2].

**Note**

- Under influences of characteristics of each light source, conditions of use, installation environment, etc., the runtime may be shorter than the estimation.
- Runtime is a time until the luminance of the light source to become about half when using the projector continuously. The runtime is just an estimate, and is not the warranty period.
- If the runtime exceeds 10 000 hours, replacement of the components inside the projector may be required. Consult your dealer for details.
- When anything other than [NORMAL] is set, the setting in the [PROJECTOR SETUP] menu → [LightID] is disabled, and this item is fixed to [OFF].

**Setting [AMBIENT LIGHT DETECTION]**

Sets if the [AMBIENT LIGHT DETECTION] function to adjust the light power depending on the brightness of the installed location is enabled or not.

- 1) Press ▲▼ to select [ECO MANAGEMENT].
- 2) Press the <ENTER> button.
  - The [ECO MANAGEMENT] screen is displayed.
- 3) Press ▲▼ to select [AMBIENT LIGHT DETECTION].
- 4) Press ◀▶ to switch the item.
  - The items will switch each time you press the button.

[OFF]	Disables the ambient light detection function.
[ON]	Enables the ambient light detection function.

**Note**

- The luminance may not be detected correctly when an object is placed on top of the projector, blocking the luminance sensor. In such a case, it may not operate properly even if [AMBIENT LIGHT DETECTION] is set to [ON].
- When the [PROJECTOR SETUP] menu → [LightID] is set to [EXTERNAL CONTROL] or [INTERNAL ID], [AMBIENT LIGHT DETECTION] is set to [OFF].

**Setting [SIGNAL DETECTION]**

Set if the [SIGNAL DETECTION] function to reduce the power of the light source during no signal is enabled or not.

- 1) Press ▲▼ to select [ECO MANAGEMENT].

- 2) Press the <ENTER> button.
  - The [ECO MANAGEMENT] screen is displayed.
- 3) Press ▲▼ to select [SIGNAL DETECTION].
- 4) Press ◀▶ to switch the item.
  - The items will switch each time you press the button.

[OFF]	Disables the [SIGNAL DETECTION] function.
[ON]	Enables the [SIGNAL DETECTION] function.

#### Note

- When the [PROJECTOR SETUP] menu → [LightID] is set to [EXTERNAL CONTROL] or [INTERNAL ID], [SIGNAL DETECTION] is set to [OFF].
- The [SIGNAL DETECTION] function will also operate during MEMORY VIEWER, MIRRORING, or Panasonic APPLICATION input. In the following cases, the projector will determine that there is no input signal.
  - MEMORY VIEWER input: USB memory is not inserted in the <VIEWER/PAIRING> terminal
  - MIRRORING input, Panasonic APPLICATION input: There is no connection from the computer, etc.

#### Setting [POWER MANAGEMENT]

This is a function to set the power of the projector to standby state or ready state automatically when there is no input signal for specific time. Selection of standby state or the ready state, and the time for the power management function to operate can be set.

- 1) Press ▲▼ to select [ECO MANAGEMENT].
- 2) Press the <ENTER> button.
  - The [ECO MANAGEMENT] screen is displayed.
- 3) Press ▲▼ to select [POWER MANAGEMENT].
- 4) Press ◀▶ to switch the item.
  - The items will switch each time you press the button.

[SHUT DOWN]	The countdown timer is displayed when the signal input is not present for 30 seconds, and the light source is turned off, and goes into standby after cooling when the time set in [TIMER] has elapsed.
[OFF]	Disables the power management function.
[READY]	The countdown timer is displayed when the signal input is not present for 30 seconds, and the light source is turned off, and goes into ready state after cooling when the time set in [TIMER] has elapsed. The light source will turn on and starts projection when a signal is input or the button is operated while in ready state.

- Proceed to Step 5) when anything other than [OFF] is selected.
- 5) Press the <ENTER> button.
    - The [POWER MANAGEMENT] screen is displayed.
  - 6) Press ◀▶ to set the time for [TIMER].
    - The setting time will switch each time you press the button.
    - The time for the power management function to operate can be set from 5 minutes to 120 minutes in five-minute interval.

#### Note

- The power management function will also operate in MEMORY VIEWER, MIRRORING, and Panasonic APPLICATION inputs. The condition to determine that there is no input signal is as follows.
  - MEMORY VIEWER input: USB memory is not attached to the <VIEWER/PAIRING> terminal
  - MIRRORING input, Panasonic APPLICATION input: There is no connection from the computer, etc.

#### Setting [STANDBY MODE]

Set the power consumption during standby and whether to enable the [QUICK STARTUP] function.

- 1) Press ▲▼ to select [ECO MANAGEMENT].

- 2) Press the <ENTER> button.
  - The [ECO MANAGEMENT] screen is displayed.
- 3) Press ▲▼ to select [STANDBY MODE].
- 4) Press ◀▶ to switch the item.
  - The items will switch each time you press the button.

[NORMAL]	Select this item when using the network function during standby.
[ECO]	Select this item to reduce power consumption during standby.

- Proceed to Step 5) when [NORMAL] is selected.

- 5) Press ▲▼ to select [QUICK STARTUP].
- 6) Press ◀▶ to switch the item.
  - The items will switch each time you press the button.

[OFF]	Disables the [QUICK STARTUP] function.
[ON]	Enables the [QUICK STARTUP] function until the specified time set in [VALID PERIOD] elapses after the projector enters the standby mode. The time until the projection starts after the power is turned on will be reduced during the period when the [QUICK STARTUP] function is valid.

- Proceed to Step 7) when [ON] is selected.

- 7) Press the <ENTER> button.
  - The [QUICK STARTUP] screen is displayed.
- 8) Press ◀▶ to switch [VALID PERIOD].
  - The items will switch each time you press the button.

[30MIN.]	Sets the time until the [QUICK STARTUP] function is disabled after the projector enters the standby mode.
[60MIN.]	
[90MIN.]	

**Note**

- When [STANDBY MODE] is set to [NORMAL], the network function can be used during standby.
- When [STANDBY MODE] is set to [ECO], the network function and the audio output function cannot be used during standby. Also, some RS-232C commands cannot be used.
- When [STANDBY MODE] is set to [ECO], it takes longer for the projection to start after the power is turned on, compared to when set to [NORMAL].
- [STANDBY MODE] is fixed to [NORMAL] when the [PROJECTOR SETUP] menu → [SCHEDULE] is set to [ON].
- [QUICK STARTUP] cannot be set when [STANDBY MODE] is set to [ECO].
- When [QUICK STARTUP] is set to [ON], the power consumption during standby becomes high during the period when the [QUICK STARTUP] function is valid.
- If [QUICK STARTUP] is set to [ON], the [QUICK STARTUP] function is disabled when the time set in [VALID PERIOD] elapses after the projector enters the standby mode. The startup time and power consumption will be the same as when [QUICK STARTUP] is set to [OFF].
- When [QUICK STARTUP] is set to [ON], the power indicator <ON (G)/STANDBY (R)> blinks in red while in the standby mode during the period when the [QUICK STARTUP] function is valid. When [IN STANDBY MODE] in [AUDIO SETTING] is set to [OFF], the power indicator <ON (G)/STANDBY (R)> will change to a red light when the specified time set in [VALID PERIOD] elapses after the projector enters the standby mode.
- When [QUICK STARTUP] is set to [ON], the period when the [QUICK STARTUP] function is valid will be added as the projector runtime.

**[LightID]**

Set the function to transmit the Light ID signal.

- 1) Press ▲▼ to select [LightID].
- 2) Press ◀▶ to switch the item.
  - The items will switch each time you press the button.

[OFF]	Disables the Light ID function. The Light ID signal is not transmitted.
-------	---

<b>[EXTERNAL CONTROL]</b>	Transmits the Light ID signal set by the user. Select this item when the Light ID signal transmitted by the projector is switched using the contents list distribution function or the Light ID control function of the “Multi Monitoring & Control Software”. To set the Light ID, it is necessary to purchase the Light ID. To purchase the Light ID, visit the Panasonic website ( <a href="https://panasonic.net/cns/LinkRay/">https://panasonic.net/cns/LinkRay/</a> ). The Light ID which the user has set is erased in following cases. • When the <MAIN POWER> switched is set to <OFF>
<b>[INTERNAL ID]</b>	Transmits the internal Light ID signal. The internal Light ID signal is linked to the Panasonic website ( <a href="https://panasonic.net/cns/projector/">https://panasonic.net/cns/projector/</a> ). When the Light ID is set while [LightID] is set to [INTERNAL ID], the Light ID signal set by the user is transmitted.

**Note**

- When the [PROJECTOR SETUP] menu → [ECO MANAGEMENT] → [LIGHT POWER] is set to anything other than [NORMAL], the [LightID] setting is disabled and fixed to [OFF].
- The light output is decreased when [LightID] is set to anything other than [OFF].  
When clogging of the filter is detected and the brightness of the light source is restricted, [LightID] will be fixed to [OFF].
- Following setting will be disabled and it will be fixed to [OFF] when [LightID] is set to anything other than [OFF].
  - The [PICTURE] menu → [DYNAMIC CONTRAST]
  - The [PROJECTOR SETUP] menu → [ECO MANAGEMENT] → [AMBIENT LIGHT DETECTION] and [SIGNAL DETECTION]
- To set the Light ID signal, use “Multi Monitoring & Control Software”. The software can be downloaded from the Panasonic website (<https://panasonic.net/cns/projector/>).
- When the [PROJECTOR SETUP] menu → [INITIALIZE] → [ALL USER DATA] is executed, the [LightID] setting is reset to the factory default.
- For details of the contents list distribution function and Light ID control function of “Multi Monitoring & Control Software”, refer to the Operating Instructions of “Multi Monitoring & Control Software”.
- The projected image may flicker when the Light ID signal is transmitted, but this is caused luminance change during the transmission of the Light ID, and it is not a malfunction.
- When clogging of the filter is detected and the brightness of the light source is restricted, the filter indicator <FILTER> lights up and [LightID] is set to [OFF], and the Light ID signal will not be transmitted. Set it again after cleaning the clogged filter.  
For details on how to solve the filter clogging, refer to “When an indicator lights up” (➡ page 196).

**[INITIAL STARTUP]**

Set the startup method when the <MAIN POWER> switch is set to <ON>.

- 1) Press ▲▼ to select [INITIAL STARTUP].
- 2) Press ◀▶ to switch the item.
  - The items will switch each time you press the button.

<b>[LAST MEMORY]</b>	Starts up the projector in the condition before the <MAIN POWER> switch is set to <OFF>.
<b>[STANDBY]</b>	Starts up the projector in standby.
<b>[ON]</b>	Starts projecting immediately.

**[STARTUP INPUT SELECT]**

Set the input when the projector is switched on to start projection.

- 1) Press ▲▼ to select [STARTUP INPUT SELECT].
- 2) Press the <ENTER> button.
  - The [STARTUP INPUT SELECT] screen is displayed.
- 3) Press ▲▼◀▶ to select the input, and press the <ENTER> button.

<b>[LAST USED]</b>	Keeps the input selected last.
<b>[RGB1]</b>	Sets the input to RGB1.
<b>[RGB2]</b>	Sets the input to RGB2.
<b>[VIDEO]</b>	Sets the input to VIDEO.
<b>[HDMI1]</b>	Sets the input to HDMI1.
<b>[HDMI2]</b>	Sets the input to HDMI2.
<b>[DIGITAL LINK]</b>	Sets the input to DIGITAL LINK.
<b>[MEMORY VIEWER]</b>	Sets the input to MEMORY VIEWER.
<b>[Panasonic APPLICATION]</b>	Sets the input to Panasonic APPLICATION.
<b>[MIRRORING]*1</b>	Sets the input to MIRRORING.

[INPUT1] - [INPUT10]<sup>\*2</sup>

Sets the input to DIGITAL LINK, and switches the input of the Panasonic twisted-pair-cable transmitter to the specified input.

\*1 [MIRRORING] is displayed when the optional Wireless Module (Model No.: ET-WM300) is attached.

\*2 When the optional DIGITAL LINK output supported device (Model No.: ET-YFB100G, ET-YFB200G) is connected to the projector, its input name is automatically reflected from [INPUT1] to [INPUT10]. When an item that does not reflect the input name is selected, it will be disabled.

## [DATE AND TIME]

Set the time zone, date, and time of the built-in clock of the projector.

### Setting the time zone

- 1) Press ▲▼ to select [DATE AND TIME].
- 2) Press the <ENTER> button.
  - The [DATE AND TIME] screen is displayed.
- 3) Press ▲▼ to select [TIME ZONE].
- 4) Press ◀▶ to switch [TIME ZONE].

### Setting the date and time manually

- 1) Press ▲▼ to select [DATE AND TIME].
- 2) Press the <ENTER> button.
  - The [DATE AND TIME] screen is displayed.
- 3) Press ▲▼ to select [ADJUST CLOCK].
- 4) Press the <ENTER> button.
  - The [ADJUST CLOCK] screen is displayed.
- 5) Press ▲▼ to select an item, and press ◀▶ to set the local date and time.
- 6) Press ▲▼ to select [APPLY], and press the <ENTER> button.
  - The setting of the date and time will be completed.

### Setting the date and time automatically

- 1) Press ▲▼ to select [DATE AND TIME].
- 2) Press the <ENTER> button.
  - The [DATE AND TIME] screen is displayed.
- 3) Press ▲▼ to select [ADJUST CLOCK].
- 4) Press the <ENTER> button.
  - The [ADJUST CLOCK] screen is displayed.
- 5) Press ▲▼ to select [NTP SYNCHRONIZATION], and press ◀▶ to change the setting to [ON].
- 6) Press ▲▼ to select [APPLY], and press the <ENTER> button.
  - The setting of the date and time will be completed.

### Note

- To set the date and time automatically, the projector must be connected to the network.
- If synchronization with the NTP server fails just after [NTP SYNCHRONIZATION] is set to [ON], [NTP SYNCHRONIZATION] will return to [OFF]. If [NTP SYNCHRONIZATION] is set to [ON] while the NTP server is not set, [NTP SYNCHRONIZATION] will return to [OFF].
- Access the projector via a web browser to set the NTP server. Refer to "[Adjust clock] page" (➔ page 169) for details.
- The [TIME ZONE] setting is reset to the factory default when the [PROJECTOR SETUP] menu → [INITIALIZE] → [ALL USER DATA] is executed. However, the date and time based on the local date and time setting (Coordinated Universal Time, UTC, Universal Time, Coordinated) will be maintained without being initialized.

**[SCHEDULE]**

Set the command execution schedule for each day of the week.

**Enabling/disabling the schedule function**

- 1) Press ▲▼ to select [SCHEDULE].
- 2) Press ◀▶ to switch the item.
  - The items will switch each time you press the button.

[OFF]	Disables the schedule function.
[ON]	Enables the schedule function. Refer to “How to assign a program” (➔ page 118) or “How to set a program” (➔ page 118) for how to set the schedule.

**Note**

- The [STANDBY MODE] setting will be forced to [NORMAL] when the [PROJECTOR SETUP] menu → [ECO MANAGEMENT] → [STANDBY MODE] is set to [ECO], and [SCHEDULE] is set to [ON]. Changing the setting to [ECO] is not available. The [STANDBY MODE] setting will not change back even when [SCHEDULE] is set to [OFF] in this condition.

**How to assign a program**

- 1) Press ▲▼ to select [SCHEDULE].
- 2) Press ◀▶ to select [ON], and press the <ENTER> button.
  - The [SCHEDULE] screen is displayed.
- 3) Select and assign a program to each day of week.
  - Press ▲▼ to select the day of week, and press ◀▶ to select a program number.
  - You can set the program from No.1 to No.7. “- -” indicates that the program number has not been set.

**How to set a program**

Set up to 16 commands to each program.

- 1) Press ▲▼ to select [SCHEDULE].
- 2) Press ◀▶ to select [ON], and press the <ENTER> button.
  - The [SCHEDULE] screen is displayed.
- 3) Press ▲▼ to select [PROGRAM EDIT].
- 4) Press ◀▶ to select a program number, and press the <ENTER> button.
- 5) Press ▲▼ to select a command number, and press the <ENTER> button.
  - You can change the page using ◀▶.
- 6) Press ▲▼◀▶ to select [TIME], and press the <ENTER> button.
  - The projector is in the adjustment mode (the time is blinking).
- 7) Press ◀▶ to select “hour” or “minute”, and press ▲▼ or the number (<0> - <9>) buttons to set a time, and then press the <ENTER> button.
- 8) Press ▲▼◀▶ to select [COMMAND].
- 9) Press the <ENTER> button.
  - The [COMMAND] detailed screen is displayed.
- 10) Press ▲▼ to select a [COMMAND].
  - For [COMMAND] which requires detailed settings, the items of the detailed settings will switch each time you press ◀▶.
  - When [INPUT] is selected, press the <ENTER> button, and then press ▲▼◀▶ to select the input to be set.

[COMMAND]	Detailed settings of [COMMAND]	Description
[POWER ON]	—	Switches on the projector.
[STANDBY]	—	Enters standby.
[QUICK STARTUP]	[ON]	Enables the function of the [PROJECTOR SETUP] menu → [ECO MANAGEMENT] → [QUICK STARTUP].
	[OFF]	Disables the function of the [PROJECTOR SETUP] menu → [ECO MANAGEMENT] → [QUICK STARTUP].
[SHUTTER]	[OPEN]	Disables the shutter function (shutter: open).
	[CLOSE]	Enables the shutter function (shutter: closed).
[INPUT]	[RGB1]	Switches the input to RGB1.
	[RGB2]	Switches the input to RGB2.
	[VIDEO]	Switches the input to VIDEO.
	[HDMI1]	Switches the input to HDMI1.
	[HDMI2]	Switches the input to HDMI2.
	[DIGITAL LINK]	Switches the input to DIGITAL LINK.
	[MEMORY VIEWER]	Switches the input to MEMORY VIEWER.
	[Panasonic APPLICATION]	Switches the input to Panasonic APPLICATION.
	[MIRRORING]*1	Switches the input to MIRRORING.
[INPUT1] - [INPUT10]*2	Switches the input to DIGITAL LINK, and switches the input of the Panasonic twisted-pair-cable transmitter to the specified input.	
[LIGHT POWER]	[NORMAL]	Prioritizes luminance.
	[ECO]	Controls the power to increase the life of the light source although the luminance is lower than that of [NORMAL].
	[QUIET]	Prioritizes the operation with less noise although the luminance is lower than that of [NORMAL].
[IN STANDBY MODE(AUDIO)]	[OFF]	Stops the audio output during standby.
	[ON]	Outputs the audio during standby.
[VOLUME]	[0] - [63]	Sets the volume.

\*1 [MIRRORING] is displayed when the optional Wireless Module (Model No.: ET-WM300) is attached.

\*2 When the optional DIGITAL LINK output supported device (Model No.: ET-YFB100G, ET-YFB200G) is connected to the projector, its input name is automatically reflected from [INPUT1] to [INPUT10]. When an item that does not reflect the input name is selected, it will be disabled.

#### 11) Press the <ENTER> button.

- The command is fixed and ● is displayed at the left of the selected command.
- After the command is fixed, press the <MENU> button to close the detailed setting screen.

#### 12) Press ▲▼◀▶ to select [STORE], and press the <ENTER> button.

#### Note

- To delete a command that has been already set, press the <DEFAULT> button on the remote control while the screen in Step 5) is displayed, or select [DELETE] at the screen in Step 6) and press the <ENTER> button.
- If multiple commands have been set for the same time, they are executed in chronological order starting from the smallest command number.
- The operating time will be the local time. (➔ page 117)
- If an operation is executed with the remote control or control panel of the projector or with a control command before the command set in [SCHEDULE] is executed, the command set with the schedule function may not be executed.

### [RS-232C]

Set the communication condition of the <SERIAL IN> terminal. Refer to “<SERIAL IN> terminal” (➔ page 213).

- 1) Press ▲▼ to select [RS-232C].
- 2) Press the <ENTER> button.
  - The [RS-232C] screen is displayed.
- 3) Press ▲▼ to select [INPUT SELECT].
- 4) Press ◀▶ to switch the item.

[PROJECTOR]	Performs the RS-232C communication with the <SERIAL IN> terminal of the projector.
[DIGITAL LINK]	Performs the RS-232C communication via the optional DIGITAL LINK output supported device (Model No.: ET-YFB100G, ET-YFB200G) and the <DIGITAL LINK/LAN> terminal.

5) Press ▲▼ to select [BAUDRATE].

6) Press ◀▶ to switch the item.

- The items will switch each time you press the button.

[9600]	Select the proper speed.
[19200]	
[38400]	

7) Press ▲▼ to select [PARITY].

8) Press ◀▶ to switch the item.

- The items will switch each time you press the button.

[NONE]	Select the parity condition.
[EVEN]	
[ODD]	

### Note

- When [INPUT SELECT] is set to [DIGITAL LINK], communication using that serial terminal is available only when the corresponding device (such as the optional DIGITAL LINK output supported device (Model No.: ET-YFB100G, ET-YFB200G)) is connected to the <DIGITAL LINK/LAN> terminal.
- When transferring logos via the optional DIGITAL LINK output supported device (Model No.: ET-YFB100G, ET-YFB200G), setting for “NO SIGNAL SLEEP” of the DIGITAL LINK output supported device should be set to “OFF” to avoid interruption of communication.
- When [INPUT SELECT] is set to [DIGITAL LINK], communication speed for input is fixed to 9 600 bps and the parity is fixed to “NONE”.

### Using the control command for the existing projector

Set this function when using the control command for previously purchased Panasonic projector to control this projector with a computer using the <SERIAL IN> terminal on the projector. The existing Panasonic projector control software, etc., can continually be used.

1) Press ▲▼ to select [RS-232C].

2) Press the <ENTER> button.

- The [RS-232C] screen is displayed.

3) Press ▲▼ to select [EMULATE].

4) Press the <ENTER> button.

- The [EMULATE] screen is displayed.

5) Press ▲▼ to select an item.

[OFF]	Does not use existing control command for the projector.
[D3500]	D3500 series
[D4000]	D4000 series
[D/W5k SERIES]	D5700 series, DW5100 series, D5600 series, DW5000 series, D5500 series
[D/W/Z6k SERIES]	DZ870 series, DW830 series, DX100 series, DZ780 series, DW750 series, DX820 series, DZ770 series, DW740 series, DX810 series, DZ680 series, DW640 series, DX610 series, DW730 series, DX800 series, DZ6710 series, DZ6700 series, DW6300 series, D6000 series, D5000 series, DZ570 series, DW530 series, DX500 series, RZ970 series, RW930 series, RX110 series, RZ770 series, RZ660 series, RW730 series, RW620 series, RZ670 series, RW630 series, RZ575 series, RZ570 series
[L730 SERIES]	L730 series, L720 series, L520 series
[L780 SERIES]	L780 series, L750 series
[L735 SERIES]	L735 series
[L785 SERIES]	L785 series
[F/W SERIES]	FW430 series, FX400 series, FW300 series, F300 series, F200 series, FW100 series, F100 series
[LZ370]	LZ370 series
[LB/W SERIES]	LB3 series, LB2 series, LB1 series, ST10 series, LB90 series, LW80NT series, LB80 series, LB78 series, LB75 series
[VX500 SERIES]	VW435N series, VW440 series, VW430 series, VX505N series, VX510 series, VX500 series, VW330 series, VX400NT series, VX400 series, VX41 series
[EZ570 SERIES]	EZ570 series, EW630 series, EW530 series, EX600 series, EX500 series



[VW431D]	VW431D series
----------	---------------

- 6) Press the <ENTER> button.
  - The confirmation screen is displayed.
- 7) Press ◀▶ to select [OK], and press the <ENTER> button.

### [REMOTE1 MODE]

Set the <REMOTE 1 IN> terminal.

- 1) Press ▲▼ to select [REMOTE1 MODE].
- 2) Press ◀▶ to switch the item.
  - The items will switch each time you press the button.

[DEFAULT]	Uses pin assignment of the <REMOTE 1 IN> terminal in standard setting.
[USER]	Use this item when changing the setting of the <REMOTE 1 IN> terminal. (➔ page 216)
[F/W SERIES]	Uses the <REMOTE 1 IN> terminal setting compatible with the F/W series.

- Proceed to Step 3) when [USER] is selected.

- 3) Press the <ENTER> button.
- 4) Press ▲▼ to select one from [PIN2] to [PIN8], and press ◀▶ to switch the setting.

### [FUNCTION BUTTON]

Set the function of the <FUNCTION> button on the remote control.

- 1) Press ▲▼ to select [FUNCTION BUTTON].
- 2) Press the <ENTER> button.
  - The [FUNCTION BUTTON] screen is displayed.
- 3) Press ▲▼ to select a function.

[DISABLE]	Disables the <FUNCTION> button.
[SUB MEMORY]	Displays the sub memory list. (➔ page 134)
[SYSTEM SELECTOR]	Switches the [SYSTEM SELECTOR] setting. (➔ page 88)
[DAYLIGHT VIEW]	Switches the [DAYLIGHT VIEW] setting. (➔ page 87)

- 4) Press the <ENTER> button.

### [LENS CALIBRATION]

Detect the lens shift limit value of the projector, and automatically set the home position.

- 1) Press ▲▼ to select [LENS CALIBRATION].
- 2) Press the <ENTER> button.
  - The confirmation screen is displayed.
- 3) Press ◀▶ to select [OK], and press the <ENTER> button.
  - To cancel, select [CANCEL].
  - The lens moves up, down, left, and right to detect the lens shift limit value, and automatically set the home position.
  - The lens stops to complete the lens calibration.

#### Note

- [PROGRESS] is displayed in the menu during lens calibration. The operation cannot be canceled during calibration.
- [INCOMPLETE] is displayed when the lens calibration was not executed correctly.
- Pressing the <FOCUS> button on the remote control for three seconds or longer will also display the confirmation screen for lens calibration execution.

**[AUDIO SETTING]**

Set audio functions in detail.

**Adjusting the volume**

- 1) Press ▲▼ to select [AUDIO SETTING].
- 2) Press the <ENTER> button.
  - The [AUDIO SETTING] screen is displayed.
- 3) Press ▲▼ to select [VOLUME].
- 4) Press ◀▶ to adjust the level.

Operation	Adjustment	Range of adjustment
Press ▶.	Increases the volume.	0 - 63
Press ◀.	Decreases the volume.	

**Adjusting the left to right audio balance**

- 1) Press ▲▼ to select [AUDIO SETTING].
- 2) Press the <ENTER> button.
  - The [AUDIO SETTING] screen is displayed.
- 3) Press ▲▼ to select [BALANCE].
- 4) Press ◀▶ to adjust the level.

Operation	Adjustment	Range of adjustment
Press ▶.	Increases the volume on the right.	L16 - R16
Press ◀.	Increases the volume on the left.	

**Setting the audio output of the built-in speaker**

- 1) Press ▲▼ to select [AUDIO SETTING].
- 2) Press the <ENTER> button.
  - The [AUDIO SETTING] screen is displayed.
- 3) Press ▲▼ to select [BUILT-IN SP].
- 4) Press ◀▶ to switch the item.
  - The items will switch each time you press the button.

[ON]	Outputs the audio from the built-in speaker.
[OFF]	Does not output the audio from the built-in speaker.

**Note**

- When [BUILT-IN SP] is set to [ON], audio is output from the built-in speaker even when a cable is connected to the <VARIABLE AUDIO OUT> terminal. To not output audio from the built-in speaker and output the audio from the external audio device connected to the <VARIABLE AUDIO OUT> terminal, set [BUILT-IN SP] to [OFF].

**Setting audio output in the standby mode**

- 1) Press ▲▼ to select [AUDIO SETTING].
- 2) Press the <ENTER> button.
  - The [AUDIO SETTING] screen is displayed.
- 3) Press ▲▼ to select [IN STANDBY MODE].

4) Press ◀▶ to switch the item.

- The items will switch each time you press the button.

[OFF]	Audio is not output during standby.
[ON]	Audio is output during standby.

**Note**

- Audio is not output in the standby mode when the [PROJECTOR SETUP] menu → [ECO MANAGEMENT] → [STANDBY MODE] is set to [ECO].

**Setting audio output while using the shutter function**

1) Press ▲▼ to select [AUDIO SETTING].

2) Press the <ENTER> button.

- The [AUDIO SETTING] screen is displayed.

3) Press ▲▼ to select [IN SHUTTER].

4) Press ◀▶ to switch the item.

- The items will switch each time you press the button.

[OFF]	Audio is not output while using the shutter function (shutter: closed).
[ON]	Audio is output while using the shutter function (shutter: closed).

**Setting mute mode**

1) Press ▲▼ to select [AUDIO SETTING].

2) Press the <ENTER> button.

- The [AUDIO SETTING] screen is displayed.

3) Press ▲▼ to select [MUTE].

4) Press ◀▶ to switch the item.

- The items will switch each time you press the button.

[OFF]	Audio is output.
[ON]	Audio is not output.

**Setting audio input from a connected device**

1) Press ▲▼ to select [AUDIO SETTING].

2) Press the <ENTER> button.

- The [AUDIO SETTING] screen is displayed.

3) Press ▲▼ to select item to set in [AUDIO IN SELECT].

[RGB1]	Sets the audio to output when RGB1 is input.
[RGB2]	Sets the audio to output when RGB2 is input.
[VIDEO]	Sets the audio to output when VIDEO is input.
[HDMI1]	Sets the audio to output when HDMI1 is input.
[HDMI2]	Sets the audio to output when HDMI2 is input.
[DIGITAL LINK]	Sets the audio to output when DIGITAL LINK is input.
[NETWORK/USB]	Sets the audio to output when MEMORY VIEWER, MIRRORING, or Panasonic APPLICATION is input.

4) Press ◀▶ to switch the item.

- The items will switch each time you press the button.

[AUDIO IN 1]	Audio connected to the <AUDIO IN 1> terminal is output during projection of image from the set input terminal.
[AUDIO IN 2]	Audio connected to the <AUDIO IN 2> terminal is output during projection of image from the set input terminal.
[AUDIO IN 3]	Audio connected to the <AUDIO IN 3> terminal is output during projection of image from the set input terminal.
[HDMI1 AUDIO IN] <sup>*1</sup>	Audio input to HDMI1 is output.
[HDMI2 AUDIO IN] <sup>*2</sup>	Audio input to HDMI2 is output.
[DIGITAL LINK AUDIO IN] <sup>*3</sup>	Audio input to DIGITAL LINK is output.
[NETWORK/USB AUDIO IN] <sup>*4</sup>	Outputs the audio of MEMORY VIEWER, MIRRORING, or Panasonic APPLICATION.

\*1 Only when the input signal is HDMI1

\*2 Only when the input signal is HDMI2

\*3 Only when the input signal is DIGITAL LINK

\*4 Only when the input signal is MEMORY VIEWER, MIRRORING, or Panasonic APPLICATION

## [FILTER COUNTER]

Check the runtime of the filter and set the cleaning/replacement cycle of the filter. Also, the runtime of the filter can be reset.

- 1) Press ▲▼ to select [FILTER COUNTER].
- 2) Press the <ENTER> button.
  - The [FILTER COUNTER] screen is displayed.

[FILTER COUNTER]	Displays the runtime of the filter.
[TIMER]	Sets the cleaning/replacement cycle of the filter.
[FILTER COUNTER RESET]	Resets the runtime of the filter.

## Setting [TIMER]

If the filter is to be cleaned/replaced periodically, set the cycle in hours. Once the runtime of the filter reaches the set time, a message prompting to clean/replace the filter [FILTER COUNTER has reached the set time.] is displayed on the projected image.

- 1) Press ▲▼ to select [FILTER COUNTER].
- 2) Press the <ENTER> button.
  - The [FILTER COUNTER] screen is displayed.
- 3) Press ▲▼ to select [TIMER].
- 4) Press ◀▶ to switch the item.
  - The items will switch each time you press the button.

[OFF]	Select this item when a message is not to be displayed.
[1000 H] - [20000 H]	Select this item when a message is to be displayed. The cleaning/replacement cycle of the filter can be set in 1 000 hour intervals.

## Resetting [FILTER COUNTER]

Reset the runtime of the filter.

- 1) Press ▲▼ to select [FILTER COUNTER].
- 2) Press the <ENTER> button.
  - The [FILTER COUNTER] screen is displayed.
- 3) Press ▲▼ to select [FILTER COUNTER RESET].
- 4) Press the <ENTER> button.
- 5) The confirmation screen is displayed, so press ◀▶ to select [OK], and press the <ENTER> button.
  - Display of [FILTER COUNTER] will change to [0 H].

## [DC OUT]

Set the power supply function of the <DC OUT> terminal.

- 1) Press ▲▼ to select [DC OUT].
- 2) Press ◀▶ to select an item.

[ON]	Enables the power supply function. Power is supplied to the external device connected to the <DC OUT> terminal.
[OFF]	Disables the power supply function. The power is not supplied even if an external device is connected to the <DC OUT> terminal.

### Note

- Power is not supplied in the standby condition even if it is set to [ON].
- When an external device exceeding the rating (DC 5 V, maximum 2 A) is connected to the <DC OUT> terminal while this function is set to [ON], an error is detected and the power supply will be stopped. At this time, [ERROR] is displayed in [DC OUT]. Disconnect the external drive and turn on the projector again when [ERROR] is displayed.

## [STATUS]

Display the status of the projector.

- 1) Press ▲▼ to select [STATUS].
- 2) Press the <ENTER> button.
  - The [STATUS] screen is displayed.
- 3) Press ◀▶ to switch the pages.
  - The page will change each time you press the button.

[PROJECTOR TYPE]	Displays the projector type and serial number of the projector.	
[SERIAL NUMBER]	Displays the serial number of the projector.	
[PROJECTOR RUNTIME]	Displays the runtime of the projector.	
[LIGHT RUNTIME]	Displays the runtime of the light source.	
[CONTINUOUS LIGHTING TIME]	Displays the elapsed time from when the light source is illuminated. The elapsed time after the illumination of the light source can be confirmed when adjusting the focus. The elapsed time is reset when the light source is temporarily turned off such as using the shutter function.	
[MAIN/SUB VERSION]	Displays the main and sub versions of the firmware of the projector.	
[NETWORK VERSION]	Displays the network version of the projector.	
[INTAKE AIR TEMP.] <sup>*1</sup>	Displays the status of the intake air temperature of the projector.	
[EXHAUST AIR TEMP.] <sup>*1</sup>	Displays the status of the exhaust air temperature of the projector.	
[LIGHT TEMP. 1] <sup>*1</sup>	Displays the temperature status for the front block of the light source (on the lens side).	
[LIGHT TEMP. 2] <sup>*1</sup>	Displays the temperature status for the rear block of the light source (on the air exhaust port side).	
[SELF TEST]	Displays the status of the projector.	
[INPUT]	Displays the input terminal currently selected.	
[SIGNAL NAME]	Displays the input signal name.	
[MEMORY NO.]	Displays the memory number of the input signal.	
[ON COUNT]	[POWER ON TIMES]	Displays the number of times the power is turned on.
[NUMBER OF REGISTERED SIGNAL]	Displays the number of registered signals.	
[COOLING CONDITION]	Displays the set cooling conditions.	
[ATMOSPHERIC PRESSURE]	Displays the atmospheric pressure.	
[REMOTE1 STATUS]	Displays the control status of the REMOTE1.	
[EMULATE]	Displays the setting in the [PROJECTOR SETUP] menu → [RS-232C] → [EMULATE].	

<b>[SIGNAL INFORMATION]</b>	<b>[INPUT]</b>	Displays the input terminal used for the projected image.
	<b>[SIGNAL FORMAT]</b>	Displays the format of the input signal.
	<b>[SIGNAL FREQUENCY]</b>	Displays the frequency of the input signal.
	<b>[SYNC.STATE]</b>	Displays the sync polarity of the input signal.
	<b>[V.SYNC WIDTH]</b>	Displays the vertical sync signal pulse width of the input signal.
	<b>[SCAN TYPE]</b>	Displays the scan type of the input signal.
	<b>[TOTAL DOTS]</b>	Displays the total dot count of the input signal.
	<b>[DISPLAY DOTS]</b>	Displays the number of input signal display dots.
	<b>[TOTAL LINES]</b>	Displays the total line count of the input signal.
	<b>[DISPLAY LINES]</b>	Displays the number of input signal display lines.
	<b>[SAMPLING]</b>	Displays the sampling information of the input signal.
	<b>[SIGNAL LEVEL]</b>	Displays the signal level of the input signal.

\*1 The temperature status is indicated with text color (green/yellow/red) and bar scale. Use the projector within the range that the indication is green.

### Note

- E-mail containing the status can be sent to the E-mail address (up to two addresses) set in “[E-mail set up] page” (➔ page 170) by pressing the <ENTER> button while the **[STATUS]** screen is displayed.
- There may be items that are displayed and items that are not displayed in [SIGNAL INFORMATION] depending on the setting or the input signal.
- If any abnormality has occurred on the projector, press the <DEFAULT> button while the **[STATUS]** screen is displayed to display the detail screen of the error information.
- For details on the contents displayed in [SELF TEST], refer to “[SELF TEST] display” (➔ page 206).

## [DATA CLONING]

The menu setting and adjustment values of one projector can be copied to multiple projectors via LAN or using the USB memory.

### ■ Data that cannot be copied

Following menu settings and adjustment values are not copied. Set these in each projector.

- Menu lock password
- Security password
- Control device password
- The [PROJECTOR SETUP] menu → [PROJECTOR ID]
- The [PROJECTOR SETUP] menu → [DATE AND TIME] → [ADJUST CLOCK]
- [NETWORK/USB] → [WIRED LAN]
- [NETWORK/USB] → [WIRELESS LAN]
- [NETWORK/USB] → [PROJECTOR NAME]
- The [PROJECTOR SETUP] menu → [DATA CLONING] → [LAN] → [WRITE PROTECT]
- Password set in “[Change password] page” (➔ page 174) of the web control screen
- “[E-mail set up] page” (➔ page 170) in the web control screen
- “[Authentication set up] page” (➔ page 171) in the web control screen
- “[Crestron Connected(TM)] page” (➔ page 175) in the web control screen

### ■ Supported device

- Commercially available USB memory is supported.  
The USB memory with a security function is not supported.
- Only the cards formatted in FAT16 or FAT32 can be used.
- Only the single partition structure is supported.

### Note

- The cloning function will not operate when the models of the projectors are different. Use between the same model.
- Set the input to anything other than MEMORY VIEWER, and then execute [DATA CLONING].
- When the data cloning function is used, the light source indicator <LIGHT>, the temperature indicator <TEMP>, and the filter indicator <FILTER> will blink while copying the data. Wait until the blinking of the indicator is stopped.

## Copying the data to other projector via LAN

Set the projector to copy the data as follows in advance.

- The [PROJECTOR SETUP] menu → [DATA CLONING] → [LAN] → [WRITE PROTECT] → [OFF]

- 1) **Connect all projectors to the hub using LAN cables. (⇒ page 154)**
- 2) **Turn on all the projectors.**
- 3) **Press ▲▼ to select [DATA CLONING].**
- 4) **Press the <ENTER> button.**
  - The [SECURITY PASSWORD] screen is displayed.
- 5) **Enter a security password and press the <ENTER> button.**
  - The [DATA CLONING] screen is displayed.
- 6) **Press ▲▼ to select [LAN].**
- 7) **Press the <ENTER> button.**
  - The [LAN DATA CLONING] screen is displayed.
- 8) **Press ▲▼ to select [SELECT PROJECTOR].**
- 9) **Press the <ENTER> button.**
  - The projector with the same subnet is displayed as a list.
- 10) **Press ▲▼ to select the projector to be the copy destination.**
- 11) **Press the <ENTER> button.**
  - To select multiple projectors, repeat Steps 10) to 11).
- 12) **Press the <DEFAULT> button on the remote control.**
  - The confirmation screen is displayed.
- 13) **Press ◀▶ to select [OK], and press the <ENTER> button.**
  - Copy of the data to the projector is started.  
Once the copy is completed, result is displayed in the [LAN DATA CLONING] screen.  
Meanings of the marks displayed in the list are as follows.
    - Green: Data copy has succeeded.
    - Red: Data copy has failed. Confirm the connection of the LAN cable and power status of the copy destination projector.
  - The copy destination projector will display the data cloning request message, transfer to standby mode automatically, and perform the copy of the data.
- 14) **Turn off the copy destination projector.**
  - The copied content is reflected in the copy destination projector.

#### Note

---

- The security password is the password set in the [SECURITY] menu → [SECURITY PASSWORD CHANGE].  
Initial password as the factory default: ▲▶▼◀▲▶▼◀
- 

#### Setting [WRITE PROTECT].

---

Set if the copy of data via LAN is permitted or not.

- 1) **Press ▲▼ to select [DATA CLONING].**
- 2) **Press the <ENTER> button.**
  - The [SECURITY PASSWORD] screen is displayed.
- 3) **Enter a security password and press the <ENTER> button.**
  - The [DATA CLONING] screen is displayed.
- 4) **Press ▲▼ to select [LAN].**
- 5) **Press the <ENTER> button.**
  - The [LAN DATA CLONING] screen is displayed.
- 6) **Press ▲▼ to select [WRITE PROTECT].**

7) Press ◀▶ to switch the item.

- The items will switch each time you press the button.

[OFF]	Operation of [DATA CLONING] from other projector via LAN is enabled.
[ON]	Operation of [DATA CLONING] from other projector via LAN is disabled. <ul style="list-style-type: none"> <li>• Copy will not be possible when set to [ON]. When it is not necessary to copy, set to [ON] so the data is not changed by mistake.</li> </ul>

**Note**

- The security password is the password set in the [SECURITY] menu → [SECURITY PASSWORD CHANGE].  
Initial password as the factory default: ▲▶▼◀▲▶▼◀

**Copying the data to other projector using USB**

**Copying projector data to USB memory**

- 1) Insert the USB memory into the <VIEWER/PAIRING> terminal.
- 2) Press ▲▼ to select [DATA CLONING].
- 3) Press the <ENTER> button.
  - The [SECURITY PASSWORD] screen is displayed.
- 4) Enter a security password and press the <ENTER> button.
  - The [DATA CLONING] screen is displayed.
- 5) Press ▲▼ to select [USB MEMORY].
- 6) Press the <ENTER> button.
  - The [SELECT COPY TYPE] screen is displayed.
- 7) Press ▲▼ to select [PROJECTOR -> USB MEMORY].
- 8) Press the <ENTER> button.
  - The confirmation screen is displayed.
- 9) Press ◀▶ to select [OK], and press the <ENTER> button.
  - Copying of data to the USB memory is started.  
Once the copying of data is completed, [Data copy finished.] is displayed.
- 10) Once the copying of the data is completed, disconnect the USB memory from the <VIEWER/PAIRING> terminal.

**Note**

- The security password is the password set in the [SECURITY] menu → [SECURITY PASSWORD CHANGE].  
Initial password as the factory default: ▲▶▼◀▲▶▼◀
- Depending on the type of the USB memory, it may not be able to connect by contacting the surrounding parts. In such case, copy the data via LAN. For details of copying the data via LAN, refer to "Copying the data to other projector via LAN" (► page 126).
- An error message is displayed when saving or reading to/from the USB memory has failed.

**Copying data in the USB memory to the projector**

- 1) Insert the USB memory into the <VIEWER/PAIRING> terminal.
- 2) Press ▲▼ to select [DATA CLONING].
- 3) Press the <ENTER> button.
  - The [SECURITY PASSWORD] screen is displayed.
- 4) Enter a security password and press the <ENTER> button.
  - The [DATA CLONING] screen is displayed.
- 5) Press ▲▼ to select [USB MEMORY].



- 6) Press the <ENTER> button.
  - The [SELECT COPY TYPE] screen is displayed.
- 7) Press ▲▼ to select [USB MEMORY -> PROJECTOR].
- 8) Press the <ENTER> button.
  - The confirmation screen is displayed.
- 9) Press ◀▶ to select [OK], and press the <ENTER> button.
  - Copying of the data from the USB memory is started, and the projector will go into standby mode.
- 10) Once the copying of the data is completed, disconnect the USB memory from the <VIEWER/PAIRING> terminal.
- 11) Turn off the power of the projector.
  - The copied content is reflected to the projector.

#### Note

- The security password is the password set in the [SECURITY] menu → [SECURITY PASSWORD CHANGE].  
Initial password as the factory default: ▲▶▼◀▲▶▼◀

### [SAVE ALL USER DATA]

Save the various setting values as a backup in the built-in memory of the projector.

- 1) Press ▲▼ to select [SAVE ALL USER DATA].
- 2) Press the <ENTER> button.
  - The [SECURITY PASSWORD] screen is displayed.
- 3) Enter a security password and press the <ENTER> button.
- 4) When the confirmation screen is displayed, press ◀▶ to select [OK], and press the <ENTER> button.
  - [PROGRESS] is displayed while saving data.

#### Note

- The security password is the password set in the [SECURITY] menu → [SECURITY PASSWORD CHANGE].  
Initial password as the factory default: ▲▶▼◀▲▶▼◀
- Data set from the computer application is not included in [ALL USER DATA].

### [LOAD ALL USER DATA]

Load the various setting values saved as a backup in the built-in memory of the projector.

- 1) Press ▲▼ to select [LOAD ALL USER DATA].
- 2) Press the <ENTER> button.
  - The [SECURITY PASSWORD] screen is displayed.
- 3) Enter a security password and press the <ENTER> button.
- 4) When the confirmation screen is displayed, press ◀▶ to select [OK], and press the <ENTER> button.

#### Note

- The security password is the password set in the [SECURITY] menu → [SECURITY PASSWORD CHANGE].  
Initial password as the factory default: ▲▶▼◀▲▶▼◀
- The projector enters the standby mode to reflect the setting values when [LOAD ALL USER DATA] is executed.
- Data registered from a computer is not included in [ALL USER DATA].

### [INITIALIZE]

Return various setting values to their factory default settings.

- 1) Press ▲▼ to select [INITIALIZE].
- 2) Press the <ENTER> button.
  - The [SECURITY PASSWORD] screen is displayed.

3) Enter a security password and press the <ENTER> button.

- The [INITIALIZE] screen is displayed.

4) Press ▲▼ to select an item to initialize.

[ALL USER DATA]	Returns all setting values including [REGISTERED SIGNAL], [NETWORK/E-MAIL], and [LOGO IMAGE] to the factory default settings. The projector enters the standby mode to reflect the setting values.
[REGISTERED SIGNAL]	Deletes all the setting values saved for each input signal. To delete only a part of a registered signal, perform the procedure described in “Deleting the registered signal” (► page 132).
[NETWORK/E-MAIL]	Returns the various setting values in the [NETWORK/USB] menu to the factory default values.
[LOGO IMAGE]	Deletes the image registered in [USER LOGO].

5) Press the <ENTER> button.

6) When the confirmation screen is displayed, press ◀▶ to select [OK], and press the <ENTER> button.

**Note**

- The security password is the password set in the [SECURITY] menu → [SECURITY PASSWORD CHANGE].  
Initial password as the factory default: ▲▶▼◀▲▶▼◀
- The following settings are not initialized even if [ALL USER DATA] is executed.
  - The [PROJECTOR SETUP] menu → [ECO MANAGEMENT] → [STANDBY MODE]

**[SERVICE PASSWORD]**

This function is used by a service person.

## [TEST PATTERN] menu

On the menu screen, select [TEST PATTERN] from the main menu.

Refer to “Navigating through the menu” (➔ page 79) for the operation of the menu screen.

### [TEST PATTERN]

Display the test pattern built-in to the projector.

Settings of position, size, and other factors will not be reflected in test patterns. Make sure to display the input signal before performing various adjustments.

#### 1) Press ◀▶ to switch the [TEST PATTERN] item.

- The items will switch each time you press the button.

Menu screen + Color bar (vertical)	Displays a test pattern with the menu screen. Select a desired test pattern.
Menu screen + Color bar (horizontal)	
Menu screen + 16 tones (vertical 1)	
Menu screen + 16 tones (vertical 2)	
Menu screen + 16 tones (horizontal 1)	
Menu screen + 16 tones (horizontal 2)	
Menu screen + Focus	
Menu screen + 16:9/4:3 aspect frame	
Menu screen + All white	
Menu screen + All black	
Menu screen + Input screen	Displays the menu screen and input signal. Internal test patterns are not displayed.

#### Note

- Press the <ON SCREEN> button on the remote control while the test pattern is displayed to hide the menu screen.

## [SIGNAL LIST] menu

On the menu screen, select [SIGNAL LIST] from the main menu.

Refer to “Navigating through the menu” (➔ page 79) for the operation of the menu screen.

### ■ Registered signal details

Memory number: A1 (1-2)



When the address number (A1, A2, ... L7, L8) signal is registered

- A name can be set for each sub memory (➔ page 134).

### Registering new signals

After a new signal is input and the <MENU> button on the remote control or the control panel is pressed, the registration is completed and the [MAIN MENU] screen is displayed.

#### Note

- Up to 96 signals, including sub memories, can be registered to the projector.
- There are 12 pages (eight memories of A through L, with eight memories possible on each page) for memory numbers, and the signal is registered to the lowest number that is available. If there is no available memory number it will be overwritten from the oldest signal.
- The name to be registered is automatically determined by the input signal.
- If a menu is being displayed, the new signals will be registered at the instant they are input.

### Renaming the registered signal

Registered signals can be renamed.

- 1) Press ▲▼◀▶ to select the signal of which name is to be changed.
- 2) Press the <ENTER> button.
  - The [REGISTERED SIGNAL STATUS] screen is displayed.
  - The memory number, input terminal, input signal name, frequency, synch polarity, etc., are displayed.
  - Press the <MENU> button to return to the [REGISTERED SIGNAL LIST] screen.
- 3) Press the <ENTER> button.
  - The [REGISTERED SIGNAL SETUP] screen is displayed.
- 4) Press ▲▼ to select [SIGNAL NAME CHANGE].
- 5) Press the <ENTER> button.
  - The [SIGNAL NAME CHANGE] screen is displayed.
- 6) Press ▲▼◀▶ to select the text, and press the <ENTER> button to enter the text.
- 7) After the name is changed, press ▲▼◀▶ to select [OK], and press the <ENTER> button.
  - The registration is completed and the [REGISTERED SIGNAL SETUP] screen returns.
  - When pressing ▲▼◀▶ to select [CANCEL] and pressing the <ENTER> button, the changed signal name will not be registered and an automatically registered signal name will be used.

### Deleting the registered signal

Registered signals can be deleted.

- 1) Press ▲▼◀▶ to select the signal to delete.
- 2) Press the <DEFAULT> button on the remote control.
  - The [REGISTERED SIGNAL DELETE] screen is displayed.
  - To cancel the deletion, press the <MENU> button to return to the [REGISTERED SIGNAL LIST] screen.
- 3) Press the <ENTER> button.
  - The selected signal will be deleted.

**Note**

- A registered signal can also be deleted from [REGISTERED SIGNAL DELETE] on the [REGISTERED SIGNAL SETUP] screen.

**Protecting the registered signal**

- 1) Press ▲▼◀▶ to select the signal to protect.
- 2) Press the <ENTER> button.
  - The [REGISTERED SIGNAL STATUS] screen is displayed.
- 3) Press the <ENTER> button.
  - The [REGISTERED SIGNAL SETUP] screen is displayed.
- 4) Press ▲▼ to select [LOCK].
- 5) Press ◀▶ to switch the item.
  - The items will switch each time you press the button.

[OFF]	The signal is not protected.
[ON]	The signal is protected.

- A lock icon is displayed at the right of the [REGISTERED SIGNAL LIST] screen when [LOCK] is set to [ON].

**Note**

- When [LOCK] is set to [ON], signal deletion, image adjustment, and automatic setup are not available. To perform these operations, set [LOCK] to [OFF].
- A signal can be registered to the sub memory even if it is protected.
- Even a protected signal will be deleted if [INITIALIZE] is executed.

**Expanding signal lock-in range**

- 1) Press ▲▼◀▶ to select the signal to set.
- 2) Press the <ENTER> button.
  - The [REGISTERED SIGNAL STATUS] screen is displayed.
- 3) Press the <ENTER> button.
  - The [REGISTERED SIGNAL SETUP] screen is displayed.
- 4) Press ▲▼ to select [LOCK-IN RANGE].
- 5) Press ◀▶ to switch the item.
  - The items will switch each time you press the button.

[NARROW]	Select this item usually.
[WIDE]	Widens the lock-in range.

- An expansion icon is displayed at the right of the [REGISTERED SIGNAL LIST] screen when [LOCK-IN RANGE] is set to [WIDE].

**Note**

- Switch the range where the signal to be input is determined to be the same signal as the already registered signal.
- To prioritize the determination that a signal is the same as the already registered signal, set this function to [WIDE].
- Use in cases such as when the synchronizing frequency of a signal to be input has changed slightly, or multiple signal lists are registered.
- This function can be used only when a signal is input from the <RGB 1 IN> terminal, the <RGB 2 IN> terminal, <HDMI 1 IN> terminal, the <HDMI 2 IN> terminal, or the <DIGITAL LINK/LAN> terminal.
- When [WIDE] is set, the image may be distorted because a signal is recognized as the same even if its synchronizing frequency varies slightly.
- When a signal to be input corresponds to multiple signals set in [WIDE], a registered signal with a high memory number receives priority. Example: a signal to be input that corresponds to memory numbers A2, A4 and B1 will be determined to be B1.

- When a registration signal is deleted, the settings are also deleted.
- In an environment where multiple types of signals are input to the same terminal, signals are sometimes not determined correctly when the setting is set to [WIDE].

### Sub memory

The projector has a sub memory function that can register the multiple image adjustment data, even if it is recognized as the same signal by the frequency or format of the synchronization signal source.

Use this function when you need to switch the aspect or adjust the picture quality such as the white balance while using the same signal source. The sub memory includes all the data that can be adjusted for each signal, such as the image aspect ratio and data adjusted in the [PICTURE] menu (items such as [CONTRAST] and [BRIGHTNESS]).

### Registering to the sub memory

- 1) **While in the normal screen (where no menu is displayed), press ▲▼.**
  - The sub memory registration screen is displayed if the sub memory is not registered. Proceed to Step 3).
  - A list of sub memories registered to the signal currently input is displayed.
  - The <FUNCTION> button on the remote control can be used instead of ▲▼ when [SUB MEMORY] is selected from the [PROJECTOR SETUP] menu → [FUNCTION BUTTON].
- 2) **Press ▲▼◀▶ to select the sub memory number to register in [SUB MEMORY LIST].**
- 3) **Press the <ENTER> button.**
  - The [SIGNAL NAME CHANGE] screen is displayed.
- 4) **Press ▲▼◀▶ to select [OK], and press the <ENTER> button.**
  - To rename the registered signal, follow the procedure in Steps 6) and 7) in “Renaming the registered signal” (➔ page 132).

### Switching to the sub memory

- 1) **While in the normal screen (where no menu is displayed), press ▲▼.**
  - A list of sub memories registered to the signal currently input is displayed.
- 2) **Press ▲▼◀▶ to select the signal to switch in [SUB MEMORY LIST].**
- 3) **Press the <ENTER> button.**
  - This switches to the signal selected in Step 2).

### Deleting the sub memory

- 1) **While in the normal screen (where no menu is displayed), press ▲▼.**
  - The [SUB MEMORY LIST] screen is displayed.
- 2) **Press ▲▼◀▶ to select the sub memory to be deleted, and press the <DEFAULT> button on the remote control.**
  - The [REGISTERED SIGNAL DELETE] screen is displayed.
  - To cancel the deletion, press the <MENU> button to return to the [SUB MEMORY LIST] screen.
- 3) **Press the <ENTER> button.**
  - The selected sub memory will be deleted.

## [SECURITY] menu

On the menu screen, select [SECURITY] from the main menu, and select an item from the sub-menu. Refer to “Navigating through the menu” (➔ page 79) for the operation of the menu screen.

- When the projector is used for the first time  
Initial password: Press ▲▶▼◀▲▶▼◀ in order, and press the <ENTER> button.

### Attention

- When you select the [SECURITY] menu and press the <ENTER> button, entering a password is prompted. Enter the preset password and then continue operations of the [SECURITY] menu.
- When the password has been changed previously, enter the changed password, and press the <ENTER> button.

### Note

- The entered password is displayed with \* marks on the screen.
- An error message is displayed on the screen when the entered password is incorrect. Re-enter the correct password.

## [SECURITY PASSWORD]

Display the [SECURITY PASSWORD] screen when the power is turned on with the <MAIN POWER> switch set to the <OFF> side. When the entered password is incorrect, the operation will be restricted to the power <⏻/|> button.

- 1) Press ▲▼ to select [SECURITY PASSWORD].
- 2) Press ◀▶ to switch the item.
  - The items will switch each time you press the button.

[OFF]	Disables the security password entry.
[ON]	Enables the security password entry.

### Note

- This item is set to [OFF] in the factory default setting or when the [PROJECTOR SETUP] menu → [INITIALIZE] → [ALL USER DATA] is executed. Set it to [ON] as necessary.
- Change the password periodically that is hard to guess.
- The security password is enabled after setting the item to [ON] and setting the <MAIN POWER> switch to <OFF>.

## [SECURITY PASSWORD CHANGE]

Change the security password.

- 1) Press ▲▼ to select [SECURITY PASSWORD CHANGE].
- 2) Press the <ENTER> button.
  - The [SECURITY PASSWORD CHANGE] screen is displayed.
- 3) Press ▲▼◀▶ and the number (<0> - <9>) buttons to set the password.
  - Up to eight button operations can be set.
- 4) Press the <ENTER> button.
- 5) Re-enter the password for the confirmation.
- 6) Press the <ENTER> button.

### Note

- The entered password is displayed with \* marks on the screen.
- When numerical values are used for the security password, the security password is required to be initialized if the remote control is lost. Consult your dealer for the method of initialization.

## [DISPLAY SETTING]

Overlap the security message (text or image) over the projecting image.

- 1) Press ▲▼ to select [DISPLAY SETTING].

2) Press ◀▶ to switch the item.

- The items will switch each time you press the button.

[OFF]	Hides the security message.
[TEXT]	Displays the text set in the [SECURITY] menu → [TEXT CHANGE].
[USER LOGO]	Displays the image registered by the user.

**Note**

- To create and register the [USER LOGO] image, use “Logo Transfer Software”. The software can be downloaded from the Panasonic website (<https://panasonic.net/cns/projector/>).

**[TEXT CHANGE]**

Edit the text to be displayed when [TEXT] is selected in [DISPLAY SETTING].

1) Press ▲▼ to select [TEXT CHANGE].

2) Press the <ENTER> button.

- The [TEXT CHANGE] screen is displayed.

3) Press ▲▼◀▶ to select the text, and press the <ENTER> button to enter the text.

4) Press ▲▼◀▶ to select [OK], and press the <ENTER> button.

- The text is changed.

**[MENU LOCK]**

Press the <MENU> button to display the menu, and set if menu operation is enabled or not.

1) Press ▲▼ to select [MENU LOCK].

2) Press ◀▶ to switch the item.

- The items will switch each time you press the button.

[OFF]	Enables the menu operation.
[ON]	Disables the menu operation.

**Note**

- This function is set to [OFF] as the factory default setting or after the [PROJECTOR SETUP] menu → [INITIALIZE] is executed. Set it to [ON] as necessary.
- When [MENU LOCK] is set to [ON], the [MENU LOCK PASSWORD] screen is displayed by pressing the <MENU> button. Menu operation is enabled by entering the set menu lock password. In this case, enabling of the menu operation is maintained until the projector goes into the standby mode.

**[MENU LOCK PASSWORD]**

Change the menu lock password.

1) Press ▲▼ to select [MENU LOCK PASSWORD].

2) Press the <ENTER> button.

- The [MENU LOCK PASSWORD] screen is displayed.

3) Press ▲▼◀▶ to select the character, and press the <ENTER> button to enter the character.

- Up to 16 characters can be entered.

4) Press ▲▼◀▶ to select [OK], and press the <ENTER> button.

- To cancel, select [CANCEL].

**Attention**

- The initial password is AAAA as the factory default or after the [PROJECTOR SETUP] menu → [INITIALIZE] is executed.
- Change the password periodically and make it hard to guess.



## [CONTROL DEVICE SETUP]

Enable/disable the button operations on the control panel and the remote control.

- 1) Press ▲▼ to select [CONTROL DEVICE SETUP].
- 2) Press the <ENTER> button.
  - The [CONTROL DEVICE SETUP] screen is displayed.
- 3) Press ▲▼ to select [CONTROL PANEL] or [REMOTE CONTROL].

[CONTROL PANEL]	Sets the limitation on the control from the control panel.
[REMOTE CONTROL]	Sets the limitation on the control from the remote control.

- 4) Press the <ENTER> button.
  - The [CONTROL PANEL] screen or the [REMOTE CONTROL] screen is displayed.
- 5) Press ▲▼ to select [CONTROL PANEL] or [REMOTE CONTROL].
- 6) Press ◀▶ to switch the item.
  - You can set the operation restriction from the control panel or the remote control.

[ENABLE]	Enables all button operations.
[DISABLE]	Disables all button operations.
[USER]	Operation of all buttons can be enabled/disabled separately. Refer to “Enabling/disabling any button” (▶ page 137) for details.

- 7) Press ▲▼ to select [APPLY], and press the <ENTER> button.
  - The confirmation screen is displayed.
- 8) Press ◀▶ to select [OK], and press the <ENTER> button.

### Enabling/disabling any button

- 1) Press ▲▼ to select [CONTROL DEVICE SETUP].
- 2) Press the <ENTER> button.
  - The [CONTROL DEVICE SETUP] screen is displayed.
- 3) Press ▲▼ to select [CONTROL PANEL] or [REMOTE CONTROL].
- 4) Press the <ENTER> button.
  - The [CONTROL PANEL] screen or the [REMOTE CONTROL] screen is displayed.
- 5) Press ▲▼ to select [CONTROL PANEL] or [REMOTE CONTROL].
- 6) Press ◀▶ to switch [USER].
- 7) Press ▲▼ to select the button item to set.
  - When [INPUT SELECT BUTTON] is selected in [REMOTE CONTROL], press the <ENTER> button, and then press ▲▼ to select the button to set.

	Buttons that can be set	
	[CONTROL PANEL]	[REMOTE CONTROL]
[POWER BUTTON]	Power <⏻/ >button	
[INPUT SELECT BUTTON]	<INPUT SELECT> button	<RGB1/2> button, <VIDEO> button, <HDMI 1> button, <HDMI 2> button, <DIGITAL LINK> button, <NETWORK/USB> button
[MENU BUTTON]	<MENU> button	
[LENS BUTTON]	<LENS> button	Lens buttons (<FOCUS>, <ZOOM>, <SHIFT>)
[AUTO SETUP BUTTON]	—	<AUTO SETUP/CANCEL> button
[SHUTTER BUTTON]	<SHUTTER> button	
[ON SCREEN BUTTON]	—	<ON SCREEN> button
[OTHER BUTTON]	▲▼◀▶, <ENTER> button	Buttons not listed above

8) Press ◀▶ to switch the item.

[ENABLE]	Enables button operations.
[DISABLE]	Disables button operations.

- The following items can be selected only when [RGB1/2 BUTTON] is selected in [INPUT SELECT BUTTON].

[TOGGLE]	Switches between [RGB1] and [RGB2] when the button is operated.
[RGB1]	Fixes to [RGB1].
[RGB2]	Fixes to [RGB2].
[DISABLE]	Disables button operations.

- The following items can be selected only when [NETWORK/USB BUTTON] is selected in [INPUT SELECT BUTTON].

[TOGGLE]	Switches the items in following order when the button is operated. [MEMORY VIEWER] → [Panasonic APPLICATION] → [MIRRORING]
[MEMORY VIEWER]	Fixes to [MEMORY VIEWER].
[Panasonic APPLICATION]	Fixes to [Panasonic APPLICATION].
[MIRRORING]	Fixes to [MIRRORING].
[DISABLE]	Disables button operations.

- When [INPUT SELECT BUTTON] is selected in Step 7), pressing the <MENU> button returns to the [CONTROL PANEL] screen or the [REMOTE CONTROL] screen once the item is switched.

9) Press ▲▼ to select [APPLY], and press the <ENTER> button.

- The confirmation screen is displayed.

10) Press ◀▶ to select [OK], and press the <ENTER> button.

**Note**

- When a button operation is performed on the the control panel or remote control where [DISABLE] is set, the [CONTROL DEVICE PASSWORD] screen is displayed.  
Enter the control device password.
- The [CONTROL DEVICE PASSWORD] screen will disappear when there is no operation for approx. 10 seconds.
- When the setting has completed, the menu screen will disappear. To operate continuously, press the <MENU> button to display the main menu.
- Even when you set button operations on the remote control disabled, operations of the <ID SET> and <ID ALL> buttons on the remote control are kept enabled.

**[CONTROL DEVICE PASSWORD CHANGE]**

The control device password can be changed.

1) Press ▲▼ to select [CONTROL DEVICE PASSWORD CHANGE].

2) Press the <ENTER> button.

- The [CONTROL DEVICE PASSWORD CHANGE] screen is displayed.

3) Press ▲▼◀▶ to select the text, and press the <ENTER> button to enter the text.

4) Press ▲▼◀▶ to select [OK], and press the <ENTER> button.

- To cancel, select [CANCEL].

**Attention**

- The initial password is "AAAA" as the factory default or when the [PROJECTOR SETUP] menu → [INITIALIZE] → [ALL USER DATA] is executed.
- Change the password periodically that is hard to guess.

## [NETWORK/USB] menu

On the menu screen, select [NETWORK/USB] from the main menu, and select an item from the sub-menu. Refer to “Navigating through the menu” (➔ page 79) for the operation of the menu screen.

- To use the wireless LAN function with the projector, it is necessary to attach the optional Wireless Module (Model No.: ET-WM300).

For details on how to attach the optional Wireless Module (Model No.: ET-WM300), refer to “Attaching the Wireless Module” (➔ page 50).

### [DIGITAL LINK MODE]

Switch the communication method of the <DIGITAL LINK/LAN> terminal of the projector.

- 1) Press ▲▼ to select [DIGITAL LINK MODE].
- 2) Press ◀▶ to switch the item.
  - The items will switch each time you press the button.

[AUTO]	Switches the communication method automatically to DIGITAL LINK, long reach, or Ethernet.
[DIGITAL LINK]	Fixes the communication method to DIGITAL LINK.
[LONG REACH]	Fixes the communication method to long reach.
[ETHERNET]	Fixes the communication method to Ethernet.

### Possible communication modes

✓: Communication possible

—: Communication not possible

Setting		Communication possible			
		Video transfer (100 m (328'1"))	Video transfer (150 m (492'2"))	Ethernet	RS-232C
[AUTO]	For DIGITAL LINK	✓	—	✓	✓
	For long reach	—	✓	✓	✓
	For Ethernet	—	—	✓*1	—
[DIGITAL LINK]		✓	—	✓	✓
[LONG REACH]		—	✓	✓	✓
[ETHERNET]		—	—	✓*1	—

\*1 Communication via a twisted-pair-cable transmitter is not available. Connect the projector to the network directly.

### Note

- The maximum transmission distance when connected with the long-reach communication method is 150 m (492'2"). In this case, the signal that the projector can receive is only up to 1080/60p (1 920 x 1 080 dots, dot clock frequency 148.5 MHz).
- When the communication method of the twisted-pair-cable transmitter is set to long reach, the projector will connect with long-reach communication method when [DIGITAL LINK MODE] is set to [AUTO]. To connect with the optional DIGITAL LINK Switcher (Model No.: ET-YFB200G) with the long-reach communication method, set [DIGITAL LINK MODE] to [LONG REACH].
- Connection will not be made correctly if the twisted-pair-cable transmitter is not supporting the long-reach communication method even if [DIGITAL LINK MODE] is set to [LONG REACH].

### [DIGITAL LINK STATUS]

Display the DIGITAL LINK connection environment.

- 1) Press ▲▼ to select [DIGITAL LINK STATUS].
- 2) Press the <ENTER> button.
  - The [DIGITAL LINK STATUS] screen is displayed.

[LINK STATUS]	One of [NO LINK], [DIGITAL LINK], [LONG REACH], or [ETHERNET] is displayed.
[HDCP STATUS]	One of [NO SIGNAL], [OFF], or [ON] is displayed.

<b>[SIGNAL QUALITY]</b>	<p>[SIGNAL QUALITY] is a numerical value of the amount of error, and the display color changes to green, yellow, or red depending on that value. Check the signal quality level while receiving a signal from the twisted-pair-cable transmitter.</p> <ul style="list-style-type: none"> <li>• [MAX]/[MIN]: Maximum/minimum value of the amount of error</li> <li>• Green (–12 dB or lower) → normal signal quality level.</li> <li>• Yellow (–11 to –8 dB) → caution level that noise may appear on the screen.</li> <li>• Red (–7 dB or more) → abnormal level that synchronization is disrupted or not possible to receive.</li> </ul>
-------------------------	---

## [DIGITAL LINK MENU]

When the optional DIGITAL LINK output supported device (Model No.: ET-YFB100G, ET-YFB200G) is connected to the <DIGITAL LINK/LAN> terminal, the main menu of the connected DIGITAL LINK output supported device is displayed. Refer to the Operating Instructions of the DIGITAL LINK output supported device for details.

### Note

- When the [NETWORK/USB] menu → [NETWORK CONTROL] → [EXTRON XTP] is set to [ON], [DIGITAL LINK MENU] cannot be selected.

## [WIRED LAN]

Perform the connection setting to use the wired LAN.

- 1) Press ▲▼ to select [WIRED LAN].
- 2) Press the <ENTER> button.
  - The [WIRED DETAILED SETUP] screen is displayed.
- 3) Press ▲▼◀▶ to select an item, and change the setting according to the operation instruction of the menu.

<b>[DHCP]</b>	<b>[ON]</b>	Select this item when there is a DHCP server in the network the projector is to be connected, and to acquire the IP address automatically.
	<b>[OFF]</b>	Select this item when there is no DHCP server in the network the projector is to be connected, and to specify the IP address.
<b>[IP ADDRESS]</b>	Enter the IP address when [DHCP] is set to [OFF].	
<b>[SUBNET MASK]</b>	Enter the subnet mask when [DHCP] is set to [OFF].	
<b>[DEFAULT GATEWAY]</b>	Enter the default gateway address when [DHCP] is set to [OFF].	
<b>[DNS1]</b>	Enter the address of the preferred DNS server when [DHCP] is set to [OFF].	
<b>[DNS2]</b>	Enter the address of the alternate DNS server when [DHCP] is set to [OFF].	
<b>[EAP]</b>	Select the EAP set for the RADIUS server. If the EAP is not set, set to [NONE]. The types of EAP that can be selected are as follows. [PEAP(MS-CHAPv2)], [PEAP(GTC)], [EAP-TTLS(MD5)], [EAP-TTLS(MS-CHAPv2)], [EAP-FAST(MS-CHAPv2)], [EAP-FAST(GTC)], [EAP-TLS]	
<b>[USER NAME]</b>	Enter the user name to be used for authentication in single-byte alphanumeric characters (excluding the space). (Maximum of 64 characters) This can be set when [EAP] is set to anything other than [NONE].	
<b>[PASSWORD]</b>	Enter the password to be used for authentication in single-byte alphanumeric characters. (Maximum of 64 characters) This can be set when [EAP] is set to anything other than [NONE].	

- 4) Once the setting change is completed, press ▲▼ to select [STORE], and press the <ENTER> button.
  - The confirmation screen is displayed.
  - When [INVALID ENTRY. PLEASE RE-ENTER.] is displayed, change the setting to correct content.
- 5) Press ◀▶ to select [OK], and press the <ENTER> button.

### Note

- For setting content of each item, consult the network administrator.
- When using EAP, the projector is required to be set according to the RADIUS server setting. For the RADIUS server setting, confirm with the network administrator.
- Wired LAN and wireless LAN cannot be used in the same segment.
- When using the projector by setting [DHCP] to [ON], confirm that the DHCP server is operating.

### ■ Factory default setting

- Following is preset as the factory default setting.

[DHCP]	[OFF]
[IP ADDRESS]	192.168.10.100
[SUBNET MASK]	255.255.255.0
[DEFAULT GATEWAY]	192.168.10.1
[DNS1]/[DNS2]	(Blank)
[EAP]	[NONE]

## [WIRELESS LAN]

Set the connection method of wireless LAN and its details.

- To use the wireless LAN function with the projector, it is necessary to attach the optional Wireless Module (Model No.: ET-WM300).

For details on how to attach the optional Wireless Module (Model No.: ET-WM300), refer to “Attaching the Wireless Module” (➔ page 50).

1) Press ▲▼ to select [WIRELESS LAN].

2) Press ◀▶ to select an item.

- The items will switch each time you press the button.

[SIMPLE]	Various devices (computer, tablet, smartphone, etc.) equipped with various OS such as Windows, Mac OS, iOS, or Android can be directly connected to the projector. Also, it is possible to connect with the projector using Panasonic image transfer application software “Wireless Manager ME6.4”, “Plug and Share”, or “Wireless Projector”. For details on setting procedure, refer to “Setting [SIMPLE]” (➔ page 141).
[M-DIRECT]	This is the mode to use the projector as a simple access point, and allows the device such as computer to directly connect to the projector in the infrastructure mode even if there is no separate access point. Use the Panasonic image transfer application software “Wireless Manager ME6.4”, “Plug and Share”, or “Wireless Projector” to connect. It can connect in easier manner when using the iPad/iPhone/iPod touch and Android devices. Also, detailed network setting can be performed in accordance with the network environment in use. For details on setting procedure, refer to “Setting [M-DIRECT]” (➔ page 142).
[USER]	Detailed network settings can be configured according to the network environment in use. For details on setting procedure, refer to “Setting [USER]” (➔ page 143).
[DISABLE]	Select this item when the wireless LAN is not to be used.

### Attention

- This device is restricted to indoor use when operated in the 2.412 to 2.472 GHz band, in the 5.18 to 5.825 GHz frequency range (Channels 36 to 165).
- Using the projector outside the country  
Note that depending on countries or regions there are restrictions on the channels and frequencies at which you can use the wireless LAN.

### Note

- When [SIMPLE] or [M-DIRECT] is set, maximum number of devices that can be connected to the projector via the wireless LAN simultaneously is 10 devices.
- Even if [SIMPLE] or [M-DIRECT] is set, the setting is disabled while MIRRORING input is selected.
- For how to use the image transfer application software “Wireless Manager ME6.4” compatible to the Windows computer or Mac, refer to the Operating Instructions of “Wireless Manager ME6.4”. The software can be downloaded from the Panasonic website (<https://panasonic.net/cns/projector/>).
- For how to use the image transfer application software “Plug and Share” allowing to easily connect via the wireless LAN by pairing the commercially available USB memory with the projector, refer to following URL.  
<https://panasonic.net/cns/projector/>  
For the method of pairing the projector and the USB memory, refer to “Using the pairing function” (➔ page 193). By pairing, the connection information between the image transfer application software “Plug and Share”, and the projector and the USB memory is written into the USB memory.
- For details of the image transfer application software “Wireless Projector” compatible with the iPad/iPhone/iPod touch or Android device, refer to the following URL.  
<https://panasonic.net/cns/projector/>

### Setting [SIMPLE]

1) Press ▲▼ to select [WIRELESS LAN].

2) Press ◀▶ to select [SIMPLE].

- 3) Press the <ENTER> button.
  - The [WIRELESS DETAILED SETUP] screen is displayed.
- 4) Press ▲▼◀▶ to select [KEY].
- 5) Press the <ENTER> button.
  - The [KEY] screen is displayed.
- 6) Press ▲▼◀▶ to select the character, and press the <ENTER> button to enter the character.
  - The character string that can be registered as the key is as follows.
    - 8 to 15 alphanumeric characters
- 7) Once the entry of key is completed, press ▲▼◀▶ to select [OK], and press the <ENTER> button.
- 8) Press ▲▼ to select [STORE], and press the <ENTER> button.
  - The confirmation screen is displayed.
- 9) Press ◀▶ to select [OK], and press the <ENTER> button.

**Note**

- The factory default setting for [KEY] is set to the same character string as the network ID “Projxxxx” (xxxx is 4-digit number). The network ID is a fixed value assigned to each product. The network ID can be confirmed in the standby screen projected when switched to Panasonic APPLICATION input.

**Setting [M-DIRECT]**

- 1) Press ▲▼ to select [WIRELESS LAN].
- 2) Press ◀▶ to select [M-DIRECT].
- 3) Press the <ENTER> button.
  - The [WIRELESS DETAILED SETUP] screen is displayed.
- 4) Press ▲▼◀▶ to select an item, and change the setting according to the operation instruction of the menu.

[IP ADDRESS]	Enter the IP address.
[SUBNET MASK]	Enter the subnet mask.
[SSID]	Set SSID to be used.
[CHANNEL]	Select the channel to be used.
[KEY]	Set the key to be used. Enter 8 to 63 characters of ASCII character, or 64-digit hexadecimal number.

- 5) Once the setting change is completed, press ▲▼ to select [STORE], and press the <ENTER> button.
  - The confirmation screen is displayed.
- 6) Press ◀▶ to select [OK], and press the <ENTER> button.

**Note**

- By leaving the [KEY] setting as the factory default value, it is possible for the malicious third party to intercept the radio wave, and content of the communication may be eavesdropped. Be sure to change it from the factory default value.
- For setting content of each item, consult the network administrator.
- Do not use in ANY connection with SSID set to “any” or “ANY” character string. ANY connection is a method to connect to a wireless LAN device with best reception that was detected in the range where the radio wave reaches the wireless LAN compatible device.
- Depending on the device, key may be represented as “password for SSID”.
- The authentication method is fixed to WPA2-PSK and the encryption method is fixed to AES.
- When [M-DIRECT] is set, the projector will function as a DHCP server. Set the device to connect to the projector via LAN to automatically acquire the IP address.

**■ Factory default setting**

- Following is preset as the factory default setting.

[IP ADDRESS]	192.168.12.100
[SUBNET MASK]	255.255.255.0

[SSID]	M-DIRECTxxxx (xxxx is the last four digits of the network ID. The network ID is a fixed value assigned to each product. The network ID can be confirmed in the standby screen projected when switched to Panasonic APPLICATION input.)
[CHANNEL]	1
[KEY]	M-DIRECTxxxx (the same character string as [SSID])

### Setting [USER]

- 1) Press ▲▼ to select [WIRELESS LAN].
- 2) Press ◀▶ to select [USER].
- 3) Press the <ENTER> button.
  - The [WIRELESS LAN] screen is displayed and the search result of SSID is displayed. Maximum number of SSID that can be detected at once is 50 (maximum of 5 pages).
  - Currently selected SSID is always displayed at the top, and ● mark is displayed at the left.
  - A key icon is displayed for the encrypted SSID.
  - The antenna level of each SSID is indicated with the number of ■. More the number indicates higher the antenna level.
  - To search the SSID again, press the <DEFAULT> button.
- 4) Press ▲▼ to select the SSID to connect from the search result, and press the <ENTER> button.
  - To set the SSID without selecting from the search result, select [OTHER].
  - The [WIRELESS DETAILED SETUP] screen (1/2) is displayed.
- 5) Press ▲▼◀▶ to select an item, and change the setting according to the operation instruction of the menu.

[SSID]	Enter the same string as the SSID registered to the access point. This item can be set when the SSID with the ● mark at the top was selected in Step 4), or when [OTHER] was selected.	
[AUTHENTICATION]	Select the user authentication method used in the network to which the projector is connected.	
	[OPEN]	Select this item when the authentication method for the access point is Open System.
	[SHARED]	Select this item when the authentication method for the access point is Shared Key.
	[WPA-PSK]	Select this item when the authentication method for the access point is WPA-PSK.
	[WPA2-PSK]	Select this item when the authentication method for the access point is WPA2-PSK.
	[WPA-EAP/WPA2-EAP]	Select this item when the authentication method of the access point is WPA-EAP/WPA2-EAP.
	[WPA-EAP]	Select this item when the authentication method for the access point is WPA-EAP.
[ENCRYPTION]	Select the encryption method used for the communication between the projector and the network.	
	[NONE]	Select this item not to use encryption. This item can be selected only when [AUTHENTICATION] is set to [OPEN] or [SHARED].
	[WEP]	Select this item when the encryption method is WEP. This item can be selected when [AUTHENTICATION] is set to [OPEN] or [SHARED].
	[TKIP]	Select this item when the encryption method is TKIP. This item can be selected when [AUTHENTICATION] is set to [WPA-PSK], [WPA2-PSK], [WPA-EAP], or [WPA2-EAP].
	[AES]	Select this item when AES is used as the encryption method. This item can be selected when [AUTHENTICATION] is set to [WPA-PSK], [WPA2-PSK], [WPA-EAP], or [WPA2-EAP].
[DEFAULT KEY]	Set one of numbers from [1] to [4] as the default key. This item can be set when [AUTHENTICATION] is set to [OPEN] or [SHARED], and [ENCRYPTION] is set to [WEP].	

[KEY1] - [KEY4]	Set WEP key to the key number selected in [DEFAULT KEY]. This item can be selected only when [AUTHENTICATION] is set to [OPEN] or [SHARED], and the encryption method is [WEP]. Only the 64 bits or 128 bits WEP key can be set. For 64 bits, enter five characters in alphanumeric (10 digits in case of hexadecimal), and for 128 bits, enter 13 characters in alphanumeric (26 digits in case of hexadecimal).
[KEY]	Set the key. This item can be set when [AUTHENTICATION] is set to [WPA-PSK] or [WPA2-PSK]. Enter 8 to 63 characters of ASCII character, or 64-digit hexadecimal number.
[EAP]	Select the EAP set for the RADIUS server. This item can be set when [AUTHENTICATION] is set to [WPA-EAP/WPA2-EAP], [WPA-EAP], or [WPA2-EAP]. The types of EAP that can be selected are as follows. [PEAP(MS-CHAPv2)], [PEAP(GTC)], [EAP-TTLS(MD5)], [EAP-TTLS(MS-CHAPv2)], [EAP-FAST(MS-CHAPv2)], [EAP-FAST(GTC)], [EAP-TLS]
[USER NAME]	Enter the user name to be used for authentication in single-byte alphanumeric characters (excluding the space). (Maximum of 64 characters) This item can be set when [AUTHENTICATION] is set to [WPA-EAP/WPA2-EAP], [WPA-EAP], or [WPA2-EAP].
[PASSWORD]	Enter the password to be used for authentication in single-byte alphanumeric characters. (Maximum of 64 characters) This item can be set when [AUTHENTICATION] is set to [WPA-EAP/WPA2-EAP], [WPA-EAP], or [WPA2-EAP].

6) Press ▲▼ to move to next page.

- The [WIRELESS DETAILED SETUP] screen (2/2) is displayed.

7) Press ▲▼◀▶ to select an item, and change the setting according to the operation instruction of the menu.

[DHCP]	[OFF]	Select this item when there is no DHCP server in the network to which the projector is to be connected, and to specify the IP address.
	[ON]	Select this item when there is a DHCP server in the network to which the projector is to be connected, and to acquire the IP address automatically.
[IP ADDRESS]	Enter the IP address when [DHCP] is set to [OFF].	
[SUBNET MASK]	Enter the subnet mask when [DHCP] is set to [OFF].	
[DEFAULT GATEWAY]	Enter the default gateway address when [DHCP] is set to [OFF].	
[DNS1]	Enter the address of the preferred DNS server when [DHCP] is set to [OFF].	
[DNS2]	Enter the address of the alternate DNS server when [DHCP] is set to [OFF].	

8) Once the setting is completed, press ▲▼ to select [STORE], and press the <ENTER> button.

- The confirmation screen is displayed.
- When [INVALID ENTRY. PLEASE RE-ENTER.] is displayed, change the setting to correct content.

9) Press ◀▶ to select [OK], and press the <ENTER> button.

**Note**

- For setting content of each item, consult the network administrator.
- When using EAP, the projector is required to be set according to the RADIUS server setting. For setting the server, consult the network administrator.
- When using the EAP combined with an access point with the SSID broadcast disabled, select [WPA-EAP] or [WPA2-EAP] as the authentication method even if the authentication of the access point is WPA-EAP/WPA2-EAP.
- Wired LAN and wireless LAN cannot be used in the same segment.
- When using the projector by setting [DHCP] to [ON], confirm that the DHCP server is operating.
- If the LAN connection is not established via access point even when "Setting of the projector" (➔ page 156) is executed, consult the manufacturer of the used access point (radio wave repeater).

**■ Factory default setting**

- Following is preset as the factory default setting.

[AUTHENTICATION]	[OPEN]
[ENCRYPTION]	[NONE]
[DHCP]	[OFF]
[IP ADDRESS]	192.168.11.100



[SUBNET MASK]	255.255.255.0
[DEFAULT GATEWAY]	192.168.11.1
[DNS1]/[DNS2]	(Blank)

## [PROJECTOR NAME]

Name of the projector can be changed. Enter if a host name is required when using the DHCP server, etc.

- 1) Press ▲▼ to select [PROJECTOR NAME].
- 2) Press the <ENTER> button.
  - The [PROJECTOR NAME CHANGE] screen is displayed.
- 3) Press ▲▼◀▶ to select the character, and press the <ENTER> button to enter the character.
  - Up to 16 characters can be entered.
- 4) Once the entry of the projector name is completed, press ▲▼◀▶ to select [OK], and press the <ENTER> button.
  - To cancel, select [CANCEL].

### Note

- The factory default of the projector name is "Namexxxx". xxxx is the last four digits of the network ID. The network ID is a fixed value assigned to each product. The network ID can be confirmed in the standby screen projected when switched to Panasonic APPLICATION input.

## [NETWORK CONTROL]

Set up the control method of the network.

- 1) Press ▲▼ to select [NETWORK CONTROL].
- 2) Press the <ENTER> button.
  - The [NETWORK CONTROL] screen is displayed.
- 3) Press ▲▼ to select an item, and press ◀▶ to change the setting.

[WEB CONTROL]	Set to [ON] to control with the web browser.
[PJLink CONTROL]	Set to [ON] to control with the PJLink protocol.
[PJLink NOTIFICATION]	Set to [ON] to use the PJLink notification function. <ul style="list-style-type: none"> <li>• The [PJLink NOTIFICATION] screen is displayed when set to [ON] and the &lt;ENTER&gt; button is pressed. Set the IP address of the computer to notify the status of the projector in [NOTIFIED IP ADDRESS 1], [NOTIFIED IP ADDRESS 2].</li> </ul>
[COMMAND CONTROL]	Set to [ON] to control with the control command format (➔ page 215) for the <SERIAL IN> terminal. Refer to "Control commands via LAN" (➔ page 210).
[COMMAND PORT]	Set the port number used for command control.
[Crestron Connected(TM)]	Set to [ON] to control with Crestron Connected™ of Crestron Electronics, Inc.
[AMX D.D.]	Set to [ON] to control with the controller of AMX Corporation. Setting this function to [ON] enables detection through "AMX Device Discovery". For details, visit the website of AMX Corporation. URL <a href="http://www.amx.com/">http://www.amx.com/</a>
[EXTRON XTP]	Set to [ON] when connecting the "XTP transmitter" of Extron Electronics to the <DIGITAL LINK/LAN> terminal. The [EXTRON XTP] setting must be set to [OFF] when connecting the optional DIGITAL LINK output supported device (Model No.: ET-YFB100G, ET-YFB200G). For details of the "XTP transmitter", visit the website of Extron Electronics. URL <a href="http://www.extron.com/">http://www.extron.com/</a>

- 4) Press ▲▼ to select [STORE], and press the <ENTER> button.
  - The confirmation screen is displayed.
- 5) Press ◀▶ to select [OK], and press the <ENTER> button.

## [MEMORY VIEWER]

Set the operation of the Memory Viewer.

- 1) Press ▲▼ to select [MEMORY VIEWER].

- 2) Press the <ENTER> button.
  - The [MEMORY VIEWER] screen is displayed.
- 3) Press ▲▼ to select an item, and press ◀▶ to change the setting.
  - The items will switch each time you press the button.

[VIEW]	Sets the display view of the Memory Viewer screen.	
	[THUMBNAIL]	Displays the files in thumbnail view.
	[LIST]	Displays the files in list view.
[SORT]	Sets the display order of files in the Memory Viewer screen.	
	[NAME]	Displays the files in the ascending order by the file name.
	[TYPE]	Displays the files by the types of files.
[AUTOPLAY]	Enables/disables automatic playback.	
	[OFF]	Select this item to disable automatic playback.
	[ON]	Select this item to enable automatic playback.
[SCENARIO]	Select this item to perform automatic playback following the scenario file registered from "Multi Monitoring & Control Software".	
	[INTERVAL]	Sets display duration of the still image that is being automatically played back.
	[5S] - [120S]	Sets the display duration of still image. Select an item from [5S], [10S], [15S], [30S], [60S], and [120S].
[EFFECT]	Sets special effects used when changing the playback screen of still image content.	
	[OFF]	Does not apply special effects.
	[RANDOM]	Applies special effects randomly.
	[WIPE LEFT]	Displays the image gradually from the left like wiping.
	[WIPE RIGHT]	Displays the image gradually from the right like wiping.
	[WIPE DOWN]	Displays the image gradually from the top like wiping.
	[SPLIT]	Displays the image gradually from the center toward the left and right like wiping.
	[ZOOM OUT]	Displays the image gradually from the center towards the entire image.
	[FADE]	Displays the entire image gradually.
	[BLIND]	Displays the image gradually like opening vertical blind.
	[CHECKER WIPE]	Displays the image gradually from the left to right in checkerboard patterns.
	[SLIDE IN]	Displays the next screen as if it slides in from the right to left.
[SLIDE OUT]	Displays the next screen by removing the current screen as if it slides out from the right to left.	
[GUIDE]	Shows/hides the operation guide on the playback screen and the time bar that visually represents the playback progress of a movie.	
	[ON]	Select this item to display the operation guide and the time bar (only for movie playback) while playing back the still image/movie.
	[OFF]	Select this item not to display the operation guide and the time bar while playing back the still image/movie.

### Note

- For how to use the Memory Viewer, refer to "Projecting with MEMORY VIEWER input" (➔ page 185).
- When [AUTOPLAY] is set to [OFF] or [SCENARIO], [INTERVAL] cannot be set.
- Even if the setting for [INTERVAL] or [EFFECT] is changed while a still image or movie is being played back in the Memory Viewer, it is not reflected to the projected image being played back. Return to the Memory Viewer screen in the thumbnail view or list view and restart playback.
- Even if [GUIDE] is set to [ON], the operation guide and the time bar will automatically be erased approximately three seconds after playback is started.
- Even if [GUIDE] is set to [OFF], the operation guide and the time bar is displayed during the fast-forward or rewind.
- Even if the operation guide is not displayed, operation of the Memory Viewer by ▲▼◀▶, the <ENTER> button, or the <AUTO SETUP/CANCEL> button during the playback is enabled.
- The contents list that can be selected in [SCENARIO] of [AUTOPLAY] uses the "Delivering contents list" function of the "Multi Monitoring & Control Software".
- When [AUTOPLAY] is set to [SCENARIO], the playback order and the playback time follow the scenario file registered using the "Multi Monitoring & Control Software".
- When [AUTOPLAY] is set to [SCENARIO], the Light ID set with the "Multi Monitoring & Control Software" is transmitted.

**[Panasonic APPLICATION]**

Set the operation when a device such as computer is to be connected via LAN using the Panasonic application software.

**Setting [MODERATOR MODE]**

Set if [MODERATOR MODE] is enabled or not, which allows the moderator can specify the presenter when multiple devices are connected to the projector using the Panasonic image transfer application software.

- 1) Press ▲▼ to select [Panasonic APPLICATION].
- 2) Press the <ENTER> button.
  - The [Panasonic APPLICATION] screen is displayed.
- 3) Press ▲▼ to select [MODERATOR MODE].
- 4) Press ◀▶ to select an item.
  - The items will switch each time you press the button.

[OFF]	Disables [MODERATOR MODE]. Select this item when the user of each device is to operate to display full screen or not.
[ON]	Enables [MODERATOR MODE]. Select this item when the moderator is to operate the projector and specifies the image to display in full screen from the images of multiple devices displayed in thumbnail.

**Note**

- When [ON] is set, cut-in of image by other user is not possible.
- For how to operate the moderator mode in the Panasonic APPLICATION input, refer to “Projecting with Panasonic APPLICATION input” (➔ page 178).
- The image transfer application software used for Panasonic APPLICATION input are as follows.
  - Wireless Manager ME6.4
  - Plug and Share
  - Wireless Projector for iOS, Wireless Projector for Android
- For how to use the image transfer application software “Plug and Share” allowing to easily connect via the wireless LAN by pairing the commercially available USB memory with the projector, refer to following URL.  
<https://panasonic.net/cns/projector/>  
For the method of pairing the projector and the USB memory, refer to “Using the pairing function” (➔ page 193). By pairing, the connection information between the image transfer application software “Plug and Share”, and the projector and the USB memory is written into the USB memory.
- For details regarding “Wireless Projector”, refer to the following URL.  
<https://panasonic.net/cns/projector/>

**Setting [CUT IN]**

Set if the cut-in of image by other user or cut-in of image by the simultaneous image distribution function of “Multi Monitoring & Control Software” is allowed or not while projecting an image of the device screen using the Panasonic image transfer application software.

- 1) Press ▲▼ to select [Panasonic APPLICATION].
- 2) Press the <ENTER> button.
  - The [Panasonic APPLICATION] screen is displayed.
- 3) Press ▲▼ to select [CUT IN].
- 4) Press ◀▶ to select an item.
  - The items will switch each time you press the button.

[ON]	Select this item when allowing the cut-in of an image.
[OFF]	Select this item when prohibiting the cut-in of an image.

**Note**

- When [MODERATOR MODE] is set to [ON], [CUT IN] cannot be set.
- When both “Multi Monitoring & Control Software” and “Wireless Manager ME6.4” are running on a single computer, the simultaneous image distribution function of “Multi Monitoring & Control Software” may not operate properly. If it is necessary to run these two applications simultaneously, prepare a computer for each of the application.

### Setting [PASSWORD]

It is possible to ask the input of password against the device when trying to connect to the projector using the Panasonic image transfer application software. By requiring the input of password, it is possible to prevent image cut-in caused by erroneous external connection.

- 1) Press ▲▼ to select [Panasonic APPLICATION].
- 2) Press the <ENTER> button.
  - The [Panasonic APPLICATION] screen is displayed.
- 3) Press ▲▼ to select [PASSWORD].
- 4) Press ◀▶ to select an item.
  - The items will switch each time you press the button.

[OFF]	Select this item when not requiring input of password at the time of connection.
[ON]	Select this item when requiring input of password at the time of connection.

### Note

- This function is set to [OFF] as the factory default setting or after the [NETWORK/USB] menu → [INITIALIZE] is executed. When connecting to the projector using the image transfer application software, it is recommended to register a password in the [NETWORK/USB] menu → [Panasonic APPLICATION] → [PASSWORD CHANGE], and set [PASSWORD] to [ON].
- When [ON] is set, receiving of distributed image by the simultaneous image distribution function or erasing of image by the distributed image erasing function of the “Multi Monitoring & Control Software” is not possible. To use these functions, set [OFF].

### Setting [PASSWORD CHANGE]

Register or change the password to enter when connecting to the projector using the Panasonic image transfer application software.

- 1) Press ▲▼ to select [Panasonic APPLICATION].
- 2) Press the <ENTER> button.
  - The [Panasonic APPLICATION] screen is displayed.
- 3) Press ▲▼ to select [PASSWORD CHANGE].
- 4) Press the <ENTER> button.
  - The [PASSWORD CHANGE] screen is displayed.
- 5) Press ▲▼◀▶ to select the character, and press the <ENTER> button to enter the character.
  - Maximum of 8 ASCII characters can be entered.
- 6) Press ▲▼◀▶ to select [OK], and press the <ENTER> button.
  - Entered password is registered.
  - To cancel, select [CANCEL].

### Note

- As the factory default or after the [NETWORK/USB] menu → [INITIALIZE] is executed, the password is blank. Even if [PASSWORD] is set to [ON], it will be possible to connect without entering the character if the password is not registered. Make sure to register a password when setting [PASSWORD] to [ON].
- Change the password periodically and make it hard to guess.

### Setting [PAIRING GUIDE]

Set if the pairing function to display the guide for writing the pairing data on the standby screen when USB memory is connected to the <VIEWER/PAIRING> terminal while the Panasonic APPLICATION input is selected is enabled or not. The pairing data is a connection information between the image transfer application software “Plug and Share”, and the projector and the USB memory.

- 1) Press ▲▼ to select [Panasonic APPLICATION].
- 2) Press the <ENTER> button.
  - The [Panasonic APPLICATION] screen is displayed.
- 3) Press ▲▼ to select [PAIRING GUIDE].

4) Press ◀▶ to select an item.

- The items will switch each time you press the button.

[ON]	Enables the pairing function. Detects the USB memory connected to the <VIEWER/PAIRING> terminal, and displays the guide to execute the pairing in the standby screen.
[OFF]	Disables the pairing function. Does not detect even if USB memory is connected to the <VIEWER/PAIRING> terminal.

**Note**

- The [PAIRING GUIDE] setting is enabled when the Panasonic APPLICATION input is selected.
- For the method of pairing the projector and the USB memory, refer to “Using the pairing function” (➔ page 193).
- For the handling of the USB memory, refer to “Using the USB memory” (➔ page 69).
- For how to use the image transfer application software “Plug and Share” allowing to easily connect via the wireless LAN by pairing the commercially available USB memory with the projector, refer to following URL.  
<https://panasonic.net/cns/projector/>  
For the method of pairing the projector and the USB memory, refer to “Using the pairing function” (➔ page 193). By pairing, the connection information between the image transfer application software “Plug and Share”, and the projector and the USB memory is written into the USB memory.

**[MIRRORING]**

Set the operation when connecting a device to the projector using the mirroring function.

- To use the mirroring function, it is necessary to attach the optional Wireless Module (Model No.: ET-WM300).  
For details on how to attach the optional Wireless Module (Model No.: ET-WM300), refer to “Attaching the Wireless Module” (➔ page 50).

**Setting the connection**

Set the connection by the mirroring function.

- 1) Press ▲▼ to select [MIRRORING].
- 2) Press the <ENTER> button.
  - The [MIRRORING] screen is displayed.
- 3) Press ▲▼ to select an item, and press ◀▶ to change the setting.

[CONNECTION TYPE]	[AUTO]	Select the connection method when performing the connection with the mirroring function to the projector for the first time.	Select this item when connecting automatically.
	[PIN]		Select this item to display a PIN (eight-digit number) in the MIRRORING input standby screen, and connect by entering that PIN in the device side.
[CHANNEL]		Select the channel to be used.	
[MOBILE CONNECTION]	[OFF]	Select this item when the connectivity is bad. Set [OFF] normally.	Disables the function.
	[ON]		Enables the function.

**Note**

- When [CONNECTION TYPE] is set to [AUTO] and the projector cannot be connected depending on the device in use, use the projector by setting to [PIN].
- When connecting with a device that has previously connected to the projector with the mirroring function, it will connect automatically regardless of the [CONNECTION TYPE] setting.

**Setting [MODERATOR MODE]**

Set if [MODERATOR MODE], which allows the moderator to specify the presenter when multiple devices are in the condition to connect with the projector with mirroring, is enabled or not.

- 1) Press ▲▼ to select [MIRRORING].
- 2) Press the <ENTER> button.
  - The [MIRRORING] screen is displayed.
- 3) Press ▲▼ to select [MODERATOR MODE].

4) Press ◀▶ to select an item.

- The items will switch each time you press the button.

[OFF]	Disables the moderator mode. Number of device that can connect to the projector and display the image is restricted to one.
[ON]	Enables the moderator mode. Select this item when the moderator is to operate the projector and specify the device to display the screen image from the multiple devices displayed in the standby screen.

**Note**

- When [ON] is set, cut-in of connection by other user is not possible.
- For how to operate the moderator mode in the MIRRORING input, refer to “Projecting with MIRRORING input” (▶ page 181).

**Setting [CUT IN]**

Sets if the cut-in of connection by other user when the projector is displaying the screen of the device for specific user is allowed or not.

1) Press ▲▼ to select [MIRRORING].

2) Press the <ENTER> button.

- The [MIRRORING] screen is displayed.

3) Press ▲▼ to select [CUT IN].

4) Press ◀▶ to select an item.

- The items will switch each time you press the button.

[ON]	Select this item when allowing the cut-in. Clears the connection with the current device, switches the connection to the device with new connection request, and displays that image.
[OFF]	Select this item when prohibiting the cut-in. Maintains the connection with the current device.

**Note**

- When [MODERATOR MODE] is set to [ON], [CUT IN] cannot be set.

**[NETWORK STATUS]**

Display the status of the projector network.

1) Press ▲▼ to select [NETWORK STATUS].

2) Press the <ENTER> button.

- The [NETWORK STATUS] screen is displayed.

3) Press ◀▶ to switch the display screen.

- The page will change each time you press the button.  
[WIRED LAN] (page 1/3), [WIRELESS LAN] (page 2/3), [WIRELESS LAN] (page 3/3)

[WIRED LAN]	Displays the network information of the wired LAN set on the projector.	
	[DHCP]	Displays the status of use of DHCP server.
	[IP ADDRESS]	Displays the [IP ADDRESS].
	[SUBNET MASK]	Displays the [SUBNET MASK].
	[DEFAULT GATEWAY]	Displays the [DEFAULT GATEWAY].
	[DNS1]	Displays the address of the preferred DNS server.
	[DNS2]	Displays the address of the alternate DNS server.
	[MAC ADDRESS]	Displays the [MAC ADDRESS] of wired LAN.
[EAP]	Displays the type of EAP.	

<b>[WIRELESS LAN]</b>		Displays the network information of the wireless LAN set on the projector.
	<b>[ANTENNA LEVEL]</b>	Displays the signal status of wireless LAN.
	<b>[NETWORK]</b>	Displays the connection method of wireless LAN.
	<b>[SSID]</b>	Displays the string of SSID.
	<b>[AUTHENTICATION]</b>	Displays the user authentication method.
	<b>[EAP]</b>	Displays the type of EAP.
	<b>[ENCRYPTION]</b>	Displays the encryption method.
	<b>[DEFAULT KEY]</b>	Displays the [DEFAULT KEY] setting.
	<b>[DHCP]</b>	Displays the status of use of DHCP server.
	<b>[IP ADDRESS]</b>	Displays the [IP ADDRESS].
	<b>[SUBNET MASK]</b>	Displays the [SUBNET MASK].
	<b>[DEFAULT GATEWAY]</b>	Displays the [DEFAULT GATEWAY].
	<b>[DNS1]</b>	Displays the address of the preferred DNS server.
	<b>[DNS2]</b>	Displays the address of the alternate DNS server.
<b>[MAC ADDRESS]</b>	Displays the [MAC ADDRESS] of wireless LAN.	

**Note**

- When [WIRELESS LAN] is set to [DISABLE], the [WIRELESS LAN] page in the [NETWORK STATUS] screen is not displayed.

# Chapter 5 Operations

---

This chapter describes how to use each function.



# Network connection

The projector is equipped with the network function, and following is possible by connecting to a computer.

- **Web control**

Setting, adjustment, and displaying status of the projector are possible by accessing the projector from a computer.

Refer to “Web control function” (➔ page 158) for details.

- **Multi Monitoring & Control Software**

“Multi Monitoring & Control Software”, a software application to monitor and control multiple display devices (projector or flat panel display) connected to intranet, can be used.

Plug-in software “Early Warning Software”, which monitors the status of the display devices and their peripherals within an intranet, and notifies of abnormality of such equipment and detects the signs of possible abnormality, can also be used.

For details, visit the Panasonic website (<https://panasonic.net/cns/projector/>).

- **Image transfer application software**

Using the Panasonic image transfer application software, the image sent from a device can be displayed as a projected image.

For details, refer to “Projecting with Panasonic APPLICATION input” (➔ page 178).

For how to use the image transfer application software “Wireless Manager ME6.4” compatible to the Windows computer or Mac, refer to the Operating Instructions of “Wireless Manager ME6.4”.

For how to use the image transfer application software “Plug and Share” allowing to easily connect via the wireless LAN by pairing the commercially available USB memory with the projector, refer to the Operating Instruction of “Plug and Share”. For the method of pairing the projector and the USB memory, refer to “Using the pairing function” (➔ page 193). By pairing, the connection information between the image transfer application software “Plug and Share”, and the projector and the USB memory is written into the USB memory.

The application software and Operating Instructions for “Wireless Manager ME6.4” and “Plug and Share” can be used by downloading from the Panasonic website (<https://panasonic.net/cns/projector/>).

For details of the image transfer application software “Wireless Projector” compatible with the iPad/iPhone/iPod touch or Android device, refer to the Panasonic website (<https://panasonic.net/cns/projector/>).

- **Mirroring**

By using the mirroring function, the screen of the device connected via wireless LAN can be displayed as a projected image.

For details, refer to “Projecting with MIRRORING input” (➔ page 181).

- **PJLink**

Operation or status query of the projector can be performed from a computer using the PJLink protocol.

Refer to “PJLink protocol” (➔ page 209) for details.

- **Command control**

Operation or status query of the projector can be performed from a computer using the control command.

Refer to “Control commands via LAN” (➔ page 210) for details.

## Connecting via wired LAN

This projector can receive the Ethernet signal from the twisted-pair-cable transmitter together with the video, audio, and serial control signal via a LAN cable.

### Example of a normal network connection

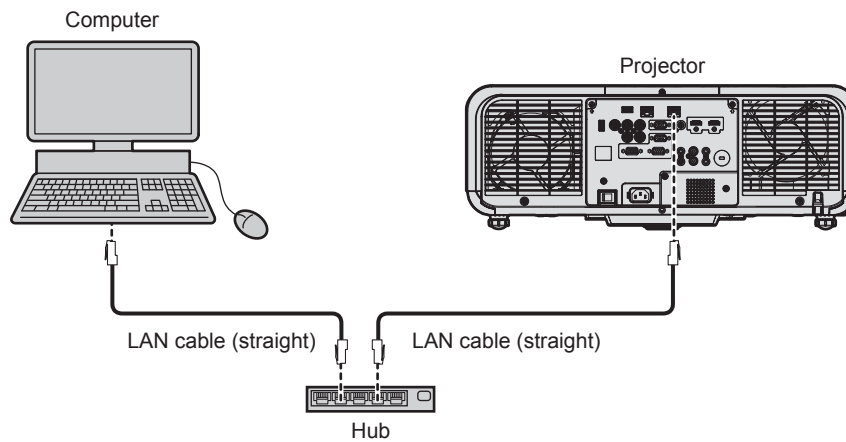

#### Attention

- When a LAN cable is directly connected to the projector, the network connection must be made indoors.

#### Note

- A LAN cable is required to use the network function via wired LAN.
- Connect a LAN cable to send and receive the Ethernet signal to the <LAN> terminal or the <DIGITAL LINK/LAN> terminal of the projector.
- Use a straight or crossover LAN cable that is compatible with CAT5 or higher. Either the straight or the crossover cable, or both cables can be used depending on the system configuration. Consult your network administrator. The projector will determine the type of the cable (straight or crossover) automatically.
- Use a LAN cable of 100 m (328'1") or shorter.

### Example of network connections via a twisted-pair-cable transmitter

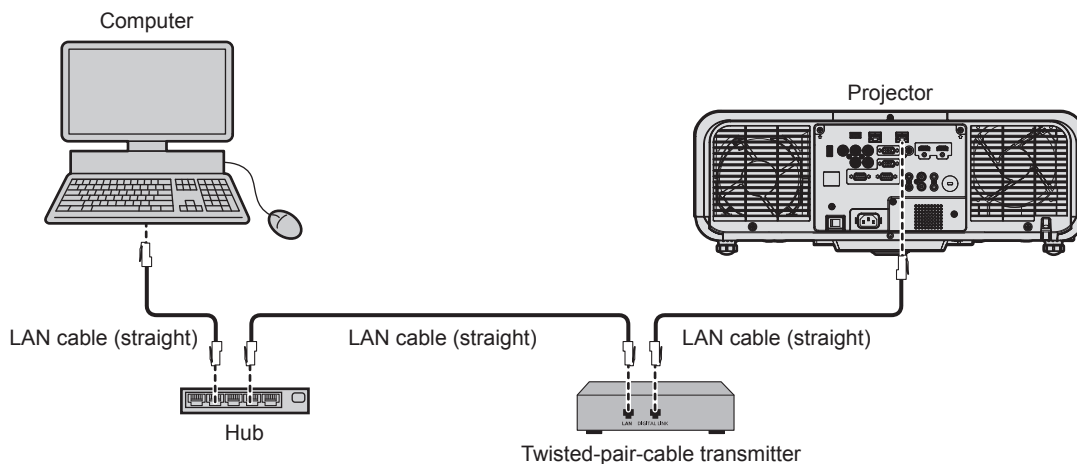

#### Attention

- When a LAN cable is directly connected to the projector, the network connection must be made indoors.

#### Note

- For the LAN cable between the twisted-pair-cable transmitter and the projector, use a cable that meets the following criteria:
  - Conforming to CAT5e or higher standards
  - Shielded type (including connectors)
  - Straight-through
  - Single wire
- The maximum transmission distance between the twisted-pair-cable transmitter and the projector is 100 m (328'1"). It is possible to transmit up to 150 m (492'2") if the twisted-pair-cable transmitter supports the long-reach communication method. However, the signal that the projector can receive is only up to 1080/60p (1 920 x 1 080 dots, dot clock frequency 148.5 MHz) for the long-reach communication method. If this distance is exceeded, image may be disrupted or a malfunction may occur in LAN communication.

- When laying cables between the twisted-pair-cable transmitter and the projector, confirm that cable characteristics are compatible with CAT5e or higher using tools such as a cable tester or cable analyzer.  
When a relay connector is used, include it in the measurement.
- Do not use a hub between the twisted-pair-cable transmitter and the projector.
- Do not pull cables forcefully. Also, do not bend or fold cables unnecessarily.
- To reduce the effects of noise as much as possible, stretch out the cables between the twisted-pair-cable transmitter and the projector without any loops.
- Lay the cables between the twisted-pair-cable transmitter and the projector away from other cables, particularly power cables.
- When laying multiple cables, run them side by side along the shortest distance possible without bundling them together.
- After laying the cable, confirm that the value of [SIGNAL QUALITY] in the [NETWORK/USB] menu → [DIGITAL LINK STATUS] is displayed in green, which indicates a normal quality.
- For twisted-pair-cable transmitters of other manufacturers that the operation has been verified with this projector, visit the Panasonic website (<https://panasonic.net/cns/projector/>). Note that the verification for devices of other manufacturers has been made for the items set by Panasonic Corporation, and not all the operations have been verified. For operation or performance problems caused by the devices of other manufacturers, contact the respective manufacturers.

## Setting the projector

- 1) Connect the projector to a computer using a LAN cable.
- 2) Turn on the power of the projector.
- 3) From the main menu, select the [NETWORK/USB] menu → [WIRED LAN], and press the <ENTER> button.
- 4) Perform the [WIRED LAN] setting.
  - For details, refer to [WIRED LAN] (➔ page 140).

### Note

- To connect to an existing network, perform after consulting your network administrator.

### ■ Factory default setting

- Following is preset as the factory default setting.

[DHCP]	[OFF]
[IP ADDRESS]	192.168.10.100
[SUBNET MASK]	255.255.255.0
[DEFAULT GATEWAY]	192.168.10.1
[DNS1]/[DNS2]	(Blank)
[EAP]	[NONE]

## Operating the computer

- 1) Turn on the power of the computer.
- 2) Perform the network setting following the instruction of your network administrator.
  - Operation from the computer is possible by configuring the network setting of the computer as follows if the projector is in the factory default setting.

[IP ADDRESS]	192.168.10.101
[SUBNET MASK]	255.255.255.0
[DEFAULT GATEWAY]	192.168.10.1

## Connecting with the wireless LAN

To use the wireless LAN function with the projector, it is necessary to attach the optional Wireless Module (Model No.: ET-WM300).

For details on how to attach the optional Wireless Module (Model No.: ET-WM300), refer to “Attaching the Wireless Module” (➔ page 50).

### Connecting example

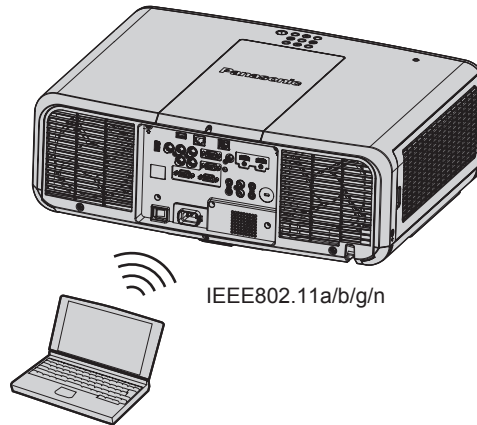

### Connecting example for image transfer

	MIRRORING (Example) Displaying the contents	Image transfer application software (Example) Displaying on multiple screens
Illustration of connection	<p>Projector</p> <p>Miracast</p> <p>Miracast compatible device</p>	<p>Projector</p> <p>Device such as computer that has installed the Panasonic image transfer application software</p>
Input	MIRRORING	Panasonic APPLICATION
Communication method	IEEE802.11n	IEEE802.11a/b/g/n
Connection method	—	Panasonic exclusive method + connection by user
Image transmission method	H.264	Panasonic exclusive method

### Setting of the projector

- 1) Turn on the projector.
- 2) From the main menu, select the [NETWORK/USB] menu → [WIRELESS LAN], and set to anything other than [DISABLE].
- 3) Press the <ENTER> button.
  - The [WIRELESS DETAILED SETUP] screen is displayed.

4) Setting the connection

- For details, refer to [WIRELESS LAN] (➡ page 141).

**Note**

- Wireless LAN and wired LAN cannot be used in the same segment.
- If multiple devices are to be connected, set IP addresses that do not overlap.
- Do not use in ANY connection with SSID set to “any” or “ANY” character string.
- The connection setting in the [WIRELESS DETAILED SETUP] screen is not necessary when the Miracast compatible device and the projector are connected with the mirroring connection. For details regarding the connection using the mirroring function, refer to “Projecting with MIRRORING input” (➡ page 181).

■ Factory default setting

- Following is preset as the factory default setting.

[SIMPLE]	[KEY]	Projxxxx (Same character string as the network ID is set. xxxx is a four-digit number.)
[M-DIRECT]	[IP ADDRESS]	192.168.12.100
	[SUBNET MASK]	255.255.255.0
	[SSID]	M-DIRECTxxxx (xxxx is the last four digits of the network ID.)
	[CHANNEL]	1
[USER]	[KEY]	The same character string as SSID
	[SSID]	Panasonic Projector
	[AUTHENTICATION]	[OPEN]
	[ENCRYPTION]	[NONE]
	[DHCP]	[OFF]
	[IP ADDRESS]	192.168.11.100
	[SUBNET MASK]	255.255.255.0
	[DEFAULT GATEWAY]	192.168.11.1
[DNS1]/[DNS2]	(Blank)	

**Operating the computer**

1) Turn on the computer.

2) Perform the network setting in accordance with the instruction of the network administrator.

- When the [NETWORK/USB] menu → [WIRELESS LAN] is set to [M-DIRECT], set the network setting in the computer to “acquire IP address automatically”.
- When the [NETWORK/USB] menu → [WIRELESS LAN] is set to [USER], set the network items of the computer and the projector in accordance with the instruction of the network administrator.

3) Connect the computer to the network set for the projector.

- In case of the Windows computer, click  in the task tray (bottom right of the computer screen), and select following SSID as the connection destination.
  - When the [NETWORK/USB] menu → [WIRELESS LAN] is set to [M-DIRECT]: The SSID that is set to the projector
  - When the [NETWORK/USB] menu → [WIRELESS LAN] is set to [USER]: The SSID of the access point in use

In case of Mac, click  in the menu bar (top right of the computer screen), and select the SSID set for the projector as the connection destination.

**Note**

- If you use wireless LAN connection utility that is standard for your OS, follow the operation procedure of the utility you use to connect to the network.

# Web control function

Following operation is possible from a computer using the web control function.

- Setting and adjustment of the projector
- Display of the projector status
- Sending E-mail messages when there is a problem with the projector

The projector supports “Crestron Connected™”, and the following application software of Crestron Electronics, Inc. can be used.

- RoomView Express
- Fusion RV
- RoomView Server Edition

## Note

- Communication with an E-mail server is required to use the E-mail function. Confirm that the E-mail can be used beforehand.
- “Crestron Connected™” is a system of Crestron Electronics, Inc. that collectively manages and controls devices on multiple systems connected to a network using a computer.
- For details of the “Crestron Connected™”, visit the website of Crestron Electronics, Inc. (English only.)  
URL <http://www.crestron.com>  
Download “RoomView Express” from the Crestron Electronics, Inc. website. (English only.)  
URL <http://www.crestron.com/getroomview>

## Computer that can be used for setting

To use the web control function, a web browser is required. Confirm that the web browser can be used in advance.

OS	Compatible browser
Windows	Internet Explorer 11.0
Mac OS	Safari 6.0/7.0/8.0/9.0/10.0
iOS	Safari (equipped with version iOS 9 and iOS 10)
Android	Google Chrome (equipped with version Android 4.4/5.0/5.1/6.0/7.0)

## Accessing from the web browser

- 1) Start up the web browser on the computer.
- 2) Enter the IP address set on the projector into the URL entry field of the web browser.
- 3) Enter the user name and the password.
  - The factory default settings are User name: dispuser (user rights)/dispadmin (administer rights); Password: @Panasonic.
  - Change of password is prompted when using the web control function for the first time. Proceed to Step 4). If the web control function was used previously, proceed to Step 7).

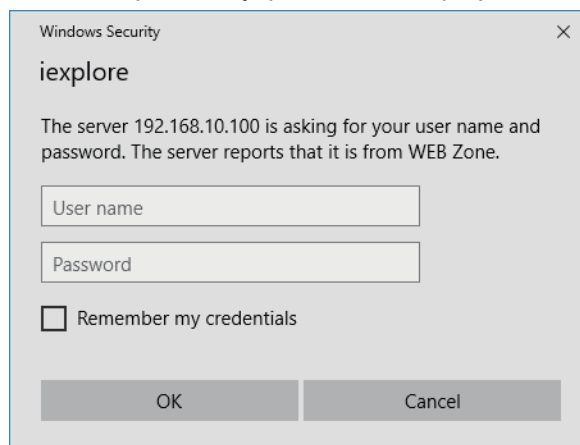

- 4) Click OK.
  - The [Change password] page is displayed.

For user rights

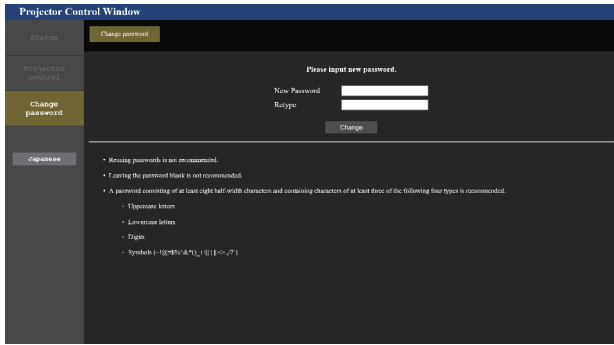

For administrator rights

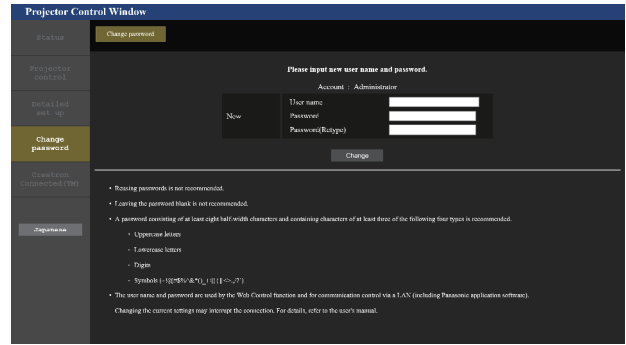

- 5) Enter the new user name and password, and click [Change].
  - The screen in Step 3) is displayed again.
- 6) Enter the new user name and password.
  - Enter the new user name and password set in Step 5).
- 7) Click OK.

Attention

- The entry screen for the user name and password may be hidden by other window that is already opened. In such case, minimize the window in front to display the entry screen.

Note

- To control with the web browser, set the [NETWORK/USB] menu → [NETWORK CONTROL] → [WEB CONTROL] to [ON].
- Do not perform setting or control simultaneously by starting up multiple web browsers. Do not set or control the projector from multiple computers.
- Access will be locked for few minutes when an incorrect password is entered three times consecutively.
- Some items on the projector setting page use the Javascript function of the web browser. Correct control may not be possible when the web browser is set not to use this function.
- If the screen for the web control is not displayed, consult your network administrator.
- While updating the screen for the web control, the screen may appear white for a moment, but it is not a malfunction.
- When the projector is already registered in application software (such as “Multi Monitoring & Control Software” or “Smart Projector Control”) which uses the communication control via LAN, communication with the projector will become impossible if a user name or password for [Administrator] is changed. If a user name or password for [Administrator] is changed, update the registration information of the application software in use.
- Screenshot of a computer  
The size or the display of the screen may be different from this manual depending on the OS or the Web browser, or the type of computer in use.

Rights for each account

The administrator rights allow use of all functions. There is a limitation in the rights that can be used with the user rights. Select the rights depending on the purpose.

The function that has ✓ in the administrator rights/user rights column indicates that it can be operated with that rights.

Item	Function	Administrator rights	User rights	Page
[Projector status]	[Projector status]	✓	✓	161
	Error information page	✓	✓	162
	[Network status]	✓	✓	162
	[Access error log]	✓	—	163
	[Mail error log]	✓	—	163
[Projector control]	[Basic control]	✓	✓	163
	[Detail control]	✓	—	164
[Detailed set up]	[Network config]	✓	—	165
	[Adjust clock]	✓	—	169
	[Ping test]	✓	—	169
	[E-mail set up]	✓	—	170
	[Authentication set up]	✓	—	171
	[ECO management set up]	✓	—	171

Item	Function	Administrator rights	User rights	Page
[Change password]	User name of [Administrator]	✓	—	174
	User name of [User]	✓	—	175
	User name of [Moderator]	✓	—	175
	Password of [Administrator]	✓	—	174
	Password of [User]	✓	✓	175, 175
	Password of [Moderator]	✓	—	175
[Crestron Connected(TM)]	Operation page	✓	—	176
	[Tools]	✓	—	176
	[Info]	✓	—	177
	[Help]	✓	—	177

## Descriptions of items

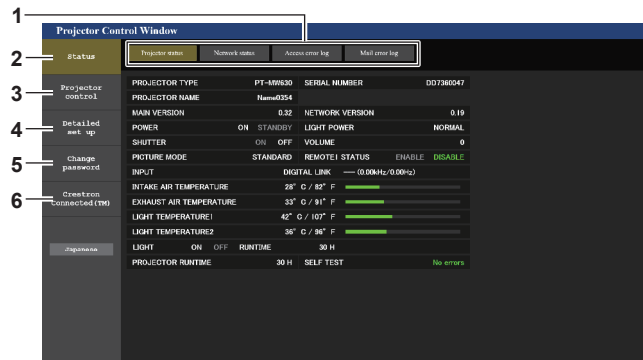

- |  |  |
|--|--|
| <p><b>1 Page tab</b><br/>Switches pages by clicking this item.</p> <p><b>2 [Status]</b><br/>The status of the projector is displayed by clicking this item.</p> <p><b>3 [Projector control]</b><br/>The [Projector control] page is displayed by clicking this item.</p> | <p><b>4 [Detailed set up]</b><br/>The [Detailed set up] page is displayed by clicking this item.</p> <p><b>5 [Change password]</b><br/>The [Change password] page is displayed by clicking this item.</p> <p><b>6 [Crestron Connected(TM)]</b><br/>The operation page of Crestron Connected™ is displayed by clicking this item.</p> |
|--|--|



**[Projector status] page**

Click [Status] → [Projector status].

Display the status of the projector for the following items.

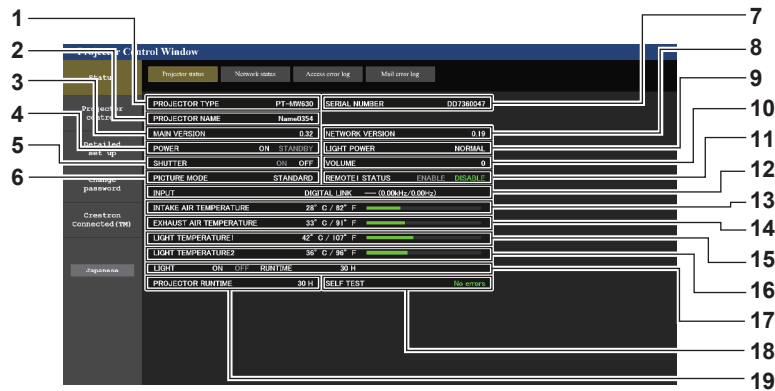

- |   |   |
|---|---|
| <p>1 <b>[PROJECTOR TYPE]</b><br/>Displays the type of the projector.</p> <p>2 <b>[PROJECTOR NAME]</b><br/>Displays the projector name set for the projector.</p> <p>3 <b>[MAIN VERSION]</b><br/>Displays the firmware version of the projector.</p> <p>4 <b>[POWER]</b><br/>Displays the status of the power.</p> <p>5 <b>[SHUTTER]</b><br/>Displays the status of the shutter function ([ON]: Enabled (closed), [OFF]: Disabled (open)).</p> <p>6 <b>[PICTURE MODE]</b><br/>Displays the setting status of [PICTURE MODE].</p> <p>7 <b>[SERIAL NUMBER]</b><br/>Displays the serial number of the projector.</p> <p>8 <b>[NETWORK VERSION]</b><br/>Displays the firmware version of the network microcomputer.</p> <p>9 <b>[LIGHT POWER]</b><br/>Displays the setting status of [LIGHT POWER].</p> <p>10 <b>[VOLUME]</b><br/>Display the volume status.</p> | <p>11 <b>[REMOTE1 STATUS]</b><br/>Displays the control status of the &lt;REMOTE 1 IN&gt; terminal.</p> <p>12 <b>[INPUT]</b><br/>Displays the status of the selected input.</p> <p>13 <b>[INTAKE AIR TEMPERATURE]</b><br/>Displays the status of the intake air temperature of the projector.</p> <p>14 <b>[EXHAUST AIR TEMPERATURE]</b><br/>Displays the status of the exhaust air temperature of the projector.</p> <p>15 <b>[LIGHT TEMPERATURE1]</b><br/>Displays the temperature status of light source 1.</p> <p>16 <b>[LIGHT TEMPERATURE2]</b><br/>Displays the temperature status of light source 2.</p> <p>17 <b>[LIGHT]</b><br/>Displays the lighting status and runtime of the light source.</p> <p>18 <b>[SELF TEST]</b><br/>Displays the self-diagnosis information.</p> <p>19 <b>[PROJECTOR RUNTIME]</b><br/>Displays the runtime of the projector.</p> |
|---|---|

## Error information page

When [Error (Detail)] or [Warning (Detail)] is displayed in the [SELF TEST] display field of the [Projector status] screen, click it to display the content of the error/warning.

- The projector may go into the standby status to protect the projector depending on the contents of the error.

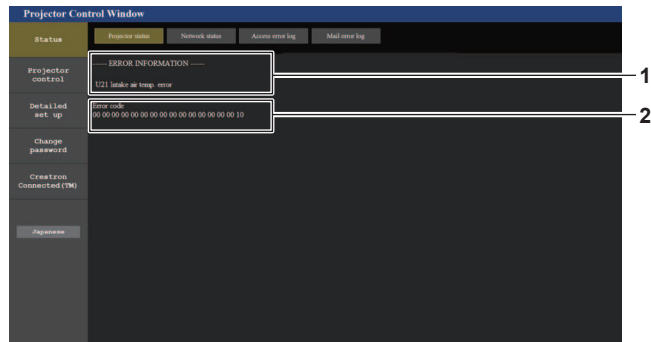

### 1 Display of error information

Displays the alphanumeric symbols and content of errors/warnings that occur.  
For the details of the display content, refer to “[SELF TEST] display” (➔ page 206).

### 2 Error code

## [Network status] page

Click [Status] → [Network status].

The current network setting status is displayed.

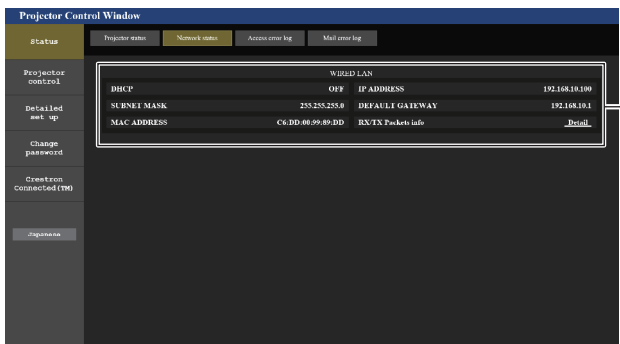

### 1 [WIRED LAN]

Displays the settings of wired LAN.

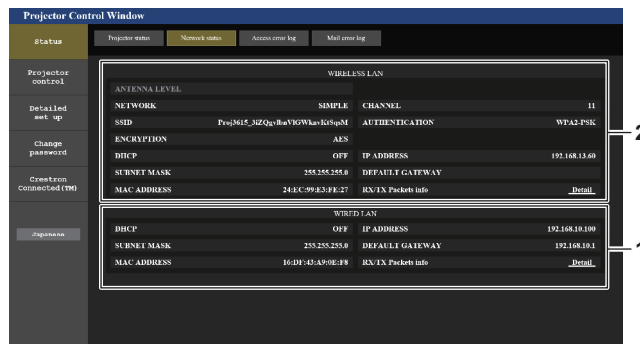

### 2 [WIRELESS LAN]

Displays the settings of wireless LAN when the optional Wireless Module (Model No.: ET-WM300) is attached.

**[Access error log] page**

Click [Status] → [Access error log].

The error log on the web server is displayed such as access to the pages that do not exist or access with unauthorized user names or passwords.

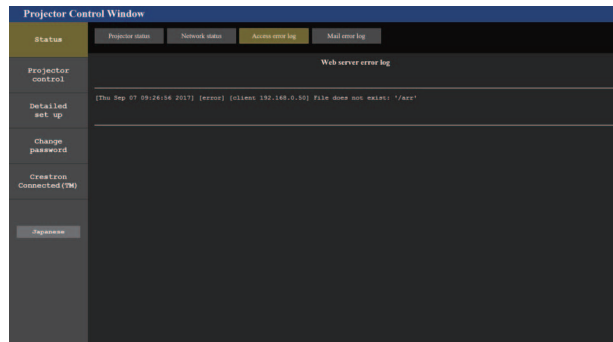

**[Mail error log] page**

Click [Status] → [Mail error log].

E-mail error log is displayed if periodic E-mail sending has failed.

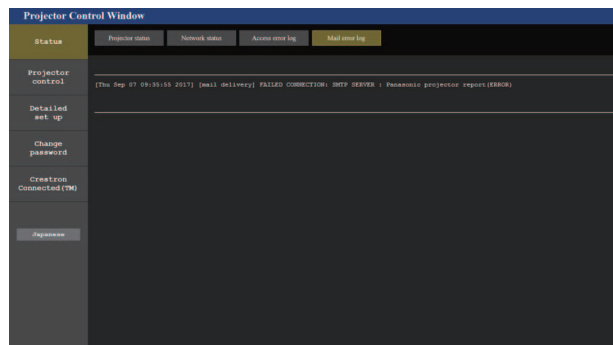

**Note**

- [Access error log] and [Mail error log] display the recent few thousand accesses/requests. All information may not be displayed when many accesses/requests are made at once.
- Logs in [Access error log] and [Mail error log] are deleted from the oldest when exceeding a certain amount.
- Check [Access error log] and [Mail error log] periodically.

**[Basic control] page**

Click [Projector control] → [Basic control].

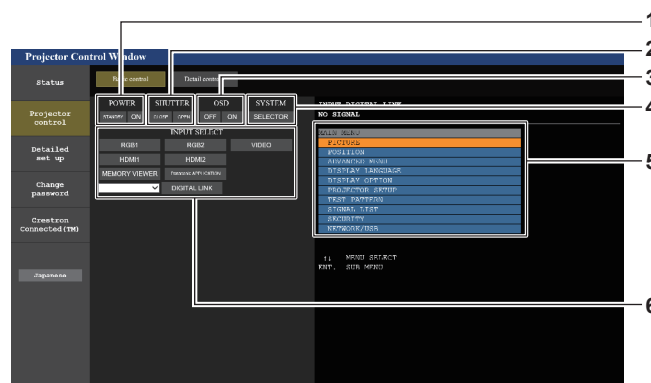

- |   |   |
|---|---|
| <p><b>1 [POWER]</b><br/>Turns off/on the power.</p> <p><b>2 [SHUTTER]</b><br/>Switches whether to use the shutter function (enabled (shutter: closed)/disabled (shutter: open)).</p> <p><b>3 [OSD]</b><br/>Switches on (display)/off (hide) the on-screen display function.</p> | <p><b>4 [SYSTEM]</b><br/>Switches the system method.</p> <p><b>5 On-screen display of the projector</b><br/>Displays the same items as shown on the on-screen display of the projector. You can check or change the settings of the menus. It is displayed even if the on-screen display function is set to off (hide).</p> <p><b>6 [INPUT SELECT]</b><br/>Switches the input signal.</p> |
|---|---|

**[Detail control] page**

Click [Projector control] → [Detail control].

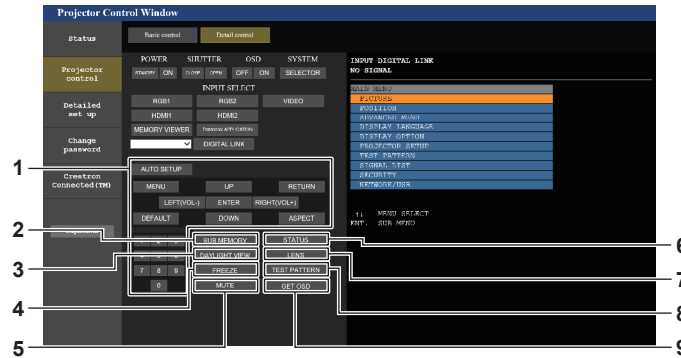

- |   |   |
|---|---|
| <p><b>1 Control of the projector</b><br/>The projector is controlled by clicking the buttons in the same way as the buttons on the remote control. After control, the on-screen display of the projector at the right of the control page is updated.</p> <p><b>2 [SUB MEMORY]</b><br/>Switches the sub memory.</p> <p><b>3 [DAYLIGHT VIEW]</b><br/>Switches the day light view setting.</p> <p><b>4 [FREEZE]</b><br/>Temporarily pauses the image.</p> | <p><b>5 [MUTE]</b><br/>Switches whether to use the mute function.</p> <p><b>6 [STATUS]</b><br/>The [STATUS] screen is displayed on the projected image.</p> <p><b>7 [LENS]</b><br/>Displays the [LENS] page.</p> <p><b>8 [TEST PATTERN]</b><br/>Displays the test pattern.</p> <p><b>9 [GET OSD]</b><br/>Updates the on-screen display of the projector at the right of the control page.</p> |
|---|---|

**[LENS] page**

Click [Projector control] → [Detail control] → [LENS].

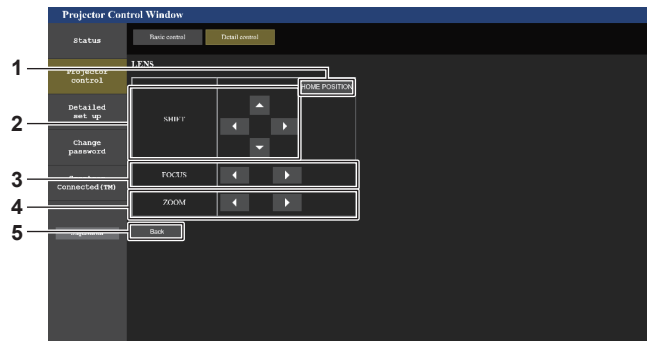

- |   |  |
|---|--|
| <p><b>1 [HOME POSITION]</b><br/>Moves the projection lens to the home position.</p> <p><b>2 [SHIFT]</b><br/>Click ▲▼◀▶ to adjust the lens shift (vertical position and horizontal position).<br/>The adjustment can be performed faster by holding down the button for approximately three seconds or longer.</p> | <p><b>3 [FOCUS]</b><br/>Click ◀▶ to adjust the focus.<br/>The adjustment can be performed faster by holding down the button for approximately three seconds or longer.</p> <p><b>4 [ZOOM]</b><br/>Click ◀▶ to adjust the zoom.<br/>The adjustment can be performed faster by clicking and holding the button for approximately three seconds or longer.</p> <p><b>5 [Back]</b><br/>Returns to the [Detail control] page.</p> |
|---|--|

**[Network config] page**

Click [Detailed set up] → [Network config].

- To use the wireless LAN function with the projector, it is necessary to attach the optional Wireless Module (Model No.: ET-WM300).

For details on how to attach the optional Wireless Module (Model No.: ET-WM300), refer to “Attaching the Wireless Module” (➔ page 50).

**1) Click [Network config].**

- Click [Network config] to display the **[CAUTION!]** screen.

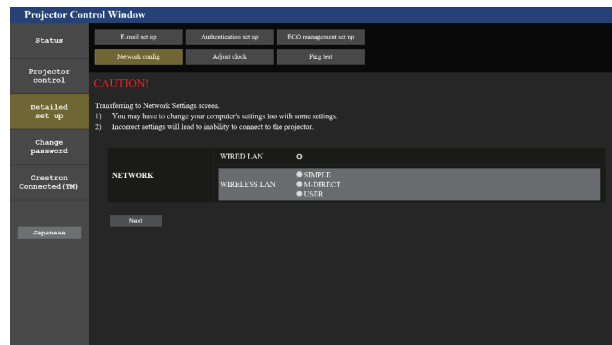

**2) Place a check mark in the item to change the setting.**

- The [WIRELESS LAN] setting can be selected only when the optional Wireless Module (Model No.: ET-WM300) is attached.

**3) Click the [Next] button.**

- The current settings are displayed.

**4) Click the [Change] button.**

- The setting change screen is displayed. Set following the instruction on the screen.

When [WIRED LAN] is selected

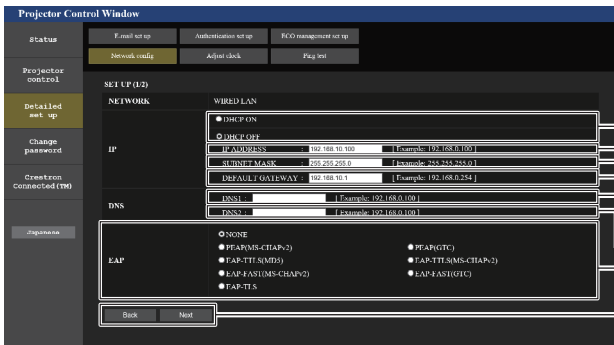

- 1 **[DHCP ON], [DHCP OFF]**  
To enable the DHCP client function, set to [DHCP ON].
- 2 **[IP ADDRESS]**  
Enter the IP address when not using a DHCP server.
- 3 **[SUBNET MASK]**  
Enter the subnet mask when not using a DHCP server.
- 4 **[DEFAULT GATEWAY]**  
Enter the default gateway address when not using a DHCP server.
- 5 **[DNS1]**  
Enter the DNS1 server address.  
Permissible characters for the entry of DNS1 server address (primary):  
Numbers (0 - 9), period (.)  
(Example: 192.168.0.253)
- 6 **[DNS2]**  
Enter the DNS2 server address.  
Available characters for the entry of DNS2 server address (secondary):  
Numbers (0 - 9), period (.)  
(Example: 192.168.0.254)
- 7 **[EAP]**  
Select the EAP set in the RADIUS server.
- 8 **[Back], [Next]**  
Click the [Back] button to return to the previous screen. When [EAP] is set to anything other than [NONE], clicking the [Next] button will advance to next page. When [EAP] is set to [NONE], clicking the [Next] button will display the screen to confirm the setting. Click the [Submit] button to update the setting.
- 9 **[USER NAME]**  
Enter the user name to be used for authentication in single-byte alphanumeric characters (excluding the space). (Maximum of 64 characters)
- 10 **[PASSWORD]**  
Enter the password to be used for authentication in single-byte alphanumeric characters. (Maximum of 64 characters)
- 11 **[Back], [Next]**  
Click the [Back] button to return to the original screen. Click the [Next] button to display the setting confirmation screen. Click the [Submit] button to update the setting.
- 12 **[DIGITAL CERTIFICATE]**  
Registers the electronic certificate to be used for authentication (file extension: PFX).
- 13 **[CA CERTIFICATE]**  
Registers the CA certificate to be used for authentication (file extension: CER).

**Note**

- When you use the “Forward” and “Back” functions of your browser, a warning message “Page has Expired” may appear. In that case, click [Network config] again since the following operation will not be guaranteed.
- The connection may be disconnected when the LAN setting is changed while connected with LAN.

When [SIMPLE] (wireless LAN) is selected

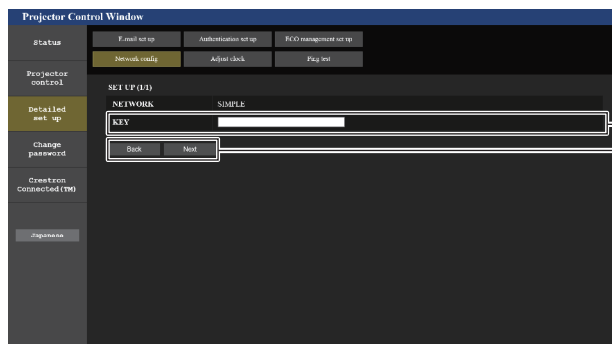

- 1 **[KEY]**  
Set the key to be used with simple.  
Enter 8 to 15 characters of single-byte alphanumeric.
- 2 **[Back], [Next]**  
Click the [Back] button to return to the previous screen. Click the [Next] button to display the screen to confirm the setting. Click the [Submit] button to update the setting.

When [M-DIRECT] (wireless LAN) is selected

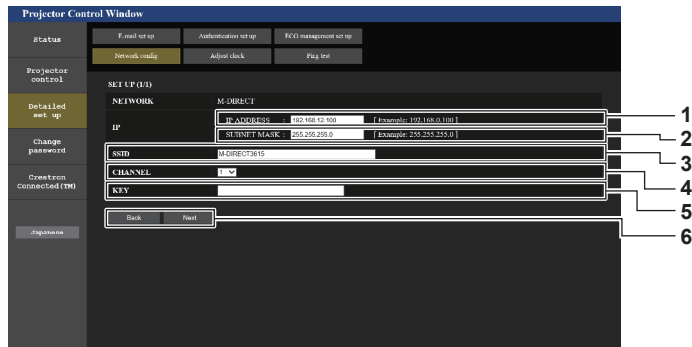

- |  |  |
|--|--|
| <p><b>1 [IP ADDRESS]</b><br/>Enter the IP address.</p> <p><b>2 [SUBNET MASK]</b><br/>Enter the subnet mask.</p> <p><b>3 [SSID]</b><br/>Set SSID to be used with M-DIRECT with single-byte alphanumeric.</p> <p><b>4 [CHANNEL]</b><br/>Select the channel to be used with M-DIRECT.</p> | <p><b>5 [KEY]</b><br/>Set the key to be used with M-DIRECT.<br/>Enter 8 to 63 characters of ASCII character, or 64-digit hexadecimal number.</p> <p><b>6 [Back], [Next]</b><br/>Click the [Back] button to return to the previous screen. Click the [Next] button to display the screen to confirm the setting. Click the [Submit] button to update the setting.</p> |
|--|--|

**Note**

- Do not use in ANY connection with SSID set to “any” or “ANY” character string.

When [USER] (wireless LAN) is selected

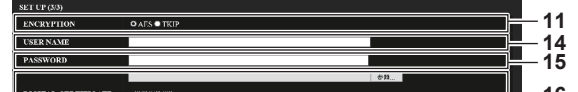
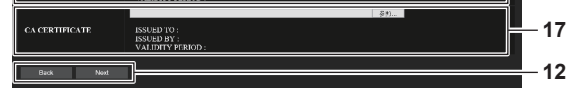
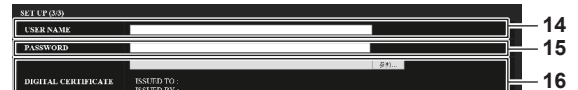
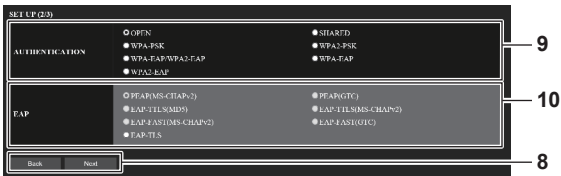
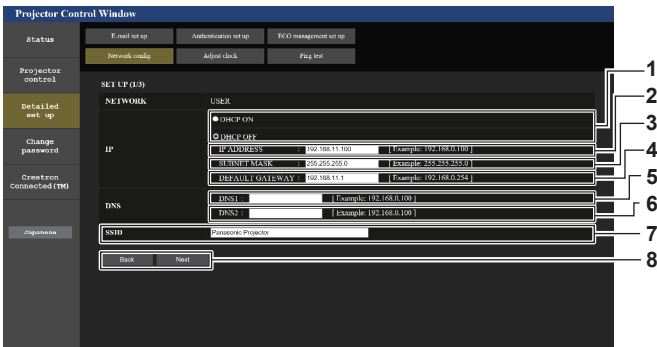

- 1 **[DHCP ON], [DHCP OFF]**  
To enable the DHCP client function, set [DHCP ON].
- 2 **[IP ADDRESS]**  
Enter the IP address if the DHCP server is not used.
- 3 **[SUBNET MASK]**  
Enter the subnet mask if the DHCP server is not used.
- 4 **[DEFAULT GATEWAY]**  
Enter the default gateway address if the DHCP server is not used.
- 5 **[DNS1]**  
Enter the DNS1 server address.  
Permissible characters for the entry of DNS1 server address (primary):  
Numbers (0 - 9), period (.)
- 6 **[DNS2]**  
Enter the DNS2 server address.  
Available characters for the entry of DNS2 server address (secondary):  
Numbers (0 - 9), period (.)
- 7 **[SSID]**  
Enter the same string as the SSID registered to the access point.
- 8 **[Back], [Next]**  
Click the [Back] button to return to the previous screen. Click the [Next] button to proceed to the next screen.
- 9 **[AUTHENTICATION]**  
Select the user authentication method used in the network to which the projector is connected.

- 10 **[EAP]**  
Select the EAP set for the RADIUS server.
- 11 **[ENCRYPTION]**  
Select the encryption method used for the communication between the projector and the network.
- 12 **[Back], [Next]**  
Click the [Back] button to return to the previous screen. Click the [Next] button to display the screen to confirm the setting. Click the [Submit] button to update the setting.
- 13 **[KEY]**  
Set the key to be used with USER.  
Enter 8 to 63 characters of ASCII character, or 64-digit hexadecimal number.
- 14 **[USER NAME]**  
Enter the user name to be used for authentication in single-byte alphanumeric characters (excluding the space). (Maximum of 64 characters)
- 15 **[PASSWORD]**  
Enter the password to be used for authentication in single-byte alphanumeric characters. (Maximum of 64 characters)
- 16 **[DIGITAL CERTIFICATE]**  
Registers the electronic certificate to be used for authentication (file extension: PFX).
- 17 **[CA CERTIFICATE]**  
Registers the CA certificate to be used for authentication (file extension: CER).

**Note**

- The content of setting varies depending on the authentication method of the wireless LAN to be connected.



**[Adjust clock] page**

Click [Detailed set up] → [Adjust clock].

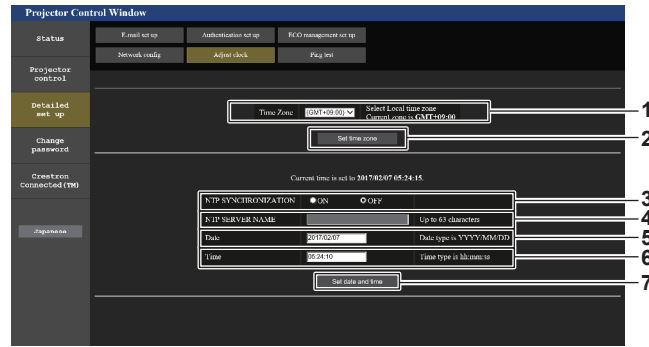

- |  |   |
|--|---|
| <p>1 <b>[Time Zone]</b><br/>Select the time zone.</p> <p>2 <b>[Set time zone]</b><br/>Updates the time zone setting.</p> <p>3 <b>[NTP SYNCHRONIZATION]</b><br/>Set to [ON] when setting the date and time automatically.</p> <p>4 <b>[NTP SERVER NAME]</b><br/>Enter the IP address or server name of the NTP server when you set to adjust the date and time manually.<br/>(To enter the server name, the DNS server needs to be set up.)</p> | <p>5 <b>[Date]</b><br/>Enter the date to be changed.</p> <p>6 <b>[Time]</b><br/>Enter the time to be changed.</p> <p>7 <b>[Set date and time]</b><br/>Updates the date and time settings.</p> |
|--|---|

**Note**

- The replacement of the battery inside the projector is required when the time goes out of alignment right after correcting the time. Consult your dealer.

**[Ping test] page**

Check whether the network is connected to the E-mail server, POP server, DNS server, etc.

Click [Detailed set up] → [Ping test].

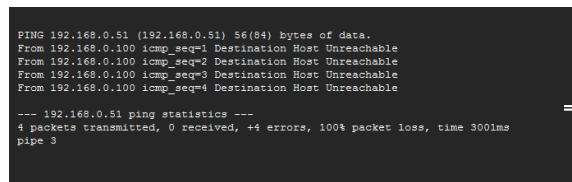
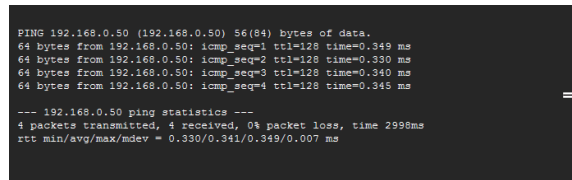
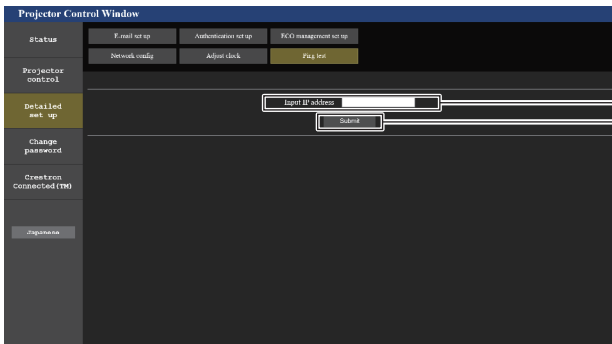

- |  |  |
|--|--|
| <p>1 <b>[Input IP address]</b><br/>Enter the IP address of the server to be tested.</p> <p>2 <b>[Submit]</b><br/>Executes the connection test.</p> | <p>3 <b>Example of display when the connection has succeeded</b></p> <p>4 <b>Example of display when the connection has failed</b></p> |
|--|--|

[E-mail set up] page

When there is a problem or the runtime of the light source reaches the preset value, an E-mail can be sent to previously set E-mail addresses (up to two addresses).

Click [Detailed set up] → [E-mail set up].

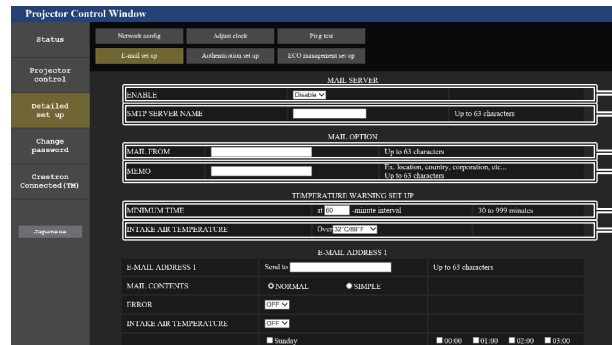

- 1 **[ENABLE]**  
Select [Enable] to use the E-mail function.
- 2 **[SMTP SERVER NAME]**  
Enter the IP address or the server name of the E-mail server (SMTP). To enter the server name, the DNS server needs to be set up.
- 3 **[MAIL FROM]**  
Enter the E-mail address of the projector. (Up to 63 characters in single byte)
- 4 **[MEMO]**  
Enter information such as the location of the projector that notifies the sender of the E-mail. (Up to 63 characters in single byte)

- 5 **[MINIMUM TIME]**  
Change the minimum interval for the temperature warning E-mail. The default value is 60 minutes. In this case, another E-mail will not be sent for 60 minutes after sending the temperature warning E-mail even if it reaches the warning temperature.
- 6 **[INTAKE AIR TEMPERATURE]**  
Change the temperature setting for the temperature warning mail. A temperature warning E-mail is sent when the temperature exceeds this value.

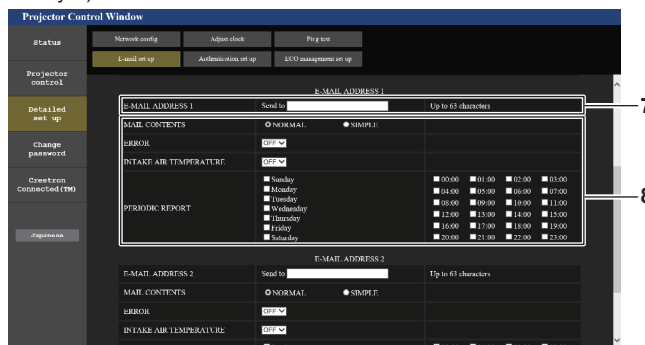

- 7 **[E-MAIL ADDRESS 1], [E-MAIL ADDRESS 2]**  
Enter the E-mail address to be sent. Leave [E-MAIL ADDRESS 2] blank when two E-mail addresses are not to be used.



- 8 **Settings of the conditions to send E-mail**  
Select the conditions to send E-mail.  
**[MAIL CONTENTS]:**  
Select either [NORMAL] or [SIMPLE].  
**[ERROR]:**  
Send an E-mail when an error occurred in the self-diagnosis.  
**[INTAKE AIR TEMPERATURE]:**  
Send an E-mail when the intake air temperature has reached the value set at the above field.  
**[PERIODIC REPORT]:**  
Place a check mark on this to send an E-mail periodically. It will be sent on the days and time with the check mark.
- 9 **[Submit]**  
Update the settings.

**[Authentication set up] page**

Set the authentication items when POP authentication or SMTP authentication is necessary to send an E-mail. Click [Detailed set up] → [Authentication set up].

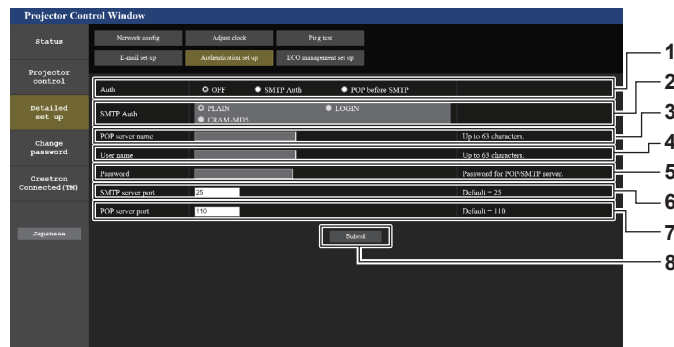

- |  |   |
|--|---|
| <p><b>1 [Auth]</b><br/>Select the authentication method specified by your Internet service provider.</p> <p><b>2 [SMTP Auth]</b><br/>Set when the SMTP authentication is selected.</p> <p><b>3 [POP server name]</b><br/>Enter the POP server name.<br/>Allowed characters:<br/>Alphanumerics (A - Z, a - z, 0 - 9)<br/>Minus sign (-) and period (.)</p> <p><b>4 [User name]</b><br/>Enter the user name for the POP server or the SMTP server.</p> | <p><b>5 [Password]</b><br/>Enter the password for the POP server or the SMTP server.</p> <p><b>6 [SMTP server port]</b><br/>Enter the port number of the SMTP server.<br/>(Normally 25)</p> <p><b>7 [POP server port]</b><br/>Enter the port number of the POP server.<br/>(Normally 110)</p> <p><b>8 [Submit]</b><br/>Update the settings.</p> |
|--|---|

**[ECO management set up] page**

Settings related to the ECO management function of the projector can be made. Click [Detailed set up] → [ECO management set up].

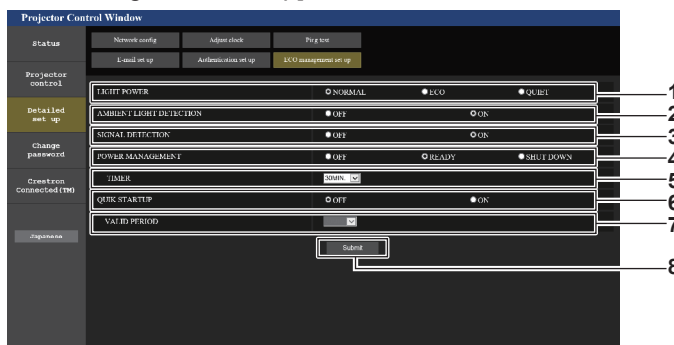

- |   |  |
|---|--|
| <p><b>1 [LIGHT POWER]</b><br/>Displays the [LIGHT POWER] setting.</p> <p><b>2 [AMBIENT LIGHT DETECTION]</b><br/>Enables ([ON])/disables ([OFF]) the ambient light detection function.</p> <p><b>3 [SIGNAL DETECTION]</b><br/>Enables ([ON])/disables ([OFF]) the signal detection function.</p> <p><b>4 [POWER MANAGEMENT]</b><br/>Displays the [Power management] setting.</p> | <p><b>5 [TIMER]</b><br/>Select the time until the light source is turned off after the power management function is operated.</p> <p><b>6 [QUICK STARTUP]</b><br/>Displays the [QUICK STARTUP] setting.</p> <p><b>7 [VALID PERIOD]</b><br/>Select the valid period until the [QUICK STARTUP] function is disabled after going into the standby mode.</p> <p><b>8 [Submit]</b><br/>Updates the setting.</p> |
|---|--|

**Note**

- For details of each setting item, refer to the [PROJECTOR SETUP] menu of the projector → [ECO MANAGEMENT].

## Contents of E-mail sent

### Example of the E-mail sent when E-mail is set

The following E-mail is sent when the E-mail settings have been established.

```

=== Panasonic projector report(CONFIGURE) ===
Projector Type      : PT-MZ670
Serial No          : 123456789

----- E-mail setup data -----
TEMPERATURE WARNING SETUP
MINIMUM TIME      at [ 60] minutes interval
INTAKE AIR TEMPERATURE      Over [ 32 degC / 89 degF ]

ERROR      [ ON ]
INTAKE AIR TEMPERATURE      [ ON ]
PERIODIC REPORT
Sunday     [ OFF ]      Monday   [ OFF ]      Tuesday  [ OFF ]      Wednesday [ OFF ]
Thursday  [ OFF ]      Friday   [ OFF ]      Saturday [ OFF ]

00:00 [ OFF ]  01:00 [ OFF ]  02:00 [ OFF ]  03:00 [ OFF ]
04:00 [ OFF ]  05:00 [ OFF ]  06:00 [ OFF ]  07:00 [ OFF ]
08:00 [ OFF ]  09:00 [ OFF ]  10:00 [ OFF ]  11:00 [ OFF ]
12:00 [ OFF ]  13:00 [ OFF ]  14:00 [ OFF ]  15:00 [ OFF ]
16:00 [ OFF ]  17:00 [ OFF ]  18:00 [ OFF ]  19:00 [ OFF ]
20:00 [ OFF ]  21:00 [ OFF ]  22:00 [ OFF ]  23:00 [ OFF ]

----- Error information -----

Error code :
00 00 00 00 00 00 00 00 00 00 00 00 00 00 00 00

Intake air temperature : 30 degC / 86 degF
Exhaust air temperature : 50 degC / 122 degF
Light temperature1      : 31 degC / 87 degF
Light temperature2      : 31 degC / 87 degF
PROJECTOR RUNTIME       10 H
POWER ON                 5 times
LIGHT RUNTIME           25 H
LIGHT ON                 6 times

----- Current status -----
MAIN VERSION             1.00
NETWORK VERSION         1.00
SUB VERSION              1.00
LIGHT STATUS            LIGHT=OFF
INPUT                   DIGITAL LINK
REMOTE1 STATUS          ENABLE

----- Wired network configuration -----
DHCP Client             OFF
IP address              192.168.0.100
MAC address              7E:D6:57:86:D9:0F

----- Wireless network configuration -----
DHCP Client             OFF
IP address              192.168.13.166
MAC address              7C:B7:33:1C:9B:98

Mon Jan 01 12:34:56 20XX

----- Memo -----

```

### Note

- Information of the wireless LAN is displayed when the optional Wireless Module (Model No.: ET-WM300) is attached.

Example of the E-mail sent for an error

The following E-mail is sent when an error has occurred.

```

=== Panasonic projector report(ERROR) ===
Projector Type      : PT-MZ670
Serial No          : 123456789

---- E-mail setup data ----
TEMPERATURE WARNING SETUP
MINIMUM TIME      at [ 60] minutes interval
INTAKE AIR TEMPERATURE Over [ 32 degC / 89 degF ]

ERROR            [ ON ]
INTAKE AIR TEMPERATURE [ ON ]
PERIODIC REPORT
Sunday          [ OFF ]   Monday    [ OFF ]   Tuesday    [ OFF ]   Wednesday  [ OFF ]
Thursday       [ OFF ]   Friday     [ OFF ]   Saturday   [ OFF ]

00:00 [ OFF ]  01:00 [ OFF ]  02:00 [ OFF ]  03:00 [ OFF ]
04:00 [ OFF ]  05:00 [ OFF ]  06:00 [ OFF ]  07:00 [ OFF ]
08:00 [ OFF ]  09:00 [ OFF ]  10:00 [ OFF ]  11:00 [ OFF ]
12:00 [ OFF ]  13:00 [ OFF ]  14:00 [ OFF ]  15:00 [ OFF ]
16:00 [ OFF ]  17:00 [ OFF ]  18:00 [ OFF ]  19:00 [ OFF ]
20:00 [ OFF ]  21:00 [ OFF ]  22:00 [ OFF ]  23:00 [ OFF ]

---- Error information ----
U21 Intake air temp. error

Error code :
00 00 00 00 00 00 00 00 00 00 00 00 00 00 10

Intake air temperature      : 30 degC / 86 degF
Exhaust air temperature    : 50 degC / 122 degF
Light temperature1         : 31 degC / 87 degF
Light temperature2         : 31 degC / 87 degF
PROJECTOR RUNTIME          : 10 H
POWER ON                   : 5 times
LIGHT RUNTIME              : 25 H
LIGHT ON                   : 6 times

---- Current status ----
MAIN VERSION                1.00
NETWORK VERSION             1.00
SUB VERSION                 1.00
LIGHT STATUS                LIGHT=OFF
INPUT                      DIGITAL LINK
REMOTE1 STATUS              ENABLE

---- Wired network configuration ----
DHCP Client                 OFF
IP address                  192.168.0.100
MAC address                  7E:D6:57:86:D9:0F

---- Wireless network configuration ----
DHCP Client                 OFF
IP address                  192.168.13.166
MAC address                  7C:B7:33:1C:9B:98

Mon Jan 01 12:34:56 20XX

---- Memo ----

```

Note

- Information of the wireless LAN is displayed when the optional Wireless Module (Model No.: ET-WM300) is attached.

**[Change password] page**

Click [Change password].

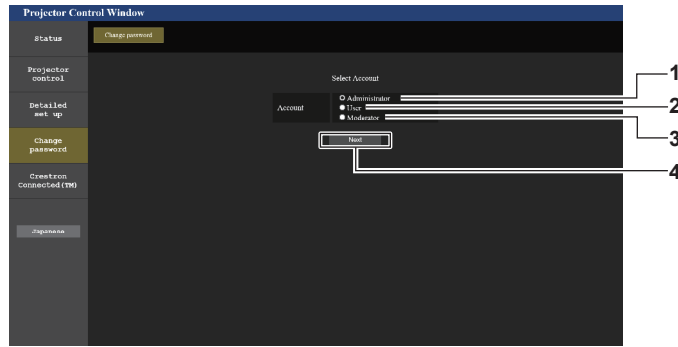

- |   |  |
|---|--|
| <p>1 <b>[Administrator]</b><br/>Used to change the setting of the [Administrator].</p> <p>2 <b>[User]</b><br/>Used to change the setting of the [User].</p> | <p>3 <b>[Moderator]</b><br/>Select this item to change the [Moderator] setting.</p> <p>4 <b>[Next]</b><br/>Used to change the setting of the password.</p> |
|---|--|

**Note**

- The [Moderator] account is used when operating in the moderator mode when the MIRRORING input or the Panasonic APPLICATION input is selected.

**[Administrator] account**

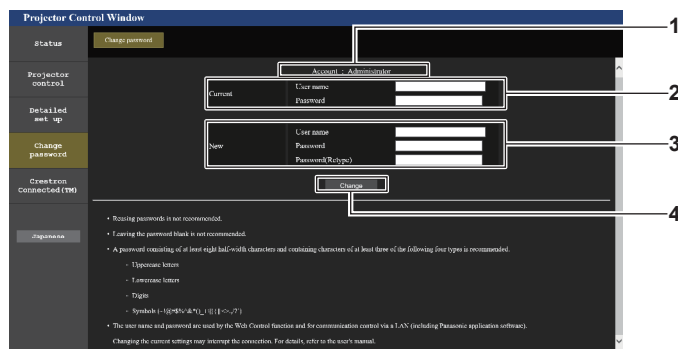

- |   |   |
|---|---|
| <p>1 <b>[Account]</b><br/>Displays the account to change.</p> <p>2 <b>[Current]</b><br/><b>[User name]:</b><br/>Enter the user name before the change.<br/><b>[Password]:</b><br/>Enter the current password.</p> | <p>3 <b>[New]</b><br/><b>[User name]:</b><br/>Enter the desired new user name. (Up to 16 characters in single byte)<br/><b>[Password]:</b><br/>Enter the desired new password. (Up to 16 characters in single byte)<br/><b>[Password(Retyp)]:</b><br/>Enter the desired new password again.</p> <p>4 <b>[Change]</b><br/>Determines the change of password.</p> |
|---|---|

**Note**

- When the projector is already registered in application software (such as “Multi Monitoring & Control Software” or “Smart Projector Control”) which uses the communication control via LAN, communication with the projector will become impossible if a user name or password for [Administrator] is changed. If a user name or password for [Administrator] is changed, update the registration information of the application software in use.

**[User] and [Moderator]**

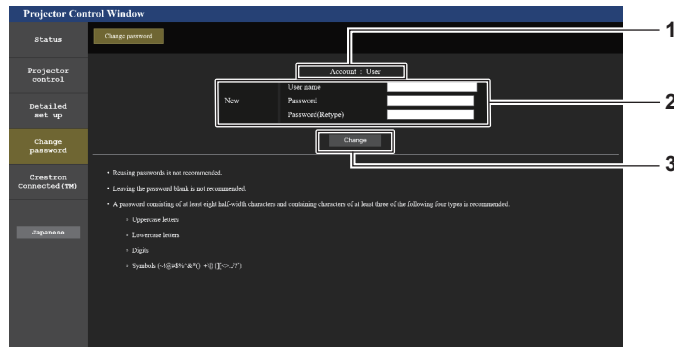

- |   |   |
|---|---|
| <p><b>1 [Account]</b><br/>Displays the account to change.</p> <p><b>2 [New]</b><br/><b>[User name]:</b><br/>Enter the desired new user name. (Up to 16 characters in single byte)<br/><b>[Password]:</b><br/>Enter the desired new password. (Up to 16 characters in single byte)<br/><b>[Password(Retyp)]:</b><br/>Enter the desired new password again.</p> | <p><b>3 [Change]</b><br/>Determines the change of password.</p> |
|---|---|

**[Change password] (For user rights)**

Only the change of password is enabled under the user rights.

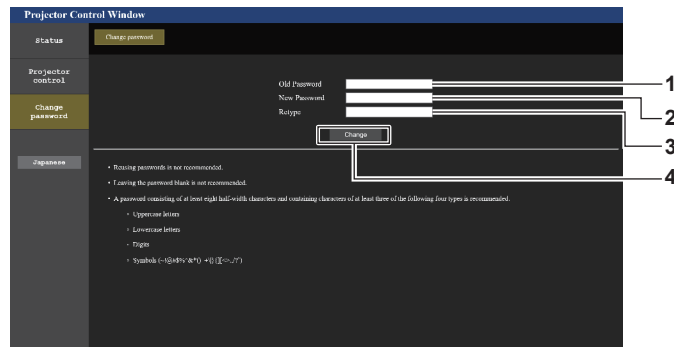

- |  |  |
|--|--|
| <p><b>1 [Old Password]</b><br/>Enter the current password.</p> <p><b>2 [New Password]</b><br/>Enter the desired new password. (Up to 16 characters in single byte)</p> | <p><b>3 [Retype]</b><br/>Enter the desired new password again.</p> <p><b>4 [Change]</b><br/>Determines the change of password.</p> |
|--|--|

**Note**

- To change the account of the [Administrator], entry of [User name] and [Password] in [Current] is required.

**[Crestron Connected(TM)] page**

The projector can be monitored/controlled with Crestron Connected™. It is necessary to access with the administrator rights to start the operation screen of Crestron Connected™ from the web control screen. (The [Crestron Connected(TM)] button is not displayed in the Web control screen with the user rights.) The operation page of Crestron Connected™ is displayed by clicking [Crestron Connected(TM)]. It is not displayed if Adobe Flash Player is not installed on your computer, or the browser you use does not support Flash. In such a case, click [Back] in the operation page to go back to the previous page.

Operation page



- |   |   |
|---|---|
| <p><b>1 [Tools], [Info], [Help]</b><br/>Tabs for selecting the setting, information, or help page of the projector.</p> <p><b>2 [POWER]</b><br/>Turns off/on the power.</p> <p><b>3 [VOL DOWN], [VOL UP]</b><br/>Adjusts the volume.</p> <p><b>4 [SHUTTER]</b><br/>Switches whether to use the shutter function (enabled (shutter: closed)/disabled (shutter: open)).</p> | <p><b>5 [Input Select]</b><br/>Controls input selection.<br/>Not available when the power of the projector is turned off.</p> <p><b>6 Menu screen control buttons</b><br/>Navigates the menu screen.</p> <p><b>7 Freeze/image quality adjustment</b><br/>Controls items related to freeze/image quality.</p> <p><b>8 [Back]</b><br/>Returns to the previous page.</p> |
|---|---|

[Tools] page

Click [Tools] in the operation page.



- |   |  |
|---|--|
| <p><b>1 [Control System]</b><br/>Set the information required for communicating with the controller to be connected with the projector.</p> <p><b>2 [User Password]</b><br/>Set the user rights password for the operation page of Crestron Connected™.</p> <p><b>3 [Admin Password]</b><br/>Set the administrator rights password for the operation page of Crestron Connected™.</p> | <p><b>4 Network status</b><br/>Displays the settings of wired LAN.<br/><b>[DHCP]</b><br/>Displays the current setting.<br/><b>[Ip Address]</b><br/>Displays the current setting.<br/><b>[Subnet Mask]</b><br/>Displays the current setting.<br/><b>[Default Gateway]</b><br/>Displays the current setting.<br/><b>[DNS Server]</b><br/>Displays the current setting.</p> <p><b>5 [Exit]</b><br/>Returns to the operation page.</p> |
|---|--|



**[Info] page**

Click [Info] in the operation page.

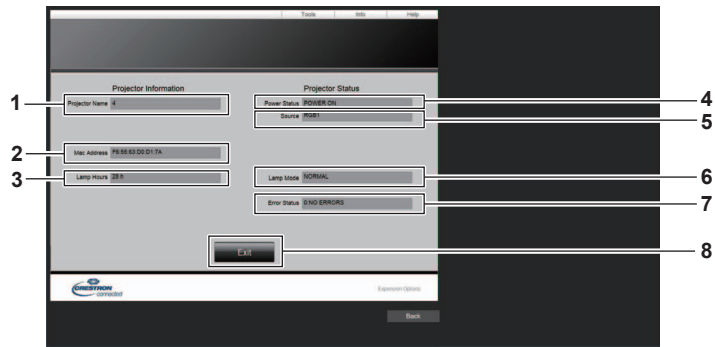

- |   |   |
|---|---|
| <p><b>1 [Projector Name]</b><br/>Displays the projector name.</p> <p><b>2 [Mac Address]</b><br/>Displays the MAC address.</p> <p><b>3 [Lamp Hours]</b><br/>Displays the runtime of the light source.</p> <p><b>4 [Power Status]</b><br/>Displays the status of the power.</p> | <p><b>5 [Source]</b><br/>Displays the selected input.</p> <p><b>6 [Lamp Mode]</b><br/>Displays the [LIGHT POWER] setting.</p> <p><b>7 [Error Status]</b><br/>Displays the error status.</p> <p><b>8 [Exit]</b><br/>Returns to the operation page.</p> |
|---|---|

**[Help] page**

Click [Help] in the operation page.  
The [Help Desk] window is displayed.

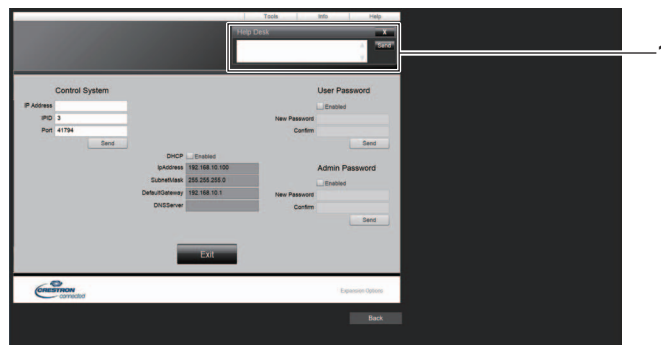

- 1 [Help Desk]**  
A message can be sent/received with the administrator using the Crestron Connected™.

# Projecting with Panasonic APPLICATION input

Using the Panasonic application, the image sent from a device connected via LAN can be displayed as a projected image.

## Application that can be used

The image transfer application software used for Panasonic APPLICATION input are as follows.

- Wireless Manager ME6.4
- Plug and Share
- Wireless Projector for iOS, Wireless Projector for Android

### Note

- For details of the installation method of the application software, connection method to the projector, and operation method, refer to the Panasonic website (<https://panasonic.net/cns/projector/>).
- “Plug and Share” allows to write the connection information between the image transfer application software “Plug and Share”, and the projector and the USB memory by attaching the USB memory to the <VIEWER/PAIRING> terminal of the projector. By connecting this paired USB memory to the USB terminal of the Windows computer or Mac, “Plug and Share” will automatically start up and perform the connection operation to the projector. For details on the pairing method, refer to “Using the pairing function” (➡ page 193).

## Connecting the device

### 1) Press the <NETWORK/USB> button to switch the input to Panasonic APPLICATION.

- Every time the <NETWORK/USB> button is pressed, the input will switch in the order of MEMORY VIEWER, Panasonic APPLICATION, and MIRRORING. Press the <NETWORK/USB> button until the input switches to Panasonic APPLICATION.
- The standby screen is displayed once the input is switched to Panasonic APPLICATION.
- The standby screen differs depending on the setting in the [NETWORK/USB] menu → [WIRELESS LAN]. For details on the standby screen, refer to “Description of the standby screen” (➡ page 179).

### 2) Connect the device with the image transfer application software started to the projector.

- The image sent to the projector by the operation on the device is displayed as the projected image.

### Note

- For details of the connection method to the projector using the application software, refer to the Operation Instruction of each application software.
- When the <AUTO SETUP/CANCEL> button on the remote control or the <LENS/CANCEL> button on the control panel is pressed while displaying the image from the device, the information such as the network ID, the projector name, or the QR code is displayed on the screen. For details of these information, refer to “Description of the standby screen” (➡ page 179).

## Ending the connection with the device

### 1) Perform disconnection process in the device side.

- Once the connection is disconnected, the standby screen is displayed.

### Note

- It may take some time for the standby screen to display when the connection is ended forcefully by turning off the device, etc., without performing an appropriate disconnection process.

## Description of the standby screen

The standby screen differs depending on the setting in the [NETWORK/USB] menu → [WIRELESS LAN].

### ■ When [WIRELESS LAN] is set to [SIMPLE]

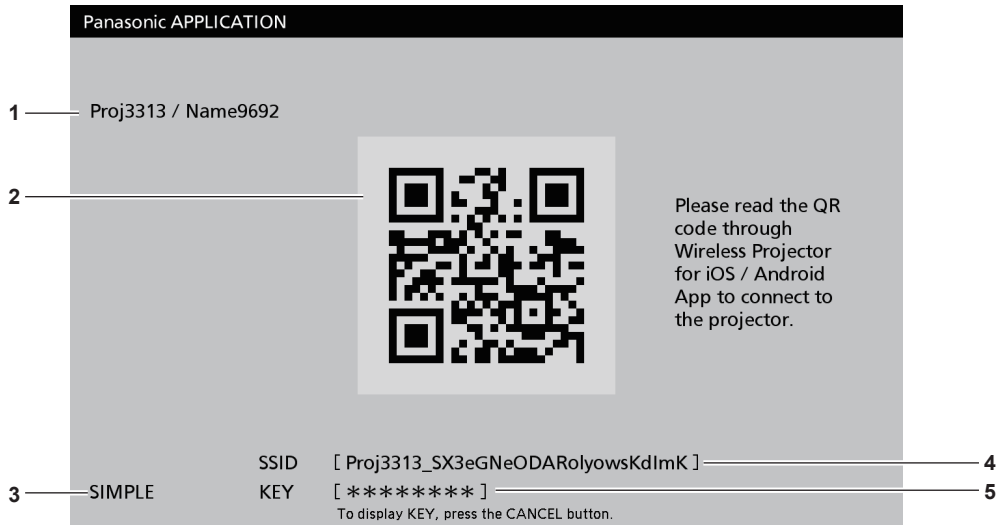

**1 Network ID/projector name**

Displays the network ID of the projector and the projector name set for this projector.

**2 QR code**

The connection information to connect to the projector using the “Wireless Projector”.

**3 Connection method**

Displays the setting in the [NETWORK/USB] menu → [WIRELESS LAN]. In this case, it is displayed as [SIMPLE].

**4 [SSID]**

Displays the SSID to be used.

**5 [Key]**

Displays the key to be used.

It is normally displayed as \*. Press the <AUTO SETUP/ CANCEL> button on the remote control or the <LENS/ CANCEL> button on the control panel to display the character string.

### Note

- The QR code is used when connecting to the projector using the “Wireless Projector”.

### ■ When [WIRELESS LAN] is set to [SIMPLE]

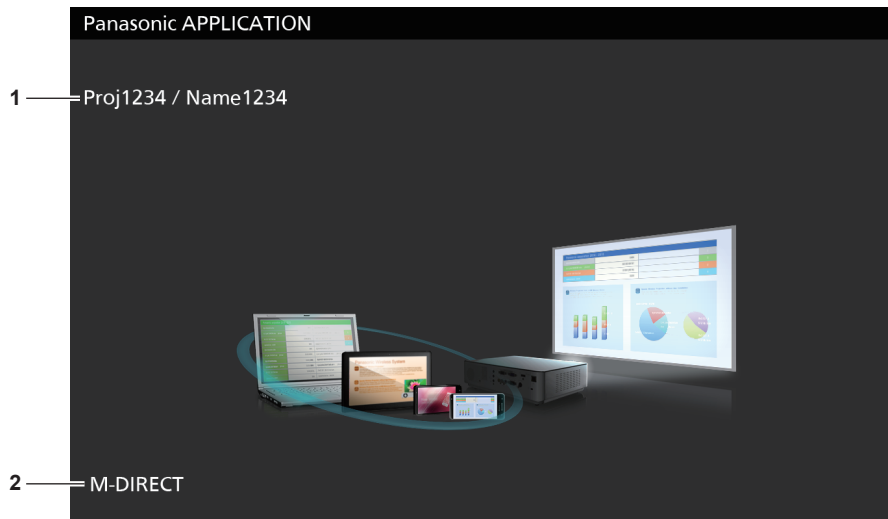

**1 Network ID/projector name**

Displays the network ID of the projector and the projector name set for this projector.

**2 Connection method**

Displays the setting in the [NETWORK/USB] menu → [WIRELESS LAN]. In this case, it is displayed as [M-DIRECT] or [USER].

## Using the moderator mode in the Panasonic APPLICATION input

When using the projector in the moderator mode, the moderator can specify the image to allow to display by operating the projector when multiple devices are connected to the projector.

- 1) Set the [NETWORK/USB] menu → [Panasonic APPLICATION] → [MODERATOR MODE] to [ON].
- 2) Press the <NETWORK/USB> button to switch the input to Panasonic APPLICATION.
  - Every time the <NETWORK/USB> button is pressed, the input will switch in the order of MEMORY VIEWER, Panasonic APPLICATION, and MIRRORING. Press the <NETWORK/USB> button until the input switches to Panasonic APPLICATION.
  - The screen to display in thumbnail view is displayed once the input is switched to Panasonic APPLICATION.
- 3) Connect the device with the image transfer application software started to the projector.
  - The image sent to the projector by the operation on the device is displayed in thumbnail view.
  - Images from maximum of 16 devices can be displayed in the screen in thumbnail view.

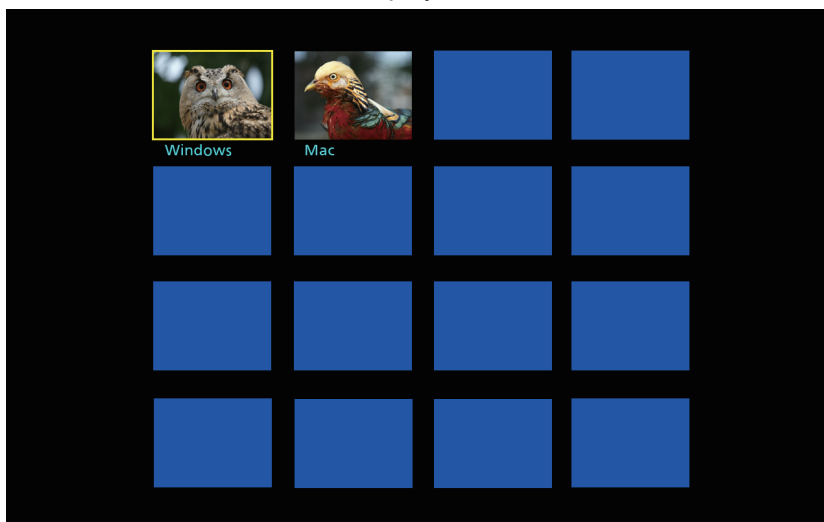

- 4) Press ▲▼◀▶ to select the device to display the image in full screen, and press the <ENTER> button.
  - Select the image to display in full screen from the images displayed in thumbnail.
  - After a while, the selected image is displayed in full screen.

### Note

- For details of the connection method to the projector and operation method using the application software, refer to the Operating Instruction of each application software.
- For details on moderator mode setting, refer to the [NETWORK/USB] menu → [Panasonic APPLICATION] (➡ page 147).
- Press the <ENTER> button while displaying the image in full screen to return to the screen in thumbnail view. Select different image by pressing ▲▼◀▶ to switch the image to display.
- When the <AUTO SETUP/CANCEL> button on the remote control or the <LENS/CANCEL> button on the control panel is pressed while displaying the image from the device, the information such as the network ID, the projector name, or the QR code is displayed on the screen. For details of these information, refer to "Description of the standby screen" (➡ page 179).
- When "Wireless Manager ME6.4" or "Wireless Projector" is used, selection of the image to display in full screen can be operated from the web browser. For details, refer to the Operation Instructions of each application software.
- When the [NETWORK/USB] menu → [WIRELESS LAN] is set to [SIMPLE] or [M-DIRECT], the number of devices that can connect to the projector via wireless LAN is restricted to 10 devices.

# Projecting with MIRRORING input

By using the mirroring function, the screen of the Miracast compatible device can be displayed as a projected image.

- To use the mirroring function, it is necessary to attach the optional Wireless Module (Model No.: ET-WM300). For details on how to attach the optional Wireless Module (Model No.: ET-WM300), refer to “Attaching the Wireless Module” (➔ page 50).

## Connecting the device

### 1) Press the <NETWORK/USB> button to switch the input to MIRRORING.

- Every time the <NETWORK/USB> button is pressed, the input will switch in the order of MEMORY VIEWER, Panasonic APPLICATION, and MIRRORING. Press the <NETWORK/USB> button until the input switches to MIRRORING.
- The standby screen is displayed once the input is switched to MIRRORING.

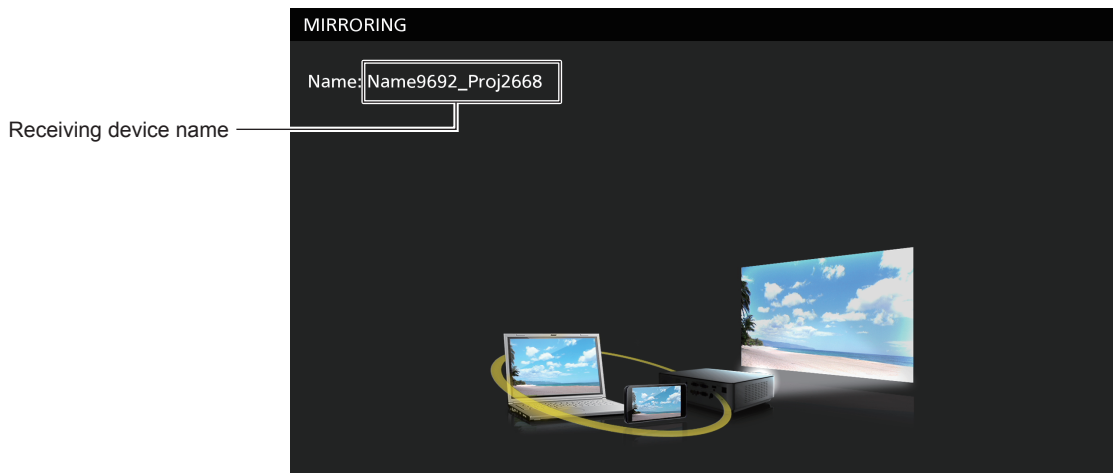

### 2) Search the display device that can be connected on the Miracast compatible device, and select this projector and connect it.

- Confirm the receiving device name displayed in the standby screen, and select the device name corresponding to this projector from the search result displayed in the device screen.
- When the [NETWORK/USB] menu → [MIRRORING] → [CONNECTION TYPE] is set to [PIN], entry of PIN may be requested at the time of connection. In such case, enter the eight-digit PIN code displayed at the top of the standby screen.
- After a while, the screen of the device is displayed as a projected image.

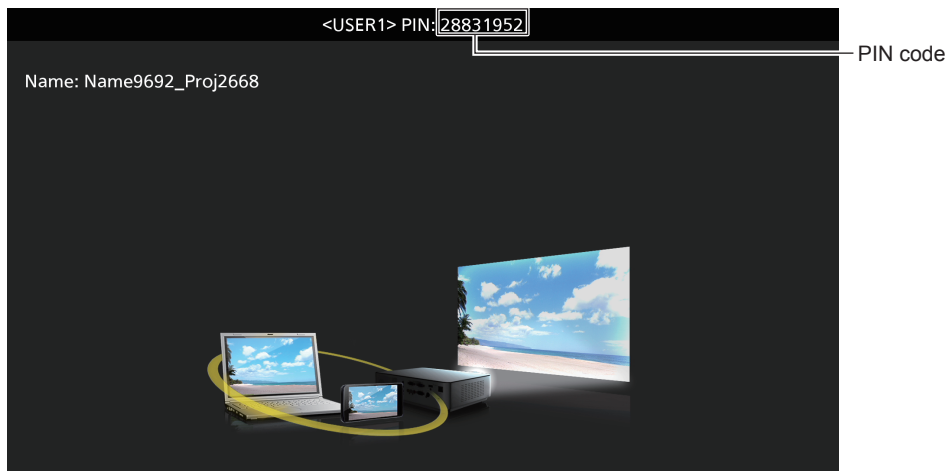

## Note

- The operation method may differ depending on the device or the application software in use.
- For details of connection by the mirroring function, refer to the [NETWORK/USB] menu → [MIRRORING] (➔ page 149).
- The mirroring function cannot be used when the [NETWORK/USB] menu → [WIRELESS LAN] is set to [DISABLE].
- The receiving device name displayed in the standby screen is constructed by the projector name set to the projector and the network ID unique to the projector.

- Press the <AUTO SETUP/CANCEL> button while displaying the device screen to display the receiving device name at the top left of the screen.

## Ending the connection with the device

### 1) Perform disconnection process in the device side.

- Once the connection is disconnected, the standby screen is displayed.

#### Note

- It may take some time for the standby screen to display when the connection is ended forcefully by turning off the device, etc., without performing an appropriate disconnection process.

## Using the moderator mode in the MIRRORING input

When using the projector in the moderator mode, the moderator can specify the device allowed to display by operating the projector when multiple devices are connected to the projector for mirroring.

### 1) Set the [NETWORK/USB] menu → [MIRRORING] → [MODERATOR MODE] to [ON].

### 2) Press the <NETWORK/USB> button to switch the input to MIRRORING.

- Every time the <NETWORK/USB> button is pressed, the input will switch in the order of MEMORY VIEWER, Panasonic APPLICATION, and MIRRORING. Press the <NETWORK/USB> button until the input switches to MIRRORING.
- The standby screen is displayed once the input is switched to MIRRORING.

### 3) Search the display that can be connected on the Miracast compatible device, and select this projector.

- Confirm the receiving device name displayed in the standby screen, and select the device name corresponding to this projector from the search result displayed in the device screen.
- When the [NETWORK/USB] menu → [MIRRORING] → [CONNECTION TYPE] is set to [PIN], entry of PIN may be requested at the time of connection. In such case, enter the eight-digit PIN code displayed at the top of the standby screen.

### 4) Press ▲▼ to select the device to allow connection, and press the <ENTER> button.

- Select the device to display its screen from the device names displayed in the standby screen.
- After a while, the screen of the selected device is displayed as a projected image.

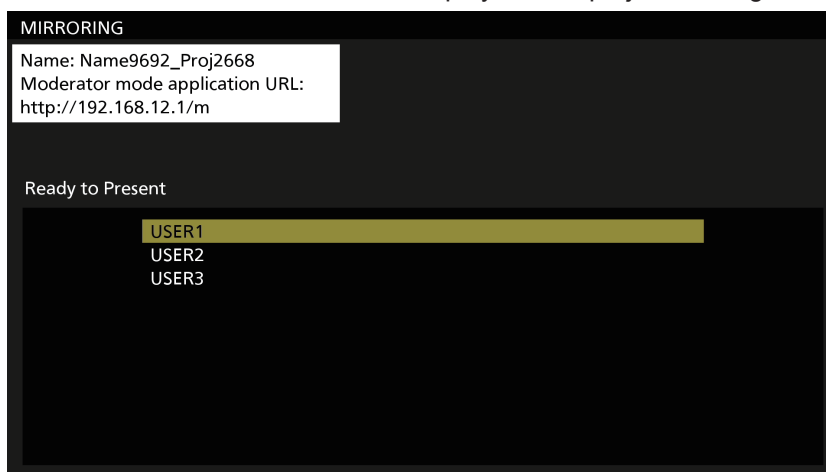

#### Note

- The operation method may differ depending on the device or the application software in use.
- For details on moderator mode setting, refer to the [NETWORK/USB] menu → [MIRRORING] (➡ page 149).
- The device name displayed in the standby screen differs depending on the device and the application software that is used. In case of the Miracast compatible Windows computer, the computer name is displayed.
- Press either ▲▼ or the <ENTER> button while displaying the screen of the device to display the standby screen.
- Selection of the device to display can also be performed on the web browser. For details, refer to "Operating with the web browser" (➡ page 183).
- Press the <AUTO SETUP/CANCEL> button while displaying the device screen to display the receiving device name at the top left of the screen.

## Operating with the web browser

When using the projector in the moderator mode, the device to be allow connection can be specified with the web browser in addition to operation in the standby screen.

- 1) Set the [NETWORK/USB] menu → [MIRRORING] → [MODERATOR MODE] to [ON].
- 2) Press the <NETWORK/USB> button to switch the input to MIRRORING.
  - Every time the <NETWORK/USB> button is pressed, the input will switch in the order of MEMORY VIEWER, Panasonic APPLICATION, and MIRRORING. Press the <NETWORK/USB> button until the input switches to MIRRORING.
  - The standby screen is displayed once the input is switched to MIRRORING.
- 3) Search the display that can be connected to the Miracast compatible device, and select this projector.
  - Confirm the receiving device name displayed in the standby screen, and select the device name corresponding to this projector from the search result displayed in the device screen.
  - When the [NETWORK/USB] menu → [MIRRORING] → [CONNECTION TYPE] is set to [PIN], entry of PIN may be requested at the time of connection. In such case, enter the eight-digit PIN code displayed at the top of the standby screen.
- 4) Press the <AUTO SETUP/CANCEL> button.
  - The receiving device name and the URL to access the projector is displayed at the top left of the screen.
- 5) Start the web browser in the moderator device.
  - Perform the operation in Step 3) in advance on the moderator device.
  - For the browser that can be used, refer to “Computer that can be used for setting” (➔ page 158).
- 6) Enter the address displayed in Step 4) into the URL entry field of the web browser.
- 7) Enter the user name and password with moderator rights.
  - The factory default setting of the user name is moderator, and the password is @Panasonic.
- 8) Click OK.
  - The [MODERATOR MODE] page is displayed.

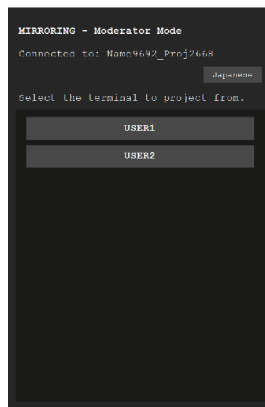

- 9) Click the device to allow connection.
  - Select the device to display the screen with the projector from the names of devices displayed in the [MODERATOR MODE] page.
  - After a while, the screen of the selected device is displayed as a projected image.

### Note

- Click another device in the [MODERATOR MODE] page while projecting the screen of the device and switch the display to the screen of that device. Clicking the device being projected will end the projection of the device, and display the standby screen.
- The [MODERATOR MODE] page can be operated with the user name and password with the administrator rights for the web control screen.

## Description of the [MODERATOR MODE] page

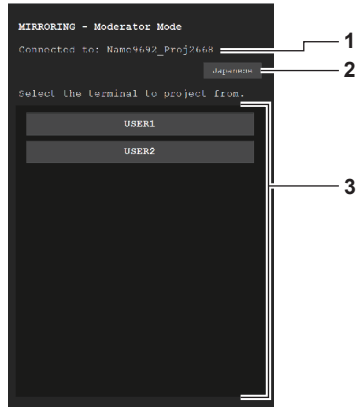

**1 Connection destination**

Displays the receiving device name that is connected.

**2 Language switching button**

Switches the display language (Japanese/English).

**3 Device list**

Click the device name to display the screen of that device as a projected image.

### Note

- The user name and password with moderator rights can be changed in the “[Change password] page” (➡ page 174) of the web control screen.



# Projecting with MEMORY VIEWER input

Display the still image or movie recorded in the USB memory as a projected image using the Memory Viewer function.

## Images that can be played back with the Memory Viewer function

The following still image/movie files can be played back on the projector.

Still image	Extension	Format	Restriction
	jpg/jpeg	JPEG	Number of pixels: Maximum 8 000 x 8 000 (For progressive format, maximum 4 096 x 4 096) YUV format: Only YUV444, YUV422, and YUV411 supported Color mode: Only RGB supported
bmp	Windows Bitmap	Number of pixels: Maximum 2 000 x 2 000 (1 bit, 4 bits, 8 bits, 16 bits, 24 bits, 32 bits supported) Following formats are not supported. Run-length encoding, Bit fields, Top to bottom, Transparent data	

Movie	Extension	Codec		Restriction*1	
		Video	Audio	Video	Audio
mov	H.264/MPEG-4 AVC Motion JPEG	AAC Linear PCM	Resolution: Maximum 1 920 x 1 080 Minimum 240 x 180 Frame rate: Maximum 30 fps Bit rate: Maximum 40 Mbps	Sample rate: Maximum 48 kHz (For Linear PCM, maximum 16 kHz) Channel: Maximum 2 ch Bit rate: Maximum 384 kbps	
avi	H.264/MPEG-4 AVC Motion JPEG MPEG-4	MPEG-1/2 Audio Layer-3 (MP3) AAC Linear PCM			
mp4	H.264/MPEG-4 AVC MPEG-4	AAC MPEG-4 AAC-LC			
mpg/mpeg	MPEG-2	MPEG-1/2 Audio Layer-2			
wmv	WMV9	WMA			

\*1 Following movie files are not supported.

- Files with the video codec of WMV7, WMV8, DivX, or Xvid
- Uncompressed video
- Multi-angle video
- Files with the profile of Advanced Simple Profile @ Level 0 or Advanced Simple Profile @ Level 1

### Note

- Some information for still image/movie files can be viewed with a computer where relevant files are accessible.

#### Operation example

##### – For Windows computer

1. Right-click a file, and click [Properties].
2. Click the [Details] tab.

##### – For Mac

1. Click a file while holding down the “Control” key, and click [Get Info].
2. Click [More Info].

- File size that can be played back is 2 GB at the maximum.
- Files protected by DRM (Digital Rights Management) cannot be played back.
- The total number of folders/files that can be recognized on the projector is 1 000 at the maximum. If there are 1 001 or more folders/files, an error message is displayed.
- Some files cannot be played back even if the formats are supported.
- For USB memory that can be used with the projector, refer to “USB memory that can be used with the projector” (➔ page 69).

## Displaying the Memory Viewer screen

When the [NETWORK/USB] menu → [MEMORY VIEWER] → [AUTOPLAY] is set to [ON] or [OFF], the still image or movie file can be selected and played back in the Memory Viewer screen.

When [AUTOPLAY] is set to [SCENARIO], the Memory Viewer screen is not displayed, and projection of still image or movie and transmission of the Light ID signal are performed automatically following the setting of the scenario file.

For operation of [SCENARIO], refer to “Playing back using the contents list” (➔ page 192).

- 1) **Connect the USB memory with still image or movie file recorded to the <VIEWER/PAIRING> terminal.**
  - For the handling of the USB memory, refer to “Using the USB memory” (➔ page 69).
- 2) **Press the <NETWORK/USB> button to switch the input to MEMORY VIEWER.**
  - Every time the <NETWORK/USB> button is pressed, the input will switch in the order of MEMORY VIEWER, Panasonic APPLICATION, and MIRRORING. Press the <NETWORK/USB> button until the input switches to MEMORY VIEWER.
  - The Memory Viewer screen (thumbnail or list view) is displayed.
  - The cursor is at the thumbnail display area or the list display area at the right of the screen. (Cursor background color: yellow)



Example of displaying in thumbnail view

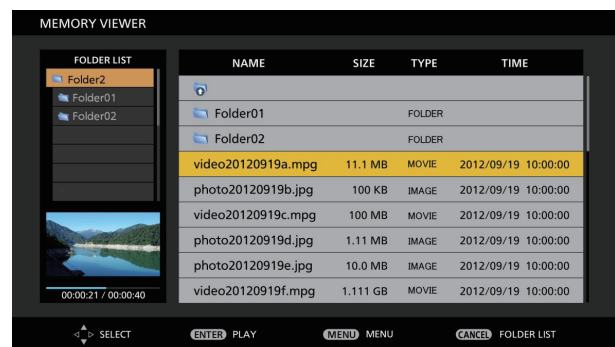

Example of displaying in list view

### Note

- Display method (displaying in thumbnail view or list view) in the Memory Viewer screen can be set in the [NETWORK/USB] menu → [MEMORY VIEWER] → [VIEW] (➔ page 146).

## Operating the Memory Viewer screen

This section describes an example of screen operations after the Memory Viewer screen is displayed.

### For thumbnail view



- 1) **Press ▲▼◀▶ to select a file.**
  - Select a folder in the thumbnail display area and press the <ENTER> button to display the files inside that folder.

- Press the <AUTO SETUP/CANCEL> button to move the cursor from the thumbnail display area at the right of the screen to the folder list at the left of the screen. Press ▲▼ to select a folder and press the <ENTER> button to display the files inside that folder in the thumbnail display area, and move the cursor to the thumbnail display area.
- The information of the selected still image or movie file is displayed in the information area at the bottom left of the screen.

**2) Press the <ENTER> button.**

- Playback starts in the full-screen display.
- For details on playback procedure, refer to “Playing back still images” (➡ page 188) or “Playing back movies” (➡ page 189).

**3) Press the <AUTO SETUP/CANCEL> button to end playback.**

- Full-screen display ends and the Memory Viewer screen (thumbnail view) is displayed.
- To subsequently play back another file, perform Steps 1) to 2).

**Note**

- Every time the <AUTO SETUP/CANCEL> button is pressed while displaying the Memory Viewer screen, the cursor will move between the folder list and the thumbnail display areas.
- The display order of the thumbnail follows the setting in the [NETWORK/USB] menu → [MEMORY VIEWER] → [SORT] (➡ page 146).

**For list view**

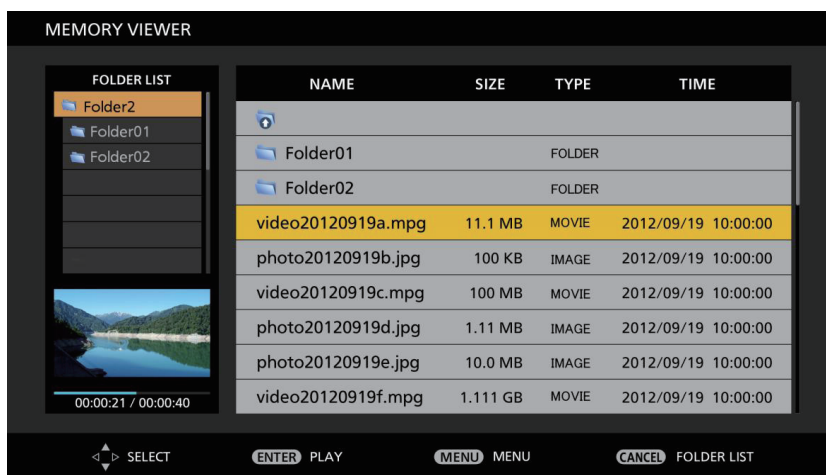

**1) Press ▲▼ to select a file.**

- Select a folder in the list display area and press the <ENTER> button to display the files inside that folder.
- Press the <AUTO SETUP/CANCEL> button to move the cursor from the list display area at the right of the screen to the folder list at the left of the screen. Press ▲▼ to select a folder and press the <ENTER> button to display the files inside that folder in the list display area, and move the cursor to the list display area.
- The thumbnail of the selected still image or movie file is displayed in the area on the lower left of the screen.

**2) Press the <ENTER> button.**

- Playback starts in the full-screen display.
- For details on playback procedure, refer to “Playing back still images” (➡ page 188) or “Playing back movies” (➡ page 189).

**3) Press the <AUTO SETUP/CANCEL> button to end playback.**

- Full-screen display ends and the Memory Viewer screen (list view) is displayed.
- To subsequently play back another file, perform Steps 1) to 2).

**Note**

- Every time the <AUTO SETUP/CANCEL> button is pressed while displaying the Memory Viewer screen, the cursor will move between the folder list and the list display areas.
- The display order of the list follows the setting in the [NETWORK/USB] menu → [MEMORY VIEWER] → [SORT] (➡ page 146).

## Playing back still images

This section describes the procedure using an operation example on the Memory Viewer screen in thumbnail view.

Playback on the Memory Viewer screen in list view can be performed with the same procedure except for the file selection.

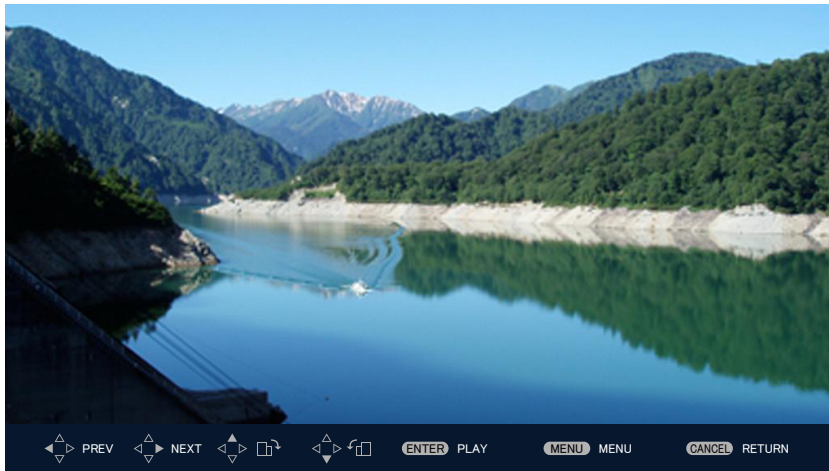

Example of display during automatic playback (still image)

### When automatic playback is enabled

This section describes the operation method when the [NETWORK/USB] menu → [MEMORY VIEWER] → [AUTOPLAY] (➡ page 146) is set to [ON].

In this case, all the still image files inside a single folder is automatically played back following the setting in the [NETWORK/USB] menu → [MEMORY VIEWER] (➡ page 145) → [INTERVAL] and [EFFECT].

**1) Press ▲▼◀▶ to select the file to project first from the thumbnail, and press the <ENTER> button.**

- Playback starts in the full-screen display.
- Press the <ENTER> button during playback to pause automatic playback. Press it again to resume playback.
- After playback ends, playback of the next file starts.
- Press ▶ during playback to continue the automatic playback from the next image after skipping the file currently playing back.
- Press ◀ during playback to continue the automatic playback after returning back to the previous file.
- Press ▲ during playback to rotate the image 90° clockwise while retaining the aspect ratio.
- Press ▼ during playback to rotate the image 90° counterclockwise while retaining the aspect ratio.

**2) Press the <AUTO SETUP/CANCEL> button.**

- Automatic playback ends and the Memory Viewer screen (thumbnail view) returns.

### When automatic playback is disabled

This section describes the operation method when the [NETWORK/USB] menu → [MEMORY VIEWER] → [AUTOPLAY] (➡ page 146) is set to [OFF]. In this case, files to be projected are selected and played back one by one.

**1) Press ▲▼◀▶ to select a file from the thumbnail, and press the <ENTER> button.**

- The selected still image is played back in the full-screen display.
- Press ▶ to playback the next file.
- Press ◀ to playback the previous file.
- Press ▲ to rotate the image 90° clockwise while retaining the aspect ratio.
- Press ▼ to rotate the image 90° counterclockwise while retaining the aspect ratio.

**2) Press the <AUTO SETUP/CANCEL> button.**

- Full-screen display ends and the Memory Viewer screen in thumbnail view returns.

**Note**

- When the recorded number of pixels is smaller than the maximum number of display dot\*1, it will be displayed enlarged maintaining the aspect ratio.
  - When the recorded number of pixels is larger than the maximum number of display dot\*1, it will be displayed reduced maintaining the aspect ratio.
  - Order of the playback follows the display order set in the [NETWORK/USB] menu → [MEMORY VIEWER] → [SORT] (➡ page 146). Also in the cases where still image and movie files both exist in the same folder, they are played back according to the [SORT] setting.
  - The operating guide at the bottom of the playback screen can be erased by setting the [NETWORK/USB] menu → [MEMORY VIEWER] → [GUIDE] (➡ page 146) to [OFF].
  - Playback ends and the Memory Viewer screen returns when the contents list is distributed using the “Multi Monitoring & Control Software” during playback. To resume the playback of still images, perform the playback operation after the distribution of contents list is completed.
- \*1 The maximum number of display dot for each product is as follows.  
 PT-MZ670, PT-MZ570: 1 920 x 1 080  
 PT-MW630, PT-MW530: 1 280 x 800

**Playing back movies**

This section describes the procedure using an operation example on the Memory Viewer screen in thumbnail view.

Playback on the Memory Viewer screen in list view can be performed with the same procedure except for the file selection.

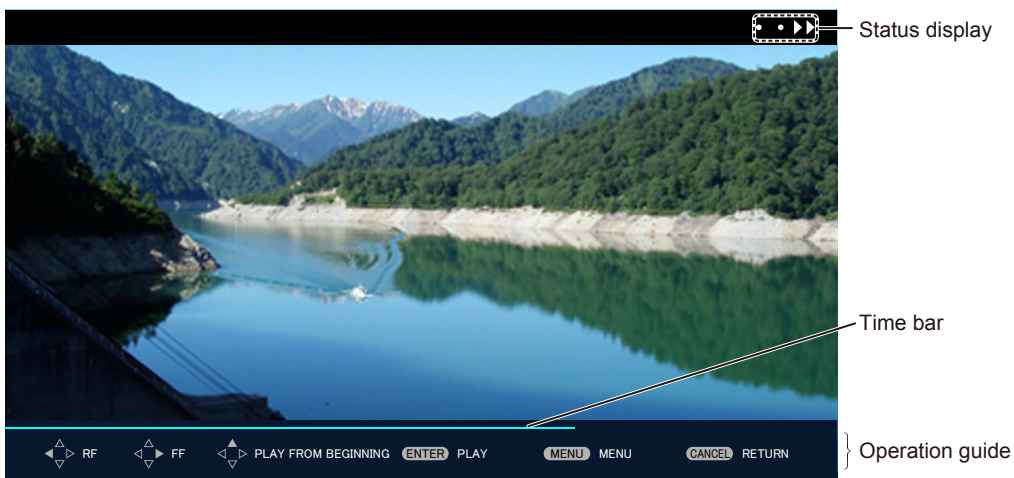

Example of display during fast-forward playback (x10 speed)

**When automatic playback is enabled**

This section describes the operation method when the [NETWORK/USB] menu → [MEMORY VIEWER] → [AUTOPLAY] (➡ page 146) is set to [ON].

In this case, all movie files in the same folder are played back automatically.

- 1) **Press ▲▼◀▶ to select the file to project first from the thumbnail, and press the <ENTER> button.**
  - Playback starts in the full-screen display.
  - Press the <ENTER> button during playback to pause playback. Press it again to resume playback from the position where the playback has been stopped.
  - After playback ends, playback of the next file starts.
  - Press ▶ during playback to perform the fast-forward playback. The speed is increased every time ▶ is pressed. (3 levels)
  - Press ◀ during playback to perform the rewind playback. The speed is increased every time ◀ is pressed. (3 levels)
  - Press ▲ during playback to play back the file being played back from the start. (cue)
  - Press ▶ while paused to play back the next file skipping the file being played back.
  - Press ◀ while paused to go back and play back the previous file.
- 2) **Press the <AUTO SETUP/CANCEL> button.**
  - Automatic playback ends and the Memory Viewer screen (thumbnail view) returns.

## When automatic playback is disabled

This section describes the operation method when the [NETWORK/USB] menu → [MEMORY VIEWER] → [AUTOPLAY] (➡ page 146) is set to [OFF].

In this case, files to be projected are selected and played back one by one.

### 1) Press ▲▼◀▶ to select a file from the thumbnail, and press the <ENTER> button.

- Playback starts in the full-screen display.
- Press the <ENTER> button during playback to pause playback. Press it again to resume playback from the position where the playback has been stopped.
- After playback ends, playback goes into pause state at the beginning of the file.
- Press ▶ during playback to perform the fast-forward playback. The speed is increased every time ▶ is pressed. (3 levels)
- Press ◀ during playback to perform the rewind playback. The speed is increased every time ◀ is pressed. (3 levels)
- Press ▲ during playback to play back the file being played back from the start. (cue)
- Press ▶ while paused to play back the next file skipping the file being played back.
- Press ◀ while paused to go back and play back the previous file.

### 2) Press the <AUTO SETUP/CANCEL> button.

- Full-screen display ends and the Memory Viewer screen in thumbnail view returns.

## Note

- When the recorded number of pixels is smaller than the maximum number of display dot\*1, it will be displayed enlarged maintaining the aspect ratio.
- When the recorded number of pixels is larger than the maximum number of display dot\*1, it will be displayed reduced maintaining the aspect ratio.
- Order of the playback follows the display order set in the [NETWORK/USB] menu → [MEMORY VIEWER] → [SORT] (➡ page 146). Also in the cases where still image and movie files both exist in the same folder, they are played back according to the [SORT] setting.
- The time bar in the operating guide at the bottom of the playback screen can be erased by setting the [NETWORK/USB] menu → [MEMORY VIEWER] → [GUIDE] (➡ page 146) to [OFF].
- Playback ends and the Memory Viewer screen returns when the contents list is distributed using the "Multi Monitoring & Control Software" during playback. To resume the playback of movies, perform the playback operation after the distribution of contents list is completed.

\*1 The maximum number of display dot for each product is as follows.

PT-MZ670, PT-MZ570: 1 920 x 1 080  
PT-MW630, PT-MW530: 1 280 x 800

## Resume playback

When the automatic playback is disabled (the [NETWORK/USB] menu → [MEMORY VIEWER] → [AUTOPLAY] (➡ page 146) is set to [OFF]), resume playback can be performed.

Resume playback is a function that stops movie playback in the middle and restarts playback from the position where the movie has been stopped the last time when the same file is to be played back next time.

The following operations resume playback from the position where the last playback has been stopped.















- Stopping movie playback in the middle, going back to the Memory Viewer screen, and then selecting the same movie file again and playing it back
- After playing back other movie or still image files, selecting the previous movie file and playing it back

## Note

- Resume information (information on the position when movie playback is stopped in the middle) is automatically saved at the time when playback is paused by pressing the <ENTER> button during playback or when full-screen display is ended by pressing the <AUTO SETUP/CANCEL> button during playback.
- Resume information (information on the position when movie playback is stopped in the middle) of 50 movie files can be saved. After the 51st movie file is played back, resume information will be deleted in order from the oldest.
- When resume playback is performed, some files may not be played back from the correct position where the last playback has been stopped.
- All resume information is discarded when following operation is performed.
  - Removing the USB memory
  - Disconnecting the power cord

## Description of the Memory Viewer screen

The icons on the Memory Viewer screen indicate the following.

	An icon to indicate moving to upper hierarchy. Select it to move to the upper hierarchy.
	An icon to display folders in lower hierarchy. Select it to move to the lower hierarchy.
	An icon to indicate that the file is still image.
	An icon to indicate that the file is movie.
	An icon to indicate that the extension of the file is supported but it cannot be opened.
	Rotates the still image 90° counterclockwise.
	Rotates the still image 90° clockwise.
	Indicates that fast-forward playback is being performed in approximately x2 speed. (with audio)
	Indicates that fast-forward playback is being performed in approximately x5 speed.
	Indicates that fast-forward playback is being performed in approximately x10 speed.
	Indicates that playback is being paused.
	Indicates that fast-rewind playback is being performed in approximately x2 speed.
	Indicates that fast-rewind playback is being performed in approximately x5 speed.
	Indicates that fast-rewind playback is being performed in approximately x10 speed.

## Playing back using the contents list

When the [NETWORK/USB] menu → [MEMORY VIEWER] → [AUTOPLAY] is set to [SCENARIO], playback of still image or movie and transmission of the Light ID signal are performed automatically following the setting of the contents list saved in the USB memory. To transmit the Light ID signal, it is necessary to set the [PROJECTOR SETUP] menu → [LightID] to [EXTERNAL CONTROL].

The contents list is generated with the “Multi Monitoring & Control Software”, and it can be saved in the USB memory, etc. For details, refer to the Operating Instructions of “Multi Monitoring & Control Software”.

- 1) **Insert the USB memory with the contents list saved into the <VIEWER/PAIRING> terminal.**
  - For the handling of the USB memory, refer to “Using the USB memory” (➔ page 69).
- 2) **Press the <NETWORK/USB> button to switch the input to MEMORY VIEWER.**
  - Every time the <NETWORK/USB> button is pressed, the input will switch in the order of MEMORY VIEWER, Panasonic APPLICATION, and MIRRORING. Press the <NETWORK/USB> button until the input switches to MEMORY VIEWER.
  - Once the input is switched to MEMORY VIEWER, playback is repeated automatically following the setting of the contents list.
- 3) **Press the <NETWORK/USB> button to switch the input to anything other than MEMORY VIEWER to end.**
  - Once the input is switched to anything other than MEMORY VIEWER, playback using the contents list ends.

### Note

- The contents list is the following 4 types of file. Generate it in advance using the “Multi Monitoring & Control Software”.
  - Scenario file specifying the playback order and time (scenario.dat)
  - File list summarizing the playback file names (filelist.dat)
  - Light ID definition file to specify the Light ID (lightid.dat)
  - Contents file to project movies and still images (jpg, mp4 etc.)
- Nothing is played back, when the [NETWORK/USB] menu → [MEMORY VIEWER] → [AUTOPLAY] is set to [SCENARIO] and there is no contents list in the USB memory, or there is defect in it.
- Playback can also be stopped by setting the [NETWORK/USB] menu → [MEMORY VIEWER] → [AUTOPLAY] to anything other than [SCENARIO].
- Playback is suspended and the contents list is updated when the contents list is distributed using the “Multi Monitoring & Control Software” during playback using the contents list. Once the update of contents list is completed, playback using the overwritten contents list resumes.



## Using the pairing function

When the following two conditions are met, the guide for writing the pairing data is displayed in the standby screen when the USB memory is connected to the <VIEWER/PAIRING> terminal.

- The [NETWORK/USB] menu → [Panasonic APPLICATION] → [PAIRING GUIDE] is set to [ON]
- Input is Panasonic APPLICATION

By writing the pairing data to the USB memory following the instruction, the pairing of the projector and that USB memory is completed.

Connection to the projector is automatically performed by attaching the USB memory paired with the projector to the USB terminal of the Windows computer or Mac, and starting the image transfer application software “Plug and Share” in the USB memory.

The pairing data is a connection information between the image transfer application software “Plug and Share”, and the projector and the USB memory.

### Attention

- Do not use a USB extension cable or a USB hub, and directly insert the USB memory into the <VIEWER/PAIRING> terminal of the projector.
- Do not insert the USB memory into the <DC OUT> terminal. The USB memory cannot be used on the <DC OUT> terminal.

### Note

- If the USB memory cannot be directly connected to the <VIEWER/PAIRING> terminal of the projector, such as the projector is installed on the ceiling, it is possible to download the image transfer application software “Plug and Share” to a USB memory from the Panasonic website, and use it. Refer to the following URL.  
<https://panasonic.net/cns/projector/>

## Pairing the USB memory

- 1) Set the [NETWORK/USB] menu → [Panasonic APPLICATION] → [PAIRING GUIDE] to [ON].
- 2) Press the <NETWORK/USB> button to switch the input to Panasonic APPLICATION.
  - Every time the <NETWORK/USB> button is pressed, the input will switch in the order of MEMORY VIEWER, Panasonic APPLICATION, and MIRRORING. Press the <NETWORK/USB> button until the input switches to Panasonic APPLICATION.
  - The standby screen is displayed once the input is switched to Panasonic APPLICATION.
- 3) Connect the USB memory for pairing to the <VIEWER/PAIRING> terminal.
  - For the USB memory that can be used for pairing, refer to “USB memory that can be used with the projector” (➔ page 69).
  - For the handling of the USB memory, refer to “Using the USB memory” (➔ page 69).
- 4) When the confirmation message is displayed on the standby screen, press ◀▶ to select [OK], and press the <ENTER> button.
  - The pairing data is written to the USB memory.

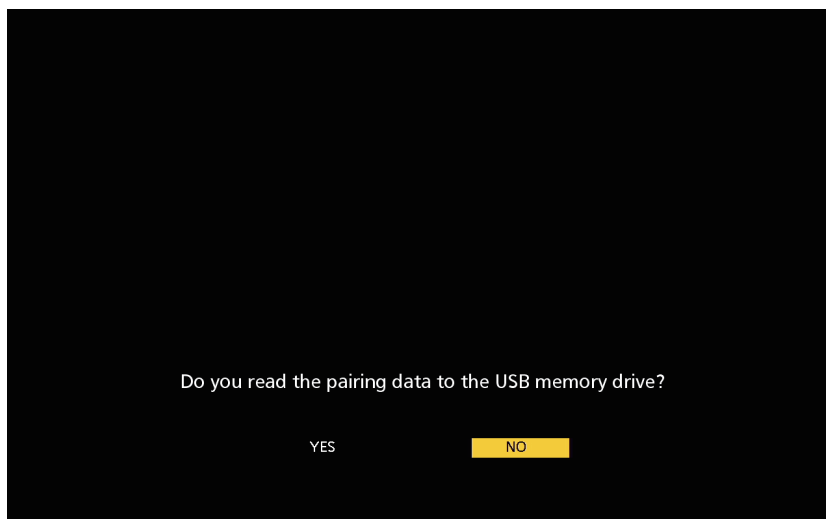

- 5) Once the completion message is displayed in the standby screen, remove the USB memory.

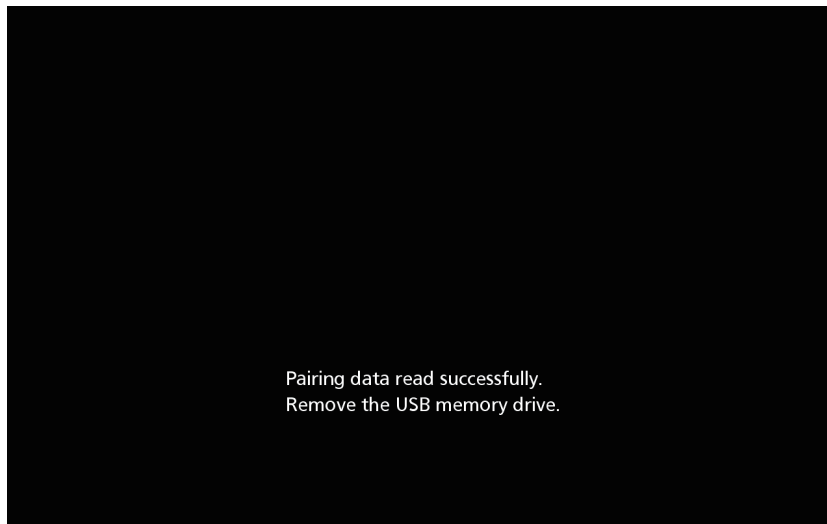

---

**Note**

- Use the commercially available USB memory formatted in FAT16 or FAT32 as the USB memory to be used for pairing. Approximately 30 MB of available space is required.
- Displaying of the image using the image transfer application software is not possible during pairing. Also, the pairing function cannot be used while displaying the image using the image transfer application software.
- For how to use the image transfer application software "Plug and Share", refer to the Operating Instructions of "Plug and Share". Operating Instructions of "Plug and Share" can be downloaded from the Panasonic website (<https://panasonic.net/cns/projector/>).

# Chapter 6 Maintenance

---

This chapter describes methods of inspection when there are problems, maintenance, and replacement of the units.

# Light source/temperature/filter indicators

## When an indicator lights up

If a problem occurs inside the projector, the light source indicator <LIGHT>/temperature indicator <TEMP>/filter indicator <FILTER> will inform you by illuminating or blinking. Check the status of the indicators and take following measures.

### Attention

- When switching off the projector to deal with problems, make sure to follow the procedure in “Switching off the projector” (➔ page 65).

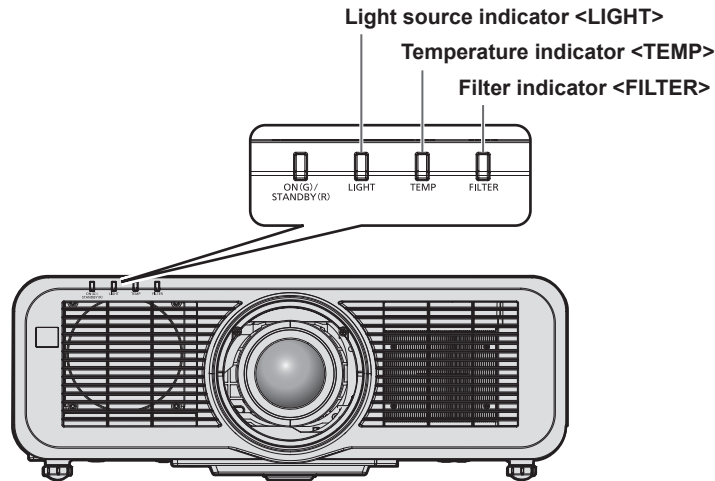

## Light source indicator <LIGHT>

Indicator status	Lighting in red	Blinking in red (2 times)	Blinking in red (3 times)
<b>Status</b>	Some of the elements of the light source are defective and the light output has decreased.	The light source does not light up, or the light source turns off while the projector is in use.	
<b>Solution</b>	<ul style="list-style-type: none"> <li>Turn the &lt;MAIN POWER&gt; switch to &lt;OFF&gt; (➔ page 65), and turn on the power again.</li> </ul>		

### Note

- If the light source indicator <LIGHT> continues to light or blink even after the measure is taken, set the <MAIN POWER> switch to <OFF>, and ask your dealer for repair.
- When the projector is in projecting state and there is no notification by illuminating or blinking in red, the light source indicator <LIGHT> is turned off.

**Temperature indicator <TEMP>**

Indicator status	Lighting in red	Blinking in red (2 times)	Blinking in red (3 times)
<b>Status</b>	Internal temperature is high (warning).	Internal temperature is high (standby status).	The cooling fan has stopped.
<b>Cause</b>	<ul style="list-style-type: none"> <li>Is the air intake/exhaust port blocked?</li> <li>Is the room temperature high?</li> </ul>		—
<b>Solution</b>	<ul style="list-style-type: none"> <li>Remove any objects that are blocking the air intake/exhaust port.</li> <li>Install the projector in a location with the operating environment temperature between 0 °C (32 °F) and 45 °C (113 °F).</li> <li>Do not use the projector at high altitudes of 2 700 m (8 858') or higher above sea level.</li> </ul>		<ul style="list-style-type: none"> <li>Turn the &lt;MAIN POWER&gt; switch to &lt;OFF&gt; (➔ page 65), and consult your dealer.</li> </ul>

**Note**

- If the temperature indicator <TEMP> is still lit or blinking after taking the measures, ask your dealer for repair.

**Filter indicator <FILTER>**

Indicator status	Lighting in red		Blinking in red
<b>Status</b>	The filter is clogged. The ambient or internal temperature is abnormally high.		Air filter unit is not attached.
<b>Cause</b>	<ul style="list-style-type: none"> <li>Is the air filter unit dirty?</li> </ul>	<ul style="list-style-type: none"> <li>Is the air intake/exhaust port blocked?</li> </ul>	<ul style="list-style-type: none"> <li>Is the air filter unit attached?</li> </ul>
<b>Solution</b>	<ul style="list-style-type: none"> <li>Clean or replace the air filter unit. (➔ page 198)</li> </ul>	<ul style="list-style-type: none"> <li>Remove any objects that are blocking the air intake/exhaust port.</li> </ul>	<ul style="list-style-type: none"> <li>Attach the air filter unit.</li> </ul>

**Note**

- If the filter indicator <FILTER> is still lit or blinking after taking the measures, ask your dealer for repair.
- If the air filter unit is not attached when the projector is turned on, the filter indicator <FILTER> will blink in red.
- When clogging of the filter is detected and the brightness of the light source is restricted, the [PROJECTOR SETUP] menu → [LightID] (➔ page 115) will be set [OFF], and the Light ID signal will not be transmitted. Set it again after clearing the clogging.

# Maintenance/replacement

## Before performing maintenance/replacement

- Make sure to turn off the projector and disconnect the power plug from the outlet before maintaining or replacing the unit. (➔ pages 57, 65)
- When switching off the projector, make sure to follow the procedures in “Switching off the projector” (➔ page 65).

## Maintenance

### Outer case

Wipe off dirt and dust with a soft, dry cloth.

- If the dirt is persistent, soak the cloth with water and wring it thoroughly before wiping. Dry off the projector with a dry cloth.
- Do not use benzene, thinner, or rubbing alcohol, other solvents, or household cleaners. Doing so may deteriorate the outer case.
- When using chemically treated dust cloths, follow the instructions written on its packaging.

### Lens front surface

Wipe off dirt and dust from the front surface of the lens with a soft clean cloth.

- Do not use a cloth that is fluffy, dusty, or soaked with oil/water.
- Since the lens is fragile, do not use excessive force when wiping the lens.

### Attention

- The lens is made of glass. Impacts or excessive force when wiping may scratch its surface. Handle with care.

### Air filter unit

Perform maintenance of the air filter unit in the following case.

- The air filter is clogged with dust, causing the filter replacement message to appear on the screen and the filter indicator <FILTER> to light in red.

### Attention

- Make sure to secure the stability of the projector, and perform the maintenance in a safe location even if the air filter cover or the air filter unit falls accidentally.
- When the air filter unit is replaced, reset the filter counter.  
If the filter counter is not reset after replacing the air filter unit, [FILTER COUNTER has reached the set time.] is displayed.  
For details of resetting the filter counter, refer to “Resetting the filter counter” (➔ page 200).

### Removing the air filter unit

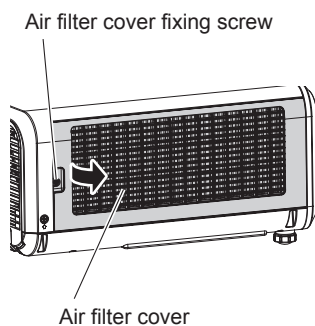

Fig. 1

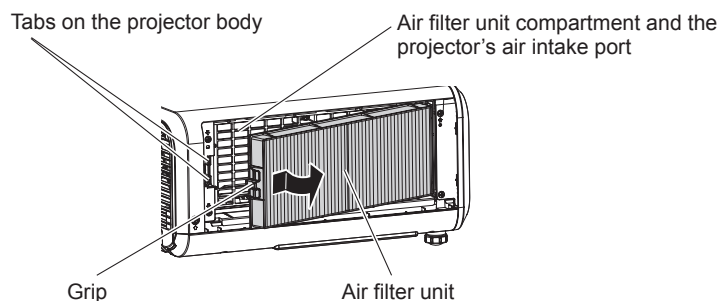

Fig. 2

#### 1) Turn off the power of the projector.

- Always follow the procedure of “Switching off the projector” (➔ page 65) when turning off the power.

**2) Remove the air filter cover. (Fig. 1)**

- Turn the air filter cover fixing screw (x 1) counterclockwise with a Phillips screwdriver until it turns freely, and remove the air filter cover by placing a finger in the depressed section and pull it out slowly in the direction of the arrow.
- When pulling out the air filter cover, make sure to place a hand on the air filter cover. Pulling it out too rapidly may cause the air filter cover to fall.

**3) Pull out the air filter unit. (Fig. 2)**

- Slightly push the grip of the air filter unit inward in the direction of the arrow, remove from the tabs on the projector body, and pull out the air filter unit.
- After pulling out the air filter unit, remove any foreign object and dust from the air filter unit compartment and the projector's air intake port.

---

**Performing maintenance of the air filter unit**

---

Remove the air filter unit in advance with the procedure for "Removing the air filter unit" (➡ page 198) described previously.

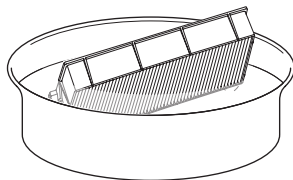

Fig. 1

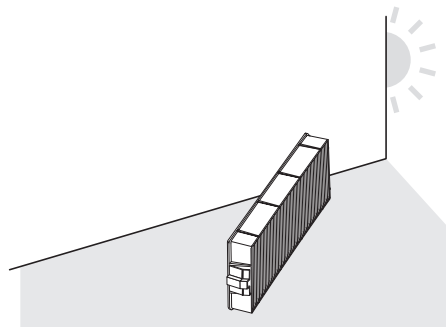

Fig. 2

**1) Wash the air filter unit. (Fig. 1)**

- i) Soak the air filter unit in cold or warm water and then lightly rinse it.
  - Do not use cleaning tools such as brushes.
  - When rinsing, hold the frame of the air filter unit without putting strong pressure on the filter unit.
- ii) Rinse the air filter unit two to three times using fresh water each time.
  - Insufficient rinsing may result in odors.

**2) Dry the air filter unit. (Fig. 2)**

- Let the air filter unit naturally dry off in a well-ventilated place where there is little dust and is not exposed to direct sunlight.
- Do not dry using drying devices such as dryers.
- Once the air filter is dried, proceed to "Attaching the air filter unit" (➡ page 199) next.

---

**Attaching the air filter unit**

---

**1) Attach the air filter unit to the projector.**

- Attach the air filter unit in the reverse procedure of Step 3) in "Removing the air filter unit" (➡ page 198).
- Push in the air filter unit all the way in until it clicks.

**2) Attach the air filter cover.**

- Close the air filter cover in the reverse procedure of Step 2) in "Removing the air filter unit" (➡ page 198), and press it in all the way until it clicks.
- Securely tighten the air filter cover fixing screw (x 1) using a Phillips screwdriver.

### Resetting the filter counter

---

- 1) Turn on the power of the projector.
- 2) Press the <MENU> button on the remote control or control panel.
  - The [MAIN MENU] screen is displayed.
- 3) Press ▲▼ to select [PROJECTOR SETUP].
- 4) Press the <ENTER> button.
  - The [PROJECTOR SETUP] screen is displayed.
- 5) Press ▲▼ to select [FILTER COUNTER].
- 6) Press the <ENTER> button.
  - The [FILTER COUNTER] screen is displayed.
- 7) Press ▲▼ to select [FILTER COUNTER RESET], and press the <ENTER> button.
- 8) The confirmation screen is displayed, so press ◀▶ to select [OK], and press the <ENTER> button.
  - Display of [FILTER COUNTER] will change to [0 H].

#### Attention

---

- After washing the air filter unit, dry it thoroughly before attaching it back to the projector. Attaching a wet unit will cause an electric shock or malfunction.
- Do not disassemble the air filter unit.
- Make sure that the air filter unit is properly attached before using the projector. If it is not attached, the projector will suck in dirt and dust causing a malfunction.
- Do not insert object from the hole of the air intake port. Doing so may cause damage.

#### Note

---

- When the projector is used without resetting the filter counter, the actual filter runtime (counter numeric value) will not be able to be confirmed.
- When the projector is used without attaching the air filter unit, the filter indicator <FILTER> will blink in red, and a message is displayed on the projected image for approximately 30 seconds.
- When the air filter unit is damaged or dirt does not come off even if it is washed, replace with the new optional Replacement Filter Unit (Model No.: ET-RFM100).
- Replacement to a new air filter unit is recommended after washing it twice.
- The dust-proof properties may be reduced after each cleaning.
- The replacement cycle of the air filter unit varies greatly depending on the usage environment.

### Replacing the unit

---

#### Air filter unit

---

Air filter unit should be replaced if the dirt does not come off after cleaning.

The Replacement Filter Unit (Model No.: ET-RFM100) is an optional accessory. To purchase the product, consult your dealer.



---

## Air filter unit replacement procedure

---

### Attention

---

- Make sure to turn off the projector before replacing the filter.
- When attaching the air filter unit, make sure to secure the stability of the projector, and execute in a safe location even if the air filter unit falls accidentally.

#### 1) Remove the air filter unit.

- Refer to “Removing the air filter unit” (➔ page 198).

#### 2) Attach the optional Replacement Filter Unit (Model No.: ET-RFM100) to the projector.

- The air filter unit has no difference between top and bottom, but is two-sided. Match the protrusion position of the air filter unit with the grooves on the projector body.
- Refer to “Attaching the air filter unit” (➔ page 199).

### Attention

---

- When switching on the projector, make sure that the air filter unit is attached. If it is not attached, the projector will suck in dirt and dust causing a malfunction.
- When the projector is used without attaching the air filter unit, the filter indicator <FILTER> will blink in red, and a message is displayed on the projected image for approximately 30 seconds.

### Note

---

- The replacement cycle of the air filter unit varies greatly depending on the usage environment.

# Troubleshooting

Review the following points. For details, see the corresponding pages.

Problems	Points to be checked	Page
<b>Power does not turn on.</b>	• Is the power plug firmly inserted into the outlet?	—
	• Is the <MAIN POWER> switch set to <OFF>?	65
	• Is the wall outlet supplying electricity?	—
	• Have the circuit breakers tripped?	—
	• Is the light source indicator <LIGHT> blinking?	196
	• Is the temperature indicator <TEMP> lit or blinking?	197
<b>No image appears.</b>	• Are connections to external devices correctly performed?	51
	• Is the input selection setting correct?	66
	• Is the [BRIGHTNESS] adjustment setting at a minimum?	84
	• Is the external device that is connected to the projector working properly?	—
	• Is the shutter function in use?	71, 108
	• If the power indicator <ON (G)/STANDBY (R)> is blinking in red, consult your dealer.	—
<b>Image is fuzzy.</b>	• Is the lens focus set correctly?	67
	• Is the projection distance appropriate?	37
	• Is the lens dirty?	25
	• Is the projector installed perpendicular to the screen?	—
<b>Color is pale or grayish.</b>	• Are [COLOR] and [TINT] adjusted correctly?	85
	• Is the external device connected to the projector adjusted correctly?	51
	• Is the computer cable damaged?	—
<b>Audio is not output.</b>	• Is the external device connected correctly to the audio input terminal?	32
	• Is the volume set to minimum?	72, 122
	• Is the mute function used?	71, 123
	• Is [AUDIO IN SELECT] in [AUDIO SETTING] correctly set?	123
	• Is there a cable connected to the <VARIABLE AUDIO OUT> terminal? Audio is not output from the built-in speaker when a cable is connected.	52, 123
<b>Remote control does not respond.</b>	• Are the batteries depleted?	—
	• Is the polarity of the batteries set correctly?	33
	• Are there any obstructions between the remote control and the remote control signal receiver of the projector?	29
	• Is the remote control being used beyond its effective operation range?	29
	• Are other forms of light, such as fluorescent light, affecting the projection?	29
	• Is the [REMOTE CONTROL] setting in [CONTROL DEVICE SETUP] set to [DISABLE]?	137
	• Is the ID number setting operation correct?	76
<b>Menu screen does not appear.</b>	• Is the on-screen display function turned off (hidden)?	72
<b>Buttons on the control panel do not operate.</b>	• Is the [CONTROL PANEL] setting in [CONTROL DEVICE SETUP] set to [DISABLE]?	137
<b>Image does not display correctly.</b>	• Is [SYSTEM SELECTOR] set properly?	88
	• Is there a problem with the video tape or other image sources?	—
	• Is a signal which is not compatible with the projector being input?	217
<b>Image from a computer does not appear.</b>	• Is the cable too long? (For D-Sub cables, the cable length should be 10 m (32'10") or shorter.)	—
	• Is the external video output on the laptop computer set correctly? (Ex.: The external output settings may be switched by pressing the "Fn" + "F3" keys or the "Fn" + "F10" keys simultaneously. This will differ depending on the model of the computer. Refer to the user manual provided with your computer.)	—
<b>Video from HDMI compatible device does not appear or it appears jumbled.</b>	• Is the HDMI cable connected securely?	51
	• Turn the power of the projector and the external device off and on.	—
	• Is a signal which is not compatible with the projector being input?	217
<b>No audio is coming from the HDMI compatible device.</b>	• Set the audio for connected device to linear PCM.	—

## Chapter 6 Maintenance — Troubleshooting

Problems	Points to be checked	Page
<b>The DIGITAL LINK input image is not displayed.</b>	• Is the cable compatible to the condition of the projector used?	54
	• Are the connections between the twisted-pair-cable transmitter and an external device, and between the twisted-pair-cable transmitter and projector correctly done?	—
	• Is [DIGITAL LINK MODE] set to [AUTO] or [DIGITAL LINK]? Is it set to [ETHERNET]?	139
	• Is a signal which is not compatible with a twisted-pair-cable transmitter being input?	—
<b>Light ID cannot be received.</b>	• When [LIGHT POWER] in [ECO MANAGEMENT] is set to anything other than [NORMAL], the [LightID] setting is disabled, and it will be fixed to [OFF].	113
	• Depending on the surrounding environment such as distance or brightness, receiving of the Light ID signal may become difficult.	23

### Attention

- If problems persist even after checking the preceding points, consult your dealer.

## FAQ

Refer to this section when there is a problem with the wireless LAN connection or connection with the mirroring function (noted as “mirroring connection” hereafter).

### Wireless LAN connection

#### ■ Wireless LAN connection cannot be established.

- To use the wireless LAN function with the projector, it is necessary to attach the optional Wireless Module (Model No.: ET-WM300).  
For details on how to attach the optional Wireless Module (Model No.: ET-WM300), refer to “Attaching the Wireless Module” (➔ page 50).
- Is the [NETWORK/USB] menu → [WIRELESS LAN] set to [DISABLE]?
- Confirm the settings of the device.
- Is there an obstacle between the device and the projector? Or, is the device too far away from the projector?
- Set the [NETWORK/USB] menu → [WIRELESS LAN] to [DISABLE] once, and then perform the wireless LAN connection operation again. Restoration process of the built-in Wireless Module is performed, which may enable the connection.

#### ■ Image of the Panasonic APPLICATION input is disrupted.

- Under certain reception conditions, the image may be disrupted. In such a case, try the following.
  - Move the device to perform wireless LAN connection closer to the projector.
  - Install the projector away from other device that emits electromagnetic radiation, such as microwave oven, gaming device, etc. If it does not improve, refrain from using other devices that emit electromagnetic radiation.
  - The bandwidth of the wireless may not be sufficient when multiple wireless LAN devices are connected to a single router. Turn off the devices which are not used or refrain from using other devices.
  - Where possible, try not use the projector in a location where excessive static electricity or noise is generated.

### Mirroring connection

#### ■ Mirroring connection is not established.

- Is the input set to MIRRORING?
- Is the [NETWORK/USB] menu → [WIRELESS LAN] set to [DISABLE]?
- Confirm the settings of the device.
- Is there an obstacle between the device and the projector? Or, is the device too far away from the projector?
- Connection may not be established correctly right after the device has restored from the sleep status, or right after switching the logon user. Turn the wireless LAN of the device off once and then on again, or restart the device.

#### ■ The connection is disconnected and the image is not updating.

- Try the following when the mirroring connection is disconnected.
  - With the [PROJECTOR SETUP] menu → [ECO MANAGEMENT] → [STANDBY MODE] set to [ECO], turn the power of the projector off once and then back on.
  - After turning off the projector, reconnect the plug of the power cord to the outlet.
  - Restart the device.

#### ■ Image of the MIRRORING input is disrupted.

- Under certain reception conditions, the image may be disrupted. In such a case, try the following.
  - Move the device to perform wireless LAN connection closer to the projector.
  - Install the projector away from other device that emits electromagnetic radiation, such as microwave oven, gaming device, etc. If it does not improve, refrain from using other devices that emit electromagnetic radiation.
  - The bandwidth of the wireless may not be sufficient when multiple wireless LAN devices are connected to a single router. Turn off the devices which are not used or refrain from using other devices.
  - Where possible, try not use the projector in a location where excessive static electricity or noise is generated.
  - When the [NETWORK/USB] menu → [WIRELESS LAN] is set to [USER], it may improve when setting is changed to [SIMPLE] or [M-DIRECT]. End the mirroring connection once, and re-connect.

- It may improve by ending the mirroring connection once, and then change to a different channel in the [NETWORK/USB] menu → [MIRRORING] → [CHANNEL]. End the mirroring connection once, and re-connect.
  - Confirm that there is no problem with the used contents.
  - It may be caused by the processing performance or the wireless transfer performance of the device in use. Confirm the specification of the device.
- **The connection was disconnected when not doing anything after performing the mirroring connection.**
- Depending on the device in use, it may be set to disconnect the connection after specific time has elapsed. Confirm the energy saving setting, etc., of the device.
  - It may improve by updating the firmware of the device in use or the driver of the wireless LAN. Consult with the customer support for the device.
- **Other**
- Depending on the device in use, confirmation screen for reconnection with the connection name of “from UNKNOWN” may display, but reconnection cannot be performed from that screen.
  - Depending on the device in use, it may be requested to “delete the device” at the time of connection. In such case, delete the device following the instruction of the device.

## [SELF TEST] display

[SELF TEST] can be checked in the [PROJECTOR SETUP] menu → [STATUS] → [SELF TEST].

The following list shows the alphanumeric symbol that is displayed when an error or a warning has occurred and its details. Confirm “Action number”, and follow the measure in “Measure for error and warning” (➔ page 207).

Error/warning display	Details	Action number
U04	Filter clogging warning	6
U11	Intake temperature warning	1
U13	Exhaust air temperature warning	1
U16	Light source temperature 1 warning	1
U18	Light source temperature 2 warning	1
U21	Intake temperature error	1
U23	Exhaust air temperature error	1
U25	Light source temperature 1 error	1
U27	Light source temperature 2 error	1
U76	Filter not attached warning	6
U78	Filter clogging error	6
U84	<DC OUT> terminal power supply error	4
H01	Battery replacement for the internal clock	3
H11	Intake air temperature sensor error	4
H13	Exhaust air temperature sensor error	4
H14	Light source temperature sensor 1 error	4
H16	Light source temperature sensor 2 error	4
H18	Clog temperature sensor error	4
F16	Angle sensor error	4
F18	Air pressure sensor error	4
F50	Power source intake fan warning	4
F51	Power source exhaust fan warning	4
F52	LCD panel red fan warning	4
F53	LCD panel green fan warning	4
F54	LCD panel blue fan warning	4
F55	PBS fan warning	4
F56	Phosphor wheel fan warning	4
F57	Light source fan warning	4
F58	Backup fan warning	4
F61	Light source driver communication error	4
F90	FPGA configuration error	4
F96	Lens mounter operation error	4
FE1	Power supply intake fan error	4
FE2	Power supply exhaust fan error	4
FE3	LCD panel red fan error	4
FE4	LCD panel green fan error	4
FE5	LCD panel blue fan error	4
FE6	PBS fan error	4
FE7	Phosphor wheel fan error	4
FE8	Light source fan error	4
FE9	Backup fan error	4
FH0	PW ERROR (FM/SUB)	4
FH1	Phosphor wheel error	4
FL1	Light source unit error	5
FL5	Light source bank 1 warning	4
FL6	Light source bank 2 warning	4
FL7	Light source bank 3 warning	4
FL8	Light source bank 4 warning	4

### Note

- The self-diagnosis display and the details of the malfunction may be different.
- For errors and warnings that are not described in the table, consult your dealer.

■ Measure for error and warning

Action number	Measure
1	The operating environment temperature is too high. Use the projector in an appropriate operating environment temperature*1.
2	The operating environment temperature is too low. Use the projector in an appropriate operating environment temperature*1.
3	Battery replacement is required. Consult your dealer.
4	If the display does not clear after switching the main power off and on, consult your dealer.
5	The light source has failed to turn on. If the light source does not light up after turning the power off and on, consult your dealer.
6	Perform maintenance or replacement of the filter. (➡ page 198)

\*1 For the operating environment temperature of the projector, refer to “Operating environment temperature” (➡ page 220).

# Chapter 7 Appendix

---

This chapter describes specifications and after-sales service for the projector.



# Technical information

## PJLink protocol

The network function of this projector supports the PJLink class 1 and class 2, and setting of the projector or querying of the projector status can be performed from the computer using the PJLink protocol.

### Control commands

The following table lists the PJLink protocol commands that can be used to control the projector.

• x characters in tables are non-specific characters.

Class	Command	Control details	Parameter/response string	Remark		
1	POWR	Power supply control	0 1	Standby Power on		
1	POWR?	Power supply status query	0 1 2	Standby Power on Preparing for switching off the projector		
1, 2	INPT	Input selection	11 12 21	RGB1 RGB2 VIDEO		
	INPT?	Input selection query	31 32 33 41 51 52	HDMI1 HDMI2 DIGITAL LINK MEMORY VIEWER Panasonic APPLICATION MIRRORING		
1	AVMT	Shutter control/audio output control	10 11 20	Shutter function disabled (shutter: open), mute function disabled Shutter function enabled (shutter: closed), mute function disabled Shutter function disabled (shutter: open), mute function disabled		
	AVMT?	Shutter status query/audio output status query	21 30 31	Shutter function disabled (shutter: open), mute function enabled (muted) Shutter function disabled (shutter: open), mute function disabled Shutter function enabled (shutter: closed), mute function enabled (muted)		
1	ERST?	Error status query	xxxxxx	1st byte	Indicates fan errors, and returns 0 or 2.	<ul style="list-style-type: none"> <li>• 0 = No error is detected</li> <li>• 1 = Warning</li> <li>• 2 = Error</li> </ul>
				2nd byte	Indicates light source errors, and returns 0 or 2.	
				3rd byte	Indicates temperature errors, and returns 0 - 2.	
				4th byte	Returns 0.	
				5th byte	Returns 0.	
				6th byte	Indicates other errors, and returns 0 - 2.	
1	LAMP?	Light source status query	AAAA X	AAAA: Light source runtime X: 0 = Light source off, 1 = Light source on		
1, 2	INST?	Input selection list query	11 12 21 31 32 33 41 51 52	—		
1	NAME?	Projector name query	xxxxx	Returns the name set in the [NETWORK/USB] menu → [PROJECTOR NAME].		
1	INF1?	Manufacturer name query	Panasonic	Returns manufacturer name.		
1	INF2?	Model name query	PT-MZ670 PT-MW630 PT-MZ570 PT-MW530	Returns model name.		
1	INF0?	Other information queries	xxxxx	Returns information such as version number.		
1	CLSS?	Class information query	2	Returns class for PJLink.		
2	SNUM ?	Serial number query	xxxxxxxxx	Returns serial number.		
2	SVER ?	Software version query	xxxxxxxxx	Returns version number.		

Class	Command	Control details	Parameter/response string	Remark
2	INNM ?	Input terminal name query	11 / RGB1 12 / RGB2 21 / VIDEO 31 / HDMI1 32 / HDMI2 33 / DIGITAL LINK 41 / MEMORY VIEWER 51 / PANASONIC APPLICATION 52 / MIRRORING	Returns input terminal name.
2	IRES ?	Input signal resolution query	AAAAxBBBB	AAAA: Horizontal resolution BBBB: Vertical resolution
2	RRES ?	Recommended resolution query	1920x1200 1280 x 800	Only for PT-MZ670, PT-MZ570 Only for PT-MW630, PT-MW530
2	FILT ?	Filter runtime inquiry	xxxxx	Returns the runtime of the filter.
2	RFIL ?	Filter replacement model number inquiry	ET-RFM100	Returns the filter replacement model number.
2	SVOL	Speaker volume	0 1	Increases the volume. Decreases the volume.
2	FREZ FREZ ?	Freeze control Freeze status query	0 1	Freeze function cancel Freeze function (stop)
2	LKUP	Link up notification	xx:xx:xx:xx:xx:xx	Notifies the MAC address when the PJLink communication becomes possible.
2	SRCH	Projector search	ACKN=xx:xx:xx:xx:xx:xx	The projector connected to the same network that can communicate with PJLink will respond with its MAC address.

### PJLink security authentication

The password used for PJLink is the same as that of the password set for web control.

When using the projector without security authentication, do not set a password for web control.

- For specifications related to PJLink, visit the website of Japan Business Machine and Information System Industries Association.

URL <http://pjlink.jbmia.or.jp/english/>

### Control commands via LAN

#### When web control administrator rights password is set (Protect mode)

##### Connecting

- 1) Obtain the IP address and port number (Initial set value = 1024) of the projector and request a connection to the projector.

- You can obtain both the IP address and the port number from the menu screen of the projector.

<b>IP address</b>	Obtain from the [NETWORK/USB] menu → [NETWORK STATUS].
<b>Port number</b>	Obtain from the [NETWORK/USB] menu → [NETWORK CONTROL] → [COMMAND PORT].

- 2) Check the response from the projector.

	Data section	Blank	Mode	Blank	Random number section	Termination symbol
<b>Command example</b>	"NTCONTROL" (ASCII string)	' '	'1'	' '	"zzzzzzz" (ASCII code hex number)	(CR) 0x0d
<b>Data length</b>	9 bytes	1 byte	1 byte	1 byte	8 bytes	1 byte

- Mode: 1 = Protect mode
- Example: Response during protect mode (random number section is undefined value)  
"NTCONTROL 1 23181e1e" (CR)

3) Generate a 32-byte hash value from the following data using MD5 algorithm.

- “xxxxxx:yyyyy:zzzzzzzz”

<b>xxxxxx</b>	Administrator rights user name for the web control (default user name is “dispadmin”)
<b>yyyyy</b>	Password of above administrator rights user (default password is “@Panasonic”)
<b>zzzzzzzz</b>	8-byte random number obtained in Step 2)

**Command transmission method**

Transmit using the following command formats.

■ Transmitted data

	Header			Data section	Termination symbol
<b>Command example</b>	Hash value “Connecting” (➔ page 210)	‘0’ 0x30	‘0’ 0x30	Control command (ASCII string)	(CR) 0x0d
<b>Data length</b>	32 bytes	1 byte	1 byte	Undefined length	1 byte

- Example: Transmission of power supply status acquisition command (hash value is calculated from default user name, password, and acquired random number)  
“dbdd2dabd3d4d68c5dd970ec0c29fa6400QPW” (CR)

■ Received data

	Header		Data section	Termination symbol
<b>Command example</b>	‘0’ 0x30	‘0’ 0x30	Control command (ASCII string)	(CR) 0x0d
<b>Data length</b>	1 byte	1 byte	Undefined length	1 byte

- Example: The projector is powered on  
“00001” (CR)

■ Error response

	String	Details	Termination symbol
<b>Message</b>	“ERR1”	Undefined control command	(CR) 0x0d
	“ERR2”	Out of parameter range	
	“ERR3”	Busy state or no-acceptable period	
	“ERR4”	Timeout or no-acceptable period	
	“ERR5”	Wrong data length	
	“ERRA”	Password mismatch	
<b>Data length</b>	4 bytes	—	1 byte

**When web control administrator rights password is not set (Non-protect mode)**

**Connecting**

1) Obtain the IP address and port number (Initial set value = 1024) of the projector and request a connection to the projector.

- You can obtain both the IP address and the port number from the menu screen of the projector.

<b>IP address</b>	Obtain from the [NETWORK/USB] menu → [NETWORK STATUS].
<b>Port number</b>	Obtain from the [NETWORK/USB] menu → [NETWORK CONTROL] → [COMMAND PORT].

2) Check the response from the projector.

	Data section	Blank	Mode	Termination symbol
<b>Command example</b>	"NTCONTROL" (ASCII string)	' ' 0x20	'0' 0x30	(CR) 0x0d
<b>Data length</b>	9 bytes	1 byte	1 byte	1 byte

- Mode: 0 = Non-protect mode
- Example: Response during non-protect mode  
"NTCONTROL 0" (CR)

### Command transmission method

Transmit using the following command formats.

#### ■ Transmitted data

	Header		Data section	Termination symbol
<b>Command example</b>	'0' 0x30	'0' 0x30	Control command (ASCII string)	(CR) 0x0d
<b>Data length</b>	1 byte	1 byte	Undefined length	1 byte

- Example: Transmission of power supply status acquisition command  
"00QPW" (CR)

#### ■ Received data

	Header		Data section	Termination symbol
<b>Command example</b>	'0' 0x30	'0' 0x30	Control command (ASCII string)	(CR) 0x0d
<b>Data length</b>	1 byte	1 byte	Undefined length	1 byte

- Example: The power of the projector is in standby status  
"00000" (CR)

#### ■ Error response

	String	Details	Termination symbol
<b>Message</b>	"ERR1"	Undefined control command	(CR) 0x0d
	"ERR2"	Out of parameter range	
	"ERR3"	Busy state or no-acceptable period	
	"ERR4"	Timeout or no-acceptable period	
	"ERR5"	Wrong data length	
	"ERRA"	Password mismatch	
<b>Data length</b>	4 bytes	—	1 byte

## <SERIAL IN> terminal

The <SERIAL IN> terminal of the projector conforms with RS-232C so that the projector can be connected to and controlled from a computer.

### Connection

#### When connecting directly

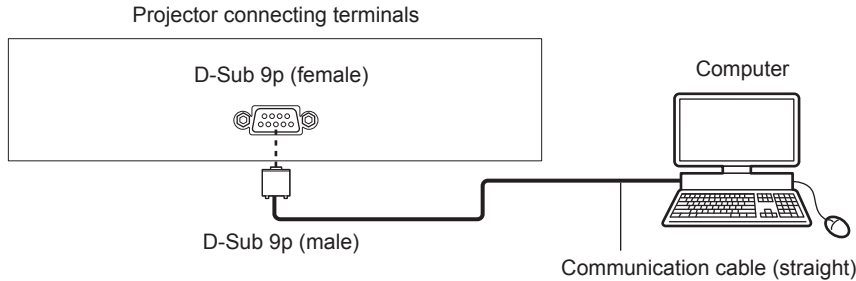

#### When connecting using DIGITAL LINK compatible device

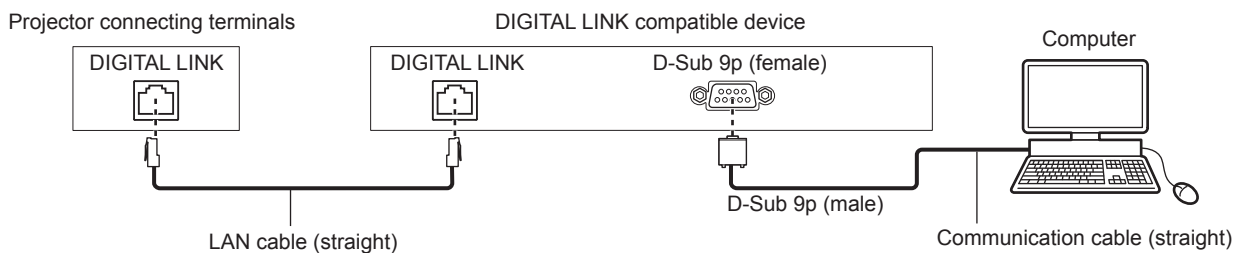

### Note

- The destination of [RS-232C] (➔ page 119) must be set according to the connection method.
- When connecting using a DIGITAL LINK compatible device, set the [PROJECTOR SETUP] menu → [ECO MANAGEMENT] → [STANDBY MODE] to [NORMAL] to control the projector in the standby mode.  
When [STANDBY MODE] is set to [ECO], the projector cannot be control during standby.

### Pin assignments and signal names

D-Sub 9-pin (female) Outside view	Pin No.	Signal name	Details
	(1)	—	NC
	(2)	TXD	Transmitted data
	(3)	RXD	Received data
	(4)	—	NC
	(5)	GND	Earth
	(6)	—	NC
	(7)	CTS	Connected internally
	(8)	RTS	
	(9)	—	NC

### Communication conditions (Factory default)

Signal level	RS-232C-compliant
Sync. method	Asynchronous
Baud rate	9 600 bps
Parity	None
Character length	8 bits
Stop bit	1 bit
X parameter	None
S parameter	None

**Basic format**

Transmission from the computer starts with STX, then the ID, command, parameter, and ETX are sent in this order. Add parameters according to the details of control.

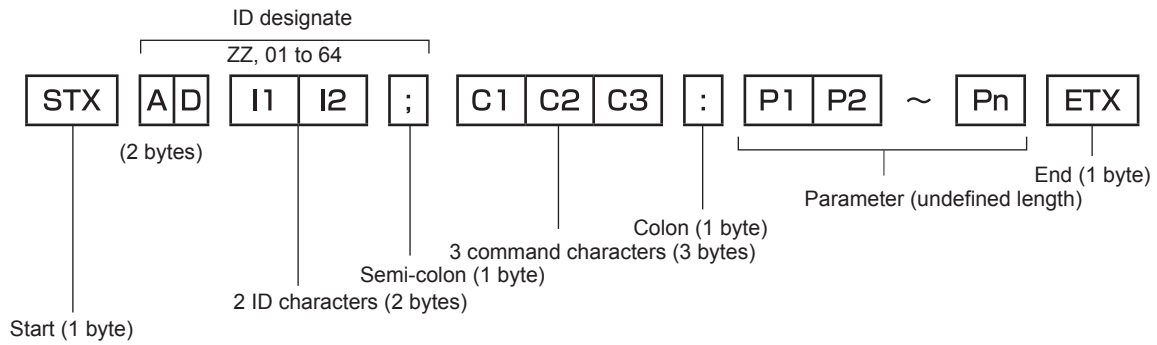

**Basic format (has subcommands)**

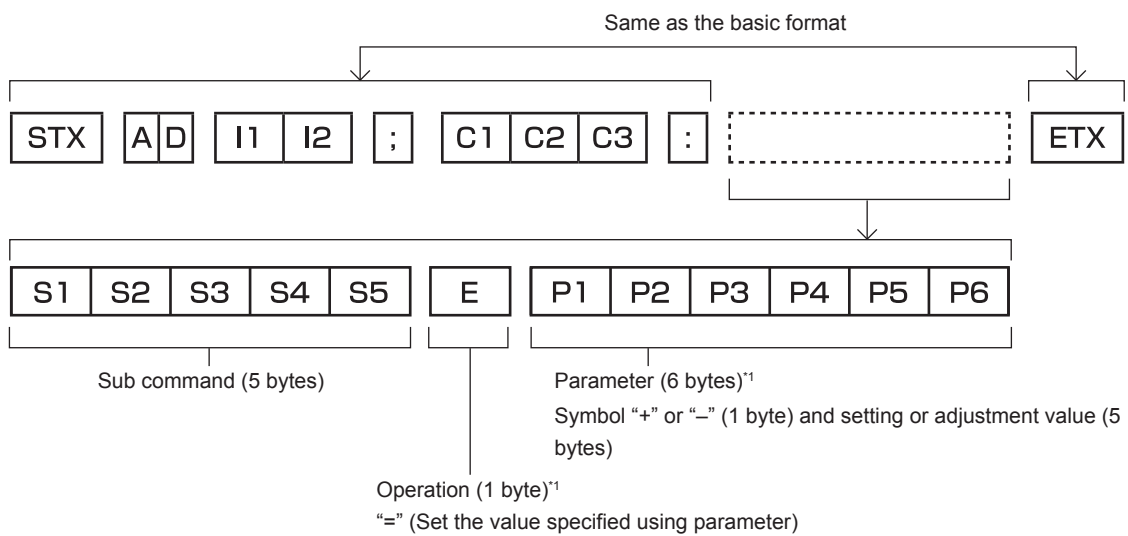

\*1 When transmitting a command which does not need a parameter, an operation (E) and parameter are not necessary.

**Attention**

- If a command is sent after the light source starts lighting, there may be a delay in response or the command may not be executed. Try sending or receiving any command after 60 seconds.
- When transmitting multiple commands, be sure to wait until 0.5 seconds has elapsed after receiving the response from the projector before sending the next command. When transmitting a command which does not need a parameter, a colon (:) is not necessary.

**Note**

- If a command cannot be executed, the "ER401" response is sent from the projector to the computer.
- If an invalid parameter is sent, the "ER402" response is sent from the projector to the computer.
- ID transmission in RS-232C supports ZZ (ALL) and 01 to 64.
- If a command is sent with an ID designated, a response will be sent to the computer only in the following cases.
  - It matches the projector ID
  - When the [PROJECTOR SETUP] menu → [PROJECTOR ID] is set to [ALL] on the projector
- STX and ETX are character codes. STX shown in hexadecimal is 02, and ETX shown in hexadecimal is 03.

**Cable specification**

**When connected to a computer**

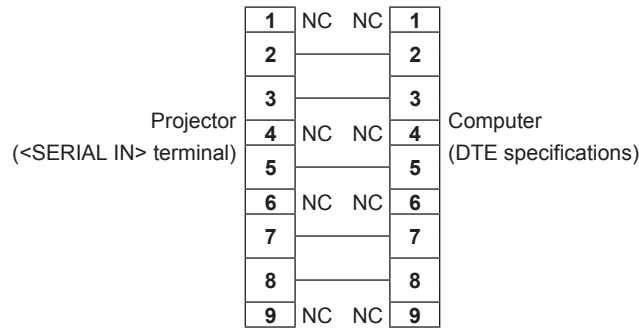

**Control command**

The following table lists the commands that can be used to control the projector using a computer.

■ **Projector control command**

Command	Details	Parameter/response string	Remark (parameter)
PON	Power on	—	To check if the power is on, use the “Power query” command.
POF	Power standby		
QPW	Power query	000 001	STANDBY Power on
IIS	Switching the input signal	VID RG1 RG2 HD1 HD2 DL1 PA1 MC1 MV1	VIDEO RGB1 RGB2 HDMI1 HDMI2 DIGITAL LINK Panasonic APPLICATION MIRRORING MEMORY VIEWER
OSH	Shutter control	0	OPEN
QSH	Shutter status query	1	CLOSE
VSE	Aspect ratio switch	0 1 2 5	NORMAL/VID AUTO 4:3 WIDE NATIVE
QSE		Aspect ratio settings query	6 9 10
OCS	Sub memory switch	01 - 96	Sub memory number
QSB	Sub memory status query		

## <REMOTE 1 IN> terminal

The projector can be remotely controlled (contact control) by the control board that is located far away from the projector where the signal from the remote control does not reach.

Use the <REMOTE 1 IN> terminal on the connecting terminals of the projector to connect to the control board.

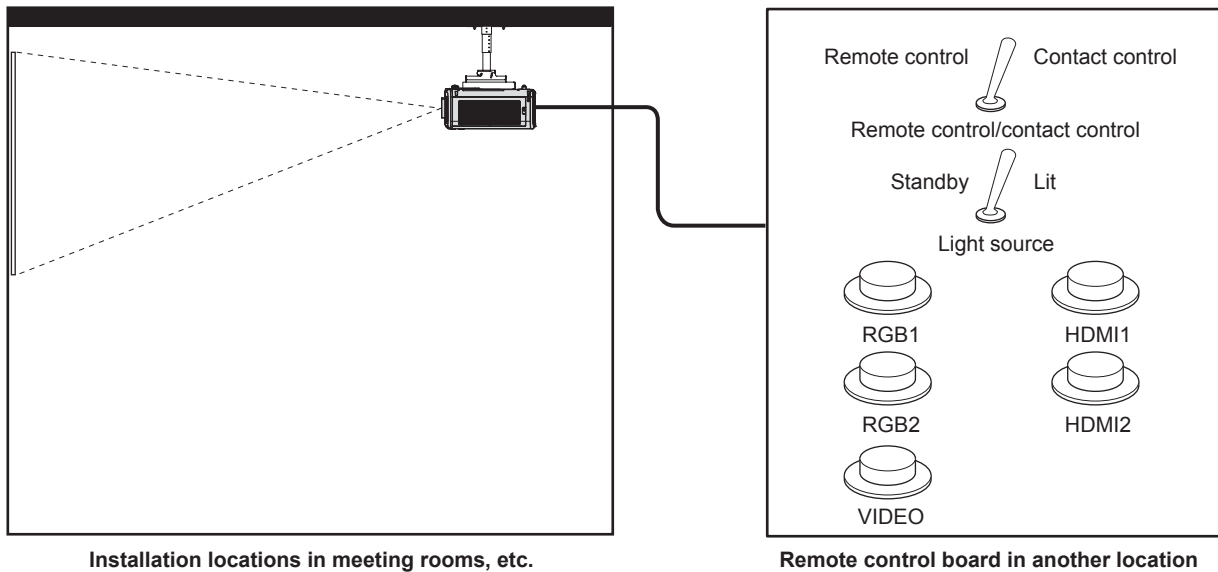

## Pin assignments and signal names

D-Sub 9-pin Outside view	Pin No.	Signal name	Open (H)	Short (L)
	(1)	GND	—	GND
	(2)	POWER	OFF	ON
	(3)	RGB1	Other	RGB1
	(4)	RGB2	Other	RGB2
	(5)	VIDEO	Other	VIDEO
	(6)	HDMI1	Other	HDMI1
	(7)	HDMI2	Other	HDMI2
	(8)	SHUTTER	OFF	ON
	(9)	RST/SET	Controlled by remote control	Controlled by external contact

### Attention

- When controlling, make sure to short-circuit pins (1) and (9).
- When pins (1) and (9) are short-circuited, the following buttons on the control panel and the remote control are disabled. Commands for RS-232C and network functions corresponding to these functions are also disabled.
  - Power <⏻/⏪> button, <SHUTTER> button
- When pins (1) and (9) are short-circuited, and then any pins from (3) to (7) and the pin (1) are short-circuited, the following buttons on the control panel and the remote control are disabled. Commands for RS-232C and network functions corresponding to these functions are also disabled.
  - Power <⏻/⏪> button, <INPUT SELECT> button, <RGB1/2> button, <HDMI 1> button, <HDMI 2> button, <DIGITAL LINK> button, <VIDEO> button, <NETWORK/USB> button, <SHUTTER> button

### Note

- Setting of the pin (2) to pin (8) can be changed when the [PROJECTOR SETUP] menu → [REMOTE1 MODE] is set to [USER]. (→ page 121)

## Operating [MENU LOCK PASSWORD]

To return the password to the factory default setting (AAAA), perform following operation while displaying the [MENU LOCK PASSWORD] input request screen.

- 1) Press the <AUTO SETUP/CANCEL> button on the remote control for at least three seconds.
- 2) Press ▼ for at least three seconds.



## List of compatible signals

The following table specifies the video signals compatible with the projector.

This signal with ✓ in the supported signal column is supported.

- Symbols that indicate formats are as follows.
  - V: VIDEO
  - R: RGB
  - Y: YC<sub>B</sub>C<sub>R</sub>/YP<sub>B</sub>P<sub>R</sub>
  - H: HDMI
- DIGITAL LINK input compatible signal is the same as HDMI input compatible signal.
- Input corresponding to each item in the plug and play column is as follows.
  - RGB: RGB2 input
  - HDMI/DL: HDMI1/HDMI2 input, DIGITAL LINK input

Compatible signal	Resolution (Dots)	Scanning freq.		Dot clock freq. (MHz)	Format	Plug and play <sup>*1</sup>	
		Horizontal (kHz)	Vertical (Hz)			RGB	HDMI/DL
NTSC/NTSC4.43/ PAL-M/PAL60	720 x 480i	15.7	59.9	—	V	—	—
PAL/PAL-N/SECAM	720 x 576i	15.6	50.0	—	V	—	—
480/60i	720 x 480i	15.7	59.9	13.5	R/Y	—	—
576/50i	720 x 576i	15.6	50.0	13.5	R/Y	—	—
480/60i	720 (1 440) x 480i <sup>2</sup>	15.7	59.9	27.0	H	—	—
576/50i	720 (1 440) x 576i <sup>2</sup>	15.6	50.0	27.0	H	—	—
480/60p	720 x 480	31.5	59.9	27.0	R/Y/H	—	✓
576/50p	720 x 576	31.3	50.0	27.0	R/Y/H	—	✓
720/60p	1 280 x 720	45.0	60.0	74.3	R/Y/H	—	✓
720/50p	1 280 x 720	37.5	50.0	74.3	R/Y/H	—	✓
1080/60i	1 920 x 1 080i	33.8	60.0	74.3	R/Y/H	—	✓
1080/50i	1 920 x 1 080i	28.1	50.0	74.3	R/Y/H	—	✓
1080/24p	1 920 x 1 080	27.0	24.0	74.3	R/Y/H	—	✓
1080/24sF	1 920 x 1 080i	27.0	48.0	74.3	R/Y/H	—	—
1080/25p	1 920 x 1 080	28.1	25.0	74.3	R/Y/H	—	—
1080/30p	1 920 x 1 080	33.8	30.0	74.3	R/Y/H	—	—
1080/60p	1 920 x 1 080	67.5	60.0	148.5	R/Y/H	—	✓
1080/50p	1 920 x 1 080	56.3	50.0	148.5	R/Y/H	—	✓
640 x 400/70	640 x 400	31.5	70.1	25.2	R/H	—	—
640 x 400/85	640 x 400	37.9	85.1	31.5	R/H	—	—
640 x 480/60	640 x 480	31.5	59.9	25.2	R/H	✓	✓
640 x 480/67	640 x 480	35.0	66.7	30.2	R/H	—	—
640 x 480/73	640 x 480	37.9	72.8	31.5	R/H	✓	✓
640 x 480/75	640 x 480	37.5	75.0	31.5	R/H	✓	✓
640 x 480/85	640 x 480	43.3	85.0	36.0	R/H	—	—
800 x 600/56	800 x 600	35.2	56.3	36.0	R/H	✓	✓
800 x 600/60	800 x 600	37.9	60.3	40.0	R/H	✓	✓
800 x 600/72	800 x 600	48.1	72.2	50.0	R/H	✓	✓
800 x 600/75	800 x 600	46.9	75.0	49.5	R/H	✓	✓
800 x 600/85	800 x 600	53.7	85.1	56.3	R/H	—	—
832 x 624/75	832 x 624	49.7	74.6	57.3	R/H	✓	✓
1024 x 768/50	1 024 x 768	39.6	50.0	51.9	R/H	—	—
1024 x 768/60	1 024 x 768	48.4	60.0	65.0	R/H	✓	✓
1024 x 768/70	1 024 x 768	56.5	70.1	75.0	R/H	✓	✓
1024 x 768/75	1 024 x 768	60.0	75.0	78.8	R/H	✓	✓
1024 x 768/82	1 024 x 768	65.5	81.6	86.0	R/H	—	—
1024 x 768/85	1 024 x 768	68.7	85.0	94.5	R/H	—	—
1024 x 768/100	1 024 x 768	81.4	100.0	113.3	R/H	—	—
1152 x 864/60	1 152 x 864	53.7	60.0	81.6	R/H	—	—

## Chapter 7 Appendix — Technical information

Compatible signal	Resolution (Dots)	Scanning freq.		Dot clock freq. (MHz)	Format	Plug and play <sup>*1</sup>	
		Horizontal (kHz)	Vertical (Hz)			RGB	HDMI/DL
1152 x 864/75	1 152 x 864	67.5	75.0	108.0	R/H	—	—
1152 x 864/85	1 152 x 864	77.1	85.0	119.7	R/H	—	—
1152 x 870/75	1 152 x 870	68.7	75.1	100.0	R/H	✓	✓
1280 x 720/50	1 280 x 720	37.1	49.8	60.5	R/H	—	—
1280 x 720/60	1 280 x 720	44.8	59.9	74.5	R/H	—	—
1280 x 768/50	1 280 x 768	39.6	49.9	65.3	R/H	—	—
1280 x 768/60	1 280 x 768	47.7	60.0	80.1	R/H	—	—
	1 280 x 768	47.8	59.9	79.5	R/H	—	—
1280 x 768/75	1 280 x 768	60.3	74.9	102.3	R/H	—	—
1280 x 768/85	1 280 x 768	68.6	84.8	117.5	R/H	—	—
1280 x 800/50	1 280 x 800	41.3	50.0	68.0	R/H	—	—
1280 x 800/60	1 280 x 800	49.7	59.8	83.5	R/H	✓ <sup>*3</sup>	✓ <sup>*3</sup>
1280 x 800/75	1 280 x 800	62.8	74.9	106.5	R/H	—	—
1280 x 800/85	1 280 x 800	71.6	84.9	122.5	R/H	—	—
1280 x 960/60	1 280 x 960	60.0	60.0	108.0	R/H	—	—
1280 x 1024/50	1 280 x 1 024	52.4	50	88.0	R/H	—	—
1280 x 1024/60	1 280 x 1 024	64.0	60.0	108.0	R/H	—	—
1280 x 1024/75	1 280 x 1 024	80.0	75.0	135.0	R/H	✓	✓
1280 x 1024/85	1 280 x 1 024	91.1	85.0	157.5	R/H	—	—
1366 x 768/50	1 366 x 768	39.6	49.9	69.0	R/H	—	—
1366 x 768/60	1 366 x 768	47.7	59.8	85.5	R/H	—	—
1400 x 1050/50	1 400 x 1 050	54.1	50	99.9	R/H	—	—
1400 x 1050/60	1 400 x 1 050	65.2	60.0	122.6	R/H	—	—
	1 400 x 1 050	65.3	60.0	121.8	R/H	—	—
1400 x 1050/75	1 400 x 1 050	82.2	75.0	155.9	R/H	—	—
1440 x 900/50	1 440 x 900	46.3	50.0	87.4	R/H	—	—
1440 x 900/60	1 440 x 900	55.9	59.9	106.5	R/H	—	—
1600 x 900/50	1 600 x 900	46.4	49.9	96.5	R/H	—	—
1600 x 900/60	1 600 x 900	55.9	60.0	119.0	R/H	—	—
1600 x 1200/50	1 600 x 1 200	61.8	49.9	131.5	R/H	—	—
1600 x 1200/60	1 600 x 1 200	75.0	60.0	162.0	R/H	✓	✓
1680 x 1050/50	1 680 x 1 050	54.1	50.0	119.5	R/H	—	—
1680 x 1050/60	1 680 x 1 050	65.3	60.0	146.3	R/H	—	—
1920 x 1080/50	1 920 x 1 080	55.6	49.9	141.5	R/H	—	—
1920 x 1080/60	1 920 x 1 080 <sup>*4</sup>	66.6	59.9	138.5	R/H	—	—
	1 920 x 1 080 <sup>*5</sup>	67.2	60.0	173.0	R	—	—
1920 x 1200/50	1 920 x 1 200	61.8	49.9	158.3	R/H	—	—
1920 x 1200/60	1 920 x 1 200 <sup>*4</sup>	74.0	60.0	154.0	R/H	✓ <sup>*6</sup>	✓ <sup>*6</sup>
	1 920 x 1 200 <sup>*5</sup>	74.6	59.9	193.3	R	—	—

\*1 Signal with ✓ in the plug and play column is a signal described in the EDID (extended display identification data) of the projector. The signal that does not have ✓ in the plug and play column can also be input if it is described in the format column. The resolution may not be selected in the computer even if the projector is compatible for the signal that does not have ✓ in the plug and play column.

\*2 Pixel-Repetition signal (dot clock frequency 27.0 MHz) only

\*3 Only for PT-MW630/PT-MW530

\*4 VESA CVT-RB (Reduced Blanking)-compliant

\*5 Samples the pixels in the image processing circuit and projects the image.

\*6 Only for PT-MZ670/PT-MZ570

### Note

- A signal with a different resolution is converted to the number of display dots. The number of display dots is as follows.
  - PT-MZ670, PT-MZ570: 1 920 x 1 200
  - PT-MW630, PT-MW530: 1 280 x 800
- The "i" at the end of the resolution indicates an interlaced signal.
- When interlaced signals are connected, flickering may occur on the projected image.
- Even if it is the signal listed in the list of compatible signals, it may not be displayed by the projector if the video signal is recorded in a special format.

# Specifications

The specifications of the projector are as follows.

<b>Power supply</b>		100 V - 240 V ~ (100 V - 240 V alternating current), 50 Hz/60 Hz		
<b>Power consumption</b>		<b>PT-MZ670</b>	525 W (6.0 A - 2.5 A)	
		<b>PT-MW630</b>	505 W (5.9 A - 2.4 A)	
		<b>PT-MZ570</b>	450 W (5.3 A - 2.2 A)	
		<b>PT-MW530</b>	415 W (4.9 A - 2.0 A)	
<b>Power consumption (during standby)</b>		Approx. 0.5 W	When [STANDBY MODE] is set to [ECO]	
		Approx. 22 W	When [STANDBY MODE] is set to [NORMAL]	
		Approx. 47 W	When [IN STANDBY MODE] in [AUDIO SETTING] is set to [ON], maximum audio is output, and USB memory is inserted in the <VIEWER/PAIRING> terminal	
		Approx. 115 W	When [QUICK STARTUP] is set to [ON], [IN STANDBY MODE] in [AUDIO SETTING] is set to [ON], maximum audio is output, and the power is supplied from the <DC OUT> terminal	
<b>LCD panel</b>	<b>Size</b>	19.3 mm (0.76") (aspect ratio 16:10)		
	<b>Display system</b>	Transmissive LCD panel x 3, 3 primary colors system		
	<b>Drive system</b>	Active matrix		
	<b>Number of pixels</b>	<b>PT-MZ670, PT-MZ570</b>	2 304 000 pixels (1 920 x 1 200 dots)	
<b>PT-MW630, PT-MW530</b>		1 024 000 pixels (1 280 x 800 dots)		
<b>Lens*1</b>	<b>Electric zoom</b>	1.7 to 2.8:1		
	<b>Electric focus</b>	F = 1.7 to 2.3 f = 26.9 mm to 45.4 mm		
<b>Light source</b>		Laser		
<b>Light output*2*3</b>		<b>PT-MZ670, PT-MW630</b>	6 500 lm (when [LIGHT POWER] in [ECO MANAGEMENT] is set to [NORMAL])	
		<b>PT-MZ570, PT-MW530</b>	5 500 lm (when [LIGHT POWER] in [ECO MANAGEMENT] is set to [NORMAL])	
<b>Contrast ratio*2</b>		3 000 000:1 (when [DYNAMIC CONTRAST] is set to [1] or [2])		
<b>Color system</b>		7 standards (NTSC/NTSC4.43/PAL/PAL-N/PAL-M/SECAM/PAL60)		
<b>Projected image size</b>		1.02 m (40") to 10.16 m (400")*4		
<b>Image aspect ratio</b>		16:10		
<b>Projection method</b>		[FRONT/REAR]/[FLOOR/CEILING]		
<b>Speaker</b>		4.0 cm, round x 1		
<b>Audio maximum useful output power</b>		10 W (monaural)		
<b>Power cord length</b>		3.0 m (118-1/8")		
<b>Outer case</b>		Molded plastic		
<b>Outer color</b>		White		
<b>Dimensions</b>	<b>Width</b>	560 mm (22-1/16")		
	<b>Height</b>	205 mm (8-1/16") (with the feet at shortest position)		
	<b>Depth</b>	<b>PT-MZ670, PT-MZ670D, PT-MZ670A, PT-MW630, PT-MW630D, PT-MW630A, PT-MZ570, PT-MZ570D, PT-MZ570A, PT-MW530, PT-MW530D, PT-MW530A</b>	443 mm (17-7/16") (including standard zoom lens)	
		<b>PT-MZ670L, PT-MZ670LA, PT-MW630L, PT-MW630LA, PT-MZ570L, PT-MZ570LA, PT-MW530L, PT-MW530LA</b>	428 mm (16-27/32") (excluding the optional lens)	
<b>Weight</b>	<b>PT-MZ670, PT-MZ670D, PT-MZ670A, PT-MW630, PT-MW630D, PT-MW630A, PT-MZ570, PT-MZ570D, PT-MZ570A, PT-MW530, PT-MW530D, PT-MW530A</b>	Approx. 16.9 kg (37.3 lbs.)*5 (including standard zoom lens)		
	<b>PT-MZ670L, PT-MZ670LA, PT-MW630L, PT-MW630LA, PT-MZ570L, PT-MZ570LA, PT-MW530L, PT-MW530LA</b>	Approx. 16.1 kg (35.5 lbs.)*5 (excluding the optional lens)		

## Chapter 7 Appendix — Specifications

Noise level*2		32 dB	When [LIGHT POWER] in [ECO MANAGEMENT] is set to [NORMAL]
		26 dB	When [LIGHT POWER] in [ECO MANAGEMENT] is set to [QUIET]
Operating environment	Operating environment temperature	0 °C (32 °F) to 45 °C (113 °F)*6	
	Operating environment humidity	20 % to 80 % (no condensation)	
Remote control	Power supply	DC 3 V (AAA/R03/LR03 battery x 2)	
	Operating range	Within approx. 30 m (98'5") (when operated directly in front of signal receiver)	
	Weight	102 g (3.6 ozs.) (including batteries)	
	Dimensions	Width: 48 mm (1-7/8"), Height: 145 mm (5-23/32"), Depth: 27 mm (1-1/16")	

\*1 The lens for PT-MZ670L, PT-MW630L, PT-MZ570L, and PT-MW530L is sold separately.

\*2 Measurement, measuring conditions, and method of notation all comply with ISO/IEC 21118:2012 international standards.

\*3 Value is for the supplied standard zoom lens. The value varies depending on the lens.

\*4 When the Zoom Lens (Model No.: ET-ELW22) is used, the projected image size is 1.524 m (60") to 10.160 m (400").

\*5 Average value. Weight varies for each product.

\*6 The projector cannot be used at an altitude of 2 700 m (8 858') or higher above sea level.

The light output may decrease to protect the projector when the operating environment temperature exceeds 36 °C (96.8 °F).

### Note

- The model numbers of accessories and optional accessories are subject to change without prior notice.

### ■ Connecting terminal

<RGB 1 IN> terminal	1 set, BNC x 5 (RGB/YP <sub>B</sub> P <sub>R</sub> /YC <sub>B</sub> C <sub>R</sub> ) x 1 <b>RGB signal</b> 0.7 V [p-p] 75 Ω (SYNC ON GREEN: 1.0 V [p-p] 75 Ω) SYNC/HD TTL high impedance, automatic positive/negative polarity compatible VD TTL high impedance, automatic positive/negative polarity compatible <b>YP<sub>B</sub>P<sub>R</sub> signal</b> Y: 1.0 V [p-p] including synchronization signal, P <sub>B</sub> P <sub>R</sub> : 0.7 V [p-p] 75 Ω
<RGB 2 IN> terminal	1 set, high-density D-Sub 15 p (female) <b>RGB signal</b> 0.7 V [p-p] 75 Ω (SYNC ON GREEN: 1.0 V [p-p] 75 Ω) SYNC/HD TTL high impedance, automatic positive/negative polarity compatible VD TTL high impedance, automatic positive/negative polarity compatible <b>YP<sub>B</sub>P<sub>R</sub> signal</b> Y: 1.0 V [p-p] including synchronization signal, P <sub>B</sub> P <sub>R</sub> : 0.7 V [p-p] 75 Ω
<MONITOR OUT> terminal	1 set, high-density D-Sub 15 p (female) <b>RGB signal</b> 0.7 V [p-p] 75 Ω (SYNC ON GREEN: 1.0 V [p-p] 75 Ω) SYNC/HD TTL high impedance, positive/negative polarity VD TTL high impedance, positive/negative polarity <b>YP<sub>B</sub>P<sub>R</sub> signal</b> Y: 1.0 V [p-p] including synchronization signal, P <sub>B</sub> P <sub>R</sub> : 0.7 V [p-p] 75 Ω
<HDMI 1 IN> terminal <HDMI 2 IN> terminal	Total 2 sets, HDMI 19 p, HDCP compatible, Deep Color compatible <b>Audio signal</b> Linear PCM (sampling frequency: 48 kHz/44.1 kHz/32 kHz)
<VIDEO IN> terminal	1 set, pin jack, 1.0 V [p-p] 75 Ω
<AUDIO IN 1> terminal <AUDIO IN 2> terminal	Total 2 sets, M3 stereo mini jack, 0.5 V [rms], input impedance 22 kΩ or more
<AUDIO IN 3> terminal	1 set, pin jack x 2 (L-R), 0.5 V [rms], input impedance 22 kΩ or more
<VARIABLE AUDIO OUT> terminal	1 set, M3 stereo mini jack (monitor output, stereo compatible), 0 V [rms] to 2.0 V [rms] (variable), output impedance 2.2 kΩ or lower
<SERIAL IN> terminal	D-Sub 9 p, 1 set, RS-232C compliant, for computer control
<REMOTE 1 IN> terminal	1 set, D-Sub 9 p, for contact control
<REMOTE 2 IN> terminal	1 set, M3 stereo mini jack, for remote control (wired)
<DIGITAL LINK/LAN> terminal	1 set, RJ-45, for network and DIGITAL LINK connections (HDBaseT™ compliant), PLink compatible, 100Base-TX, HDCP compatible, Deep Color compatible
<LAN> terminal	1 set, RJ-45, for network connection, PLink compatible, 10Base-T/100Base-TX
<VIEWER/PAIRING> terminal	1 set, USB connector (type A), for Memory Viewer function/pairing function
<DC OUT> terminal	USB connector (type A) x 1, for power supply (DC 5 V, maximum 2 A)

■ Wireless LAN

To use the wireless LAN function with the projector, it is necessary to attach the optional Wireless Module (Model No.: ET-WM300).

<b>Compliance standards</b>	IEEE802.11a/b/g/n		
<b>Transmission method</b>	DSSS, OFDM		
<b>Modulation method</b>	DBPSK, DQPSK, CCK, BPSK, QPSK, 16QAM, 64QAM, MIMO		
<b>Transmission speed</b>	IEEE802.11b	Maximum 11 Mbps	
	IEEE802.11g/a	Maximum 54 Mbps	
	IEEE802.11n	Maximum 300 Mbps	
<b>Communication distance</b>	Approx. 30 m (98'5") (depending on the operating environment)		
<b>Frequency band (center frequency)</b>	<b>When MIRRORING input is selected</b>		
	PT-MZ670, PT-MZ670L, PT-MW630, PT-MW630L, PT-MZ570, PT-MZ570L, PT-MW530, PT-MW530L	IEEE802.11b/g/n	2.412 GHz - 2.462 GHz
		IEEE802.11a/n	5.180 GHz - 5.240 GHz (W52)
	PT-MZ670A, PT-MZ670LA, PT-MW630A, PT-MW630LA, PT-MZ570A, PT-MZ570LA, PT-MW530A, PT-MW530LA	IEEE802.11b/g/n	2.412 GHz - 2.462 GHz
		IEEE802.11a/n	5.745 GHz - 5.805 GHz (W58: excluding ch 165 )
	PT-MZ670D, PT-MW630D, PT-MZ570D, PT-MW530D	IEEE802.11b/g/n	2.412 GHz - 2.462 GHz
		IEEE802.11a/n	5.180 GHz - 5.240 GHz (W52) 5.745 GHz - 5.805 GHz (W58: excluding ch 165)
	<b>When [WIRELESS LAN] is set to [SIMPLE]</b>		
	All models	IEEE802.11b/g/n	2.412 GHz - 2.462 GHz
	<b>When [WIRELESS LAN] is set to [M-DIRECT]</b>		
	PT-MZ670, PT-MZ670L, PT-MW630, PT-MW630L, PT-MZ570, PT-MZ570L, PT-MW530, PT-MW530L	IEEE802.11b/g/n	2.412 GHz - 2.462 GHz
		IEEE802.11a/n	5.180 GHz - 5.240 GHz (W52)
	PT-MZ670A, PT-MZ670LA, PT-MW630A, PT-MW630LA, PT-MZ570A, PT-MZ570LA, PT-MW530A, PT-MW530LA	IEEE802.11b/g/n	2.412 GHz - 2.462 GHz
		IEEE802.11a/n	5.745 GHz - 5.805 GHz (W58: excluding ch 165)
	PT-MZ670D, PT-MW630D, PT-MZ570D, PT-MW530D	IEEE802.11b/g/n	2.412 GHz - 2.472 GHz
		IEEE802.11a/n	5.180 GHz - 5.240 GHz (W52) 5.745 GHz - 5.825 GHz (W58)
	<b>When [WIRELESS LAN] is set to [USER]</b>		
	PT-MZ670, PT-MZ670L, PT-MW630, PT-MW630L, PT-MZ570, PT-MZ570L, PT-MW530, PT-MW530L	IEEE802.11b/g/n	2.412 GHz - 2.462 GHz
		IEEE802.11a/n	5.180 GHz - 5.240 GHz (W52)
			5.260 GHz - 5.320 GHz (W53) 5.660 GHz - 5.700 GHz
	PT-MZ670A, PT-MZ670LA, PT-MW630A, PT-MW630LA, PT-MZ570A, PT-MZ570LA, PT-MW530A, PT-MW530LA	IEEE802.11b/g/n	2.412 GHz - 2.462 GHz
		IEEE802.11a/n	5.745 - 5.805 GHz (W58: excluding ch 165) • for Taiwan
5.280 GHz - 5.320 GHz (W53: excluding ch 52)			
5.745 GHz - 5.805 GHz (W58: excluding ch 165)			
PT-MZ670D, PT-MW630D, PT-MZ570D, PT-MW530D	IEEE802.11b/g/n	2.412 GHz - 2.472 GHz	
	IEEE802.11a/n	5.180 GHz - 5.240 GHz (W52)	
		5.260 GHz - 5.320 GHz (W53)	
5.745 GHz - 5.825 GHz (W58)			

Chapter 7 Appendix — Specifications

Channels used	<b>When MIRRORING input is selected</b>		
	PT-MZ670, PT-MZ670L, PT-MW630, PT-MW630L, PT-MZ570, PT-MZ570L, PT-MW530, PT-MW530L	IEEE802.11b/g/n	Channels 1 to 11
		IEEE802.11a/n	Channels 36/40/44/48 (W52)
	PT-MZ670A, PT-MZ670LA, PT-MW630A, PT-MW630LA, PT-MZ570A, PT-MZ570LA, PT-MW530A, PT-MW530LA	IEEE802.11b/g/n	Channels 1 to 11
		IEEE802.11a/n	Channels 149/153/157/161 (W58: excluding ch 165)
	PT-MZ670D, PT-MW630D, PT-MZ570D, PT-MW530D	IEEE802.11b/g/n	Channels 1 to 11
		IEEE802.11a/n	Channels 36/40/44/48 (W52) Channels 149/153/157/161 (W58: excluding ch 165)
	<b>When [WIRELESS LAN] is set to [SIMPLE]</b>		
	All models	IEEE802.11b/g/n	Channels 1/6/11
	<b>When [WIRELESS LAN] is set to [M-DIRECT]</b>		
	PT-MZ670, PT-MZ670L, PT-MW630, PT-MW630L, PT-MZ570, PT-MZ570L, PT-MW530, PT-MW530L	IEEE802.11b/g/n	Channels 1 to 11
		IEEE802.11a/n	Channels 36/40/44/48 (W52)
	PT-MZ670A, PT-MZ670LA, PT-MW630A, PT-MW630LA, PT-MZ570A, PT-MZ570LA, PT-MW530A, PT-MW530LA	IEEE802.11b/g/n	Channels 1 to 11
		IEEE802.11a/n	Channels 149/153/157/161 (W58: excluding ch 165)
	PT-MZ670D, PT-MW630D, PT-MZ570D, PT-MW530D	IEEE802.11b/g/n	Channels 1 to 13
		IEEE802.11a/n	Channels 36/40/44/48 (W52) Channels 149/153/157/161/165 (W58)
<b>When [WIRELESS LAN] is set to [USER]</b>			
PT-MZ670, PT-MZ670L, PT-MW630, PT-MW630L, PT-MZ570, PT-MZ570L, PT-MW530, PT-MW530L	IEEE802.11b/g/n	Channels 1 to 11	
	IEEE802.11a/n	Channels 36/40/44/48 (W52) Channels 52/56/60/64 (W53) Channels 132/136/140 (part of W56)	
PT-MZ670A, PT-MZ670LA, PT-MW630A, PT-MW630LA, PT-MZ570A, PT-MZ570LA, PT-MW530A, PT-MW530LA	IEEE802.11b/g/n	Channels 1 to 11	
	IEEE802.11a/n	Channels 149/153/157/161 (W58: excluding ch 165) • for Taiwan Channels 56/60/64 (W53: excluding ch 52) Channels 149/153/157/161 (W58: excluding ch 165)	
PT-MZ670D, PT-MW630D, PT-MZ570D, PT-MW530D	IEEE802.11b/g/n	Channels 1 to 13	
	IEEE802.11a/n	Channels 36/40/44/48 (W52) Channels 52/56/60/64 (W53) Channels 149/153/157/161/165 (W58)	
Security	When connected in infrastructure mode 128 bits/64 bits WEP, WPA-PSK <TKIP/AES>, WPA2-PSK <TKIP/AES>, WPA-EAP/WPA2-EAP <PEAP (MS-CHAPv2)/PEAP (GTC)/EAP-TTLS (MD5) / EAP-TTLS (MS-CHAPv2)/EAP-FAST (MS-CHAPv2)/EAP-FAST (GTC)>		

## ■ Compatible signal

For details of the types of video signals that can be used with the projector, refer to “List of compatible signals” (➔ page 217).

<b>Video input</b>
Horizontal: 15.73 kHz, Vertical: 59.94 Hz; Horizontal: 15.63 kHz, Vertical: 50 Hz
<b>RGB input</b>
<ul style="list-style-type: none"> <li>• Resolution: 640 x 400 to 1 920 x 1 200</li> <li>• Dot clock frequency: 162 MHz or less</li> <li>• PIAS (Panasonic Intelligent Auto Scanning) system</li> </ul>
<b>Y<sub>C</sub>C<sub>R</sub>/Y<sub>P</sub>P<sub>R</sub> input</b>
<ul style="list-style-type: none"> <li>• Resolution: 480i/576i to 1 920 x 1 080</li> <li>• Dot clock frequency: 148.5 MHz or less</li> <li>• The SYNC/HD and VD terminals do not support 3 value SYNC.</li> </ul>
<b>HDMI input</b>
<ul style="list-style-type: none"> <li>• Moving image signal resolution: 480i<sup>*1</sup>/576i<sup>*1</sup> to 1 920 x 1 080</li> <li>• Still image signal resolution: 640 x 400 to 1 920 x 1 200 (non-interlace)</li> <li>• Dot clock frequency: 25 MHz to 162 MHz</li> </ul>

\*1 Pixel-Repetition signal (dot clock frequency 27.0 MHz) only

### Note

- DIGITAL LINK input compatible signal is the same as HDMI input compatible signal.

# Dimensions

Unit: mm

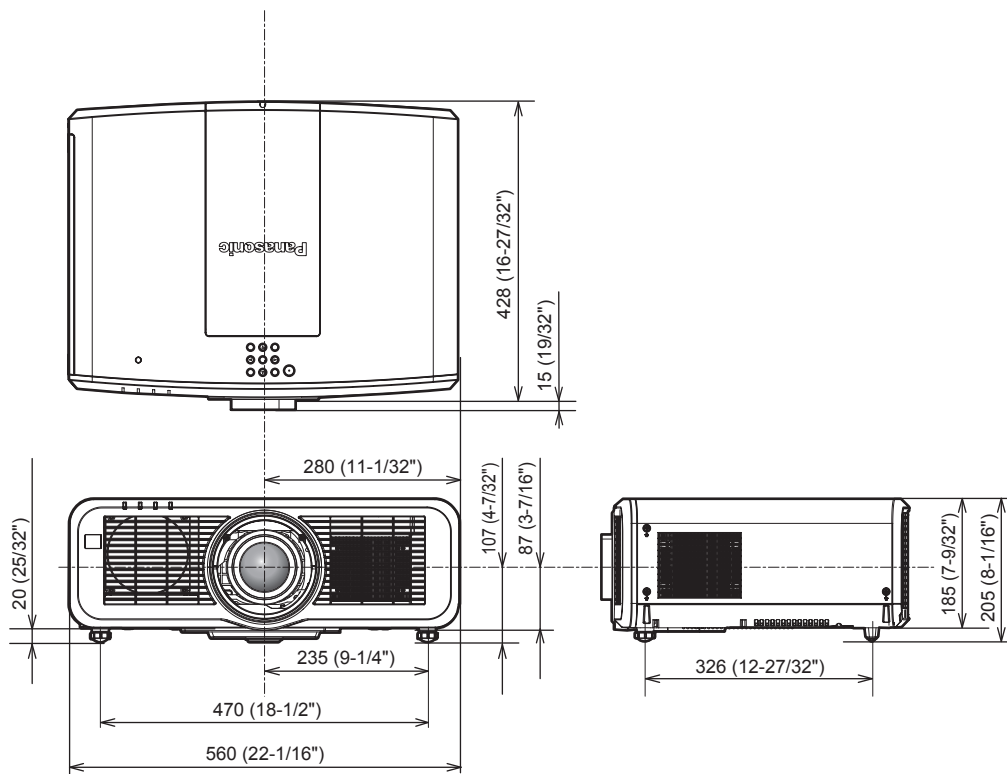

- \* The above dimensions are obtained when the standard zoom lens is attached.
- \* Actual dimensions may differ depending on the product.



## Precautions for attaching the Ceiling Mount Bracket

- When installing the projector to a ceiling, use the Ceiling Mount Bracket (Model No.: ET-PKD120H (for High Ceilings), ET-PKD120S (for Low Ceilings)) together with Ceiling Mount Bracket (Model No.: ET-PKE301B (Projector Mount Bracket)).

**Model No.: ET-PKD120H (for High Ceilings), ET-PKD120S (for Low Ceilings), ET-PKE301B (Projector Mount Bracket)**

- Attach the drop-prevention set that comes with the Ceiling Mount Bracket to the projector. If you need the drop-prevention set (Service Model No.: DPPW1004ZA/X1) is necessary, consult your dealer.
- When the projector is mounted to the existing Ceiling Mount Bracket (in combination with the Model No.: ET-PKD120H (for High Ceilings) or ET-PKD120S (for Low Ceilings), and the Model No.: ET-PKE300B (Projector Mount Bracket)), it is necessary to replace the drop-prevention wire rope with the one corresponding to this projector. Consult your dealer.

**Drop-prevention set (service model no.: DPPW1004ZA/X1)**

- Ask a qualified technician to do the installation work such as mounting the projector on the ceiling.
- Panasonic takes no responsibility for any damage to the projector resulting from use of the Ceiling Mount Bracket not manufactured by Panasonic or the inappropriate choice of location for installing the Ceiling Mount Bracket, even if the warranty period of the projector has not expired.
- Unused products must be removed promptly by a qualified technician.
- Use a torque screwdriver or Allen torque wrench to tighten bolts to their specified tightening torques. Do not use electric screwdrivers or impact screwdrivers.
- Read the Installation Instructions of the Ceiling Mount Bracket for details.
- The model numbers of accessories and optional accessories are subject to change without prior notice.

### ■ Specification for the screw holes to fix the projector (projector bottom view)

Unit: mm

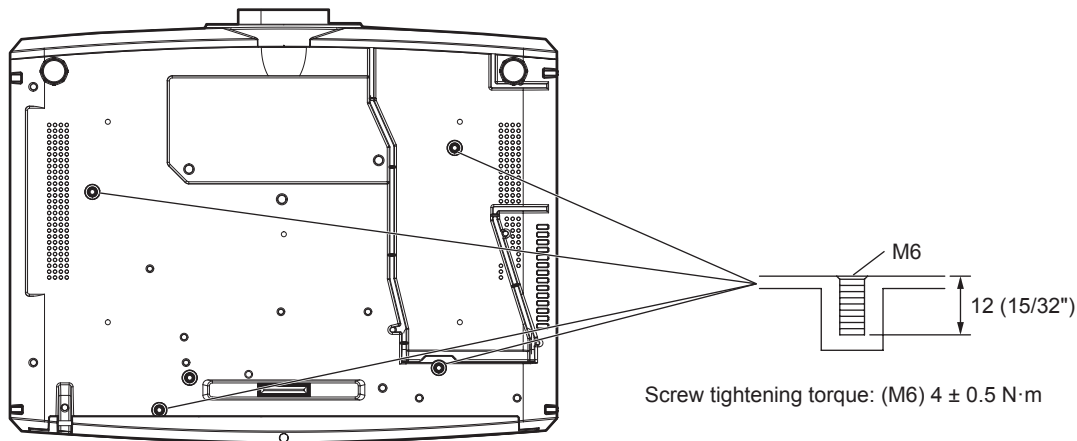

# Index

- A**
- Accessories ..... 26
  - <AC IN> terminal ..... 30, 57
  - Adjusting adjustable feet ..... 47
  - [ADVANCED MENU] ..... 81, 95
  - Air filter unit ..... 198
  - Application software ..... 24
  - [ASPECT] ..... 89
  - <ASPECT> button
    - Remote control ..... 28, 75
  - Aspect function ..... 75
  - [AUDIO SETTING] ..... 122
  - Automatic setup function ..... 73
  - [AUTO SETUP] ..... 100
  - <AUTO SETUP/CANCEL> button
    - Remote control ..... 28, 73
  - [AUTO SIGNAL] ..... 100
- B**
- [BACK COLOR] ..... 108
  - [BLANKING] ..... 95
  - [BRIGHTNESS] ..... 84
- C**
- Cautions on use ..... 25
  - Cautions when installing ..... 19
  - Cautions when transporting ..... 19
  - Ceiling Mount Bracket ..... 225
  - [CLAMP POSITION] ..... 96
  - [CLOCK PHASE] ..... 91
  - [CLOSED CAPTION SETTING] ..... 107
  - [COLOR] ..... 85
  - [COLOR ADJUSTMENT] ..... 99
  - [COLOR CORRECTION] ..... 99
  - [COLOR TEMPERATURE] ..... 85
  - Connecting the power cord ..... 57
  - Connecting the remote control to the projector with a cable ..... 33
  - Connecting with the wireless LAN ..... 156
  - Connection ..... 51
  - [CONTRAST] ..... 84
  - [CONTROL DEVICE PASSWORD CHANGE] ..... 138
  - [CONTROL DEVICE SETUP] ..... 137
  - [Crestron Connected(TM)] ..... 175
- D**
- [DATA CLONING] ..... 126
  - [DATE AND TIME] ..... 117
  - [DAYLIGHT VIEW] ..... 87
  - [DC OUT] ..... 125
  - <DEFAULT> button
    - Remote control ..... 28, 80
  - Deleting the registered signal ..... 132
  - [DIGITAL CINEMA REALITY] ..... 95
  - DIGITAL LINK ..... 24
  - <DIGITAL LINK> button
    - Remote control ..... 28, 66
  - [DIGITAL LINK IN] ..... 103
  - [DIGITAL LINK MENU] ..... 140
  - [DIGITAL LINK MODE] ..... 139
  - [DIGITAL LINK STATUS] ..... 139
  - [DIGITAL ZOOM] ..... 110
  - Dimensions ..... 224
  - Display language ..... 82, 98
  - [DISPLAY OPTION] ..... 82, 99
  - [DISPLAY SETTING] ..... 135
  - Disposal ..... 24
  - [DYNAMIC CONTRAST] ..... 88
  - <D.ZOOM-> button
    - Remote control ..... 28, 74
  - <D.ZOOM+> button
    - Remote control ..... 28, 74
- E**
- <ECO> button
    - Remote control ..... 28, 76
  - [ECO MANAGEMENT] ..... 113
  - <ENTER> button
    - Projector body ..... 31
    - Remote control ..... 28, 79
  - Expanding signal lock-in range ..... 133
- F**
- FAQ ..... 204
  - [FILTER COUNTER] ..... 124
  - Filter indicator ..... 196
  - <FOCUS> button
    - Remote control ..... 28, 67
  - [FREEZE] ..... 110
- <FREEZE> button
  - Remote control ..... 28, 72
- Freeze function ..... 72
- Function button ..... 75
- <FUNCTION> button
  - Remote control ..... 28, 75
- [FUNCTION BUTTON] ..... 121
- G**
- [GAMMA] ..... 86
- H**
- <HDMI 1> button
    - Remote control ..... 28, 66
  - <HDMI 2> button
    - Remote control ..... 28, 66
  - [HDMI IN] ..... 102
- I**
- <ID ALL> button
    - Remote control ..... 28, 76
  - <ID SET> button
    - Remote control ..... 28, 76
  - [INITIALIZE] ..... 129
  - Initial setting ..... 60
  - [INITIAL STARTUP] ..... 116
  - [INPUT RESOLUTION] ..... 96
  - <INPUT SELECT> button
    - Projector body ..... 31, 67
    - Installation mode ..... 35
- L**
- [LENS CALIBRATION] ..... 121
  - <LENS/CANCEL> button
    - Projector body ..... 31, 67
  - [LightID] ..... 115
  - Light source indicator ..... 196
  - List of compatible signals ..... 217
  - [LOAD ALL USER DATA] ..... 129
- M**
- Main menu ..... 80
  - Main power switch ..... 30, 59
  - Maintenance ..... 198
  - [MEMORY VIEWER] ..... 145
  - MEMORY VIEWER input ..... 185
  - <MENU> button
    - Projector body ..... 31, 79
    - Remote control ..... 28, 79
  - Menu item ..... 81
  - [MENU LOCK] ..... 136
  - [MENU LOCK PASSWORD] ..... 136
  - [MIRRORING] ..... 149
  - MIRRORING input ..... 181
  - <MUTE> button
    - Remote control ..... 28, 71
- N**
- Navigating through the menu ..... 79
  - Network connection ..... 153
  - [NETWORK CONTROL] ..... 145
  - [NETWORK STATUS] ..... 150
  - [NETWORK/USB] ..... 83, 139
  - <NETWORK/USB> button
    - Remote control ..... 28, 66
  - [NOISE REDUCTION] ..... 87
- O**
- <ON SCREEN> button
    - Remote control ..... 28, 72
  - [ON-SCREEN DISPLAY] ..... 104
  - On-screen menu ..... 79
  - Optional accessories ..... 27
- P**
- Pairing function ..... 193
  - [Panasonic APPLICATION] ..... 147
  - Panasonic APPLICATION input ..... 178
  - [PICTURE] ..... 81, 84
  - [PICTURE MODE] ..... 84
  - [POSITION] ..... 81, 89
  - Power button
    - Projector body ..... 31
    - Remote control ..... 28
  - Power cord ..... 57
  - Power indicator ..... 58
  - Precautions for attaching the Ceiling Mount Bracket ..... 225
  - Precautions for use ..... 19
- Projecting ..... 66
- [PROJECTION METHOD] ..... 112
- Projector body ..... 30
- [PROJECTOR ID] ..... 112
- [PROJECTOR NAME] ..... 145
- [PROJECTOR SETUP] ..... 82, 112
- Protecting the registered signal ..... 133
- [P-TIMER] ..... 109
- <P-TIMER> button
  - Remote control ..... 28, 75
- R**
- [RASTER POSITION] ..... 97
  - Read this first! ..... 5
  - [REALTIME KEYSTONE] ..... 91
  - Registering new signals ..... 132
  - <REMOTE 1 IN> terminal ..... 216
  - [REMOTE1 MODE] ..... 121
  - <REMOTE 2 IN> terminal ..... 33
  - Remote control ..... 28
  - Remote control operations ..... 71
  - Removing/attaching the projection lens ..... 48
  - Renaming the registered signal ..... 132
  - Replacing the air filter unit ..... 200
  - Replacing the unit ..... 200
  - Resetting to the factory default ..... 80
  - <RETURN> button
    - Remote control ..... 28
  - <RGB1/2> button
    - Remote control ..... 28, 66
  - [RGB IN] ..... 101
  - [RS-232C] ..... 119, 213
- S**
- [SAVE ALL USER DATA] ..... 129
  - [SCHEDULE] ..... 118
  - <SCREEN ADJ> button
    - Remote control ..... 28, 73
  - [SCREEN ADJUSTMENT] ..... 92
  - [SCREEN SETTING] ..... 100
  - Security ..... 22
  - [SECURITY] ..... 83, 135
  - [SECURITY PASSWORD] ..... 135
  - [SECURITY PASSWORD CHANGE] ..... 135
  - Selecting the input signal ..... 66
  - [SELF TEST] display ..... 206
  - <SERIAL IN> terminal ..... 213
  - [SERVICE PASSWORD] ..... 130
  - Setting ID number of the remote control ..... 76
  - Setting up ..... 35
  - [SHARPNESS] ..... 87
  - [SHIFT] ..... 89
  - <SHIFT> button
    - Remote control ..... 28, 67
  - <SHUTTER> button
    - Projector body ..... 31
    - Remote control ..... 28, 71
  - [SHUTTER SETTING] ..... 108
  - [SIGNAL LIST] ..... 83, 132
  - [SIGNAL SEARCH] ..... 107
  - Specifications ..... 219
  - [STARTUP INPUT SELECT] ..... 116
  - [STARTUP LOGO] ..... 108
  - [STATUS] ..... 125
  - <STATUS> button
    - Remote control ..... 28, 76
  - Sub memory ..... 134
  - Switching off the projector ..... 65
  - Switching on the projector ..... 59
  - [SYSTEM SELECTOR] ..... 88
- T**
- Temperature indicator ..... 196
  - [TEST PATTERN] ..... 83, 131
  - <TEST PATTERN> button
    - Remote control ..... 28, 75
  - [TEXT CHANGE] ..... 136
  - [TINT] ..... 85
  - Troubleshooting ..... 202
- V**
- <VIDEO> button
    - Remote control ..... 28, 66
  - Volume adjustment ..... 72
  - <VOL->/<VOL+> button
    - Projector body ..... 31
    - Remote control ..... 28, 72

## Index

---

### W

Web control .....	158
[WIRED LAN] .....	140
[WIRELESS LAN] .....	141
Wireless Module .....	50

### Z

[ZOOM] .....	90
<ZOOM> button	
Remote control .....	28, 67

## Disposal of Old Equipment and Batteries Only for European Union and countries with recycling systems



These symbols on the products, packaging, and/or accompanying documents mean that used electrical and electronic products and batteries must not be mixed with general household waste. For proper treatment, recovery and recycling of old products and used batteries, please take them to applicable collection points in accordance with your national legislation.



By disposing of them correctly, you will help to save valuable resources and prevent any potential negative effects on human health and the environment. For more information about collection and recycling, please contact your local municipality. Penalties may be applicable for incorrect disposal of this waste, in accordance with national legislation.



EU

### Note for the battery symbol (bottom symbol)

This symbol might be used in combination with a chemical symbol. In this case it complies with the requirement set by the Directive for the chemical involved.

## Information on Disposal in other Countries outside the European Union

These symbols are only valid in the European Union.

If you wish to discard these items, please contact your local authorities or dealer and ask for the correct method of disposal.

## Product Information (for Turkey only)



AEEE Yönetmeliğine Uygundur.

Eski Ekipman ve Bataryaların İşlenmesi.

Sadece geri dönüşüm sistemleri olan Avrupa Birliği ve ülkeleri için geçerlidir.



Ürünler, ambalaj ve/veya ekli belgeler üzerindeki bu semboller kullanılmış elektrik ve elektronik ürünlerin ve pillerin genel ev atığı ile karıştırılmaması gerektiğini ifade eder.

Eski ürünlerin ve pillerin toplanması ve geri kazanılması için bu atıkları lütfen yasayla belirlenmiş olan uygun toplama merkezlerine teslim ediniz.

Bu atıkların doğru işlenmesiyle, değerli kaynakların korunmasına ve insan sağlığı ve çevreye olası negatif etkilerinin engellenmesine yardımcı olabilirsiniz.



Atıkların toplanması ve geri dönüşümü için detaylı bilgi için lütfen bağlı olduğunuz yerel yönetimlerle iletişime geçiniz.

Atıkların atılmasıyla ilgili yanlış uygulamalar yasayla belirlenmiş olan cezalara sebebiyet verebilir.

# Panasonic Corporation

Web Site : <https://panasonic.net/cns/projector/>

© Panasonic Corporation 2017

## Panasonic System Communications Company of North America

5th Floor, Two Riverfront Plaza, Newark, NJ 07102-5490

TEL: (877) 803 - 8492

## Panasonic Canada Inc.

5770 Ambler Drive, Mississauga, Ontario L4W 2T3

TEL: (905) 624 - 5010