



Owner's Manual

Network Set-up and Operation

Wired Setting

Projector Set-up and Operation

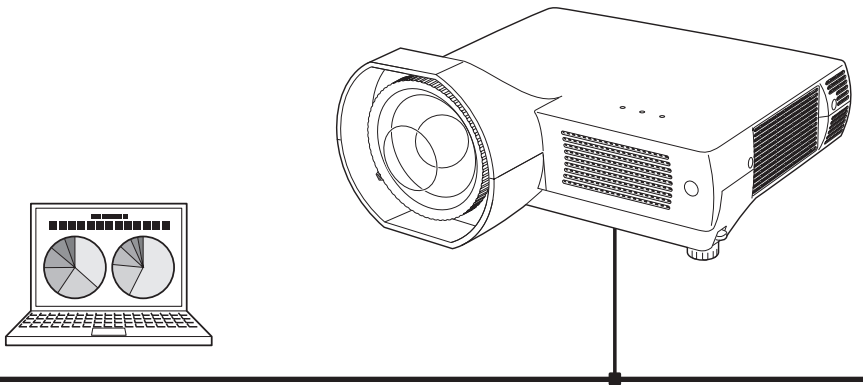

This is the manual for the Network function.

Read this manual thoroughly to operate the Network function.

First, read the owner's manual of the projector to understand the basic operation of the projector and the safety instructions.

The safety instructions in the owner's manuals should be followed strictly.

Compliance

Federal Communications Commission Notice

This equipment has been tested and found to comply with the limits for a Class B digital device, pursuant to part 15 of the FCC Rules. These limits are designed to provide reasonable protection against harmful interference in a residential installation. This equipment generates, uses and can radiate radio frequency energy and, if not installed and used in accordance with the instructions, may cause harmful interference to radio communications. However, there is no guarantee that interference will not occur in a particular installation. If this equipment does cause harmful interference to radio or television reception, which can be determined by turning the equipment off and on, the user is encouraged to try to correct the interference by one or more of the following measures:

- Reorient or relocate the receiving antenna.
- Increase the separation between the equipment and receiver.
- Connect the equipment into an outlet on a circuit different from that to which the receiver is connected.
- Consult the dealer or an experienced radio/TV technician for help.

Use of shielded cable is required to comply with class B limits in Subpart B of Part 15 of FCC Rules.

Do not make any changes or modifications to the equipment unless otherwise specified in the instructions. If such changes or modifications should be made, you could be required to stop operation of the equipment.

Model Number	: PLC-WXE45
Trade Name	: Sanyo
Responsible party	: SANYO FISHER COMPANY
Address	: 21605 Plummer Street, Chatsworth, California 91311
Telephone No.	: (818)998-7322



The CE Mark is a Directive conformity mark of the European Community (EC).

Safety instructions



CAUTION IN USING THE PROJECTOR VIA NETWORKS

- When you find a problem with the projector, remove the power cable immediately and inspect the unit. Using the projector with failure may cause fire or other accidents.
- If you remotely use the projector via networks, carry out a safety check regularly and take particular care to its environment. Incorrect installation may cause fire or other accidents.



CAUTION IN USING NETWORK FUNCTION

- SANYO Electric Co., Ltd. assumes no responsibility for the loss or damage of data, or damage of the computer caused by using this projector. Making back-up copies of valuable data in your computer is recommended.

Trademarks and Copyright

- Microsoft, Windows, and Internet Explorer are either registered trademarks or trademarks of Microsoft Corporation in the United States and/or other countries.
- Netscape Navigator and Netscape Communicator are registered trademarks or trademarks of Netscape Communications Corporation in the United States and other countries.
- Pentium is a registered trademark of Intel Corp. in the United States.
- Macintosh is a registered trademark of Apple, Inc. in the USA and other countries.
- PowerPC is a registered trademark of IBM Corporation.
- Intel Core is a registered trademark of Intel Corporation in the USA and other countries.
- Each name of corporation or product in this Owner's Manual is either a registered trademark or a trademark of its respective corporation.

Notes

- The contents of this manual are subject to change without notice.
- You may not copy the printed materials accompanying with the software.
- We shall not be responsible for any damages caused by reliance on this manual.

Expression/Abbreviation

The OS of the computer and the Web browser described in this manual is Windows XP Professional and Internet Explorer 6.0. In case of another OS or Web browser, some instruction procedures may differ from the actual operation depending on your computer environment.

Use of this manual

This manual does not provide the description of basic operation and functions for computer, web browser, projector and network. For instructions about each piece of equipment or application software, please refer to the respective manual.

Table of contents

Compliance	2
Safety instructions	3
Table of contents	4
1. Preparation	5
LAN functions and the features	6
Required operating environment for computers	8
Network specifications of the projector	8
2. Wired LAN configurations	9
Connecting to the LAN line	10
Network environment settings	10
Network PIN code	12
Network information	12
Wired factory default	13
Wired LAN factory default settings	13
3. Basic setting and operation	15
Starting up the Browser	16
How to use the setting page	18
Initial setting	20
Network configuration	23
E-mail setting	25
SNMP setting	29
4. Controlling the projector	31
Power control and status check	32
Controls	34
PC adjustment	38
Setting up the projector	39
Timer setting	42
Projector information	45
Multi-control	47
5. Appendix	53
Use of telnet	54
Web browser setting	56
Troubleshooting	62
Terminology	63

Chapter 1

1. Preparation

This chapter describes LAN function, features and operating environment for computer.

LAN functions and the features

This product is loaded with a LAN network functions below and you can use the projector under various network environments to meet the wide-ranging needs of the operation.

Web Management function (p.31)

With this function, you can monitor projector functions such as power status, lamp status, input mode, signal condition, lamp-use time, etc. through the network by using the web browser installed on your computer.

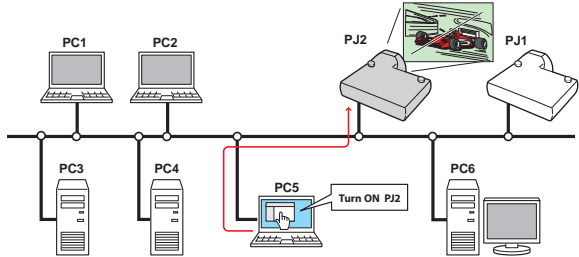

E-Mail Alert function (p.25)

The projector sends messages to the registered e-mail addresses when a lamp abnormality or power failure occurs with the projector. This message describes how to solve the cause of the problems. You can take efficient action for quick recovery.

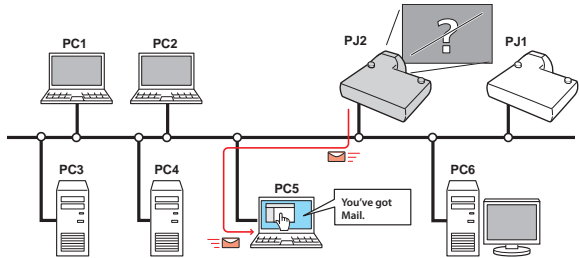

Multi-control function (p.47)

A single computer can control and set up the multiple projectors at the same time.

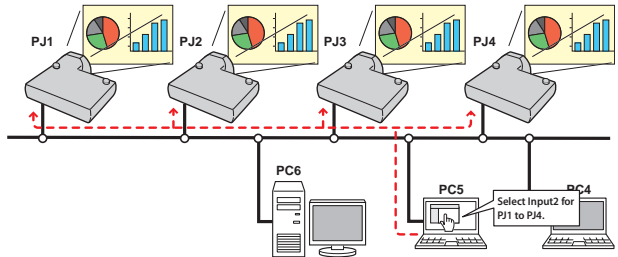

Automatic On/Off using Clock function (☞ p.42)

Automatically turn on or off the projectors at specified date/day and time by using the clock function.

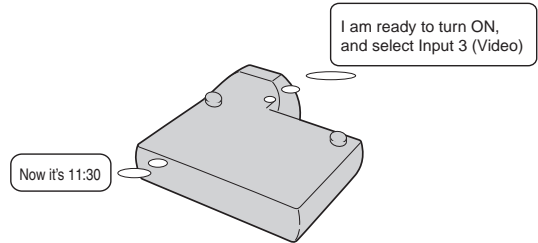

SNMP Agent function (☞ p.29)

To send the information of the projector to the SNMP manager. Enables you to manage the projector condition with the supplied SNMP manager software.

SNMP Manager function (only for Windows)

A function to manage the condition of projectors in the network by using the SNMP protocol. The managing computer needs to provide an SNMP managing software. Refer to the owner's manual of the "PJ Network Manager" supplied separately for further details.

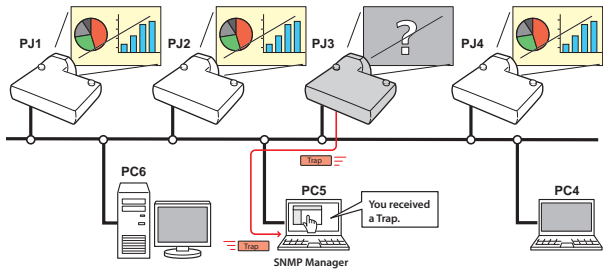

Required operating environment for computers

When operating the projector via the networks, computers should meet the operating environment below.

OS	Windows	Microsoft Windows 2000 or Microsoft Windows XP or Microsoft Windows Vista (32bit version)
	Macintosh	MAC OS X v 10.4 or later
CPU	Windows	Pentium 3 ; 1GHz or higher (more than 2GHz is recommended) for Windows 2000 or Windows XP Pentium 4 ; 3GHz or higher for Windows Vista
	Macintosh	800 MHz PowerPC G4 or faster, or 1.8 GHz Intel Core processor or faster
Memory	Windows	256MB or more for Windows 2000 or Windows XP 1GB or more for Windows Vista
	Macintosh	256MB or more (512MB is recommended)
Free HDD Space		100MB
Screen Resolution		Required to support any of VGA (640 x 480), SVGA (800 x 600), XGA (1024 x 768), The color number should be either 16 bit (65536 colors) or 24/32 bit (16.77 million colors).
Communication Protocol		TCP/IP
Network Correspond	Wired LAN	Correspond to 100BASE-TX (100Mbps) /10BASE-T (10Mbps)
Browser Application	Windows	Microsoft Internet Explorer Ver.4.0 or later Netscape Communications Netscape Communicator Ver.6.0 or later
	Macintosh	Safari 3.0 or later

Network specifications of the projector

LAN Terminal

Data communication speed	100Base-TX (100Mbps)/10Base-T (10Mbps)
Protocol	TCP/IP

2. Wired LAN configurations

This chapter describes the preparation for Wired LAN setting with projectors and how to set the LAN environment.

Setting procedures and contents differ depending on the LAN installation location. When installing, consult your system administrator to set up the LAN appropriately.

Connecting to the LAN line

Connect the LAN cable to the LAN connection terminal of the projector.

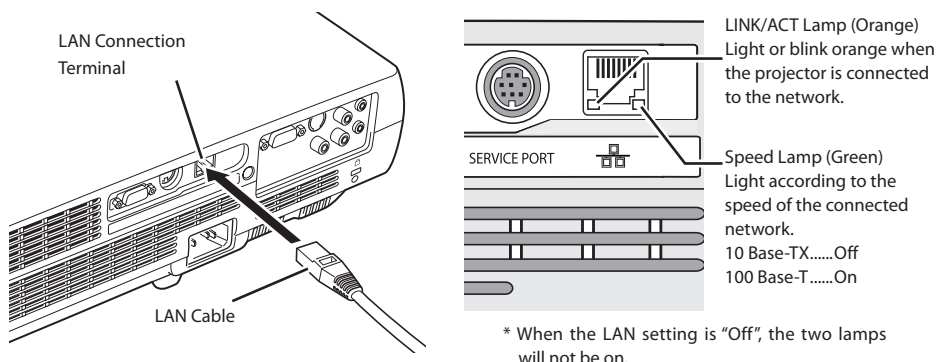

Network environment settings

Set the Wired LAN network through the projector menu.

Detailed network settings will be made with browser. Refer to "3. Basic setting and operation" (p15-30).

First, complete the settings described in this chapter before performing steps in "3. Basic setting and operation."

Setting Procedure

1. Turn on the projector and select "Wired" from the menu bar of the projector.
The projector's LINK/ACT Lamp will be on or blink. If the "Wired setting" is "Off", it will not be on. Follow step 2 and 3 to blink the lamp.
2. Select "Wired Setting" in the projector menu, and press **SELECT** button.
Select similar LAN environment among LAN1, 2 and 3 with the Point ◀ ▶ buttons. (LAN1, 2, and 3 are the factory default setting environments. You can select three different environment among setting LAN1-3. For each setting, refer to the chart on page 13.)
When selecting "Off" in the "Wired setting", the LAN connection will be cut off. Use the function when disconnecting the projector from the network.
3. Press the Point ◀ ▶ buttons then the "Please wait..." message will appear and switching operation will start. Switching will take a while and after completing the operation, the message will disappear. During the switching period, the projector cannot be operated.

4. Press **SELECT** button.

Wired LAN setting screen will appear and selected LAN settings will be displayed. Adjust each item to the setting environment. Consult your system administrator about the detailed settings.

Adjust the figures with the Point ▲▼ buttons and move among the items with the Point ◀▶ buttons.

5. After completing all the settings, select "Set" and press **SELECT** button. Now, all procedures have been done. To cancel the adjusted settings, select "Cancel" and press **SELECT** button.

You can confirm the LAN settings you have made from "Network Information" (p.12). In such cases that the LAN cannot be connected, see this screen.

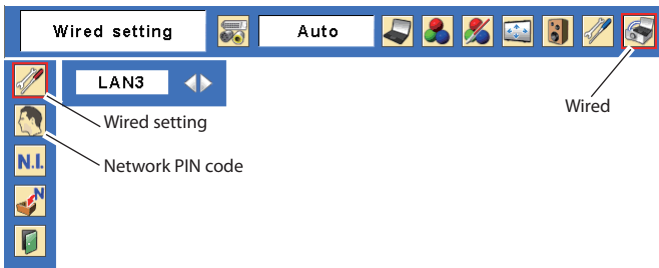

Wired LAN setting screen (Example)

LAN 3	Wired setting			
DHCP	<input type="button" value="Off"/>			
IP address	<input type="text" value="123"/>	<input type="text" value="123"/>	<input type="text" value="123"/>	<input type="text" value="123"/>
Subnet	<input type="text" value="123"/>	<input type="text" value="123"/>	<input type="text" value="123"/>	<input type="text" value="123"/>
Gateway	<input type="text" value="123"/>	<input type="text" value="123"/>	<input type="text" value="123"/>	<input type="text" value="123"/>
DNS	<input type="text" value="123"/>	<input type="text" value="123"/>	<input type="text" value="123"/>	<input type="text" value="123"/>
	<input type="button" value="Set"/>		<input type="button" value="Cancel"/>	

Item	Description
DHCP.....	Sets DHCP function On or Off. When you setup the network setting manually, select "Off". When it set On, IP address, Subnet, Gateway and DNS are automatically set according to your network environment *1.
IP address	Sets IP address of the projector
Subnet.....	Sets Subnet mask. Normally sets 255.255.255.0
Gateway*2.....	Sets IP address of the default gateway (Router)
DNS*3.....	Sets IP address of the DNS server.

*1 Set "On" only when the DHCP server is available on your network environment.

*2 Set [255.255.255.255] if the network does not provide the gateway (router).

*3 Set [255.255.255.255] if you do not use the function E-mail alert.

Network PIN code

The Network PIN code is to restrict the access from the networks to the projector.
After setting the Network PIN code, you need to enter it to operate the projector via the networks.

1. Select Network PIN code menu, and press **SELECT** button.
The Network PIN code screen will appear.
2. Set the Network PIN code.

Set the figures with the Point ▲▼ buttons and move to the next items with the Point ◀▶ buttons. Select "Set" and press **SELECT** button to set. To cancel the preset Network PIN code, select "Cancel". When you do not want to set the Network PIN code, set "0000".

It is recommended to set the Network PIN code if you use the projector via the networks. The Network PIN code can be set also through the networks. See "3. Basic setting and operation" → "Initial setting" → "Network PIN code setting" (☞ p.21).

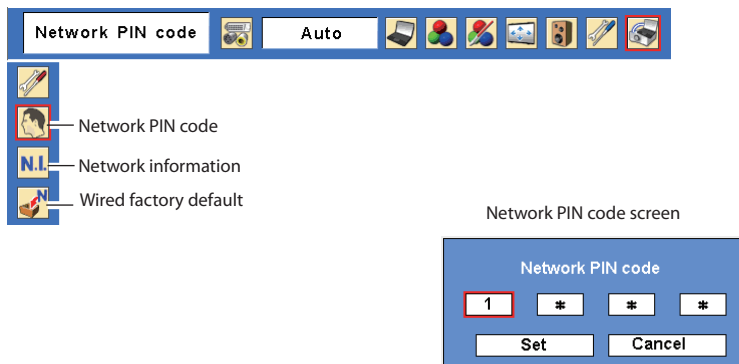

Network information (See the menu above.)

Select Network information from the projector menu and press **SELECT** button to show LAN setting environment of the currently selected projector. (The description below is an example and different from what will be shown.)

Network information	
MAIN PROGRAM:	V1.000
MAC ADDRESS:	08007B650056
IP ADDRESS:	172.021.095.202

Wired factory default (See the menu on the previous page.)

Select "Wired factory default" from the projector menu and press **SELECT** button. All the wired LAN settings will go back to the factory default settings. For details, refer to "Wired LAN factory default settings" as shown below.

Wired LAN factory default settings

Parameter	SELECTED LAN		
	LAN1	LAN2	LAN3
IP ADDRESS	169.254.100.100	192.168.100.100	192.168.100.100
SUBNET MASK	255.255.0.0	255.255.255.0	255.255.255.0
GATEWAY ADDRESS	255.255.255.255	255.255.255.255	255.255.255.255
DNS ADDRESS	255.255.255.255	255.255.255.255	255.255.255.255
IP CONFIGURATION	MANUAL	DHCP	MANUAL

3. Basic setting and operation

Describes basic operation and settings below by using the web browser.

- Initial setting
Setup the basic setting such as Projector name, Network PIN code, Time setting, etc.
- Network setting
Configure Wired LAN environment.
- E-mail Setting
Configure E-mail function to manage the projector.
- SNMP Setting
Configure SNMP function to manage the projector.

Caution: When operating the projector with the browser, connect the projector to the computer with *Wired LAN*. Complete the connection in advance.

Starting up the Browser

1 Enter the IP address

Launch the web browser installed in your computer, enter the IP address into the "Address" on the browser and then press "Enter" key.

Enter the address (192.168.1.201) that you configured in item "Network environment settings" (☞ p.10).

[Note]

For the default IP address for LAN1/LAN2/LAN3, see item "Wired LAN factory default settings" (☞ p.13).

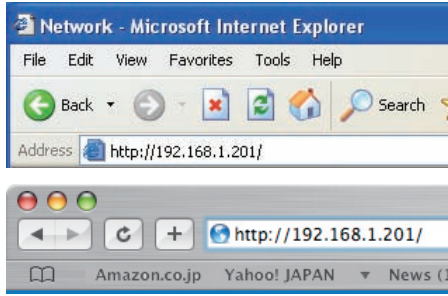

2 Select a display mode and login

This product provides 2 types of control mode, Standard Mode and Light Mode as below. Select a proper mode to match your PC and network environment by clicking on the text link. Once you select your desired display mode, the setting page you selected display mode will be displayed automatically from the next login. To change the display mode, click "Top" on lower-right corner of the setting page (p.17).

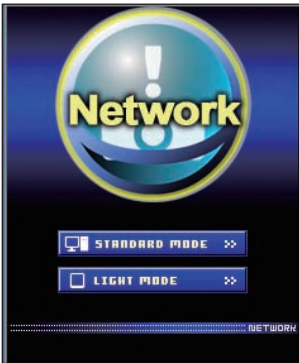

STANDARD MODE

For computer display, displays graphical menus and settings. This mode is recommended for standard use.

LIGHT MODE

Displays with 200 x 300 dots. This mode is optimized for use of the handheld computer, PDA, etc. It is also convenient if the network traffic is heavy. (This mode has some limitations on the network viewer and multi-control functions.)

If the password has been set on the setting page, the authentication window will appear. In that case, type "user" onto the **User Name** text area and the login Network PIN code onto the **Password** text area and then click **OK (Log in)** button.

* The entered User Name must be "user" and it can not be changed.



[Note]

When the projector is accessed for the first time or the Network PIN code "0000" is set, the auto-login is performed and the next main setting page is displayed.



3 Display of main setting page

The following main setting page will be displayed depending on your display mode selection. Perform various kinds of settings through this page. Click on the menus to display the control and setting pages.

1 Main setting page in the Standard Mode display

Clock display
Display on or off by clicking text ON or OFF

Sub menu tab
Switches the sub menu tab.

Page numbers
Switches the pages by clicking the number's tab.

Main menu
For selection of control and setting items of the projector.

Setting page
Displays the control and setting items according to the selected menu.

Returns to Display Mode selection page (p.16)

* To change the screen language, use the initial setting menu (p.20)

This Standard mode display is mainly used through this manual for the setting and control description.

If your computer does not have the Adobe Flash Player version 6 or later, follow the message on the control page to install the Adobe Flash Player. For further product information or installing, see the Adobe homepage.
<http://www.adobe.com>

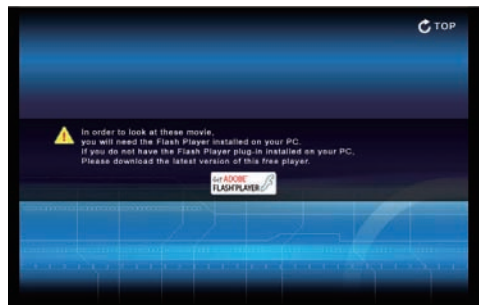

2 Main setting page in the Light Mode display

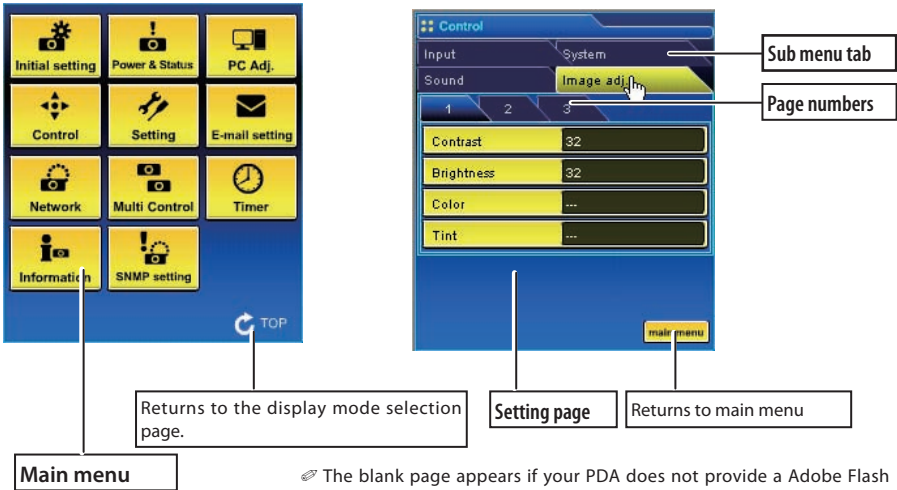

The blank page appears if your PDA does not provide a Adobe Flash Player. You need to install the Adobe Flash Player. (p.17)

How to use the setting page

To control and set up the projector, use the setting menus on the web browser. The basic operation and procedures commonly used on this manual are described below.

Example of the Setting Page

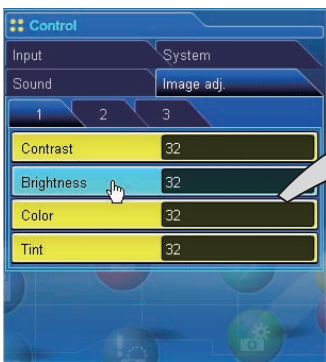

The setting pallet appears after clicking the item. Change the value by clicking ▲ or ▼ button, or type the number onto the text box directly and then click Set button.
* Each item has a valid setting range respectively.

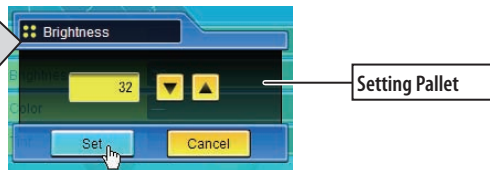

The value in the text box indicates current value.

Each item has a valid setting range. The setting value exceeding its range becomes invalid. Some control items can not be used depending on the selected input mode or functions of the projector you use. In that case, the values of those items are indicated with "---".

Type of the setting pallet

Text box setting

Enter the number or text and then click **Set** button.

or

Change a value with ▲ or ▼ button and then click **Set** button.

The value changes quickly when ▲ or ▼ button is kept pressing.

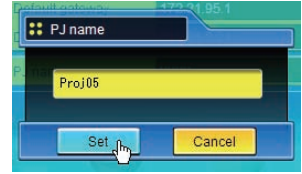

Pull-down menu setting

Select an item with pull-down menu button and then click **Set** button.

or

Select an item by clicking ▲ or ▼ button.

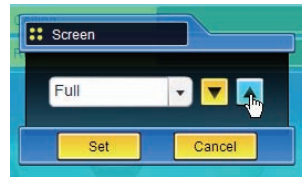

Radio button setting

Select an item by selecting a radio button

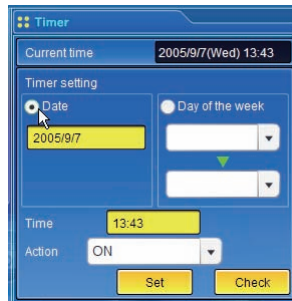

Check box setting

Select items by ticking on check boxes.

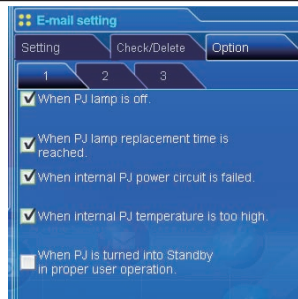



Initial setting

After installing the projector, perform the following basic initial setting.

Click **Initial Setting** on the main menu to display the initial setting page.



Item	Description
Language	Switches display language on the setting page. English or Japanese.
Model name	Indicates the model name of the projector.
Projector name.....	Sets the name of the projector.
Network PIN code	Sets the Network PIN code to login the setting page (p.12)
PLink	Switches PLink password authentication on or off.
Password.....	Password for PLink function

Network PIN code setting

This is to set the Network PIN code to restrict the access from an unauthorized person through the network.

Enter a 4-digit number as the Network PIN code onto the text box and click **Set** button.

The projector's network part begins restarting and it takes about 20 seconds. Close (Quit) the web browser and access to the login page again in 20 seconds. This is to perform the login authentication firmly.

The default Network PIN code as [0000], which means no Network PIN code is set.

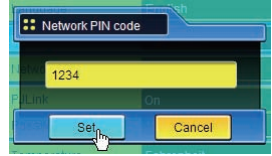

- ☞ When you connect the projector to the network, it is recommended to set a new Network PIN code. Only a four-digit number is valid for the Network PIN code.
- ☞ If you forget the Network PIN code to the projector, you can check it by selecting "Network PIN code" sub menu from "Network" menu on the projector. For further information, please see item "Network PIN code setting" (p.12).

PJLink and password setting

This is to set the PJLink password authentication on or off. If "On" is set with the PJLink pull-down menu, the password must be required. Enter a **password*** onto the text box and click **Set** button.

Refer to the projector owner's manual for further details of the PJLink function.

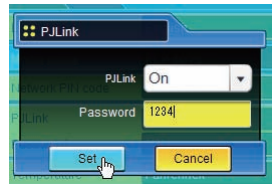

- ☞ 1 to 32 alphanumeric characters can be used for the password.

What's PJLink?

The projectors equipped with PJLink function can be used together on the same network, regardless of model or brand, for centralized control and monitoring. This standard was established by the Japan Business Machine and Information System Industries Association (JBMIA). <http://pjlink.jbmia.or.jp/>

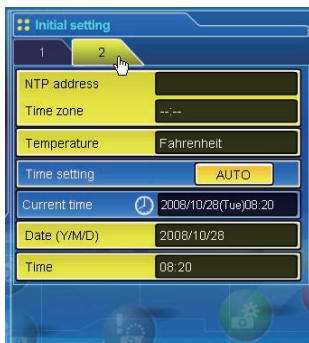

Item	Description
NTP address.....	Enter the address of NTP server. Please consult your network administrator for setting up of the NTP server.
Time zone.....	Sets your country or region's time zone
Temperature.....	Switches display temperature unit Centigrade or Fahrenheit
Time setting.....	When clicking AUTO button, the date and time set on your computer are set to the projector. The timer icon appears when time is set up correctly.
Current time.....	Indicates current date and time set on the projector
Date.....	Sets date in manual
Time.....	Sets time in manual

Date and time setting

NTP is abbreviated expressions of Network Time Protocol. It is a protocol to acquire the exact current time via the network. This projector acquires the current time from the NTP server and update the time in the network module. After setting the NTP address, the projector acquires the time per 24 hours. If the projector fails acquiring the time from the NTP server, the projector tries to acquire the time every 1 hour until it succeeds.

- ☞ "Time zone" is the local time as an offset from Greenwich Mean Time (GMT). "Time zone" is in ± hour:minute format and is available from -23:59 to +23:59.
ex. Time zone: +09:00 in Tokyo, Japan
- ☞ Both of "NTP address" and "Time zone" should be set, otherwise the setting will be failed.

When the NTP address is not set, perform the time setting with "Auto-setting" or "manual setting" described below.

Auto setting

Click **AUTO** button on the page, the date and time set on your computer are set to the projector.

Note: Confirm that your computer has a correct clock time before performing the auto time setting.

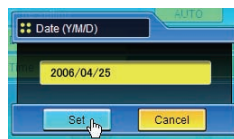

Manual setting

Click the item **Date** or **Time** and enter the date or time on the input box with adequate format.

Date is in year/month/day format.

ex. 2007/10/05

Time is in 24-hour:minute format.

ex. 18:30

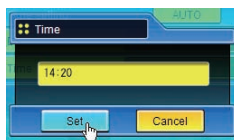

This projector does not provide the built-in battery. The date and time information are lost when the projector turns off (when "Eco" is set for the stand-by mode (Refer to p.40)), or the network configuration is reset, or the wired setting is switched to LAN1/LAN2/LAN3/Off. The timer function is disable until time is set up correctly. When using the NTP address for time setting, the current time is acquired at the projector starting up and the timer function is activated after finishing the time setting correctly.



Network configuration

Click **Network** on the main menu. The following setting page is displayed. Set up the projector's network environment on this **Setting** sub menu.



Setting of LAN

1. Select a type of LAN from **Change setting** pull down menu.

- LAN1
- LAN2
- LAN3

For the default setting of the above LAN, see the item "Wired LAN factory default settings" (p.13).

Item	Description
Change setting.....	Selects LAN1 to LAN3
IP configuration.....	Sets DHCP or Manual
IP address	Sets IP address of the projector
Subnet mask.....	Sets Subnet mask.
Default gateway*1.....	Sets IP address of the default gateway (Router)
DNS*2.....	Sets IP address of the DNS server.

*1 Set [255.255.255.255] if the network does not provide the gateway (router).

*2 Set [255.255.255.255] if you do not use the function E-mail alert.

2. Select either "Manual" or "DHCP" from **IP configuration** pull down menu. When "DHCP" is selected, IP address, Subnet mask, Default Gateway, DNS are automatically configured by DHCP function. Only the DNS address allows you to set up manually if the DNS address information is not provided on your DHCP server. When selecting "Manual", configure all the items manually. For further information, contact your network administrator. The address must be entered as 4 number groups separated by a dot like [192.168.001.101].
3. After completing the network configuration, press **Set** button to register the network information.
4. To apply the setting, press **Select** button. The network of the projector starts re-booting and applies the setting. It takes about 20 seconds to complete. Close the web browser and access to the login page again in 20 seconds.

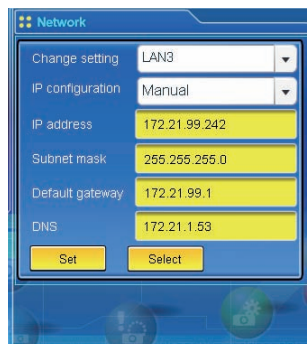

On the screen of the projector, the "Please wait..." message will appear and switching operation will start. Switching will take a while and after completing the operation, the "Ready for use" message will appear. During the switching period, the projector cannot be operated.



E-mail setting

This product has an E-mail function which can send an alert message to users or an administrator if it detects an abnormality on the projector or run out of the life span of the lamp. Click **E-mail Setting** on the main menu and follow the below steps.

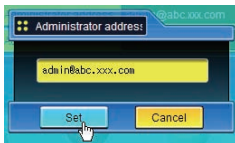

Item	Description
SMTP server*1.....	Sets server name or IP address of the SMTP server
Administrator address.....	Sets E-mail address of administrator
Add e-mail address.....	Sets E-mail address of the user to send a mail when the projector has an abnormality.

1 Setting SMTP server and administrator address

Set the server name or IP address of the SMTP server*1 and administrator address. The administrator address is set to "Reply-To" address of the message sent from the projector.

1 The SMTP server is a server for sending E-mail. Please contact your network administrator to have this SMTP server address. When the server name for SMTP server is used, DNS must be set up to activate the E-mail function.()p.23)

- ☞ If the projector sends an alert message due to the abnormality on the projector but the SMTP server is down in some other reason, the message will not be sent. In that case, the message "Unable to connect to server." will be displayed on the setting page. To clear this message, set up SMTP server address again.
- ☞ To use the E-mail function, it must be set the DNS address on the Network setting page correctly.
- ☞ You cannot use this E-mail function if the DNS server and SMTP server cannot be used in your network environment.
- ☞ The projector does not send message to the address set in "Administrator address" text box. If you want to send e-mails to the administrator address, enter the administrator address into "Add e-mail address" text box.

2 Registering and deleting E-mail addresses

Click "Add E-mail address" and type the E-mail address onto the text box and click **Set** button. To check the registered addresses, click **Check/Delete** sub menu tab. The addresses are listed as the figure on the right.

☞ Up to 10 E-mail addresses can be registered.

To delete the registered addresses, check the address you want to delete and click **Delete** button.

3 Option selection for sending alert mail

Click **Option** sub menu tab. Check the condition items under which alert mail will be sent and click **Set** button.

Please refer to the item "Examples :Type and contents of alert mail" described on the next page.

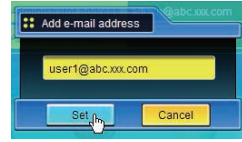

Check / Delete

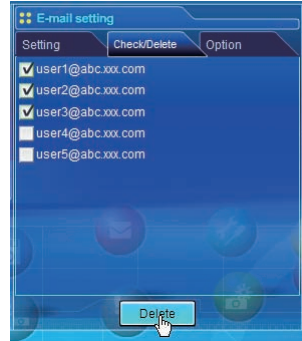

Option

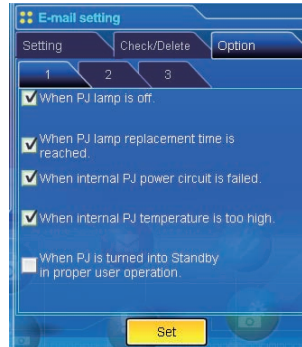

[1]-----

- When PJ lamp is off.
- When PJ lamp replacement time is reached.
- When internal PJ power circuit is failed.
- When internal PJ temperature is too high.
- When PJ is turned into Standby in proper user operation.

[2]-----

- When accumulated filter use time reaches [] hours.
- When Power management function turns PJ lamp off.
- When the signal is interrupted.

[3]-----

- When lamp Corres. Value reaches [] hours.

Attached message

- ☞ "When PJ lamp is off" signifies the lamp goes out without user operation. "When PJ is turned into Standby in proper user operation" signifies that the projector is turned on by using the web browser and then it is turned into standby with ON/STANDBY button on the top control or the remote control.
- ☞ The length of message should be less than 255 characters.
- ☞ Up to 99,999 hours can be set for use time.

Examples: Type and contents of alert mail

When the projector has an abnormality, the following alert messages are sent to the registered E-mail address depending on your selected condition. Administrator or user can take an efficient action quickly by receiving this message. This is very useful to maintain and service the projector. The following are examples of received messages.

● When internal PJ temperature is too high:

TITLE: Message from projector
 10-03-2007 00:59
 Projector Model Name: *model name*
 TCP/IP: 192.168.1.201 Projector Name: Proj05

It sends you following message.

*The Projector lamp is turned off, because internal Projector temperature is too high. Wait for the completion of the cooling process and make sure the projector has been turned into Standby. Then turn the projector on again.
 If the Indicator continues flashing, check the air filter for dust accumulation.

[A] 81.5 degrees fahrenheit [B] 134 degrees fahrenheit [C] 95.6 degrees fahrenheit
 Temperature of Sensor B is too high.

- ☞ The projector let users know the information which thermal sensors inside the projector detected the abnormal temperature risen and so the projector was turned off. Please refer to item "Power control and status check" (☞ p.32) for the location of the sensors and each temperature . Also see the owner's manual of the projector for further details.

● When internal PJ power circuit is failed:

TITLE: Message from projector
 10-03-2007 00:59
 Projector Model Name: *model name*
 TCP/IP: 192.168.1.201 Projector Name: Proj05

It sends you following message.

*The Projector lamp is turned off, because Projector power circuit is failed.
 Unplug the Projector from AC outlet and ask servicing to qualified service personnel.

MAIN, P-FAIL NG
 MCL, P-FAIL OK



- ☞ The projector lamp was turned off, because the projector power circuit failed. Unplug the projector from AC outlet and contact a qualified service personnel for service with the error information.

● **When PJ lamp replacement time is reached:**

TITLE: Message from projector
10-03-2007 00:59
Projector Model Name: *model name*
TCP/IP: 192.168.1.201 Projector Name: Proj05

It sends you following message.

*The PJ lamp replace time is reached.

☞ Replace it with a new lamp immediately and reset the lamp counter. If the projector is used without resetting the lamp counter, the alert mail is sent to users in every power-on of the projector. This alert mail will not be sent when the mail sending condition "When PJ lamp replacement time is reached" is unchecked.

● **When lamp corres. value reaches preselect use time:**

TITLE: Message from projector
10-03-2007 00:59
Projector Model Name: *model name*
TCP/IP: 192.168.1.201 Projector Name: Proj05

It sends you following message.

*The accumulated lamp use time reaches 1800 hours.
Prepare for the lamp replacement.

Discretional messages

☞ The projector sends a free message when the lamp use time (Corresponding value) reaches the preselected lamp use time. It can be used for preparation of the lamp replacement and the maintenance required.



SNMP setting

This product provides a SNMP (Simple Network Management Protocol) agent function. The SNMP consists of a manager and agents. The group which exchanges information with SNMP is called "Community". There are two access modes in a community, Refer (read only) and Set (read- write). This product allows to use Refer (read only) only. The SNMP message informs the projector status called "Trap" to an administrator. Click **SNMP Setting** on the main menu and set up each item.

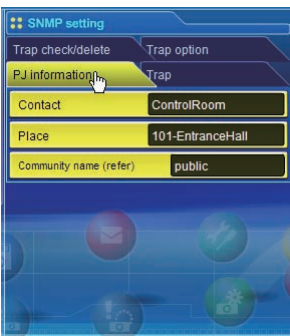

PJ information

Item	Description
------	-------------

Contact	Enter user name of the projector etc. (optional)
---------------	--

Place	Enter place of the projector (optional)
-------------	---

Community

name(refer)	Enter community name (read only). Default name is "public".
-------------------	---

⑩ The SNMP agent provided with this product is based upon MIB-2 defined by RFC1213. For private MIB information, refer to file "Mibinfo/XUPjNet.mib" in the CD-ROM.

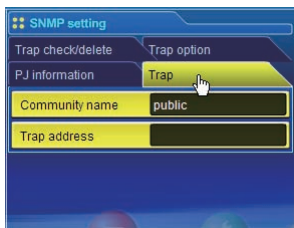

Trap

Item	Description
Community name	Enter community name to send "Trap". Default name is "public".
Trap address	Enter IP address of the SNMP manager computer to receive "Trap". Up to 10 address can be registered. ☞ Up to 10 trap addresses can be registered.

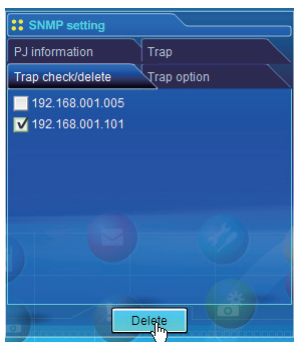

Trap check/delete

Check and delete the trap address

Checking the registered trap address and deleting the address.

To delete the address, tick the check box in front of the IP address and click **Delete** button.

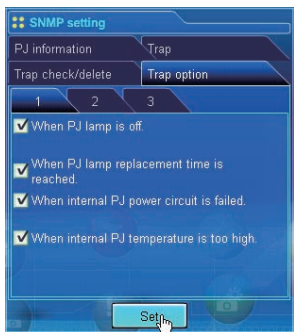

Trap option

Trap option setting

Tick the check boxes in front of the condition item to send the trap.

☞ Click **Set** button if you tick or un-tick the check box on a page.

☞ "When PJ lamp is off" signifies the lamp goes out without user operation. "When PJ is turned into Standby in proper user operation" signifies that the projector is turned on by using the web browser and then it is turned into standby with ON/STANDBY button on the top control or the remote control.

☞ Up to 99,999 hours can be set for the time setting.

[1]-----

- When PJ lamp is off.
- When PJ lamp replacement time is reached.
- When internal PJ power circuit is failed.
- When internal PJ temperature is too high.

[2]-----

- When PJ is turned into Standby in proper user operation.
- When accumulated filter use time reaches [] hours.
- When Power management function turns PJ lamp off.

[3]-----

- When the signal is interrupted.
- When lamp Corres. Value reaches [] hours.

4. Controlling the projector

Describes controlling and setting of the projector by using the web browser.



Power control and status check

Click **Power & Status** on the main menu. The control page will be displayed.

By clicking **ON** or **Standby** button on the page, the power of the projector can be controlled.

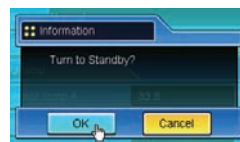

Popup confirmation window

Item	Description
------	-------------

PJ status

- PowerDisplays the status of the lamp. (ON, OFF, On starting up, On cooling down)
- StatusDisplays the status of the projector's power. (Refer to next page.)
- Power control.....Controls the projector power by clicking the "ON" or "Standby" button.

PJ temp.

- Inside temp.ADisplays the surrounding temperature of lamp in the projector.
- Inside temp.BDisplays the surrounding temperature of panel in the projector.
- External temp.Displays the surrounding temperature of the intake vent.



The warning icon will appear if the temperature exceeds a specified value. Check if there is no object to obstruct the airflow around the intake or exhaust vent. It might be airfilter clogged. Clean up the airfilter.

* The temperature unit can be set either Centigrade or Fahrenheit in the item "Initial Setting". (p.22)

☞ The projector cannot be turned on while the projector is cooling down.

☞ The web browser checks and updates the projector's condition every 30 seconds automatically.

About projector condition

Status	Description
Normal.....	Projector is operating normally.
Power management in operation.....	Power management is operating
Lamp failure.....	Lamp failure is occurring
Abnormal Temperature.....	The temperature of the projector became too high
Cooling down after abnormal Temp.	Projector detects abnormal temp. and is cooling down itself.
Standby after Abnormal Temp.	Projector detects abnormal temp. and is set into standby mode.
Power failure	Power failure has occurred inside the projector. Projector is turned off. Unplug the AC cord and contact a qualified service personnel for service. If the power failure occurs on the projector, "Power failure" is indicated on the status column and the information icon appears on the power column as shown below. Click this icon to display further information of the power failure.

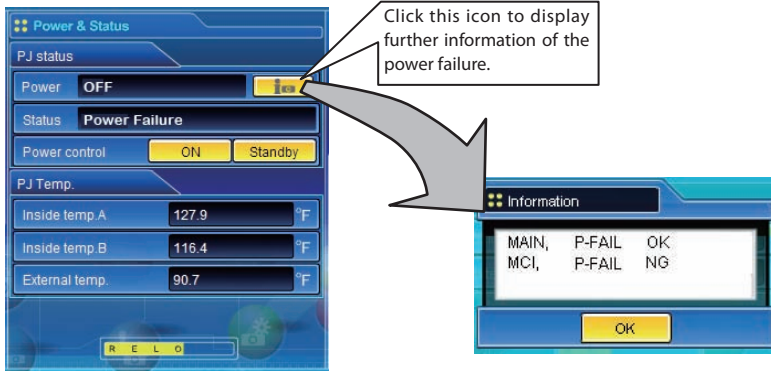

When a security (PIN code lock) has been set on the projector, you also cannot control it through the network. To control the projector through the network, unlock the security on the projector using with the projector's menu control.

Caution about turning on/off the projector via the networks

When turning on/off the projector via the networks, preset the projector as follows:

1. Select "Setting" from the Projector menu.
2. Select "Standby mode" from the Setting menu and set it as "Normal".

If you set this function as Normal, the network part of the projector is constantly provided with power even if the projector is turned off. If you set this as Eco, then the network part will be turned off when you turn off the projector. Consequently, you cannot turn on/off the projector via the networks.



Controls

Click **Control** on the main menu. The setting method differs depending on the contents of the page. Click on the page number to change pages and select desired setting items.

☞ Please see the owner's manual of the projector to have the further information of each control item.



Input

This function is to select the input mode and source mode of the projector. Click **Set** button after selecting the input and source mode.



Item	Description
Input.....	Selects input mode of the projector.
Source.....	Selects signal source of the input.
Computer1 :	RGB Component RGB(Scart)
Computer2 :	RGB
Video :	Auto Video S-video

☞ The control page displays valid control items depending on the selected input mode, signal or functions of the projector you use, therefore, there may be different controls between the described items and actual control items on the page display. For further information, refer to the projector's owner's manual.

☞ When the projector is standby, only the timer on the setting menu is available; others are not available.

System

This function is to select the system of signal input to the projector. The available system mode are listed on the pull-down menu button according to the input signal. Select a system and then click **Set** button.

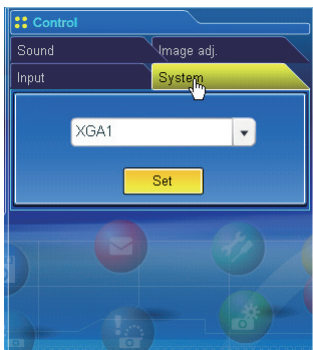

Available selection at the RGB input

Item	Description
XGA1	It automatically switches to the proper computer system of the input signal. * The computer system modes (VGA, SVGA, XGA, SXGA, UXGA, WXGA...) which meet the input signal listed.

Available selection at the Video/S-video/Scart input

Item	Description
AUTO	It automatically switches to the proper color system of the input signal. * The selectable color systems are PAL, SECAM, NTSC, NTSC4.43, PAL-M and PAL-N. * AUTO is fixed at the Scart input.

Available selection at the Component input

Item	Description
AUTO	It automatically switches to the proper scanning system of the input signal. * The selectable scanning systems are 480i, 575i, 480p, 575p, 720p, 1035i and 1080i.

☞ If the modes (Mode1 to Mode5) stored in the item "PC Adjustment" (p.38) are available, they are also listed together with the above mode.

Image adjustment

This function is to adjust the projected picture image and save the image mode. To store the adjusted value, click **Store** button, and to load the adjusted value, click **Load** button.



Item	Description
Contrast.....	Adjusts picture contrast
Brightness.....	Adjusts picture brightness
Color.....	Adjusts picture color saturation
Tint.....	Adjusts picture hue

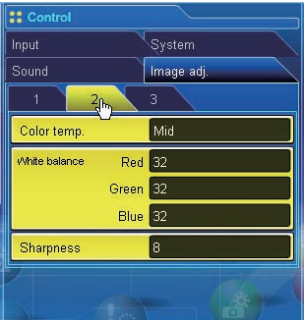

Item	Description
Color temp.	Sets a color temperature mode.
White balance Red, Green, Blue	Adjusts each white balance respectively.
Sharpness.....	Adjusts picture sharpness.

* When the value of the white balance is changed, the color temp. indicates "Adj."



Item	Description
Gamma.....	Adjusts brightness of darker part of the picture.
Noise reduction.....	Switches noise reduction mode
Progressive.....	Switches progressive mode
Reset.....	Resets the Image adjustment to previous levels.
Store.....	Stores the Image adjustment values. Select an item [Image 1 - Image 4] from the pull-down menu and click Store button.

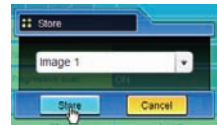

Load.....Loads the Image mode. Select an image mode from the pull-down menu and click **Load** button. There may not be available mode depending on the input mode as shown in the table left.

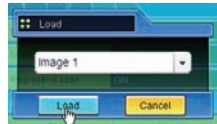

Input source		
Image mode	Video	Computer
Dynamic	✓	✓
Standard	✓	✓
Real	*	✓
Cinema	✓	*
Blackboard(Green)	✓	✓
Colorboard	✓	✓
Image 1 - 4	✓	✓

☞ The mark "✓" indicates the available image mode in the selected input source. The error message appears when the disabled image mode indicated with "*" is selected.

Sound

This function is to adjust the sound of the projector. The values in the text box represent the current control value or status.

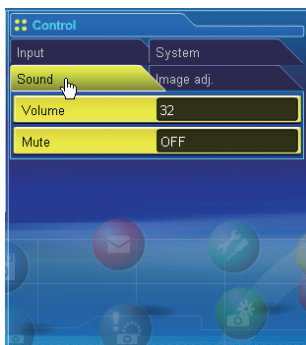

Item	Description
Volume	Adjusts the sound volume from the speakers.
Mute	Suppresses the sound.



PC adjustment

Click PC Adj. on the main menu. This function is to adjust the signal from the computer connected to the projector to obtain the proper picture image on the screen.

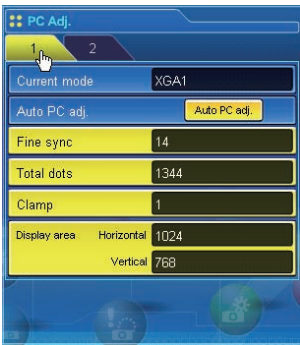

Item	Description
Current mode.....	Displays a current mode like VGA, SVGA, XGA, SXGA, UXGA, WXGA, etc. or MODE1 - MODE5 are the customized mode created by using the "Mode Store" function described below.
Auto PC adj.	Performs automatic adjustment.
Fine sync.	Performs Fine Sync adjustment.
Total dots.....	Adjust the number of total dots in the horizontal period.
Clamp.....	Adjusts the phase of the clamp.
Display area	
Horizontal.....	Adjusts the image area horizontally.
Vertical.....	Adjusts the image area vertically.

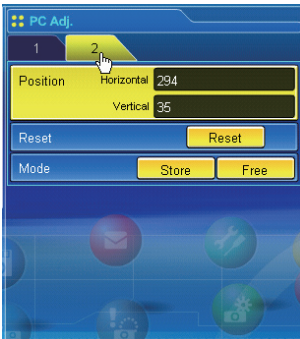

Item	Description
Position	
Horizontal.....	Adjusts the horizontal position of the screen.
Vertical.....	Adjusts the vertical position of the screen.
Reset.....	Resets the PC adjustments to the previous levels.
Mode Store	Stores the PC adjustment values. Select a mode no. [Mode1 - Mode5] from the pull-down menu.
Mode Free	Clear the PC adjustment values. Select a mode no. [Mode1 - Mode5] from the pull-down menu.



Setting up the projector

Click **Setting** on the main menu. This function is to set up the projector. Select the sub menu [Screen setting], [Setting 1] or , [Setting 2] and then set up each setting.

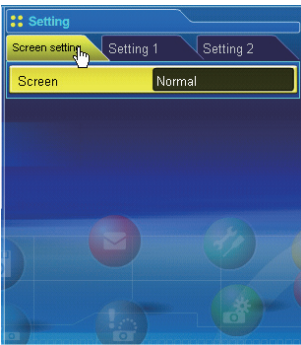

Item

Description

Screen.....Switches the screen mode. There may not be available mode depending on the input mode as shown in the table below.

Screen mode	Input source	
	Video	Computer
Normal	✓	✓
True	*	✓
Full	*	✓
Wide	✓	✓
Zoom	✓	*
Natural wide	✓	*
Custom	✓	✓

☞ The mark "✓" indicates the available screen mode in the selected input source system. The error message appears when the disabled screen mode indicated with "*" is selected.

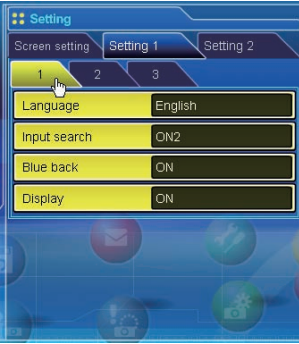

Item	Description
Language	Sets the language display of projector's on-screen display menu.
Input search.....	Sets the auto-input signal detection mode.
Blue back	Sets the blue screen background when no signal input.
Display.....	Switches on or off the on-screen menu display on the screen.
Countdown off	Displays image during the starting up.

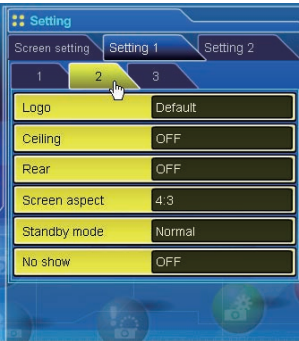

Item	Description
Logo	Sets the logo display on the screen during the startup.
Ceiling.....	Sets the image top/bottom and left/right reversed.
Rear.....	Sets the image left/right reversed.
Screen aspect.....	Sets the aspect to 4:3, 16:9 or 16:10.
Standby mode	Sets the network function enable or disable in the standby mode.
	Normal..... Enable
	Eco Disable
No show	Sets the black out image temporarily.

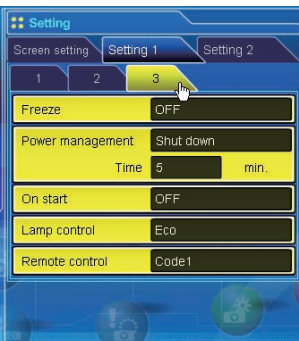

Item	Description
Freeze.....	Sets the image to freeze mode.
Power management	Sets into the selected power management mode if the input signal is interrupted and no control key is pressed for the specified period of time.
	*The specified time can be set 1 to 30 min.
On start	Sets the power-on mode when the AC cord is connected to the outlet.
Lamp control.....	Selects lamp control mode.
Remote control	Sets the remote control code.



Item	Description
Fan	Sets the cooling options after turning off. L1 Normal cooling L2 Silent cooling
Fan control.....	Sets the fan control speed. Off Normal mode On1 Highland mode 1 On2 Highland mode 2
Lamp Corres. Value (h)	Displays the lamp use time (Corresponding value) . Reset the time after the lamp is replaced.
Terminal	Sets the COMPUTER IN 2/MONITOR OUT terminal to Computer 2 or Monitor Out.

Lamp counter resetting

1. Select a Lamp radio button and then click **Reset** button.
2. Click **OK** button to execute the reset.

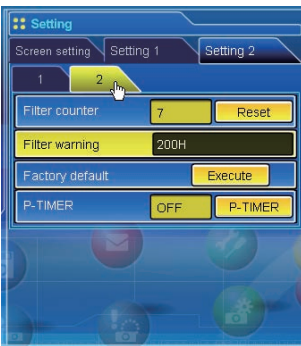

Item	Description
Filter counter.....	Displays the filter use time. Reset the time after filter clean-up.
Filter warning.....	Sets the time to indicate the filter warning message on the screen.
factory default.....	Sets all of the projector control items to the factory default setting except the following items. Lamp Corres. Value, PJ time, Filter time, PIN code lock and Logo PIN code lock.
P-TIMER	Switches the P-TIMER display. ON Starts P-TIMER indication STOP Stops P-TIMER counting OFF Stops P-TIMER indication



Timer setting

This page is to set the timer to turn the projector off or on at a programmed day/date and time. Follow the steps below for setting.

Click **Timer** on the main menu.

"---" will appear on the current time when the time is not set up correctly.

Present time set on the projector



How to set the timer

1 Set a day or date

To set the timer event at the same time everyday or every week,

Select **day** entry with radio button and then select desired day from the pull-down menu button.

The selectable days are as follows:

- Same time everyday
- Every week (days from Monday to Sunday)

To set the timer event on specified date,

Select **date** entry with radio button and then type the date with (Year/Month/Date) format.

Ex.: Type [2007/12/20] if you specify [December 20, 2007].

This projector does not provide the built-in battery. The date and time information are lost when the projector turns off (when "Eco" is set for the stand-by mode (Refer to p.40)), or the network configuration is reset, or the wired setting is switched to LAN1/LAN2/LAN3/Off. The timer function is disabled until time is set up correctly. When using the NTP address for time setting, the current time is acquired at the projector starting up and the timer function is activated after finishing the time setting correctly.

2 Set an execute time

Type the time with (Hour:Minute) and 24 hours format.

Ex.: Type [18:25] if you specify [PM 6 o'clock and 25 minutes].

3 Select an event action

Select an event action from the pull-down menu.

Event	Action
ON	Turns on the projector
OFF	Turns off the projector
Lamp Auto	Changes lamp mode to "Auto"
Lamp Normal	Changes lamp mode to "Normal"
Lamp High	Changes lamp mode to "High"

4 Register an event

Click **Set** button to register the set timer event. Repeat steps 1 to 4 for another timer event setting.

Check the timer events

To check the set timer events, click **Check** button. The timer events are listed. The event with blue background color represents the timer-OFF event.

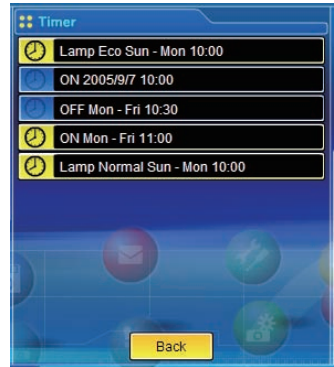

Change the event mode

On the event list appearing by clicking **Check** button, click on the event you want to delete, disable or enable. Click **Cancel**, **Delete**, **Timer ON** or **Timer OFF** button on the popup pallet.

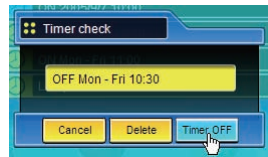

Button	Operation
Cancel	Cancels the setting
Delete	Deletes the timer event
Timer OFF	Disable the timer event temporarily
Timer ON.....	Enable the timer event

Notes on timer setting

Up to 10 timer events can be registered. Timer events always operate according to the next valid event depending on the projector's power status. In the example below, event 3 turns on the projector so next event 4 (also turning on projector) will not be effective because the projector is already turned on. Similarly, when the projector is turned off by event 5, event 6 OFF will not be effective in turning it off again. But these secondary events (event 4 and event 6) will become effective if a person turns off the projector (after event 3 and before event 4) or turns on the projector (after event 5 and before event 6).

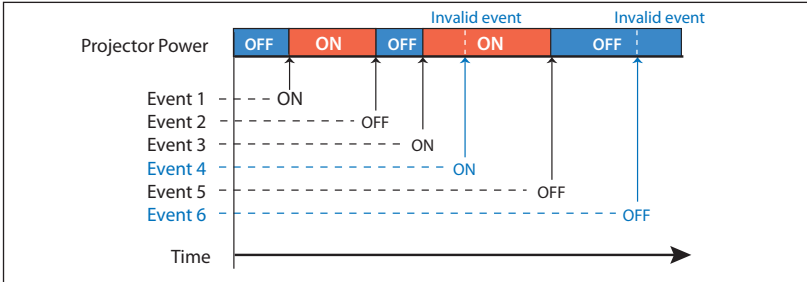

- When the timer events are set at the same time, the last event set will override the previous events. For example, if there is an event like "ON at 8:00 everyday" and then new event is set like "OFF at 8:00 everyday", only the last setting event is effective.
- When the timer event **ON** occurs during cooling down period, this is invalid event because the projector cannot be turned on during that cooling down period.



Projector information



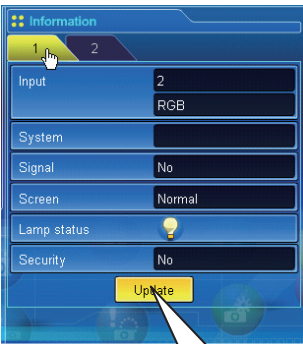



This page is to display the basic information of the projector status. Click **Information** on the main menu.



Click this button to update the information

Items	Description
Input.....	Displays selected input and source.
System	Displays selected signal system.
Signal	Input signal status
Screen	Displays screen mode.
Lamp status	Displays lamp status with an animation. Refer to the table on the next page.
Security	Displays the security (PIN code lock) status

Indication of the lamp status

Icon display/background	Status
 White-Yellow/Blue	Lamp on (Normal)
 White-Yellow/Red	Lamp on (Lamp is being used over a specified use time, replace lamp immediately)
 Gray/Blue	Lamp off (Normal)
 Gray/Red	Lamp off (Lamp is being used over a specified use time, replace lamp immediately)
 Red/Blue with X	Lamp failure (Lamp failure, check the lamp condition)
 Red/Red with X	Lamp failure (Lamp failure and lamp is being used over a specified use time, replace the lamp immediately)

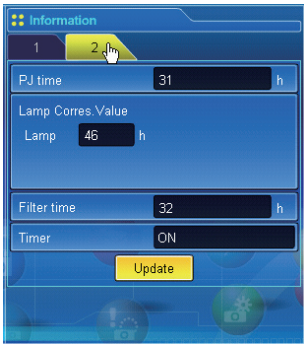

Items	Description
PJ time	Displays the accumulated use time of the projector.
Lamp Corres. Value	Displays the use time (Corresponding value) of the lamp.
Filter time	Displays the use time of the filter.
Timer	Displays the timer setting status.
	ON Timer has been set.
	OFF No timer setting.



Multi-control

Controlling and setting the multi-projectors

When you install multiple projectors in the network, you can control and set up them together. Click **Multi Control** on the main menu to display the control page.

Note:

To control the multiple projectors, each projector must be set the same Network PIN code.



Example of multi control

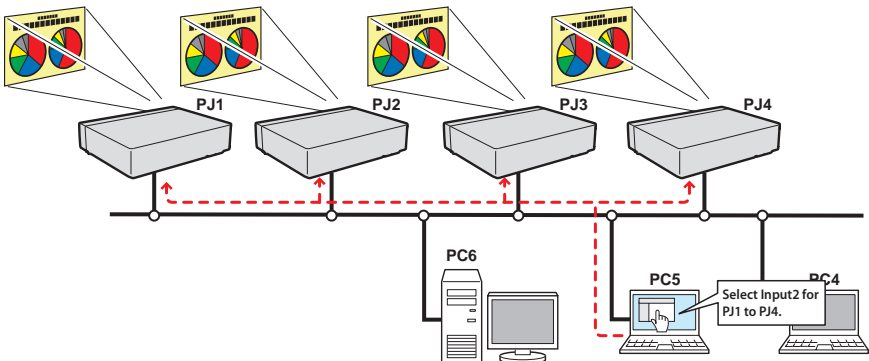

Start/stop the multi control

To start or stop controlling the multi-projectors, click Multi control setting menu and select ON or OFF.

Multi control setting

- OFFStops multi control function
- ON.....Starts multi control function. The multi control menu will appear when ON is set. These items of menu are linked to the main menu.

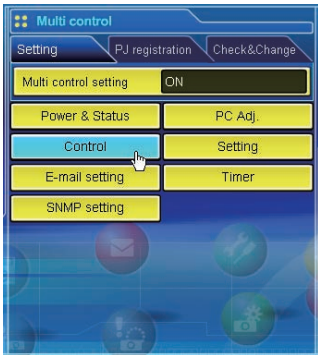
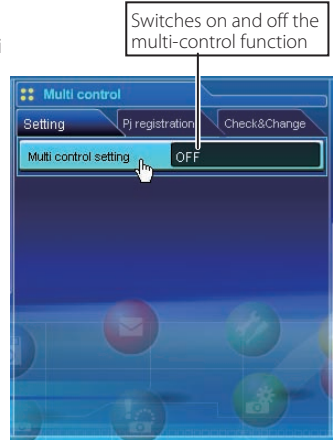

The multi controllable menus are "Power & Status", "PC adjustment", "Control", "Setting", "E-mail setting", "Timer" and "SNMP setting". Click each menu and perform setting and adjustment.

☞ The word "MULTI CONTROL" appears on the each control page while the multi control is operating.

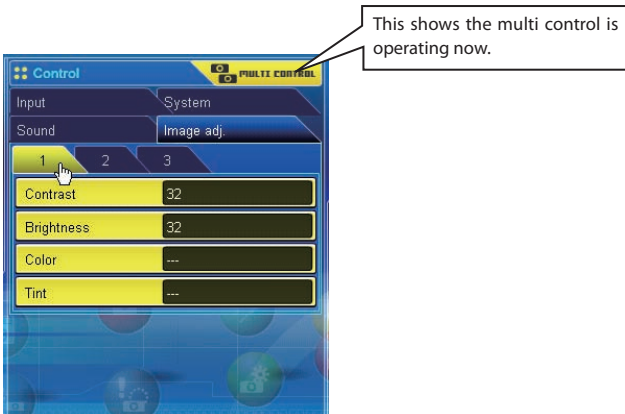

Register the projector

To use the multi control function, register the IP address of the projector you intend to control. Click Pj registration sub menu tab and set the IP address and Memo, then click Set button.

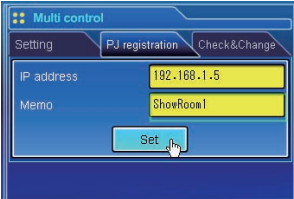

Items	Description
IP address	Enter IP address of the projector to control
Memo.....	Enter projector name or installed location etc.

Confirmation of registered projector

To check the registered information, click **Check & Change** sub menu tab. The registered information of the projector is listed as the below.

* The word "none" is displayed if the "Memo" function is used.

* When you click on a listed IP address, the login page for the selected projector will be displayed with a new window.

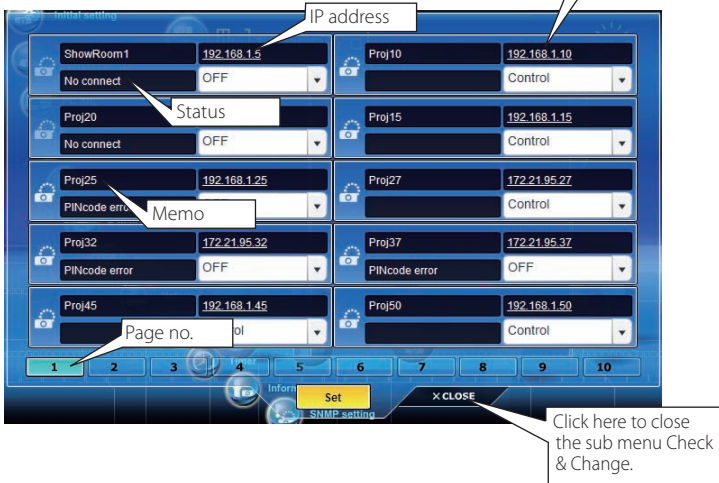

Click here to close the sub menu Check & Change.

Change the mode of the registered projector

To change the mode of the registered projector, select a mode with the pull-down menu button under the IP address of the target projector and then click **Set** button.

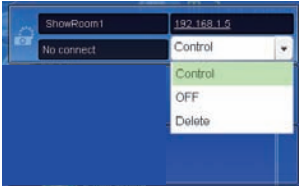

Mode	Operation
Control.....	Controlling the projector
OFF.....	Excluding from the multi-control
Delete	Deleting from the multi-control

Status

If some of the registered projectors are disabled by some reasons (such as disconnecting the power source, disconnecting the LAN cable, disconnecting from the network), control changes will continue to be effective for the projectors that are still active. At the same time, the deactivated projectors are excluded from the multi-control. The status of the registered projectors are indicated under the projector name. See the table below for status indications.

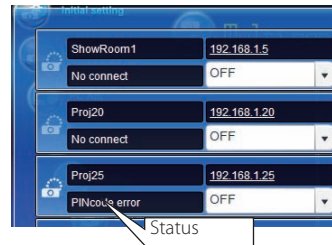

Status	Description
(blank).....	The projector is connected to the network correctly
No connect	The projector may not be connected to the network. Please check the connection and network configuration of this projector.
PIN code error.....	The PIN code is incorrect. The PIN code for the multi-controlled projectors must be the same. Change the PIN code of this projector to the common PIN code. (p.12)

* The projector updates the status at the time when the multi-control function is executed.

- ☞ If the multi-controlled projector is in the standby mode, items of "PC adj.", "Control" and "Setting" cannot be operated.
- ☞ It is recommended that a specified projector should be chosen for setting as a master when you use this multi-control function. The control for the multi-controlled projectors will become too complicated operation if this function is used for each projector.
- ☞ If the registered projector is not connected to the network, it will take a while to complete the multi-control operation because of waiting for the response from each registered projector.
- ☞ There are some disabled items in the multi-control function for the light mode.

Check & Change page in the light mode

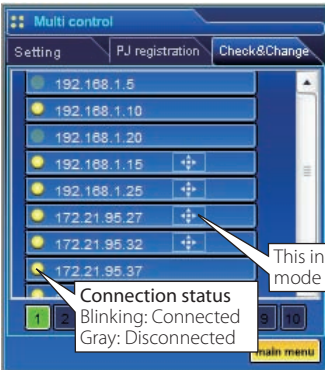

Following functions in the "Check & Change" page are not available in the light mode.

- Changing the control mode.
- Deleting the registered IP address
- Indicating the each status
- Indicating the each memo

This indicates that the mode is "Control".

(Check & Change page in the light mode)

Controlling all together

"Power & Status", "PC adjustment", "Control" and "Setting" can be controlled all together. Set "ON" the multi control setting and adjust controls of each menu. The setting value is applied to the registered projectors sequentially.



Setting all together

"E-mail setting", "SNMP setting" and "Timer" can be set all together. Set "ON" the multi control setting and items of each menu. The setting value is applied to the registered projectors sequentially.



Chapter 5

5. Appendix

Use of telnet

Web browser setting

Troubleshooting

Terminology

Use of telnet

You can control the projector by using the telnet application¹⁾ installed on your computer. Normally, the telnet application is available on your computer.

* The telnet 10000 port is used to control the projector.

Control

(For example, in case of using the telnet application of **Windows XP Professional**.)

1. Select **Run...** submenu from **Start** menu on the computer. Type "telnet" onto the **Open** text area on the displayed window and press **OK** button.

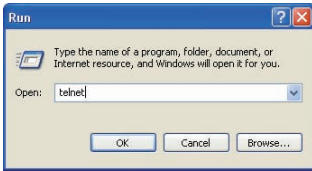

2. The telnet application will start and the following window will be displayed. Type as below to connect the projector.

> open 192.168.1.201 10000 [return]

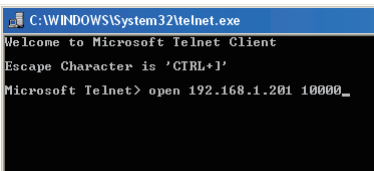

* Use the IP address assigned to the projector

3. When communication is established correctly, the word "PASSWORD:" appears on the window. Type the login password (Network PIN code²⁾) for the projector and then press "Enter" key on the keyboard. If you do not set up the Network PIN code, just press "Enter" key. When the word "Hello" is replied, login has been succeeded.

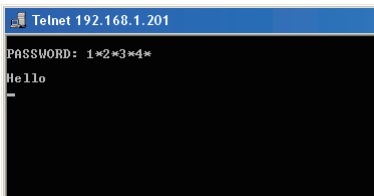

* The password "1234" is used for the example.

(For example, in case of using the telnet application of **Mac OS X v 10.4**)

1. Select **Terminal** from **Applications --> Utilities**. Type as below on the displayed window.
> telnet [return]

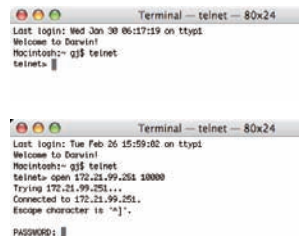
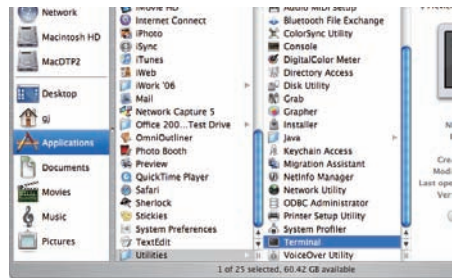

4. Type the commands, refer to below table, to control the projector and then press "Enter" key for termination. For example, type "C00" which is a command to turn on the projector, and press "Enter" key. Confirm the projector is turning on.

* Enter with ASCII 64-byte capital characters and one-byte characters.

To disconnect the communication, press "Ctrl" key and "]" key at the same time, type "close" and then press "Enter" key on the Keyboard.

> close [return]

The table below shows the typical command lists for controlling this projector and please consult your local dealer for further information of another commands.

Command list table

Command	Function
C00	Power on
C02	Power off
C09	Volume up
C0A	Volume down
C0B	Audio Mute on
C0C	Audio Mute off
C1C	Menu display on
C1D	menu display off

*1 Further instructions about the telnet application, please see the on-line guide on your computer.

*2 The password is a Network PIN code decided item "Network PIN code setting" (p.12). If the authentication of the entered password is failed 4 times continuously, the communication will be disconnected automatically. Please try again for the connection.

*3 If the password or any command is not entered for more than 30 seconds, the communication will be disconnected automatically. Please try again for the connection.

Web browser setting

This product is designed to enable the projector to be set up and controlled from an Internet web browser. Depending on the preference settings of the web browser, some control functions may not be available. Please make sure that the following functions are set up properly in the web browser.

Active Script/JavaScript enable

There are some control items used with the JavaScript function in the setting pages. If the web browser is set not to use this JavaScript function, it may not control the projector properly. In that case, the following warning message will be displayed on the top of the page. To enable the JavaScript, please see further instructions on the next page.



Flash Player enable

The setting page of this product contains the Flash contents. To display the setting page, the Adobe Flash Player version 6 or later is required to be installed on your computer. For further product information, see the Adobe homepage. (<http://www.adobe.com>). Even if your computer provides the Adobe Flash Player, the setting page does not appear on the web browser, in which case, check that Flash Player Plug-In(Shockwave Flash) is installed and set up correctly. please see further instructions on the next page and it is depending on the web browser.

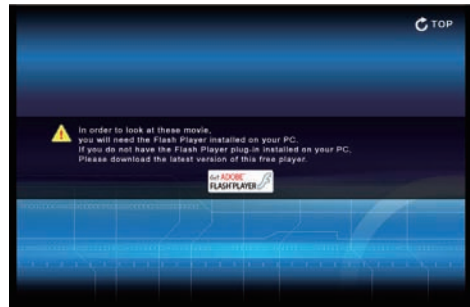

Proxy setting

In some cases, your web browser is set up to use the proxy server for the internet or intranet connection. In that case, when you install this product into the local network, you should set up the proxy setting of web browser preference correctly. Especially when connecting the projector and computer with a UTP cross cable directly, or when the network does not provide the proxy server, make sure that "not use proxy server" is set up in your web browser preference. Please see item "Examples: OS/Browsers" in the next page for further setting up procedure.

☞ There are various ways to change your browser preferences depending on the version or applications. Please see the setting instructions on next page showing examples and also refer to on-line help of your web browser.

Examples: OS/Browsers

Windows XP Professional

Internet Explorer v.6.0

ActiveScript setting

Select **Internet Options** from **Tools** menu on the web browser and then select **Security** tab and click **Customize Level...** button. On the security setting window, scroll down and find the **Scripting** item, make sure that "Enable" is selected in item **Active Scripting**.

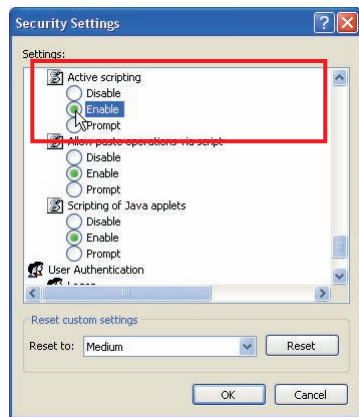
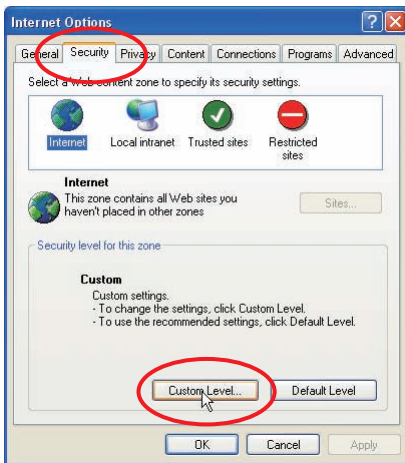

Flash Player enable

ActiveX controls and plug-ins setting

Select **Internet Options** from **Tools** menu on the web browser and then select **Security** tab and click **Customize Level...** button. On the security setting window, scroll down and find the **ActiveX controls and Plug-ins** item, make sure that "Enable" is selected in item **Run ActiveX controls and plug-ins**.

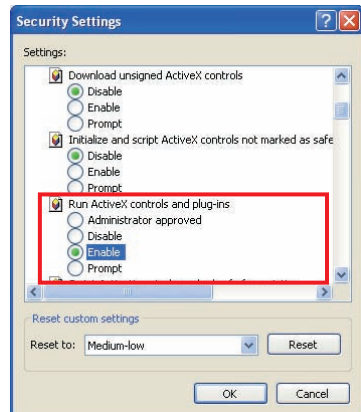

Flash Player Add-on setting

Select **Manage Add-ons...** from **Tools** menu on the web browser. Select "Add-ons currently loaded in Internet Explorer" from **Show** pull-down menu. Make sure that the "Shockwave Flash Object" is listed under the item "Enabled".

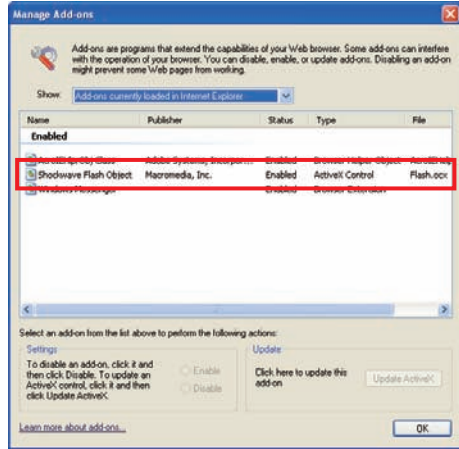

Proxy setting

Select **Internet Options** from **Tools** menu on the web browser and then select **Connection** tab and click **LAN Settings** button. Properly set up your web browser's the proxy server settings according to the local area network environment to which the projector is connected.

- Using proxy server

To use an external internet connection from the local area network, check the item **Use a proxy server** and enter the proxy server address and port correctly in the proxy settings window. For further instruction please consult your network administrator.

- Not using proxy server

Uncheck the item **Use a proxy server**.

If you connect the projector to the computer directly with UTP cross cable, it must be unchecked.

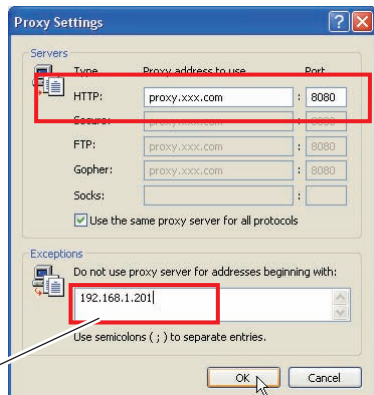
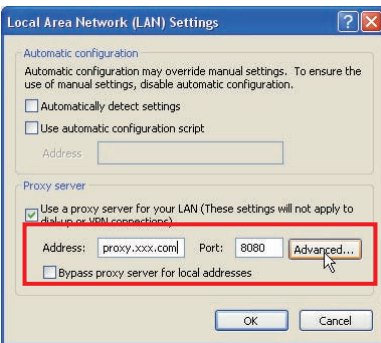

To designate proxy settings that will not use the proxy server when accessing the projector installed in the local area network, enter the IP address or domain name here.

Netscape Navigator v.7.0

JavaScript Setting

Select Preference from Edit menu on the web browser and then select the item **Advanced/Scripts & Plugins** in the **Category** column. Make sure that the **Enable JavaScript for Navigator** is checked.

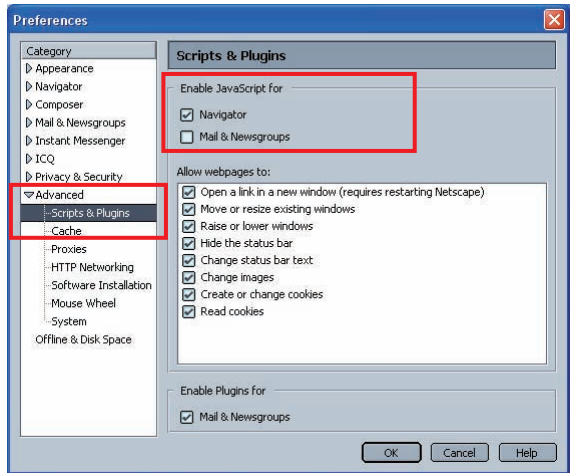

Flash Player enable

Flash Player Plug-in setting

Select **About:Plug-ins** from **Help** menu on the web browser. The plug-ins software provided on the browser are listed on the page. Check that the **Flash Player Plug-in (Shockwave Flash)** is installed and set up correctly as below.

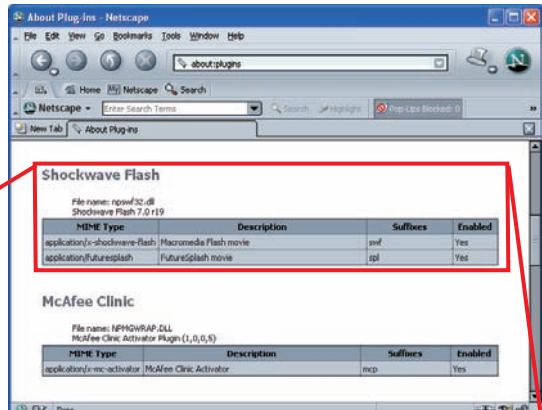

Shockwave Flash

File name: npswf32.dll
Shockwave Flash 7.0 r19

MIME Type	Description	Suffixes	Enabled
application/x-shockwave-flash	Macromedia Flash movie	swf	Yes
application/futuresplash	FutureSplash movie	spl	Yes

Proxy setting

Select **Preference** from **Edit** menu on the web browser and then select the item **Advanced/Proxies** in the **Category** column. Properly set up your web browser's the proxy server settings according to the local area network environment to which the projector is connected.

- Using proxy server

When you use an external internet connection from the local area network, select the item **Manual proxy configuration**. Enter the proxy server address and port number correctly on **HTTP Proxy** item. For further instruction please consult your network administrator.

- Not using proxy server

Select the item **Direct connection to the Internet** in the proxy setting window. If you connect the projector to the computer directly with UTP cross cable, this must be selected.

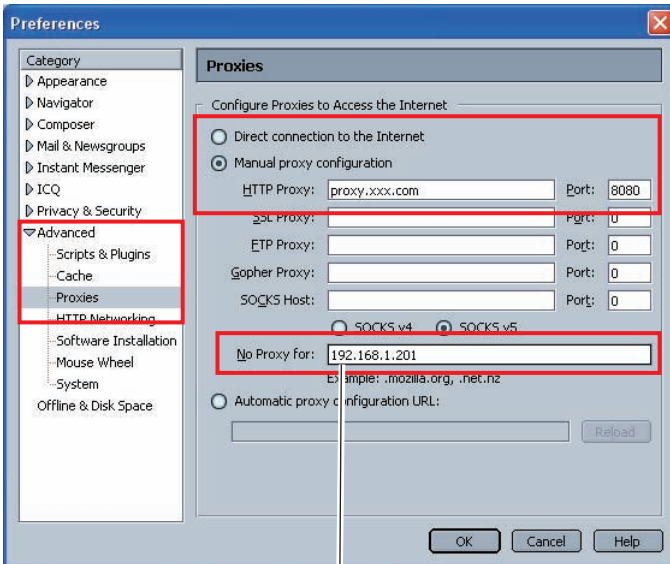

To designate proxy settings that will not use the proxy server when accessing the projector installed in the local area network, enter the IP address or domain name here.

MAC OS X v 10.4

Safari v.3.0

JavaScript and Flash Player enable setting

Select **Preferences...** from **Safari** on the web browser and then select **Security** tab and check **Enable plug-ins** (for flash player) and **Enable JavaScript**.

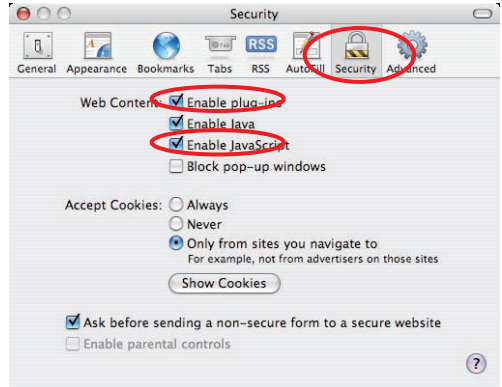

Proxy setting

- 1 Open **Preferences...** from **Safari** menu on the web browser **Safari**. The preference menu appears.
- 2 Select **Advanced** icon and then click **Proxies: Change Settings ...**
- 3 Select **Proxies** tab and properly set up your web browser **Safari**'s the proxy server settings according to the local area network environment to which the projector is connected.

- Using proxy server

To use an external internet connection from the local area network, check the items **Web Proxy (HTTP)** and **Secure Web Proxy (HTTPS)** of **Select a proxy server to configure** window and enter the proxy server address and port correctly in **Web Proxy Server** window. For further instruction please consult your network administrator.

- Not using proxy server

Uncheck the items **Web Proxy (HTTP)** and **Secure Web Proxy (HTTPS)** of **Select a proxy server to configure** window.

If you connect the projector to the computer directly with UTP cross cable, they must be unchecked.

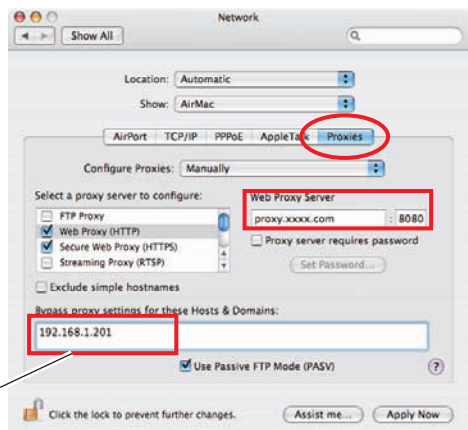
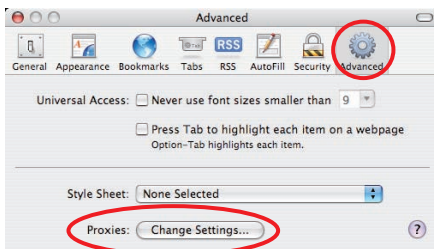

To designate proxy settings that will not use the proxy server when accessing the projector installed in the local area network, enter the IP address or domain name here.

Troubleshooting

If you have any trouble in setup or operation of the projector, refer to the troubleshooting items and check the relevant matters described.

■ The computer cannot connect projectors.

Is the LAN cable connected to the projector properly?

Is the LINK/ACT lamp of the LAN terminal lighting properly?

Not lighting : The LAN setting of the projector is set "On"?

See "Wired LAN setting" in the projector menu.

The LAN cable is connected to the network HUB properly?

■ Connection between computer and the projector via Wired LAN cannot be established.

When selecting LAN1 (factory default setting)

Check IP address, Sub net and Gateway of the projector and computer. For further details of the configuration, contact your system administrator.

Is the segment where the projector is installed different from the projector?

■ Cannot start up the browser

Check settings for Wired LAN.

Check settings of the proxy setting at browser. Refer to "Web browser setting" (p.56).

■ Cannot be turned on/off with the web browser.

Make sure the settings of the projector are correct to use the projector with it.

Set the item Standby mode to "Normal" from Main menu → Setting menu.

Refer to "4. Controlling the projector" → "Power control and status check" (p.32).

Terminology

.....

DHCP server (Dynamic Host Configuration Protocol)

It is necessary to set an IP address for each computer or equivalent equipment when a network is established by TCP/IP. If there exists DHCP server on the network, it will assign IP addresses to client computers every time they request it. If there exists equipment with DHCP server functions (such as a Windows 2000 server and a dial-up router) on the network, the DHCP server function may be automatically operating. Ask your system administrator whether the DHCP server is operating.

MAC address (Media Access Control Address)

MAC address is a physical address for every network interface. The MAC address consists of 6-byte hex number. The first 3 bytes are a Vendor ID controlled and assigned by IEEE. The last 3 bytes are controlled and assigned by the manufacturers of network interface (no duplication of MAC address). Therefore, MAC address is a unique physical address in the world. Ethernet sends and receives frames on the basis of MAC address.

