



Sonic AT8 ISF eFinity Series

Acoustically Transparent EDGE FREE® Fixed Frame Screen

USER'S GUIDE



Product Description:







The **Sonic AT8 ISF eFinity Series** is a fixed frame projection screen that uses EPV's EDGE FREE® technology. The EDGE FREE® design resembles a flat panel TV display. The **eFinity** includes a micro-thin bezel trim to further enhance the frame appearance and absorb projector overshoot.

The screen material included is our ISF certified **Sonic AT8 ISF**, which is a high-resolution acoustically transparent front projection material for speaker placement behind the screen.

In order for the **Sonic AT8 ISF** to maintain its projection qualities and optimum performance, please refer to the list below for proper maintenance and cleaning.







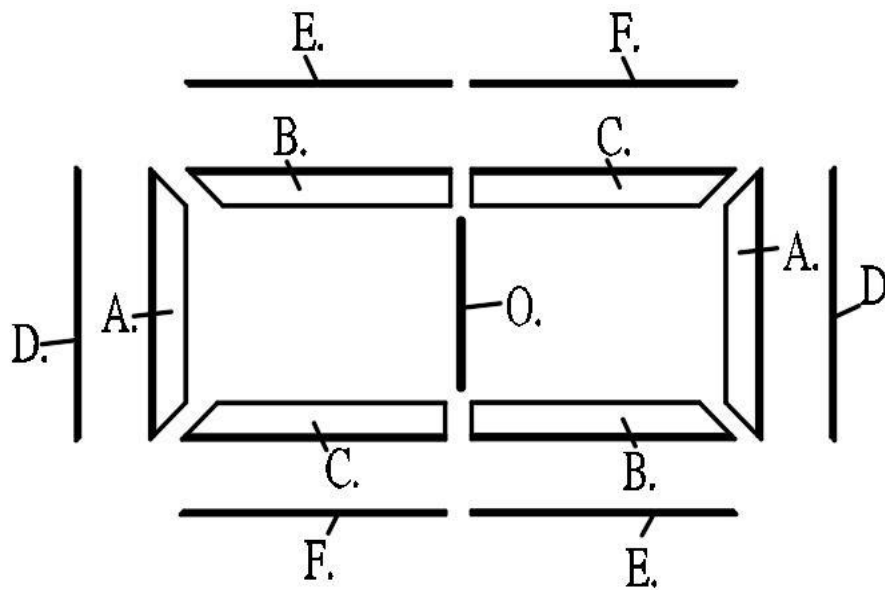



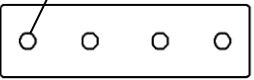
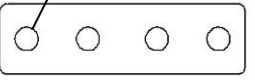
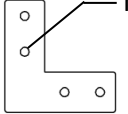
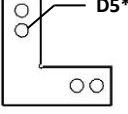
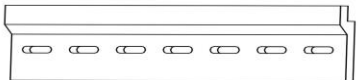

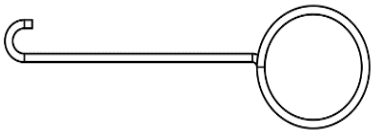
- Use a soft bristle brush to spot clean for dust.
- Dip a soft bristle toothbrush in mild soap and water to clean light stains.
- Never rub or apply pressure when cleaning the surface.
- Never attempt to use any solutions, chemicals or abrasive cleaners on the screen surface.
- To avoid damaging the screen, avoid touching it directly with your fingers, pens/pencils or any other sharp or abrasive objects.

1. Frame and Edge Trim Parts List

Qty item	2 pcs Main Frame Parts	Qty item	2 pcs Edge Trim Parts
Part A.	vertical frame 	Part D.	
Part B.	½ horizontal frame 	Part E.	
Part C.	½ horizontal frame 	Part F.	



2. Hardware Parts List

a. 	b. 	c. 	d. 
e. 	g. 	h. 	i. 
j. 	k. 	l. 	m. 
o. 	q. 	p. 	r. Red →  Black → 

Item	Parts List	120"	135"
a.	Center Joints- M4 (bottom position)	6	6
b.	Center Joints-D5 (top position)	4	4
c.	Elbow Joints M4 (bottom position)	8	8
d.	Elbow Joints D5 (top position)	4	4
e.	Top wall brackets	2	2
g.	M4x7 Screws	32	32
h.	Spring	68	78
i.	Spring Hook	2	2
j.	Bottom wall brackets	2	2
k.	Φ5x50 Wall Screws	6	6
l.	Hollow Wall anchors	6	6
m.	M4x4 Screws	24	24
n.	Angle cover	4	4
o.	Center Support Bar	1	1
p.	White gloves	2	2
q.	Spring	6	6
r.	Φ3 mm Long Iron (sides) rod/ Short rod (top/bottom)	2/4	2/4

Frame Assembly

Step 1: Place the included soft padded EPE sponge sheet on a clean area where the screen will be assembled.

Step 2: Position the pieces of the frame on the EPE sponge in the arrangement shown below.

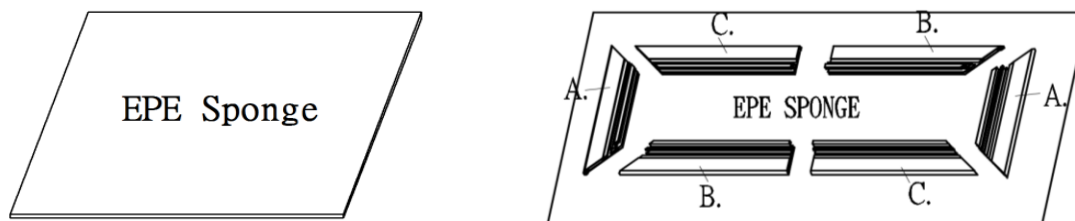

Step 3: Insert *center joint (a/b)* connectors into *one-half of the horizontal frame (B/C)* and secure with the *M4x7 screws (M)* as shown in the illustration below.

Tip: The center joint (b) with the larger diameter holes should be on top.

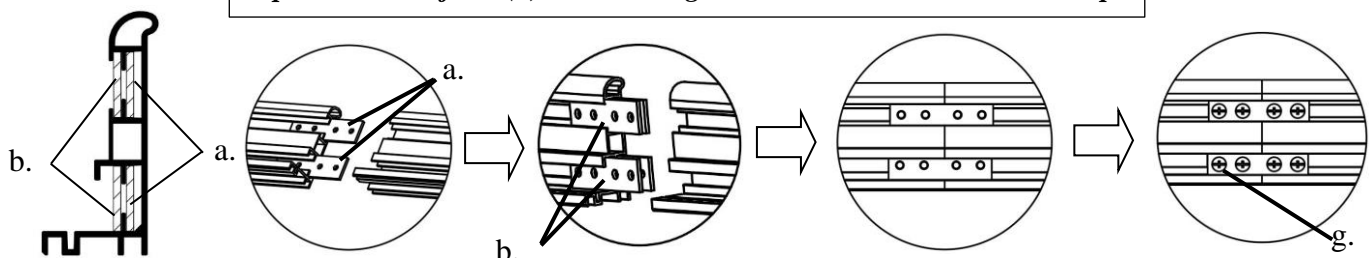

Step 4: Connect the *elbow joints (c/d)* to the top and bottom sections of the vertical frame. Once inserted, connect the vertical sections to the horizontal frame sections. Make sure all holes are in alignment and the frame pieces are flush (no gaps). They should form perfect right angles.

Tip: The elbow joint (d) with the larger diameter holes should be on top.

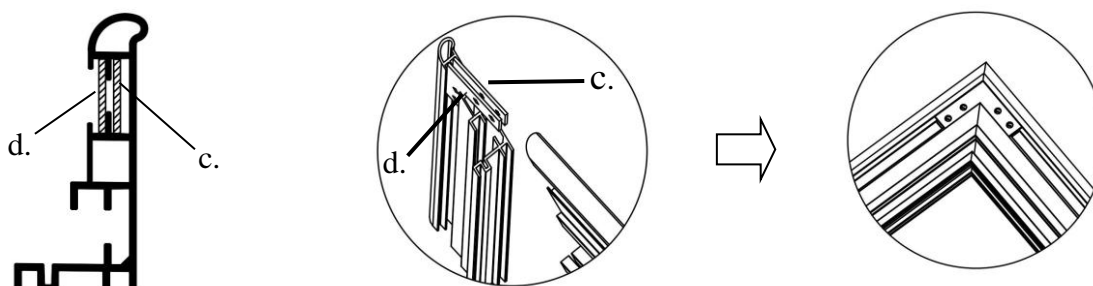

Step 5: Secure the elbow joints by fastening them with *M4x7 screws (g)*, 4 at each corner.

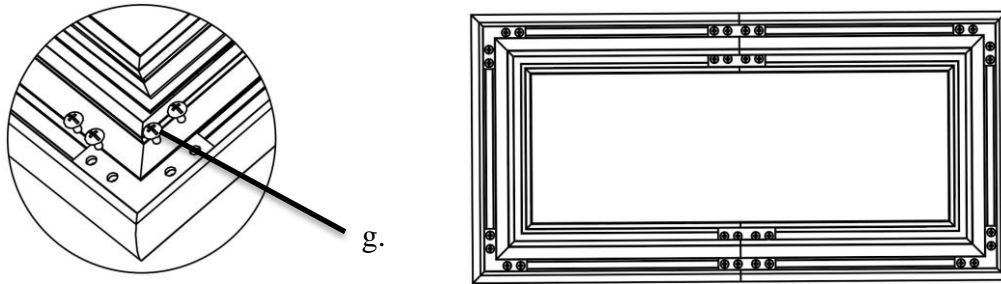

Screen Material

Step 6: Put on the *white gloves (p)* and carefully unroll the screen material on a clean surface from the roller to the other side as shown below. The back side of the screen material should be placed upwards.

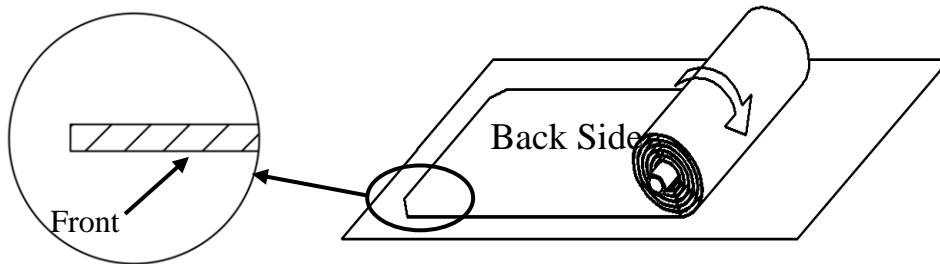

Step 7: Insert the *rods (r)* through the sleeves according to their corresponding lengths on each edge of the screen as shown below. The short rods (top/bottom) will overlap to secure a firm grasp in the middle areas.

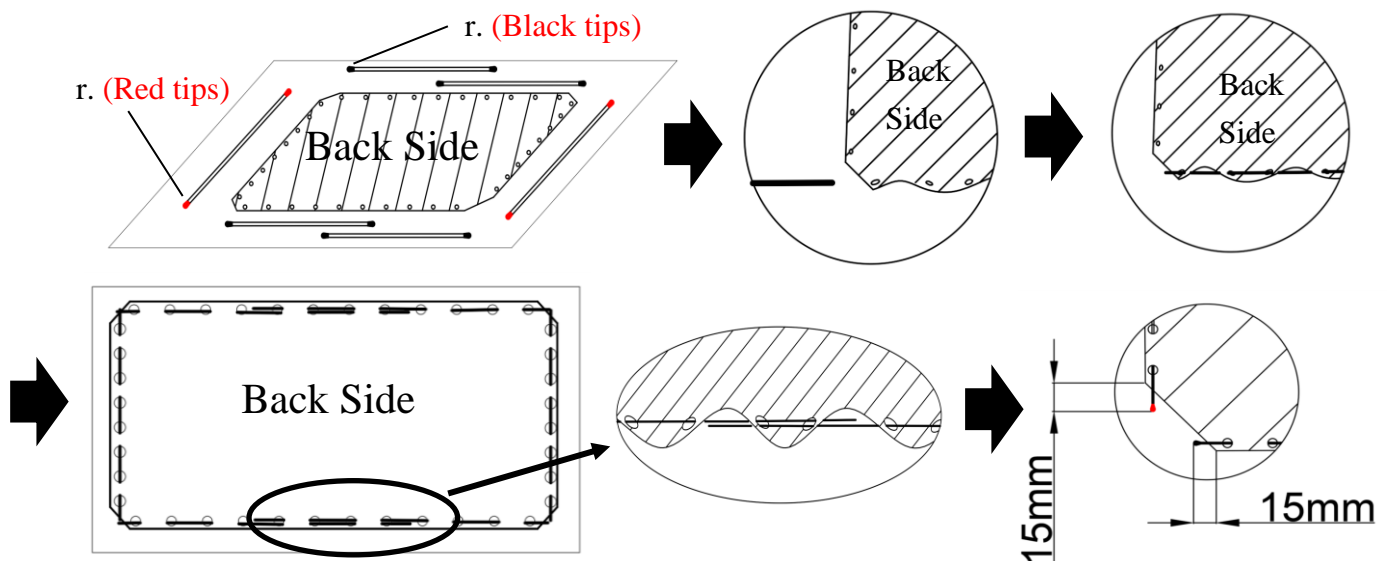

Step 8: Carefully and gently place the assembled frame on top of the screen material in the marked areas as shown below. Make sure to not allow the angle edge of the frame to come in direct contact with the screen material to avoid puncturing it.

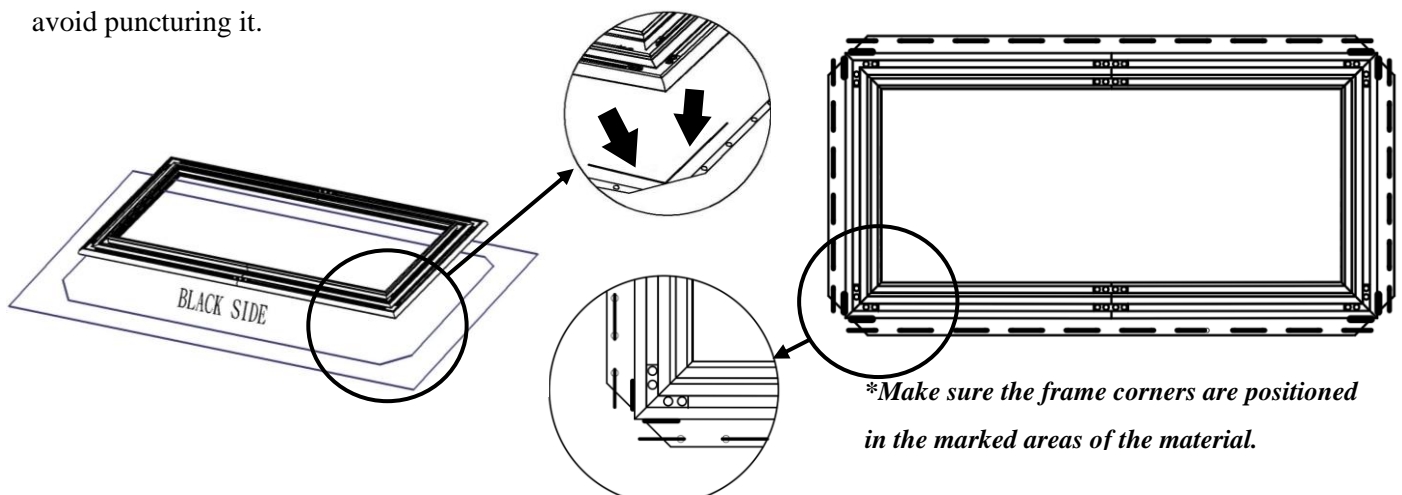

Center Support Bar

Step 9: Insert the *Center Support Bar (o)* into the upper top groove on the back of the frame with the bottom end near the approximate center point of the frame and rotate it in at an angle so that both ends of the bar are in alignment with the groove.

Diagonal Sizes of 150" and below use 1 x Center Support Bar

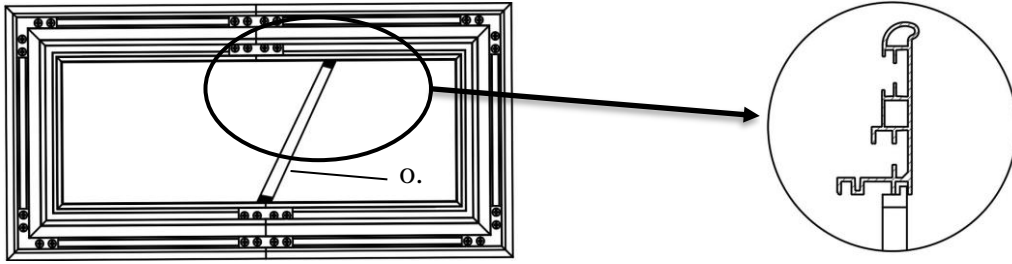

Diagonal Models above 150" require 2 x Center Support Bars

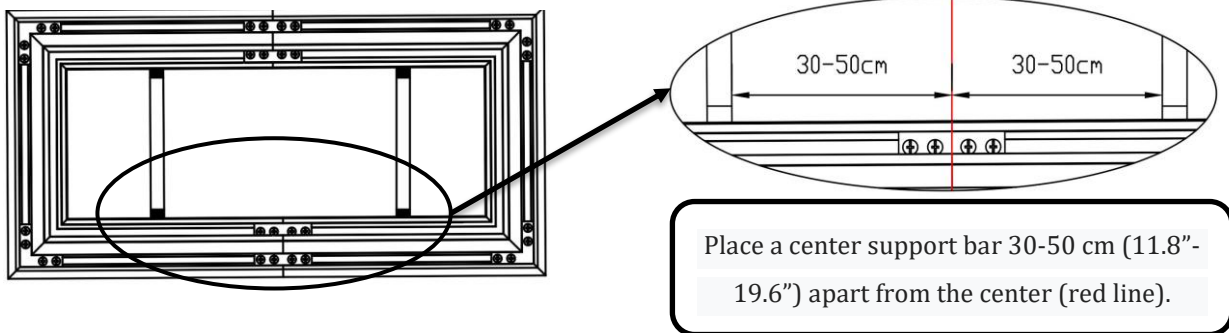

Attention: Do not proceed with the Edge Trim installation until making sure there are no ripples in the material.

Step 10: Hook one end of the spring and secure inside the groove of the frame, use the *spring hook (i)* to attach the spring to the grommet hole located on the screen material's outer edge in the following order.

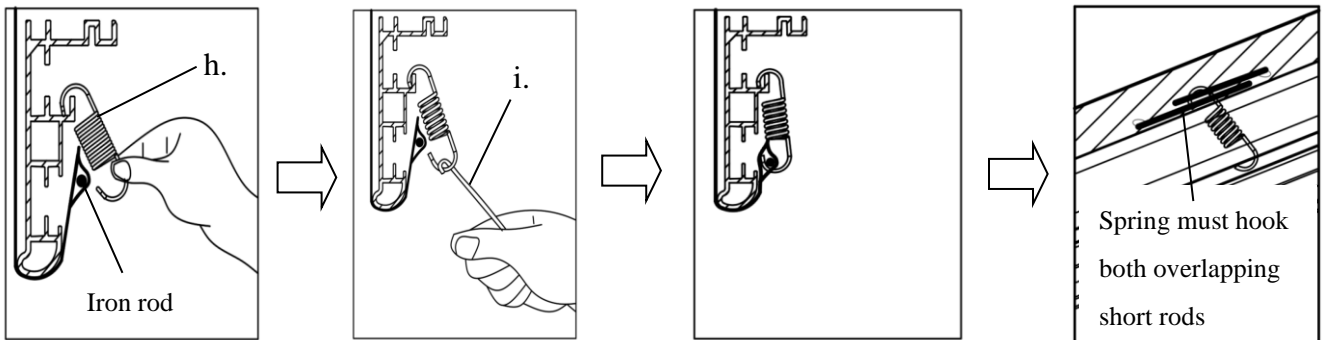

Begin by first attaching the center points on both vertical (left/right) sides, *steps 1-2*. Then the center points on both horizontal (top/bottom) sides, *steps 3-4*. Once all center points have been secured, make sure the screen material is still within the marked areas before proceeding to attach the next springs.

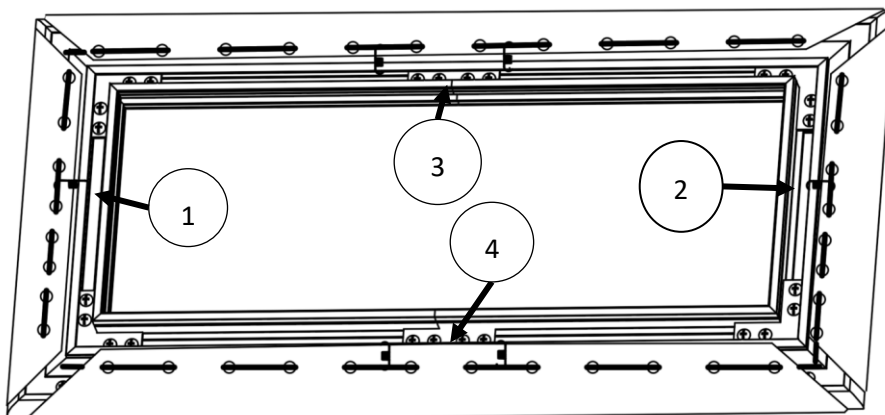

Continue attaching the rest of the springs to the material in the following order in *steps 5-12*.

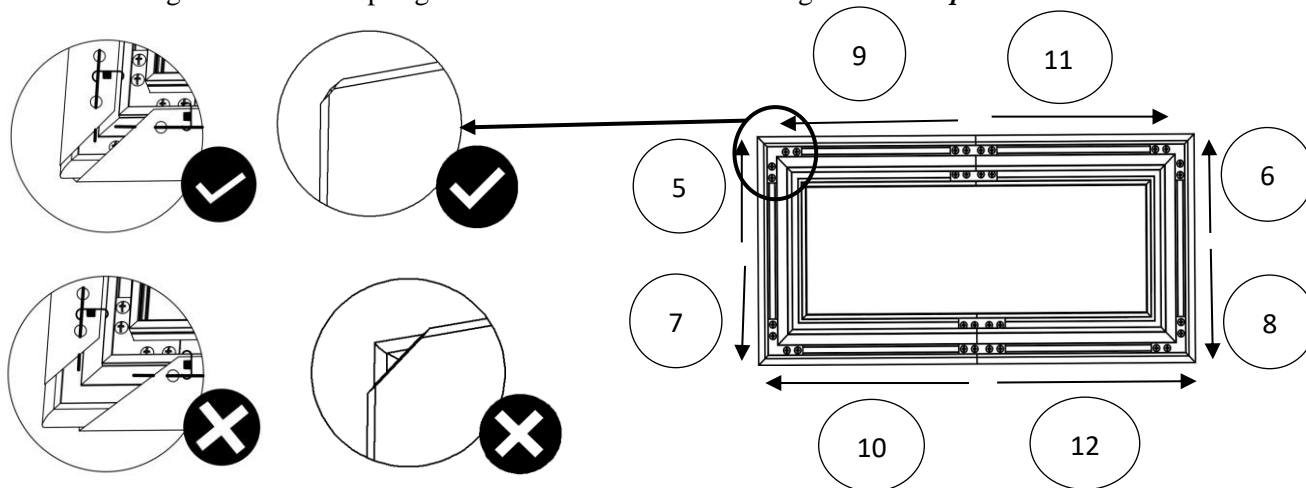

To avoid ripples forming in the material it is imperative that all of the corners are properly wrapped around the edges as illustrated in the check mark diagrams.

Note (after all springs have been attached):

Correct material installation –Corners of the screen material are properly wrapped around the corner edges of the frame and material is evenly tensioned and flat, creating a nicely taut surface.

Incorrect material installation –The corners of the screen material are not properly wrapped along the edge of the frame leaving the material with unbalanced tension and an uneven finish. To correct, detach springs from material at the corner(s) where material does not lie flat along the edge of the frame, reposition the material so that it lies flat and wraps along the edge of the frame, and reattach springs to the material.

Note: Please make note of the yellow label and spring in the center of the frame. This is an indicator to start the screen material installation process from the middle area of the frame.

How to avoid getting ripples on the screen’s material surface

Solution: Pull and smooth out the material using your hand from the center to the corners, creating a nicely taut surface as shown below.

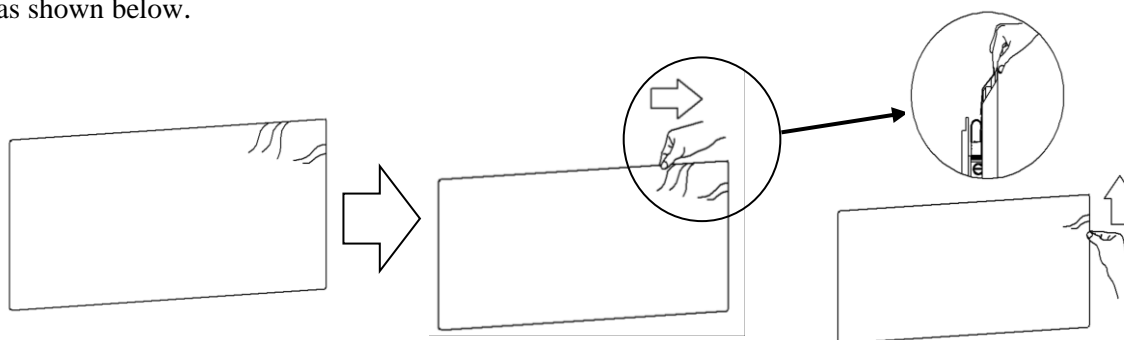

Edge Trim Installation

ATTENTION: THE TOP EDGE TRIM PIECE WITH THE LOGO SHOULD BE INSTALLED ON THE TOP.

Step 11: Place the edge trim frame pieces over each end of the frame.

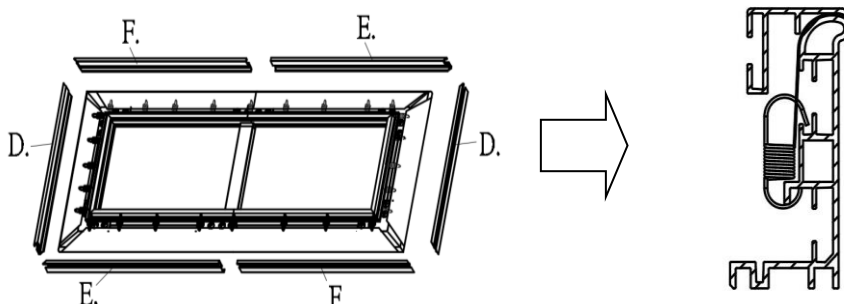

Connect edge trim frames (*e/f*) together using the *Center Joints- M4(a)* and secure with four of the *M4x4 Screws (m)* as shown in *Step 1*. Repeat for other side.

Once both top and bottom edge trim frames have been connected, attach the vertical (left/right) sides edge trim frames (*d*) using the Elbow Joints M4(c) and secure with four *M4x4 screws (m)* on all corners, *Step 2*.

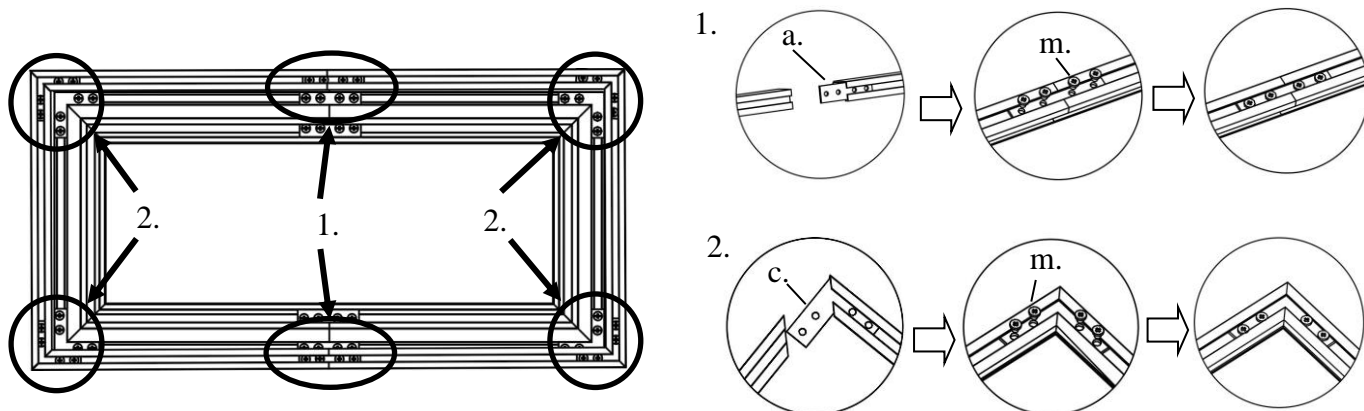

Step 12: Install the *angle cover (n)* on each corner of the frame as show in the illustration below.

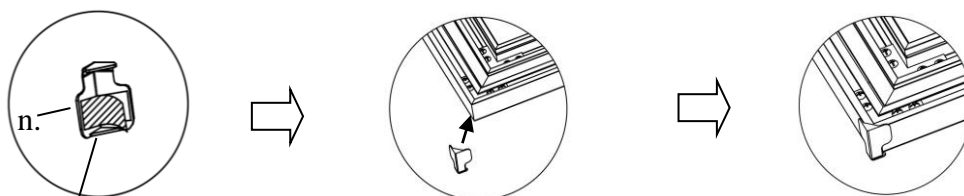

Peel off the double-sided tape.

Step 13: Install the *springs (q)* in each middle area to secure the bezel trim edge frame.

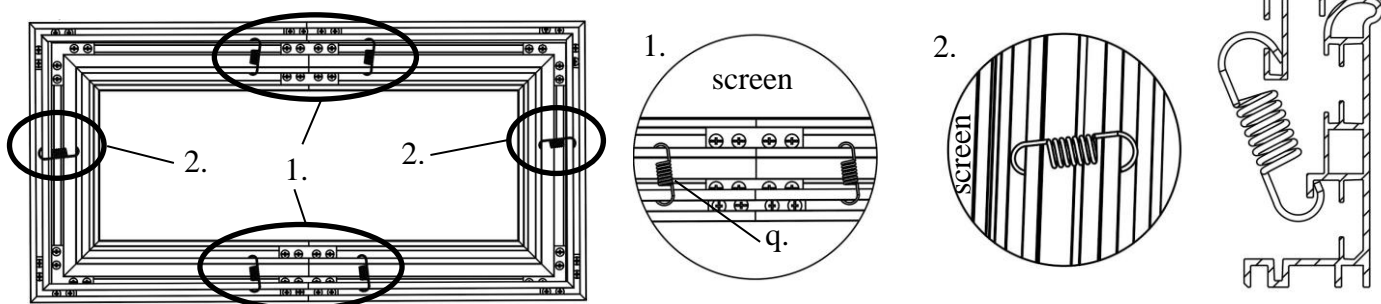

Wall Installation

Step 14: Measure the overall length and height of the frame and drill holes for the top brackets. Line up the wall brackets with the drilled holes on the installation location and screw them in using a Phillips screwdriver. If not installing into a structural wood stud, use a hollow wall anchor then screw in the M5x50 wood screws with a screwdriver. Make sure the brackets are leveled.

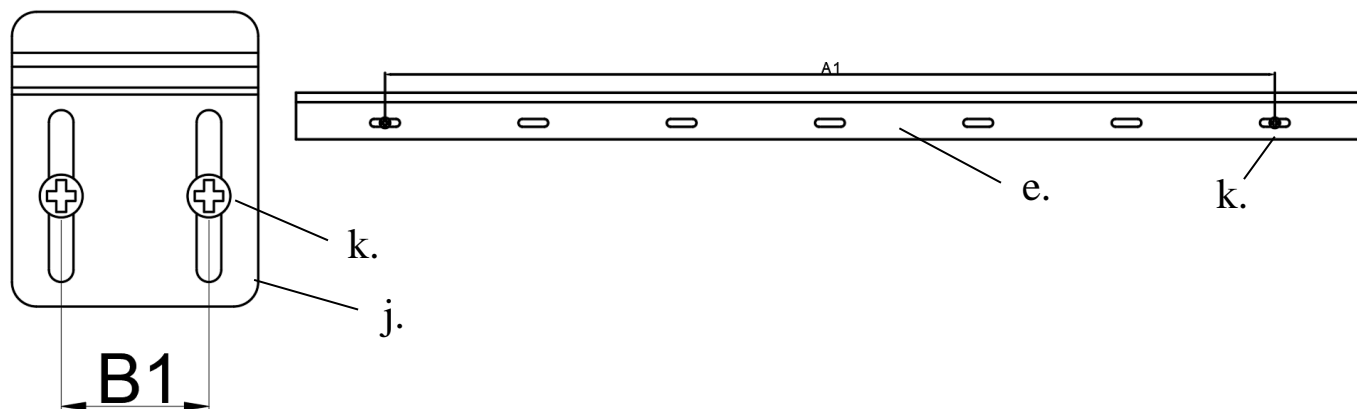

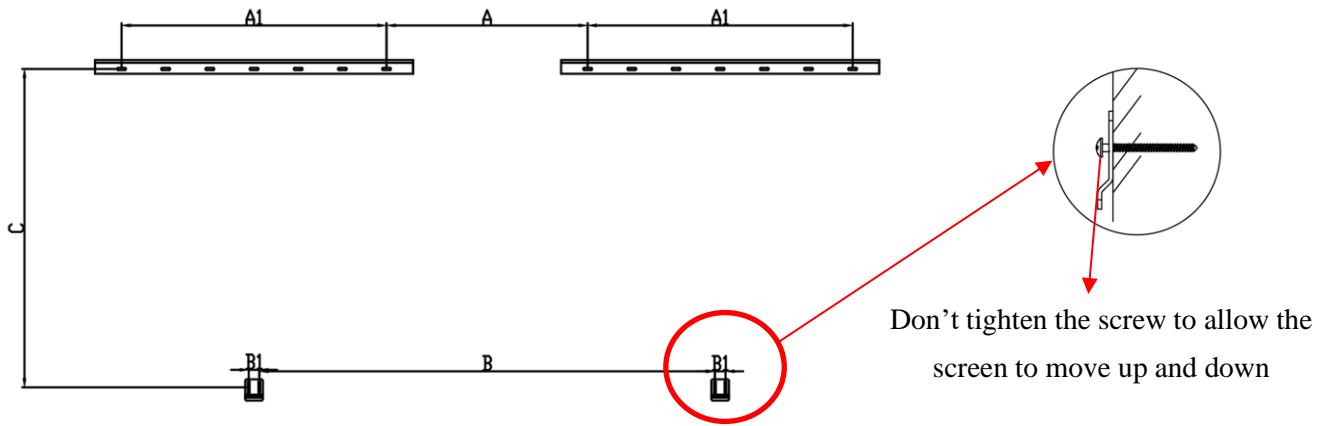

Model/Size	A = Top Wall bracket distance	A1 = Bracket hole distance	B = Bottom Wall bracket distance	B1 = Bracket hole distance	C = Top/Bottom Wall Bracket Height
120"	590mm (23.23")	750mm (29.53")	1340mm (52.76")	30mm (1.18")	1320mm (51.97")
135"	760mm (29.92")	750mm (29.53")	1500mm (59.06")	30mm (1.18")	1510mm (59.45")

Step 15: Position the fixed frame screen on the bottom bracket (fig. 1), lift and secure on the top wall bracket, then push down at the center of the top of the frame (fig. 2) to secure.

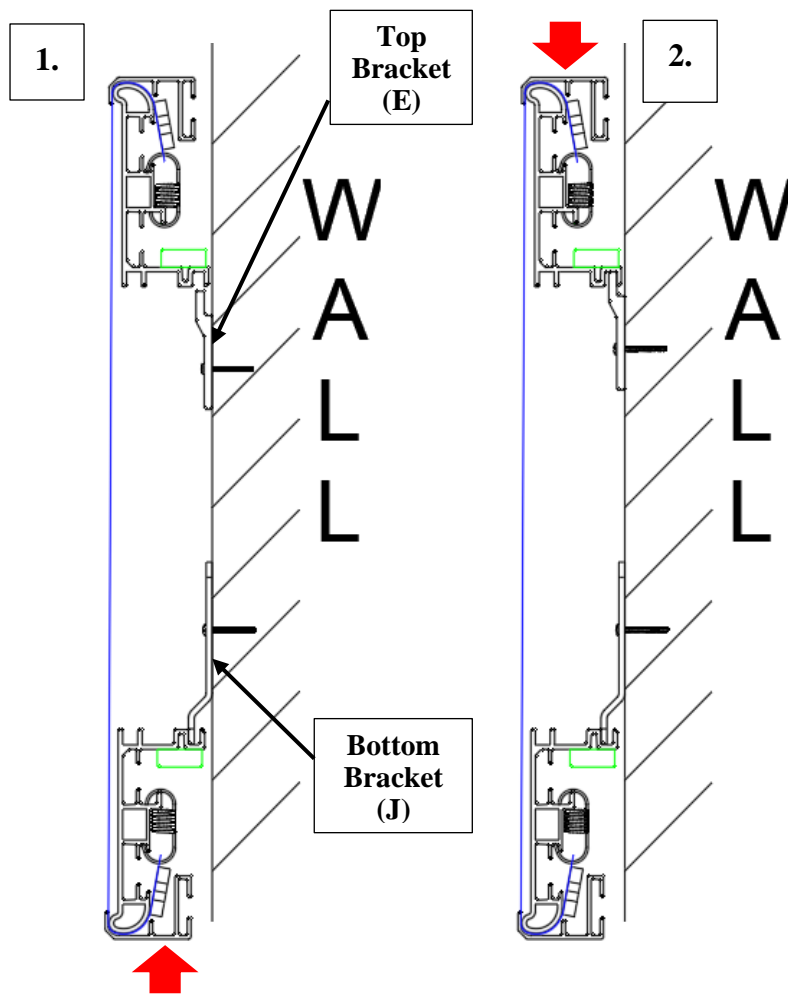

For Technical Support or an Elite Prime Vision contact in your area, visit

www.epvscreens.com