

DLP® Projector

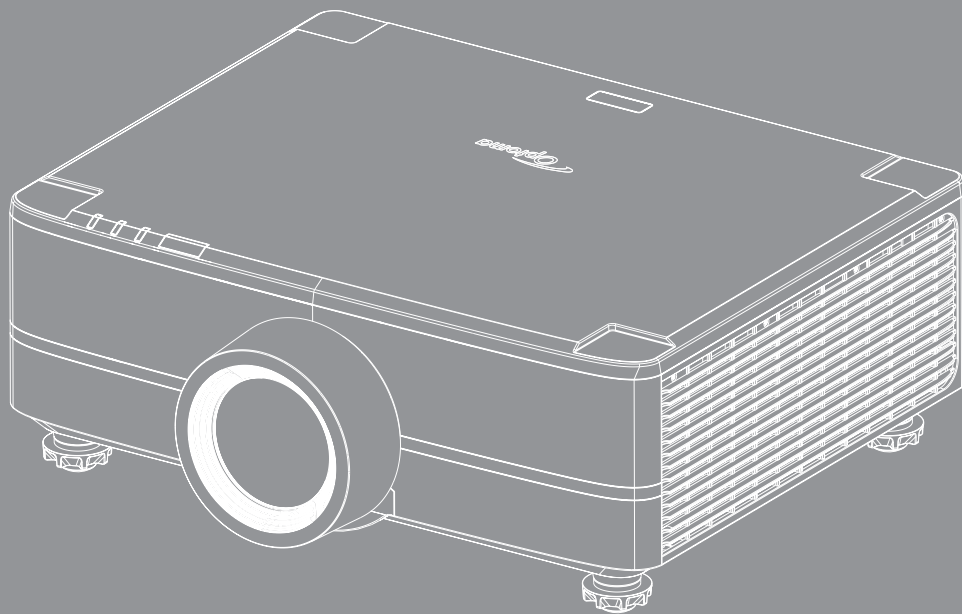



TABLE OF CONTENTS

SAFETY	4
<i>Important Safety Instruction</i>	4
<i>Cleaning the Lens</i>	5
<i>Laser Safety Information</i>	6
<i>3D Safety Information</i>	7
<i>Copyright</i>	7
<i>Disclaimer</i>	7
<i>Trademark Recognition</i>	8
<i>FCC Notice</i>	8
<i>Declaration of Conformity for EU countries</i>	8
<i>WEEE</i>	9
INTRODUCTION	10
<i>Package Overview</i>	10
<i>Standard Accessories</i>	10
<i>Product Overview</i>	11
<i>Connections</i>	12
<i>Keypad</i>	13
<i>Remote control</i>	14
SETUP AND INSTALLATION	16
<i>Connecting Sources to the Projector</i>	16
<i>Adjusting the Projector Image</i>	17
<i>Adjusting the Projection Image Shift</i>	18
<i>Adjusting the Projector's Zoom and Focus</i>	21
<i>Adjusting the Projector Position</i>	22
<i>Remote Setup</i>	23
USING THE PROJECTOR	25
<i>Powering On / Off the Projector</i>	25
<i>Menu navigation and features</i>	27
<i>OSD menu tree</i>	28
<i>Image menu</i>	42
<i>Display menu</i>	47
<i>Input Settings menu</i>	54
<i>Device Setup menu</i>	55
<i>Communication menu</i>	61
<i>Info menu</i>	66

ADDITIONAL INFORMATION..... 67

<i>Compatible Resolutions.....</i>	<i>67</i>
<i>RS232 Port Setting and Signals Connection.....</i>	<i>70</i>
<i>Image Size and Projection Distance.....</i>	<i>71</i>
<i>Ceiling Mount Installation</i>	<i>73</i>
<i>IR remote codes</i>	<i>74</i>
<i>Troubleshooting.....</i>	<i>76</i>
<i>LED Indicators and Lightning Messages.....</i>	<i>77</i>
<i>Specifications</i>	<i>78</i>
<i>RS232 protocol function list.....</i>	<i>79</i>
<i>Optoma global offices.....</i>	<i>88</i>

SAFETY

	The lightning flash with arrow head within an equilateral triangle is intended to alert the user to the presence of uninsulated "dangerous voltage" within the product's enclosure that may be of sufficient magnitude to constitute a risk of electric shock to persons.
	The exclamation point within an equilateral triangle is intended to alert the user to the presence of important operating and maintenance (servicing) instructions in the literature accompanying the appliance.

This product is herewith confirmed to comply with the requirements set out in the Council Directives on the Approximation of the laws of the Member States relating to Electromagnetic Compatibility Directive 2004/108/EEC.



Warning

- This product must not be used in residential areas.
- This product may cause interference if used in residential areas.

Such use must be avoided unless the user takes special measures to reduce electromagnetic emissions to prevent interference to the reception of radio and television broadcasts.

Important Safety Instruction



- Do not stare into the beam, RG2.
As with any bright source, do not stare into the direct beam, RG2 IEC 62471-5:2015.
- Do not block any ventilation openings. To ensure reliable operation of the projector and to protect from overheating, it is recommended to install the projector in a location that does not block ventilation. As an example, do not place the projector on a crowded surface. Do not put the projector in an enclosure such as a book case or a cabinet that restricts air flow.
- To reduce the risk of fire and/or electric shock, do not expose the projector to rain or moisture. Do not install near heat sources such as radiators, heaters, stoves or any other apparatus such as amplifiers that emits heat.
- Do not let objects or liquids enter the projector. They may touch dangerous voltage points and short out parts that could result in fire or electric shock.
- Do not use under the following conditions:
 - In extremely hot, cold or humid environments.
 - (i) Ensure that the ambient room temperature is within 5°C ~ 40°C (41°F ~ 104°F)
 - (ii) Relative humidity is 10% ~ 85%
 - In areas susceptible to excessive dust and dirt.
 - Near any appliance generating a strong magnetic field.
 - In direct sunlight.
- Do not use the unit if it has been physically damaged or abused. Physical damage/abuse would be (but not limited to):
 - Unit has been dropped.
 - Power supply cord or plug has been damaged.
 - Liquid has been spilled on to the projector.
 - Projector has been exposed to rain or moisture.
 - Something has fallen in the projector or something is loose inside.

- Do not place the projector on an unstable surface. The projector may fall over resulting in injury or the projector may become damaged.
- Do not block the light coming out of the projector lens when in operation. The light will heat the object and could melt, cause burns or start a fire.
- Please do not open or disassemble the projector as this may cause electric shock.
- Do not attempt to service the unit yourself. Opening or removing covers may expose you to dangerous voltages or other hazards. Please call Optoma before you send the unit for repair.
- See projector enclosure for safety related markings.
- The unit should only be repaired by appropriate service personnel.
- Only use attachments/accessories specified by the manufacturer.
- Do not look straight into the projector lens during operation. The bright light may harm your eyes.
- When switching the projector off, please ensure the cooling cycle has been completed before disconnecting power. Allow 90 seconds for the projector to cool down.
- Turn off and unplug the power plug from the AC outlet before cleaning the product.
- Use a soft dry cloth with mild detergent to clean the display housing. Do not use abrasive cleaners, waxes or solvents to clean the unit.
- Disconnect the power plug from the AC outlet if the product will not be used for a long period of time.
- Do not setup the projector in places where it might be subjected to vibration or shock.
- Do not touch the lens with bare hands.
- Remove battery/batteries from remote control before storage. If the battery/batteries are left in the remote for long periods, they may leak.
- Do not use or store the projector in places where smoke from oil or cigarettes may be present, as it can adversely affect the quality of the projector performance.
- Please follow the correct projector orientation installation as non standard installation may affect the projector performance.
- Use a power strip and/or surge protector. As power outages and brown-outs can KILL devices.

Cleaning the Lens

- Before cleaning the lens, be sure to turn off the projector and unplug the power cord to allow it to completely cool down.
- Use a compressed air tank to remove the dust.
- Use a special cloth for cleaning lens and gently wipe the lens. Do not touch the lens with your fingers.
- Do not use alkaline/acid detergents or volatile solvents such as alcohol for cleaning lens. If the lens is damaged due to the cleaning process, it is not covered by the warranty.



Warning

- Do not use a spray containing flammable gases to remove dust or dirt from the lens. This may cause a fire due to excessive heat inside the projector.
- Do not clean the lens if the projector is warming up as this may cause the lens' surface film to peel off.
- Do not wipe or tap the lens with a hard object.
- MOUNT ABOVE THE HEADS OF CHILDREN. The use of a ceiling mount is recommended with this product to place it above the eyes of children.

“WARNING: MOUNT ABOVE THE HEADS OF CHILDREN.”
Additional warning against eye exposure for close exposures less than 1 m.
 “AVERTISSEMENT : INSTALLER AU-DESSUS DE LA TÊTE DES ENFANTS.”
 Avertissement supplémentaire contre l'exposition oculaire pour des expositions à une distance de moins de 1 m.
 “警告：安裝在高於孩童頭頂處”
 關於小於1 m 近距離眼睛暴露的附加警告
 「警告：安裝在高於兒童頭部處」
 針對1 m 以下近距離眼睛接觸的額外警告

Laser Safety Information

- Complies with 21 CFR 1040.10 and 1040.11 except for conformance as a Risk Group 2 LIP as defined in IEC 62471-5:Ed. 1.0. For more information see Laser Notice No. 57, dated May 8, 2019. IEC 60825-1:2014: CLASS 1 LASER PRODUCT - RISK GROUP 2

	<p>IEC/EN 60825-1:2014 CLASS 1 LASER PRODUCT RISK GROUP 2 Complies with 21 CFR 1040.10 and 1040.11 except for conformance as a Risk Group 2 LIP as defined in IEC 62471-5:Ed. 1.0. For more information see Laser Notice No. 57, dated May 8, 2019.</p>
	<p>IEC/EN 60825-1:2014 PRODUIT LASER DE CLASSE 1 GROUPE DE RISQUE 2 Conforme aux normes 21 CFR 1040.10 et 1040.11, à l'exception de la conformité en tant que LIP du groupe de risque 2 définie dans la CEI 62471-5: Ed. 1.0. Pour plus d'informations, voir l'avis au laser n° 57 du 8 mai 2019.</p>
	<p>IEC/EN 60825-1:2014 1類激光產品RG2危險等級 除了IEC 62471-5:Ed.1.0中定義的RG2 LIP 危險等級以外，要符合21 CFR 1040.10和1040.11，更多相關資訊，請參閱2019年5月8日的第57號激光公告。</p>
	<p>IEC/EN 60825-1:2014 1類激光產品RG2危險等級 除了IEC 62471-5:Ed.1.0中定義的RG2 LIP 危險等級以外，要符合21 CFR 1040.10和1040.11，更多相關資訊，請參閱2019年5月8日的第57號激光公告。</p>

- This projector has built-in Class 4 laser module. Disassembly or modification is very dangerous and should never be attempted.
- Any operation or adjustment not specifically instructed by the user's guide creates the risk of hazardous laser radiation exposure.
- Do not open or disassemble the projector as this may cause damage by the exposure of laser radiation.
- Do not stare into beam when the projector is on. The bright light may result in permanent eye damage.
- When turning on the projector, make sure no one within projection range is looking at the lens.
- Without following the control, adjustment or operation procedure may cause damage by the exposure of laser radiation.
- Adequate instructions for assembly, operation, and maintenance, including clear warnings concerning precautions to avoid possible exposure to laser and collateral radiation in excess of the accessible emission limits in Class 2.
- The Class A digital apparatus meets all requirements of the Canadian Interference-Causing Equipment Regulation. Interference-Causing Equipment Regulation.
- Cet appareil numérique de la class A respecte toutes les exigences du Règlement sur le matériel brouilleur du Canada.
- Notice is given to supervise children and to never allow them to stare into the projector beam at any distance from the projector.
- Notice is given to use caution when using the remote control for starting the projector while in front of the projection lens.
- Notice is given to the user to avoid the use of optical aids such as binoculars or telescopes inside the beam

3D Safety Information

Please follow all warnings and precautions as recommended before you or your child use the 3D function.



Warning

- Children and teenagers may be more susceptible to health issues associated with viewing in 3D and should be closely supervised when viewing these images.

Photosensitive Seizure Warning and Other Health Risks

- Some viewers may experience an epileptic seizure or stroke when exposed to certain flashing images or lights contained in certain Projector pictures or video games. If you suffer from, or have a family history of epilepsy or strokes, please consult with a medical specialist before using the 3D function.
- Even those without a personal or family history of epilepsy or stroke may have an undiagnosed condition that can cause photosensitive epileptic seizures.
- Pregnant women, the elderly, sufferers of serious medical conditions, those who are sleep deprived or under the influence of alcohol should avoid utilizing the unit's 3D functionality.
- If you experience any of the following symptoms, stop viewing 3D pictures immediately and consult a medical specialist: (1) altered vision; (2) lightheadedness; (3) dizziness; (4) involuntary movements such as eye or muscle twitching; (5) confusion; (6) nausea; (7) loss of awareness; (8) convulsions; (9) cramps; and/ or (10) disorientation. Children and teenagers may be more likely than adults to experience these symptoms. Parents should monitor their children and ask whether they are experiencing these symptoms.
- Watching 3D projection may also cause motion sickness, perceptual after effects, disorientation, eye strain and decreased postural stability. It is recommended that users take frequent breaks to lessen the potential of these effects. If your eyes show signs of fatigue or dryness or if you have any of the above symptoms, immediately discontinue use of this device and do not resume using it for at least thirty minutes after the symptoms have subsided.
- Watching 3D projection while sitting too close to the screen for an extended period of time may damage your eyesight. The ideal viewing distance should be at least three times the screen height. It is recommended that the viewer's eyes are level with the screen.
- Watching 3D projection while wearing 3D glasses for an extended period of time may cause a headache or fatigue. If you experience a headache, fatigue or dizziness, stop viewing the 3D projection and rest.
- Do not use the 3D glasses for any other purpose than for watching 3D projection.
- Wearing the 3D glasses for any other purpose (as general spectacles, sunglasses, protective goggles, etc.) may be physically harmful to you and may weaken your eyesight.
- Viewing in 3D projection may cause disorientation for some viewers. Accordingly, DO NOT place your 3D PROJECTOR near open stairwells, cables, balconies, or other objects that can be tripped over, run into, knocked down, broken or fallen over.

Copyright

This publication, including all photographs, illustrations and software, is protected under international copyright laws, with all rights reserved. Neither this manual, nor any of the material contained herein, may be reproduced without written consent of the author.

© Copyright 2022

Disclaimer

The information in this document is subject to change without notice. The manufacturer makes no representations or warranties with respect to the contents hereof and specifically disclaims any implied warranties of merchantability or fitness for any particular purpose. The manufacturer reserves the right to revise this publication and to make changes from time to time in the content hereof without obligation of the manufacturer to notify any person of such revision or changes.

Trademark Recognition

Kensington is a U.S. registered trademark of ACCO Brand Corporation with issued registrations and pending applications in other countries throughout the world.

HDMI, the HDMI Logo, and High-Definition Multimedia Interface are trademarks or registered trademarks of HDMI Licensing LLC in the United States and other countries.

DLP®, DLP Link and the DLP logo are registered trademarks of Texas Instruments and BrilliantColor™ is a trademark of Texas Instruments.

HDBaseT™ and the HDBaseT Alliance logo are trademarks of the HDBaseT Alliance.

All other product names used in this manual are the properties of their respective owners and are Acknowledged.

FCC Notice

This Equipment has been tested and found to comply with the limits for a Class A digital device, pursuant to part 15 of the FCC Rules. These limits are designed to provide reasonable protection against harmful interference when the equipment is operated in a commercial environment. This equipment generates, uses, and can radiate radio frequency energy and, if not installed and used in accordance with the instruction manual, may cause harmful interference to radio communications.

Operation of this equipment in a residential area is likely to cause harmful interference in which case the user will be required to correct the interference at his own expense.

Notice: Shielded cables

All connections to other computing devices must be made using shielded cables to maintain compliance with FCC regulations.

Caution

Changes or modifications not expressly approved by the manufacturer could void the user's authority, which is granted by the Federal Communications Commission, to operate this projector.

Operation Conditions

This device complies with Part 15 of the FCC Rules. Operation is subject to the following two conditions:

1. This device may not cause harmful interference and
2. This device must accept any interference received, including interference that may cause undesired operation.

Notice: Canadian users

This Class A digital apparatus complies with Canadian ICES-003.

Remarque à l'intention des utilisateurs canadiens

Cet appareil numérique de la classe A est conforme à la norme NMB-003 du Canada.

Declaration of Conformity for EU countries

- EMC Directive 2014/30/EC (including amendments)
- Low Voltage Directive 2014/35/EC
- RED 2014/53/EU (if product has RF function)

WEEE



Disposal instructions

Do not throw this electronic device into the trash when discarding. To minimize pollution and ensure utmost protection of the global environment, please recycle it.

CAUTION: This equipment is equipped with a three-pin grounding-type power plug. Do not remove the grounding pin on the power plug. This plug will only fit a grounding-type power outlet. This is a safety feature. If you are unable to insert the plug into the outlet, contact an electrician. Do not defeat the purpose of the grounding plug.

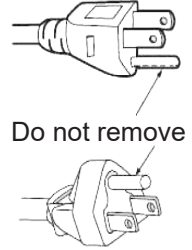

Do not remove



Warning: Do not remove the earthing pin on the mains plugs. This apparatus is equipped with a three prong earthing type mains plug. This plug will only fit an earthing-type mains socket. This is a safety feature. If you are unable to insert the plug into the mains socket, contact an electrician. Do not defeat the purpose of the earthing plug.

INTRODUCTION

Package Overview

Carefully unpack and verify that you have the items listed below under standard accessories. Some of the items under optional accessories may not be available depending on the model, specification and your region of purchase. Please check with your place of purchase. Some accessories may vary from region to region.

The warranty card is only supplied in some specific regions. Please consult your dealer for detailed information.

Standard Accessories

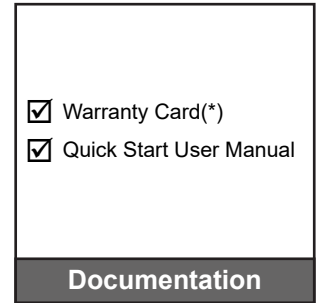
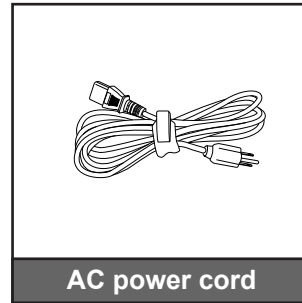
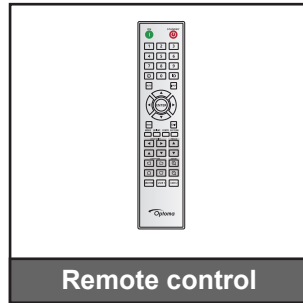
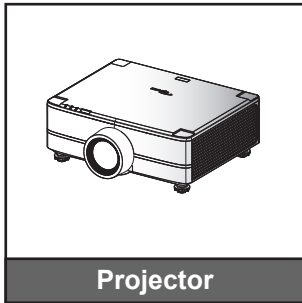

Note:

- The actual remote control may vary depending on the region.
- (*) For European warranty Information, please visit www.optoma.com.



Please scan the OPAM warranty QR code or visit the following URL:
<https://www.optoma.com/us/support/warranty-and-return-policy/>



Please scan the Asia-Pacific QR code or visit the following URL:
<https://www.optoma.com/support/download>

INTRODUCTION

Product Overview

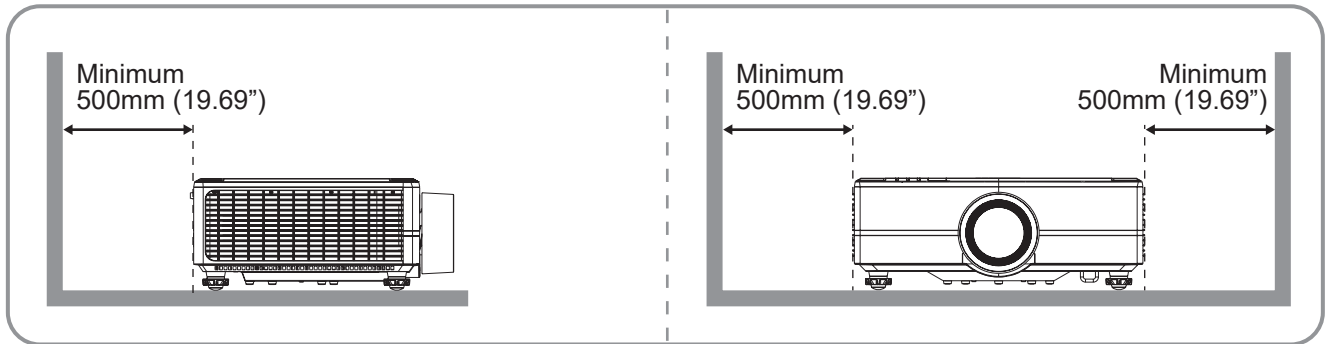
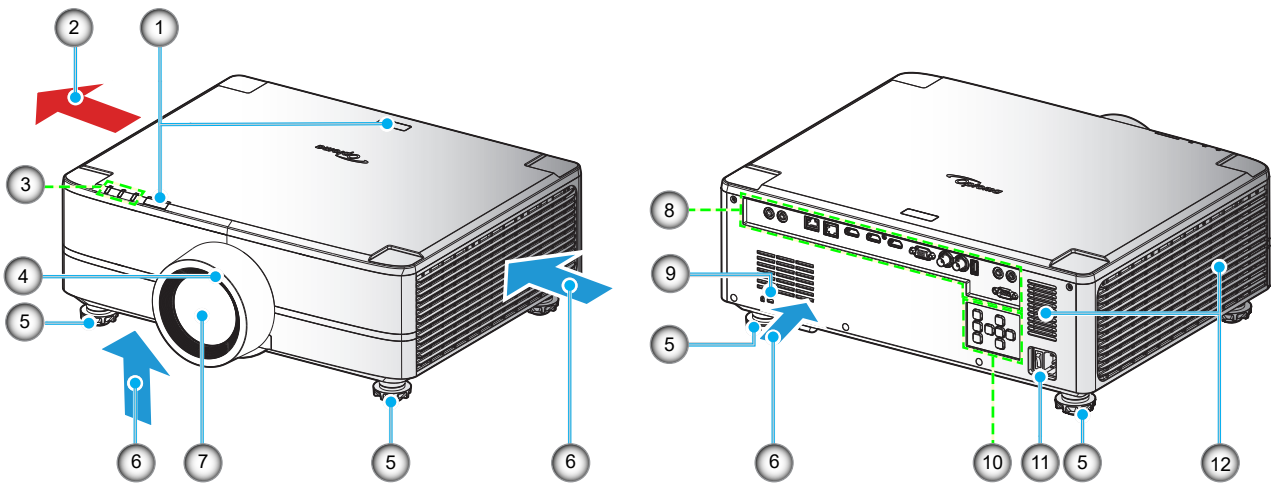

Note:

- Do not block projector intake and exhaust vents.
- When operating the projector in an enclosed space, allow at least 500mm (19.69") clearance around the intake and exhaust vents.

No.	Item	No.	Item
1.	IR Receiver	7.	Projection Lens
2.	Ventilation (Outlet)	8.	Input / Output
3.	LED Indicators	9.	Kensington™ Lock Port
4.	Deco Ring (1.6x lens / Fixed lens models)	10.	Control Panel
5.	Tilt-Adjustment Foot	11.	Power Socket / Power Switch
6.	Ventilation (Inlet)	12.	Speakers

INTRODUCTION

Connections

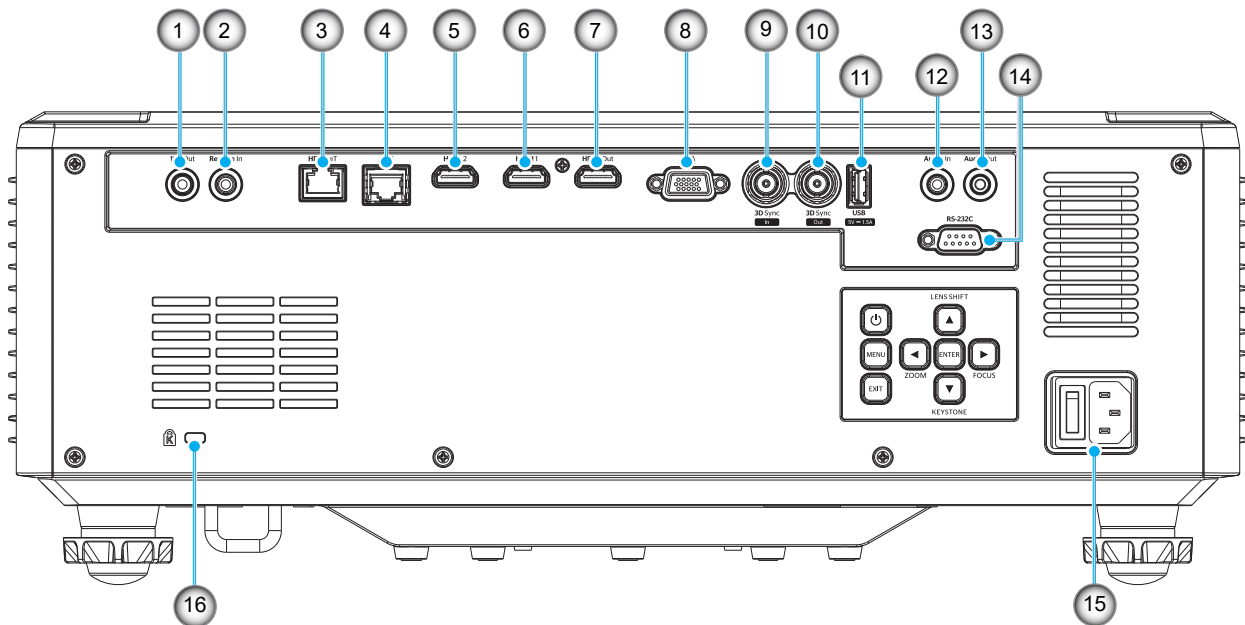

No.	Item	Cable	Example Connections ¹
1.	12V Out Connector	12V Trigger Cable	Motorized screen, Curtain, etc
2.	Remote In Connector	Wired Remote Control Cable or IR Receiver Cable (3.5mm TRS type ²)	RCU
3.	HDBaseT Connector	RJ-45 Cable	Media Play
4.	LAN Connector	RJ-45 Cable	Local or Company Network
5.	HDMI 2 Connector	HDMI Cable	Computer, Game, Console, Media Play
6.	HDMI 1 Connector	HDMI Cable	Computer, Game, Console, Media Play
7.	HDMI Out Connector	HDMI Cable	Screen
8.	VGA Connector	VGA Cable	Computer
9.	3D Sync In Connector	3D Sync Cable	Computer
10.	3D Sync Out Connector	3D Emitter Cable	3D Emitter
11.	USB Connector (Power 5V \rightarrow 1.5A) ³	USB (A to A) Cable	USB Flash Drive
12.	Audio In Connector	Audio In Cable	Media Play
13.	Audio Out Connector	Audio Out Cable	Speaker, Media Play
14.	RS-232C Connector	RS232 Cable	Computer
15.	Power Socket / Power Switch	Power Cord	Projector
16.	Kensington™ Lock Port	Protection Cable	Projector

Note:

1. These are just a few examples of what you can connect. There may be more options available for each port.
2. 3.5mm TRS type.

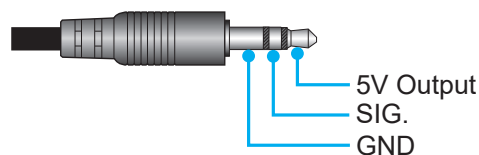

3. Not recommended for charging a cell phone.

INTRODUCTION

Keypad

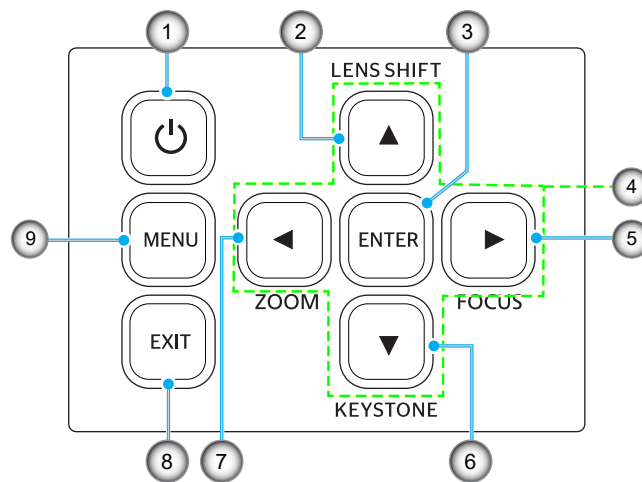

No.	Button	Function
1.	Power Button	Turns the projector on or off.
2.	Lens Shift	Adjust the lens vertical / horizontal position.
3.	Enter	Confirm the settings.
4.	Four Directional Select Keys	Navigation keys.
5.	Focus	Adjust the image focus.
6.	Keystone Correction	Adjust the keystone correction.
7.	Zoom	Adjust the image size.
8.	Exit	Returns to previous menu or exit menu if at top level.
9.	Menu	Shows the main menu on screen.

INTRODUCTION

Remote control

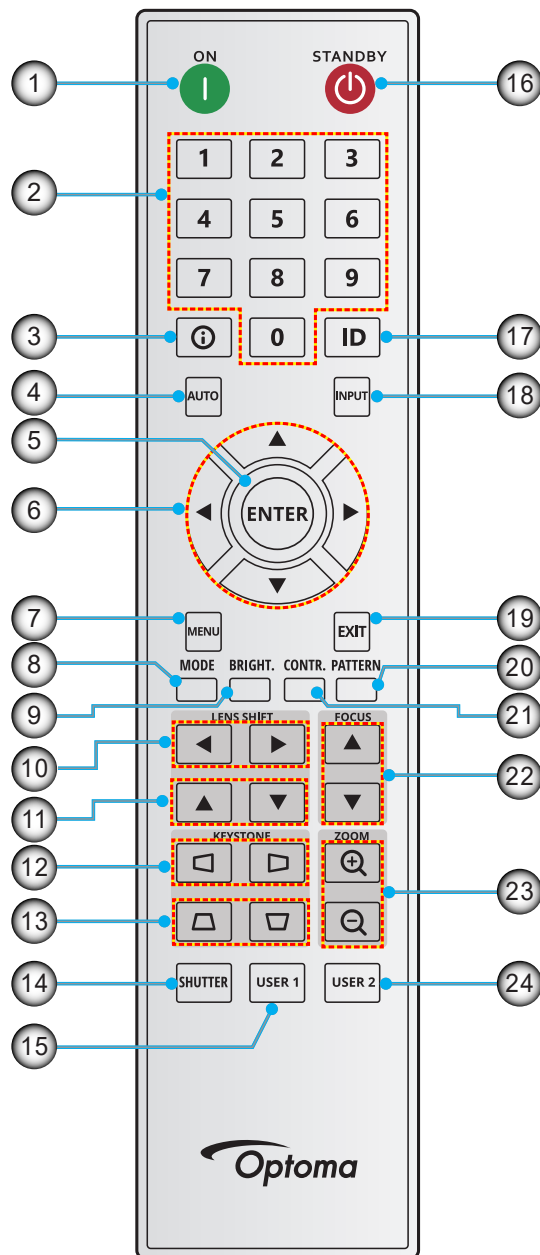

No.	Button	Function
1.	Power On	Turn the projector on.
2.	Number Keys	Input numbers (0-9).
3.	Info	Display information on the screen image.
4.	Auto	Automatically synchronize the projector to an input source.
5.	Enter	Press to confirm the selection.
6.	Arrow Keys	Use arrow keys to navigate through the menu or select the appropriate settings.
7.	Menu	Show the main menu on the screen.
8.	Mode	Press to select the preset display mode.
9.	Brightness	Set the brightness of the image.

INTRODUCTION

No.	Button	Function
10.	Left Shift (Horizontal)	Adjust the image position horizontally.
11.	Left Shift (Vertical)	Adjust the image position vertically.
12.	Keystone (Horizontal)	Adjust a horizontally keystone image.
13.	Keystone (Vertical)	Adjust a vertically keystone image.
14.	Shutter	Momentarily turn off/on the screen (AV Mute).
15.	User 1	Press to assign custom functions. See user guide for more info.
16.	Standby	Turn the projector off.
17.	ID	Set the projector address.
18.	Input	Select an input source manually.
19.	Exit	Back to previous menu.
20.	Pattern	Display test pattern.
21.	Contrast	Set the contrast of the image.
22.	Focus	Adjust the image focus.
23.	Zoom	Adjust the image size.
24.	User 2	Press to assign custom functions. See user guide for more info.

Note: Some keys may have no function for models that do not support these features.

SETUP AND INSTALLATION

Connecting Sources to the Projector

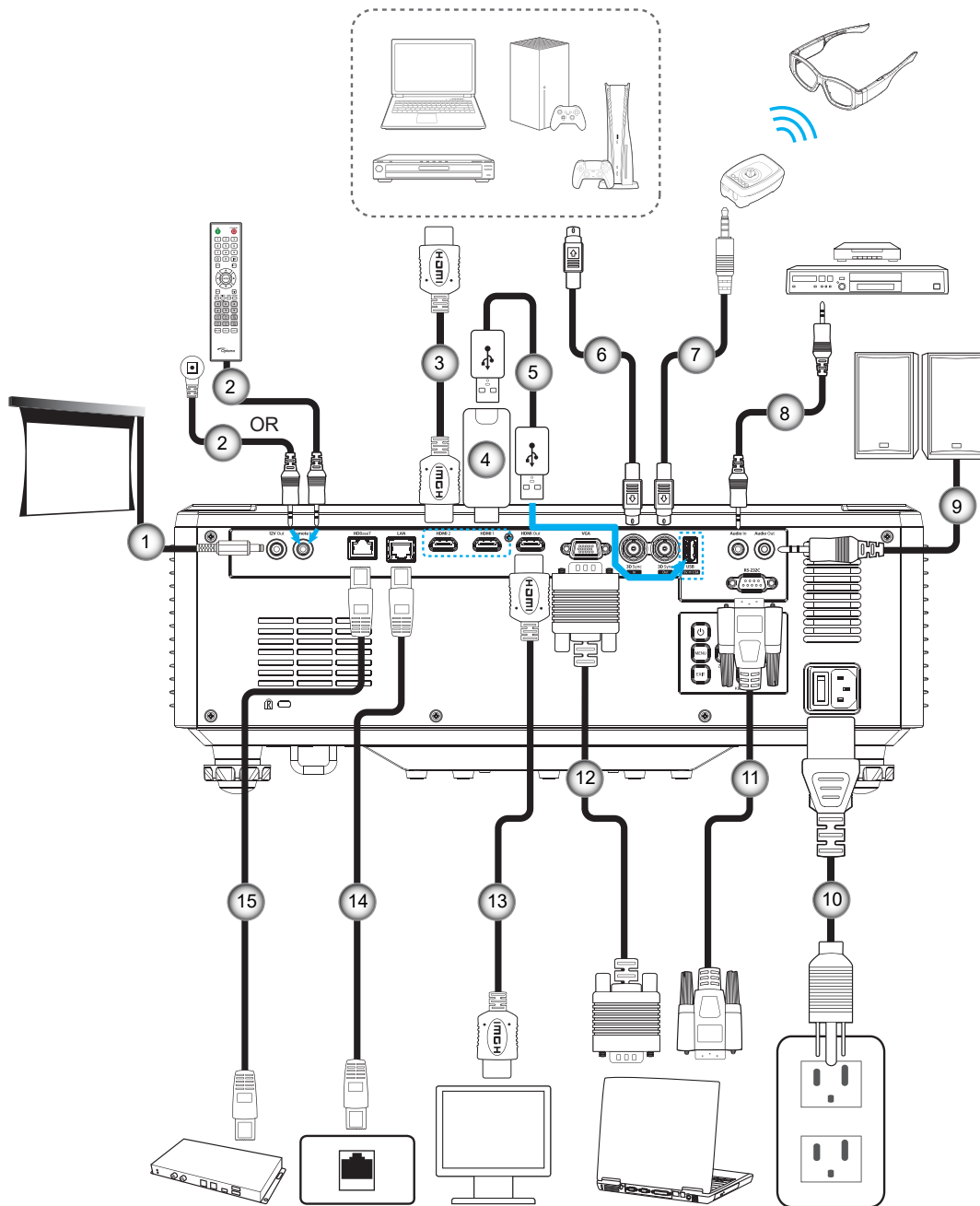

No.	Item
1.	12V DC Jack
2.	Wired Remote Control Cable or IR Receiver Cable (3.5mm TRS type)
3.	HDMI Cable
4.	HDMI Dongle
5.	USB (A to A) Cable

No.	Item
6.	3D Sync Cable
7.	3D Emitter Cable
8.	Audio In Cable
9.	Audio Out Cable
10.	Power Cord

No.	Item
11.	RS232 Cable
12.	VGA Cable
13.	HDMI Cable
14.	RJ-45 Cable
15.	RJ-45 Cable

SETUP AND INSTALLATION

Adjusting the Projector Image

Adjusting the Projector's Height

The projector is equipped with elevator feet for adjusting the image height.

1. Locate the adjustable foot you wish to adjust on the underside of the projector.
2. Rotate the adjustable foot clockwise or counterclockwise to raise or lower the projector.

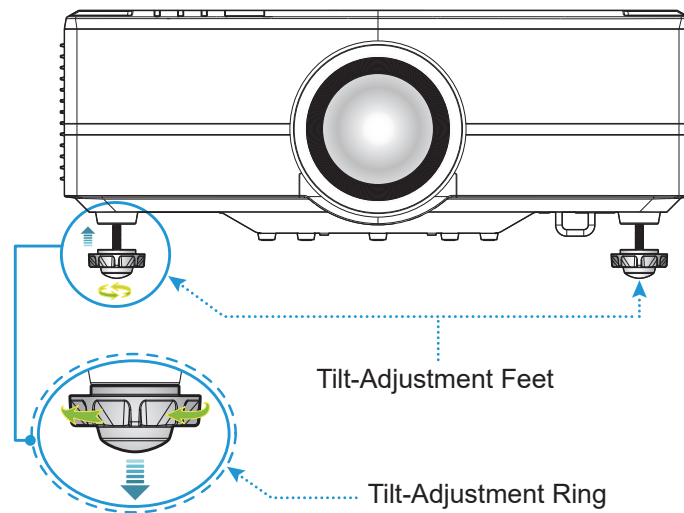

SETUP AND INSTALLATION

Adjusting the Projection Image Shift

The projection lens can be moved up, down, right, and left with the motor-driven lens shift function. This function makes the positioning of images easy on the screen. Lens shift is generally expressed as a percentage of the image height or width, see below illustration.

Vertical / Horizontal Lens Shift

When the lens is shifted to top:

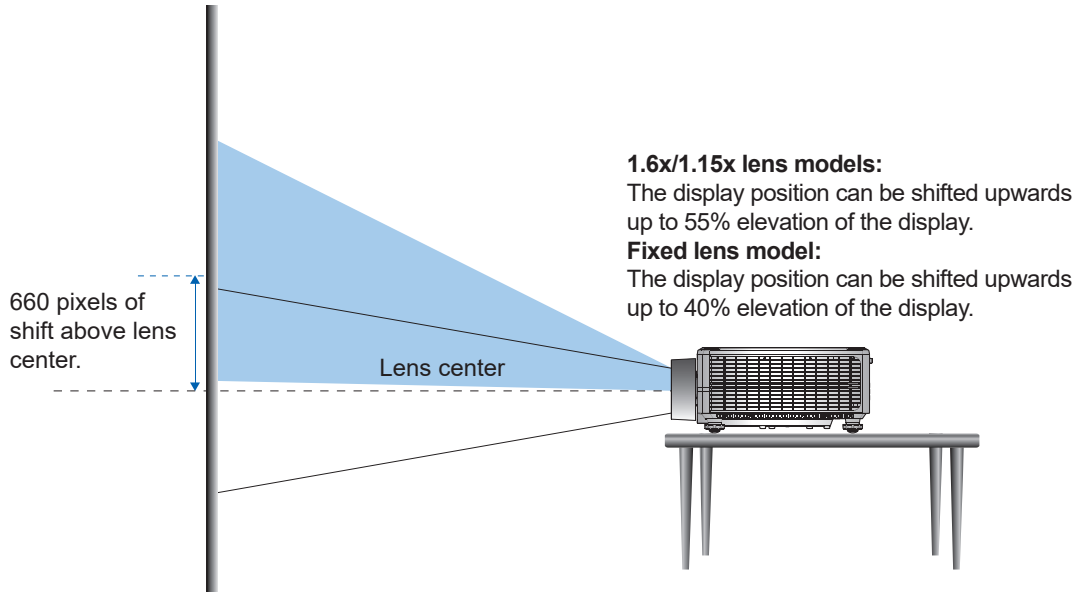

When the lens is shifted to bottom:

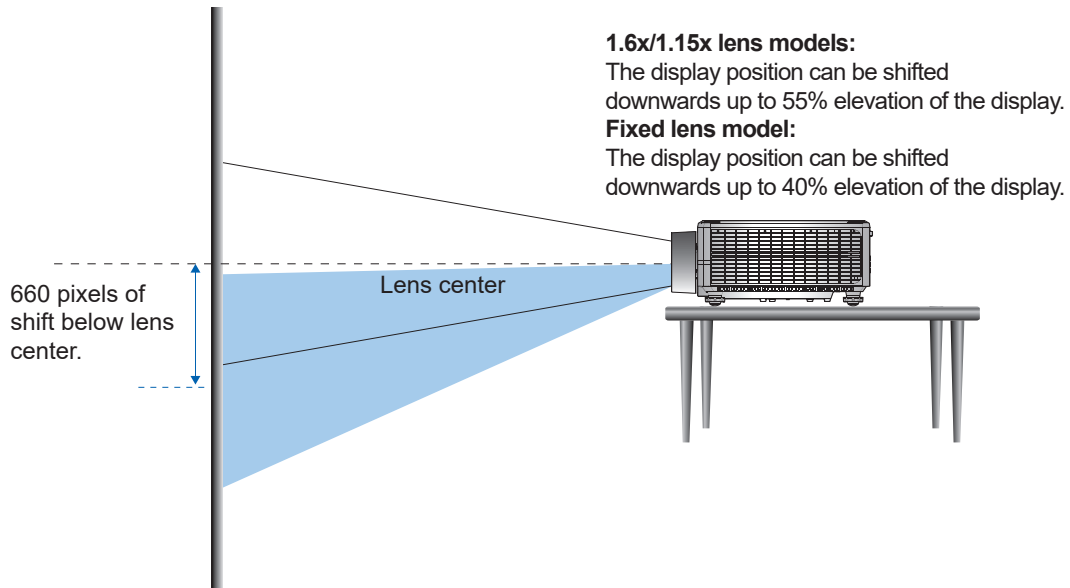

SETUP AND INSTALLATION

When the lens is shifted to the leftmost:

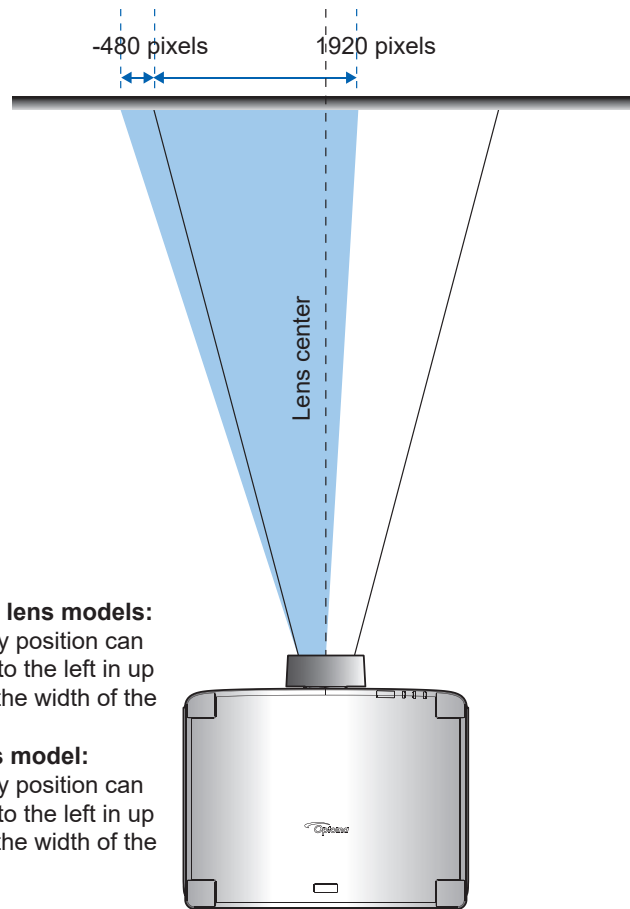

1.6x/1.15x lens models:

The display position can be shifted to the left in up to 25% of the width of the display.

Fixed lens model:

The display position can be shifted to the left in up to 18% of the width of the display.

When the lens is shifted to the rightmost:

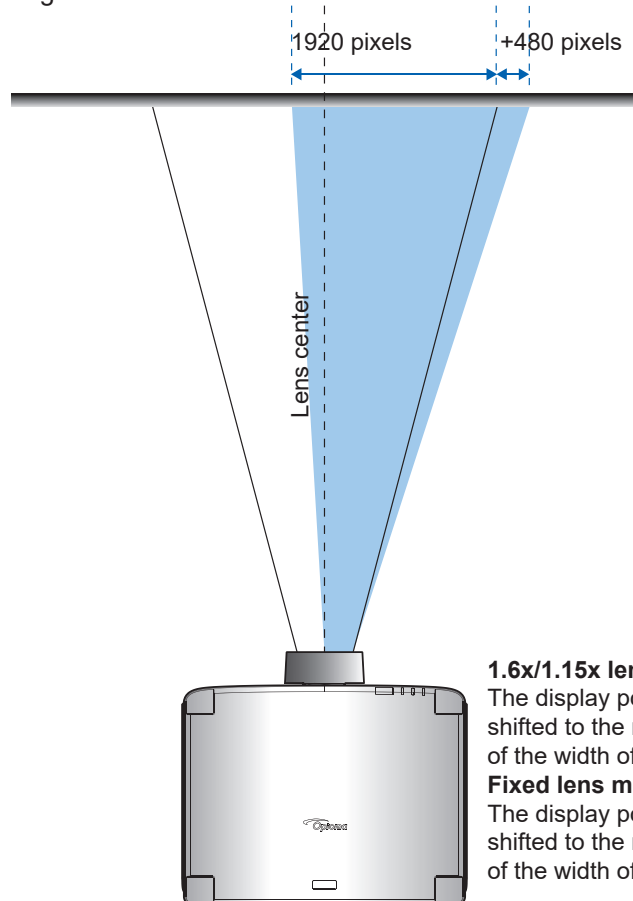

1.6x/1.15x lens models:

The display position can be shifted to the right in up to 25% of the width of the display.

Fixed lens model:

The display position can be shifted to the right in up to 18% of the width of the display.

SETUP AND INSTALLATION

Lens Shift Range

WUXGA	Lens Shift Range (1/2 image)			
	ΔH	ΔV	ΔH_0	ΔV_0
1.6x/1.15x lens models	50%	110%	10%	30%
Fixed lens model	36%	80%	0%	0%

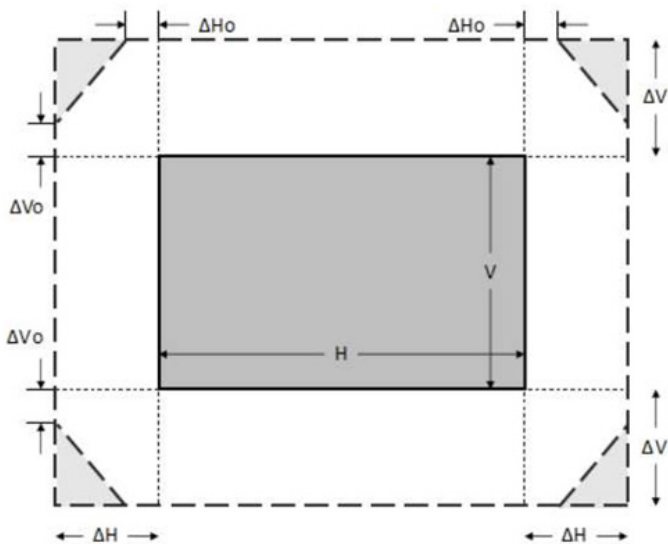

Note:

- ΔH : The lens shift range in horizontal direction when the lens is at the center.
- ΔV : The lens shift range in vertical direction when the lens is at the center.
- ΔH_0 : The lens shift range without vignetting in horizontal direction when the lens is at the top center or the bottom center.
- ΔV_0 : The lens shift range without vignetting in vertical direction when the lens is at the middle right or the middle left.

SETUP AND INSTALLATION

Adjusting the Projector's Zoom and Focus

Use the remote control or projector keypad to adjust the zoom and focus of the projected image.

- To adjust the image focus, press **Focus** and the ▲▼ buttons until the image is sharp and legible. **A**
- To adjust the image size, press **Zoom** and the 🔍🔍 buttons on the remote control or ◀▶ on the keypad to get the required image size. **B**

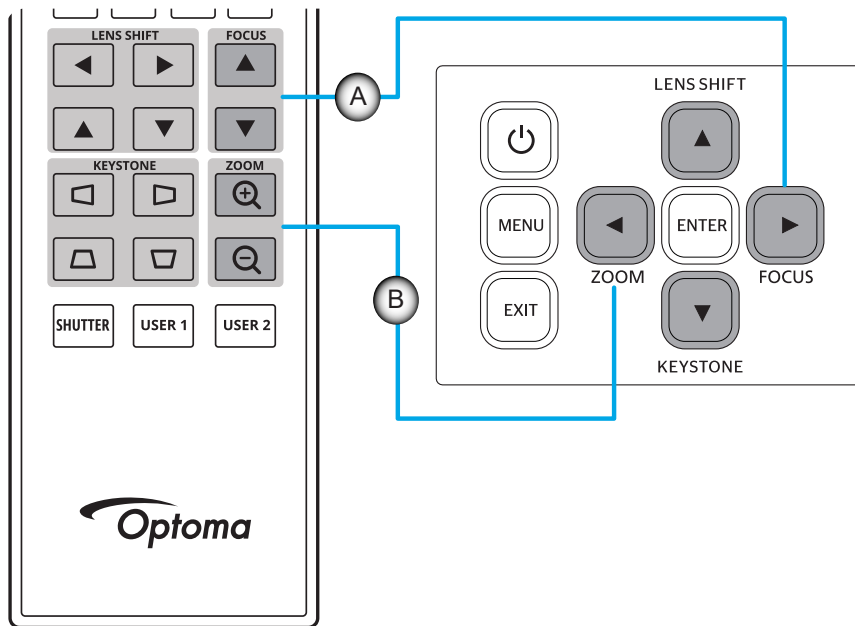

SETUP AND INSTALLATION

Adjusting the Projector Position

When you select a position for the projector, consider the size and shape of your screen, the location of your power outlets, and the distance between the projector and the rest of your equipment.

Follow these general guidelines:

- Position the projector on a flat surface at a right angle to the screen. The 1.6x/1.15x lens models projector (with the standard lens) must be at least 60 inch (1.52m) from the projection screen. The fixed lens model projector (with the standard lens) must be at least 40 inch (1.02m) from the projection screen.
- Position the projector to the desired distance from the screen. The distance from the lens of the projector to the screen, the zoom setting, and the video format determine the size of the projected image.
- Lens throw ratio:
1.6x lens model: 1.25 ~ 2.0
1.15x lens model: 0.65 ~ 0.75
Fixed lens model: 0.63
360 degrees free orientation operation.

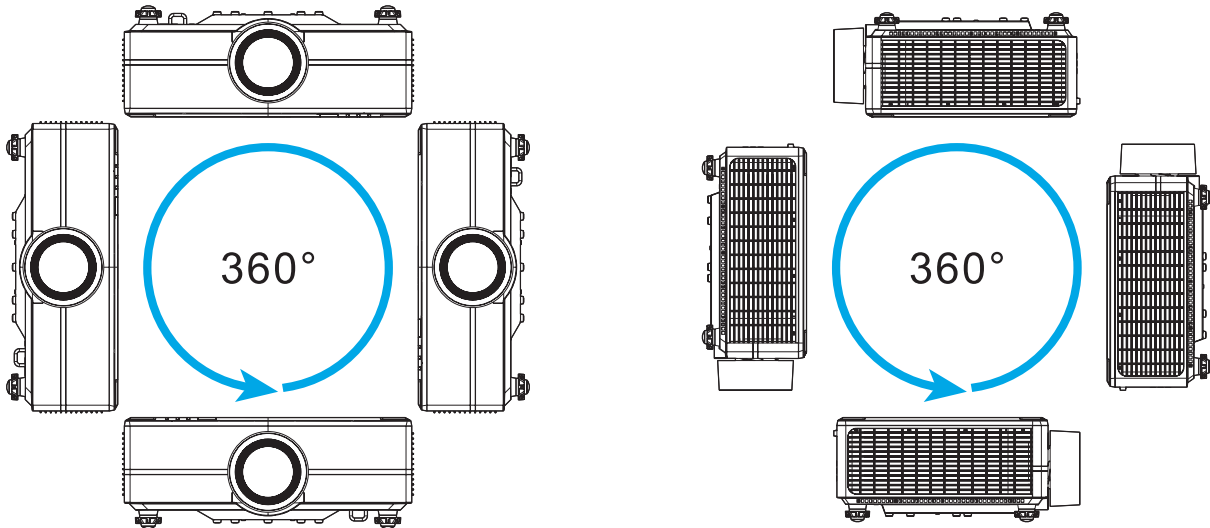

- When installing multiple projectors, keep at least 1000mm (39.4") space between the adjacent projectors.
- For ceiling/wall mount installations, make sure to leave 15 mm (0.6") between the ceiling mount and the bottom intake vents of the projector.

SETUP AND INSTALLATION

Remote Setup

Install / Replacing Remote Control Batteries

Two AAA size batteries are supplied for the remote control.

1. Remove the battery cover on the back of the remote control.
2. Insert AAA batteries in the battery compartment as illustrated.
3. Replace back cover on remote control.

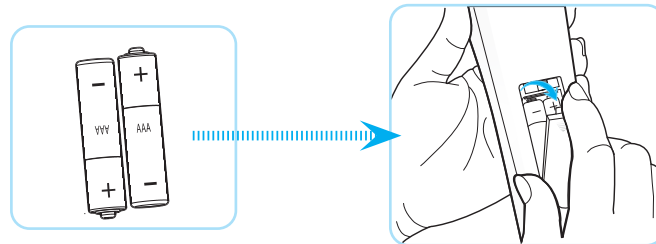

Note: Replace only with the same or equivalent type batteries.

CAUTION

Improper use of batteries can result in chemical leakage or explosion. Be sure to follow the instructions below.

- Do not mix batteries of different types. Different types of batteries have different characteristics.
- Do not mix old and new batteries. Mixing old and new batteries can shorten the life of new batteries or cause chemical leakage in old batteries.
- Remove batteries as soon as they are depleted. Chemicals that leak from batteries that come in contact with skin can cause a rash. If you find any chemical leakage, wipe thoroughly with a cloth.
- The batteries supplied with this product may have a shorter life expectancy due to storage conditions.
- If you will not be using the remote control for an extended period of time, remove the batteries.
- When you dispose of the batteries, you must obey the law in the relative area or country.

SETUP AND INSTALLATION

Remote Control Effective Range

Infra-Red (IR) remote control sensor is located on the top and front sides of the projector. Ensure to hold the remote control at an angle within 30 degrees perpendicular to the projector's IR remote control sensor to function correctly. The distance between the remote control and the sensor should not be longer than 20 meters (65.6 feet) when holding not longer than 30 meters (98.4 feet) when aiming the sensor at 0°.

- Make sure that there are no obstacles between the remote control and the IR sensor on the projector that might obstruct the infra-red beam.
- Make sure the IR transmitter of the projector/remote control is not being shined by sunlight or fluorescent lamps directly.
- Please keep the remote controller away from fluorescent lamps for over 2 m or the remote controller might become malfunction.
- If the remote control is close to Inverter-Type fluorescent lamps, it might become ineffective from time to time.
- If the remote control and the projector are within a very short distance, the remote control might become ineffective.
- When you aim at the screen, the effective distance is less than 5 m from the remote control to the screen and reflecting the IR beams back to the projector. However, the effective range might change according to screens.

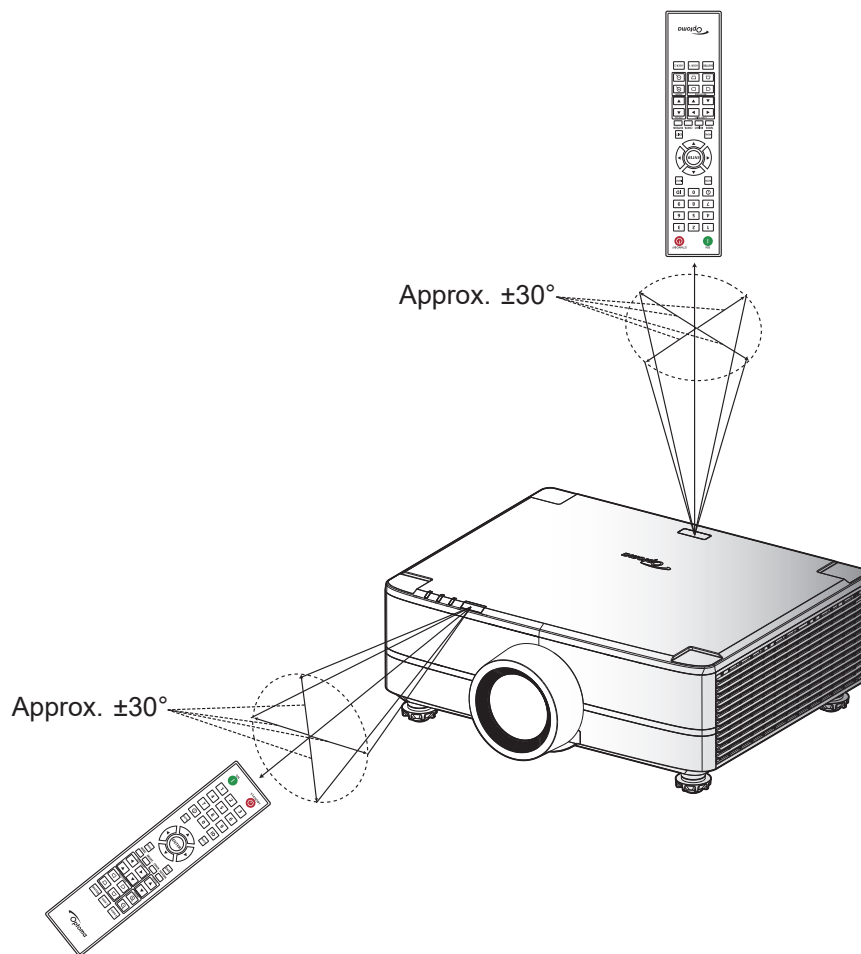

USING THE PROJECTOR

Powering On / Off the Projector

Powering On

1. Securely connect the power lead and signal/source cable. When connected, the power LED will turn red.
2. Set the power switch to the “I” (On) position and wait until the “⏻” button on the projector keypad is solid red.

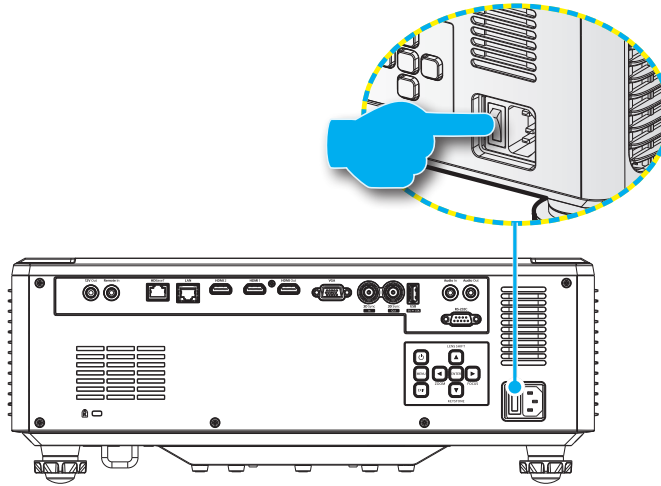

3. Turn on the projector by pressing the “⏻” button on the projector keypad or remote control. During startup the power LED is flashing red and during normal operation, the power LED is solid green.

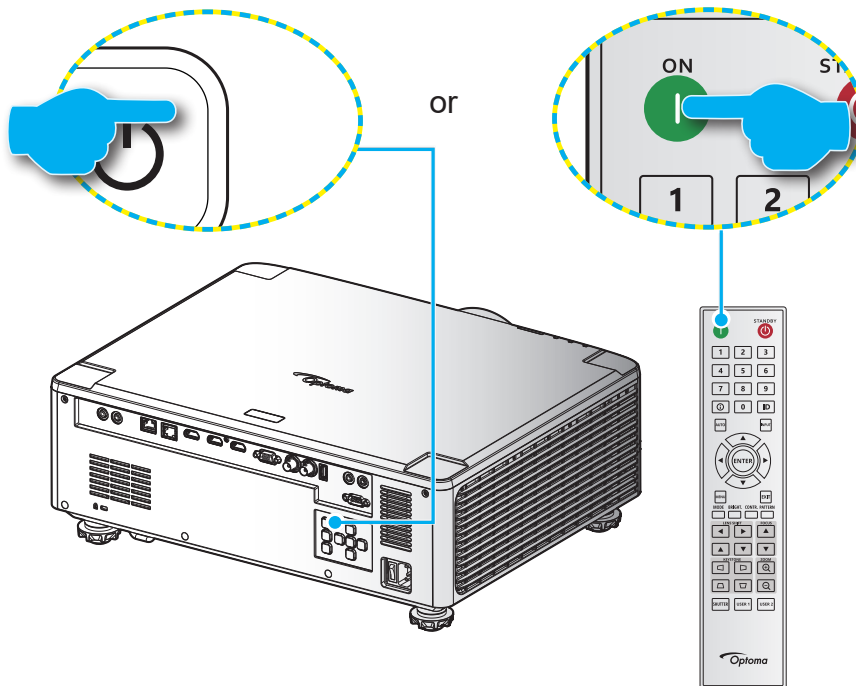

USING THE PROJECTOR

Powering Off

1. Turn off the projector by pressing the “⏻” button on the projector keypad or the | button on the remote control. The following message will be displayed:

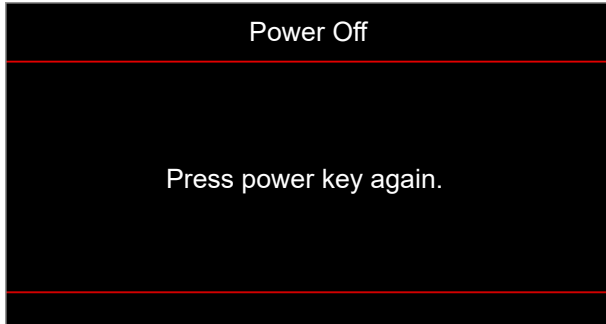

2. Press the ⏻ or | button again to confirm, otherwise the message will disappear after 15 seconds. When you press the ⏻ or | button for the second time, the projector will shut down.
3. During the cooling cycle, the power LED is flashing green. When the power LED turns solid red, this indicates the projector has entered standby mode. If you wish to turn the projector back on, you must wait until the cooling cycle has finished and the projector has entered standby mode. When the projector is in standby mode, simply press the “⏻” button on the projector or the remote control again to turn on the projector.
4. Disconnect the power cord from the electrical outlet and the projector.

Note:

- *It is not recommended that the projector is turned on immediately, right after a power off procedure.*
- *By default, the projector turns off automatically after 20 minutes of inactivity. You can modify the idle time length in “Auto Power off (min.)” menu in “System Settings → Power”. If you want the projector to enter standby mode instead, disable auto power off and set the sleep time interval in “System Settings → Power → Sleep Timer (min.)”.*

USING THE PROJECTOR

Menu navigation and features

The projector has multilingual on-screen display (OSD) menus that allow you to make image adjustments and change a variety of settings.

1. To open the OSD menu, press the **Menu** key on the remote control or projector keypad.
2. To select a main menu or sub menu, use the **▲▼** buttons to highlight it. Then, press the **Enter** button to enter the sub menu.
3. Press the **Exit** button to return to the previous menu or exit the OSD menu if at top level.
4. Setting methods to adjust the function value or selection an option.
 - To adjust the slide bar values, highlight the function, and use the **◀▶** buttons to change value.
 - To check or uncheck a checkbox, highlight the function, and press **Enter**.
 - To input a number or symbol, highlight the number or symbol, and use the **▲▼** buttons to make a selection. You can also use the number keys on the remote control or keypad.
 - To select a function option, use the **▲▼◀▶** buttons to make the selection. If no **Enter** icon shows at the navigation bar, the highlighted option is automatically applied. If there is an **Enter** icon at the navigation bar, press **Enter** to confirm your selection.

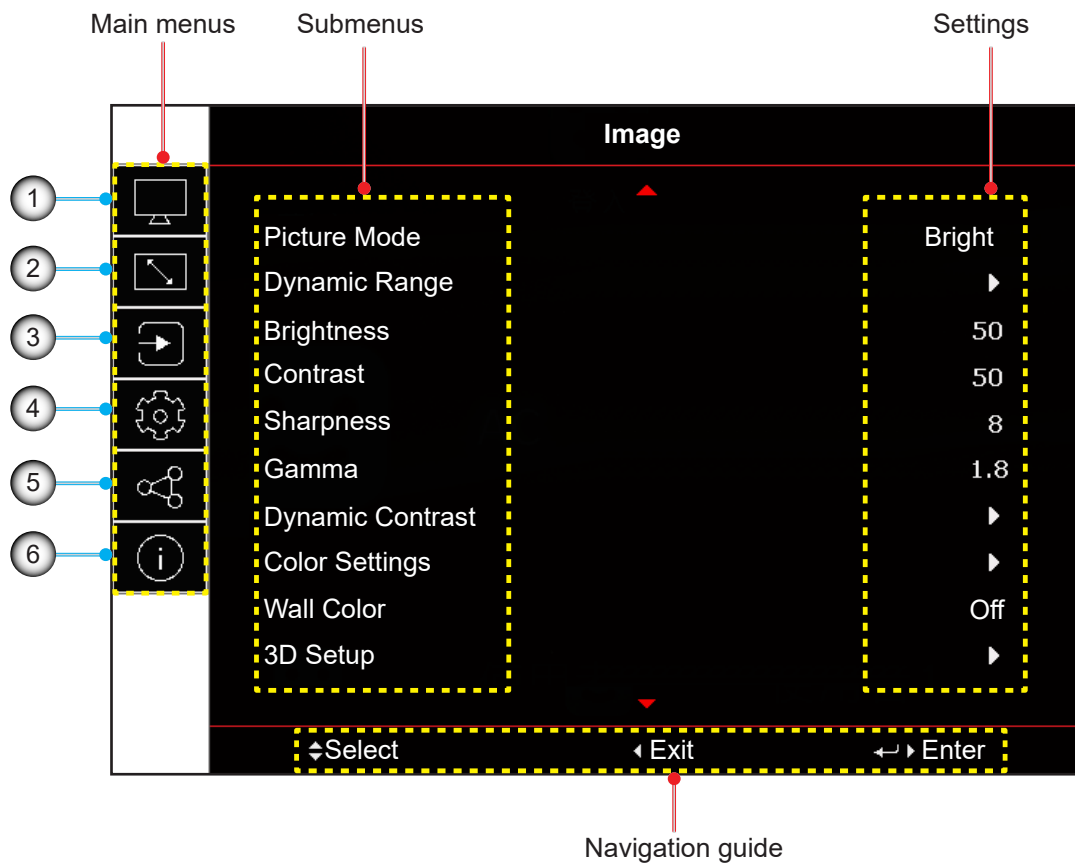

No	Item	No	Item
1.	Image menu	4.	Device setup menu
2.	Display menu	5.	Communication menu
3.	Input settings menu	6.	Information menu

USING THE PROJECTOR

OSD menu tree

Main Menu	Sub Menu 2	Sub Menu 3	Sub Menu 4	Sub Menu 5	Sub Menu 6	Values
Image	Picture Mode					Presentation
						Bright [default]
						Cinema
						HDR
						sRGB
						DICOM SIM.
						Blending
						3D
						2D High Speed
						User
	Dynamic Range	HDR				Off
						Auto [default]
		HDR Picture Mode				Bright
						Standard [default]
						Film
						Detail
	Brightness					0~100 [default: 50]
	Contrast					0~100 [default: 50]
	Sharpness					1~15 [default: 10]
	Gamma					Film
						Graphics
						Standard(2.2)
						Vivid
						3D
						Blackboard
						DICOM SIM.
						1.8
						2.0
						2.4
						2.6
	Dynamic Contrast	Dynamic Black				Off [default]
						On
		Speed				1~15 [default: 1]
		Strength				0~3 [default: 2]
		Level				50%~100% [default: 100%]
		Extreme Black				Off [default]
						On
		AV Mute Timer				0s~10s [default: 0s]
		Black Signal Level				0~5 [default: 0]

USING THE PROJECTOR

Main Menu	Sub Menu 2	Sub Menu 3	Sub Menu 4	Sub Menu 5	Sub Menu 6	Values		
Image	Color Settings	Color				0~100 [default: 60]		
		Tint				0~100 [default: 50]		
		Color Temperature				Warm		
						Standard [default]		
						Cool		
		Color Wheel Speed				2X		
						3X [default]		
		White Balance	Red Gain				0-100 [default: 50]	
				Green Gain			0-100 [default: 50]	
							0-100 [default: 50]	
				Blue Gain			0-100 [default: 50]	
							0-100 [default: 50]	
				Blue Offset			0-100 [default: 50]	
					0-100 [default: 50]			
		White Enhancement				0~10 [default: 10]		
		Color Space					Auto [default]	
							RGB (0-255)	
							RGB (16-235)	
							REC709	
							REC601	
		Color Matching	Auto Test Pattern				Off	
							On [default]	
			Red	Hue				0~254 [default: 127]
					Saturation			0~254 [default: 127]
								0~254 [default: 127]
			Green	Hue				0~254 [default: 127]
					Saturation			0~254 [default: 127]
								0~254 [default: 127]
			Blue	Hue				0~254 [default: 127]
					Saturation			0~254 [default: 127]
								0~254 [default: 127]
			Cyan	Hue				0~254 [default: 127]
					Saturation			0~254 [default: 127]
								0~254 [default: 127]
			Magenta	Hue				0~254 [default: 127]
					Saturation			0~254 [default: 127]
								0~254 [default: 127]
			Yellow	Hue				0~254 [default: 127]
					Saturation			0~254 [default: 127]
								0~254 [default: 127]
			White	Red				0~254 [default: 127]
					Green			0~254 [default: 127]
						0~254 [default: 127]		
Reset						Yes		
						Cancel [default]		

USING THE PROJECTOR

Main Menu	Sub Menu 2	Sub Menu 3	Sub Menu 4	Sub Menu 5	Sub Menu 6	Values	
Image	Wall Color					Off [default]	
						Blackboard	
						Light Yellow	
						Light Green	
						Light Blue	
						Pink	
						Gray	
	3D Setup	3D Mode					Off
							Active 3D [default]
		3D Format					Auto [default]
							Frame Packing
							Side by Side
							Top and Bottom
							Frame Sequential
		3D Tech					DLP-link
							3D Sync [default]
		3D-2D					3D [default]
							L
							R
		3D Sync Out					To Emitter [default]
							To Next Projector
		3D Invert					Off [default]
							On
		Frame Delay					1~200 [default: 1]
		Reset					Yes
							Cancel [default]
	Save to User					Yes	
					Cancel [default]		
Apply to User					User-Presentation		
					User-Bright [default]		
					User-Cinema		
					User-HDR		
					User-sRGB		
					User-DICOM SIM.		
					User-Blending		
					User-3D		
Reset					User-2D High Speed		
					Yes		
					Cancel [default]		

USING THE PROJECTOR

Main Menu	Sub Menu 2	Sub Menu 3	Sub Menu 4	Sub Menu 5	Sub Menu 6	Values		
Display	Aspect Ratio					Auto [default]		
						4:3		
						16:9		
						16:10		
						LBX		
						Native		
	Digital Zoom	Proportional					Off [default]	
							On	
		Horizontal					50%~400% [default: 100]	
		Vertical					50%~400% [default: 100]	
		Horizontal Shift					0~100 [default: 50]	
		Vertical Shift					0~100 [default: 50]	
		Reset					Yes	
	Image Shift	H. Position					0~100 [default: 50]	
							0~100 [default: 50]	
							Yes	
		Reset					Cancel [default]	
	Geometric Correction	Warp Control					Basic [default]	
							Advanced	
							AP	
		Basic Warp	Keystone	Horizontal				0~40 [default: 20]
				Vertical				0~40 [default: 20]
		Pincushion		Horizontal				0~100 [default: 50]
Vertical							0~100 [default: 50]	
4-Corner			Top Left					
			Top Right					
			Bottom Left					
			Bottom Right					
Advanced Warp		Grid Color					Green [default]	
							Magenta	
							Red	
							Cyan	
	Grid Background						Black [default]	
							Transparent	
	Warp Setting	Grid Points					2x2 [default]	
							3x3	
							5x5	
							9x9	
							17x17	
		Warp Inner						Off [default]
							On	
Blend Setting	Warp Sharpness					0~9 [default: 9]		
		Blend Width				[default: 0]		
							4 [default] / 6 / 8 / 10 / 12	
							Gamma	
						1.8 / 1.9 / 2.0 / 2.1 / 2.2 [default] / 2.3 / 2.4		

USING THE PROJECTOR

Main Menu	Sub Menu 2	Sub Menu 3	Sub Menu 4	Sub Menu 5	Sub Menu 6	Values	
Display	Geometric Correction	Advanced Warp	Black Level	Area		Bottom [default]	
						Top	
					Enable	Off [default]	
						On	
					Edit Area		
					Add Point		
					Remove Point		
					Brightness	Brightness	
						Red	0~255 [default: 20]
						Green	0~255 [default: 20]
					Blue	0~255 [default: 20]	
					Exit		
					Red	0~255 [default: 20]	
					Green	0~255 [default: 20]	
					Blue	0~255 [default: 20]	
				Reset	Bottom	Yes	
						Cancel [default]	
					Top	Yes	
						Cancel [default]	
					All	Yes	
						Cancel [default]	
					Memory	Save Memory	
						Memory 1 [default] ~Memory 5	
						Apply Memory	
						Memory 1 [default] ~Memory 5	
						Clear Memory	
						Yes	
		Cancel [default]					
	Reset	Yes					
		Cancel [default]					
	Edge Mask	0~10 [default: 0]					
	Freeze Screen	Unfreeze [default]					
		Freeze					
	Test Pattern	Off [default]					
		Green Grid					
		Magenta Grid					
		White Grid					
		White					
		Black					
		Red					
		Green					
		Blue					
		Yellow					
		Magenta					
		Cyan					
		ANSI Contrast 4x4					
		Color bar					
		Full screen					

USING THE PROJECTOR

Main Menu	Sub Menu 2	Sub Menu 3	Sub Menu 4	Sub Menu 5	Sub Menu 6	Values	
Display	PIP/PBP	Screen				Off [default]	
						PIP	
						PBP	
			Main Source				VGA
						HDMI1	
						HDMI2	
						HDBaseT	
			Sub Source				VGA
						HDMI1	
						HDMI2	
							HDBaseT
			Swap				Swap
			Size				Small [default]
							Medium
							Large
			Location				PBP, Main Left [default]
							PBP, Main Top
							PBP, Main Right
							PBP, Main Bottom
							PIP, Bottom Right [default]
					PIP, Bottom Left		
					PIP, Top Left		
					PIP, Top Right		
	Reset				Yes		
					Cancel [default]		
Input Settings	Auto Source					Off	
						On [default]	
	Quick Resync					Off	
						On [default]	
	Active Inputs					VGA [default]	
						HDMI1	
						HDMI2	
						HDBaseT	
	Latency Adjustment					Normal [default]	
						2D Ultra	
	VGA	Phase				0 ~ 100 [default: 50]	
		Resolution				[read only]	
	HDMI	Output				HDMI 1 [default]	
						HDMI 2	
		HDMI 1 EDID					1.4
							2.0 [default]
		HDMI 2 EDID					1.4
							2.0 [default]
Reset					Yes		
					Cancel [default]		

USING THE PROJECTOR

Main Menu	Sub Menu 2	Sub Menu 3	Sub Menu 4	Sub Menu 5	Sub Menu 6	Values	
Device Setup	Language					English [default]	
						Deutsch	
						Français	
						Italiano	
						Español	
						Português	
						Polski	
						Nederlands	
						Norsk	
						繁體中文	
						簡體中文	
						日本語	
						한국어	
						Русский	
				Magyar			
				ไทย			
Projection	Ceiling					Auto [default]	
						On	
						Off	
						Off [default]	
Projection	Rear					On	
						Off [default]	
Lens Settings	Focus					[Focus for adjust]	
						[Zoom for adjust]	
						[Pattern for adjust]	
		Lens Shift Memory	Save Memory				Memory 1~Memory 5
			Apply Memory				Memory 1~Memory 5
			Clear Memory				Yes
							Cancel [default]
		Lens Calibration					Yes
							Cancel [default]
		Lens Lock					Lock
					Unlock [default]		
Reset					Yes		
					Cancel [default]		
Schedule	Date and Time					Read Only	
		Schedule Mode				Off [default]	
						On	
	View Today				Monday / Tuesday / Wednesday / Thursday / Friday / Saturday / Sunday [Read only]		

USING THE PROJECTOR

Main Menu	Sub Menu 2	Sub Menu 3	Sub Menu 4	Sub Menu 5	Sub Menu 6	Values
Device Setup	Schedule	Monday / Tuesday / Wednesday / Thursday / Friday / Saturday / Sunday	Schedule Enable			Off [default]
						On
			Event 01-08	Time		00:00 ~ 23:59
				Function		Off [default] / Power Settings / Input Source / Light Source Mode / Shutter
			Event 09-16	Event		Off [Function = Off]
				(Function = Power Settings)		Power On [Function = Power Settings] / Eco / Active / Communication
			(Function = Input Source)		VGA [Function = Input Source] / HDMI1 / HDMI2 / HDBaseT	
			(Function = Light Source Mode)		Normal Mode [Function = Light Source Mode] / Eco Mode / Custom Brightness	
			(Function = Shutter)		Shutter On [Function = Shutter] / Shutter Off	
			Reset		Yes	
			Cancel [default]			
		Copy Events To		Monday / Tuesday / Wednesday / Thursday / Friday / Saturday / Sunday		
		Reset the Day		Yes		
				Cancel [default]		
		Reset Schedule		Yes		
				Cancel [default]		
	Date and Time	Clock Mode		Use NTP Server [default]		
				Manual		
		Date		2000 ~ 2037 (Year) [default: 2020]		
				01 ~ 12 (Month) [default: 1]		
				01 ~ 31 (Day) [default: 1]		
		Time		00 ~ 23 (Hour) [default: 0]		
				00 ~ 59 (Minute) [default: 0]		
Daylight Saving Time			Off [default]			
			On			
NTP Server			time.google.com [default]			
			asia.pool.ntp.org			
			europa.pool.ntp.org			
			north-america.pool.ntp.org			
Time Zone		[default: UTC+00:00]				
Update Interval		Hourly [default]				
		Daily				
Apply		Yes				
		Cancel [default]				

USING THE PROJECTOR

Main Menu	Sub Menu 2	Sub Menu 3	Sub Menu 4	Sub Menu 5	Sub Menu 6	Values	
Device Setup	Power Settings	Power Mode (Standby)				Eco	
						Active	
						Communication [default]	
			Signal Power On				Off [default]
							On
			Auto Power Off				0 ~ 180m [default: 0m]
			Sleep Timer				0 ~ 16h [default: 0h]
			12V Trigger				Off [default]
							On
			Reset				Yes
Light Source Settings	Light Source Mode	Light Source Mode				Cancel [default]	
						Normal [default]	
						Eco Mode	
			Custom Brightness	Brightness Level			30% ~ 100% [default: 100%]
				Constant Brightness			Off [default]
Shutter	Fade-In	Fade-Out	Startup			0.5 ~ 5s [default: 0.5s]	
							0.5 ~ 5s [default: 0.5s]
							Shutter Off [default]
							Shutter On
Audio	Mute	Volume				Off [default]	
						On	
						0 ~ 10 [default: 5]	
Security	Security	Security Timer	Month	Day	Hour	Off [default]	
						On	
						0 ~ 35 [default: 0]	
					0 ~ 29 [default: 0]		
					0 ~ 23 [default: 0]		
	Change Password						
On Screen Display	Menu Location	Menu Transparency	Menu Timer	Information Hide	Background	Top Left	
						Top Right	
						Center [default]	
						Bottom Left	
						Bottom Right	
						0 ~ 9 [default: 0]	
						Off	
						5s	
						10s	
						15s [default]	
30s							
60s							
Off [default]							
On							
Blue							
Black							
White							
Logo [default]							

USING THE PROJECTOR

Main Menu	Sub Menu 2	Sub Menu 3	Sub Menu 4	Sub Menu 5	Sub Menu 6	Values
Device Setup	Logo Setup	Change Logo				Default Logo [default]
						Neutral
						User Logo
						Captured Logo
		Logo Capture				Yes
						Cancel [default]
		Delete Logo	Captured Logo			Yes
					Cancel [default]	
			User Logo			Yes
						Cancel [default]
		High Altitude				Off [default]
						On
	User Data	Save all settings				Memory 1 [default] ~ Memory 5
		Load all settings				Memory 1 [default] ~ Memory 5
System Update	Auto				Off [default]	
					On	
	Auto Download				Off	
	Update				On [default]	
					Cancel [default]	
					Yes	
Reset	Reset OSD				Yes	
					Cancel [default]	
	Reset to default				Yes	
					Cancel [default]	
	Reset Selective	Image				Yes
						Cancel [default]
		Display				Yes
						Cancel [default]
		Input				Yes
						Cancel [default]
Communication				Yes		
				Cancel [default]		
	Setup				Yes	
					Cancel [default]	
Communication	Projector ID					0 ~ 99 [default: 0]
	Remote Setup	Remote Code				0 ~ 99 [default: 0]
		Quick Switch Code				Off [default]
						1 ~ 9
	IR Function	Front				Off
						On [default]
		Top				Off
						On [default]
		HDBaseT				Off [default]
						On

USING THE PROJECTOR

Main Menu	Sub Menu 2	Sub Menu 3	Sub Menu 4	Sub Menu 5	Sub Menu 6	Values	
Communication	Remote Setup	User 1				Freeze Screen [default]	
						Blank Screen	
						PIP/PBP	
						Aspect Ratio	
						Information Hide	
						Network setup	
						Projector ID	
						Color Matching	
						Reset Selective	
						Quick Switch Code	
				Audio Mute			
				Audio Volume			
		User 2				Freeze Screen	
					Blank Screen		
					PIP/PBP [default]		
					Aspect Ratio		
					Information Hide		
					Network setup		
					Projector ID		
					Color Matching		
				Reset Selective			
				Quick Switch Code			
			Audio Mute				
			Audio Volume				
Network Setup	LAN Interface					RJ-45 [default]	
						HDBaseT	
							[read only]
							[read only] Connected
							[read only] Disconnected
							Off [default]
							On
							[default: 192.168.0.100]
							[default: 255.255.255.0]
							[default: 192.168.0.51]
							[default: 0.0.0.0]
							Yes
							Cancel [default]
							Yes
Email Notification	Email						
						[read only]	
						[read only]	
						Off [default]	
						Email	
					Off [default]		
					Email		

USING THE PROJECTOR

Main Menu	Sub Menu 2	Sub Menu 3	Sub Menu 4	Sub Menu 5	Sub Menu 6	Values	
Communi- cation	Email Notification	Video Loss				Off [default]	
						Email	
		Laser				Off [default]	
						Email	
			Reset			Yes	
						Cancel [default]	
		Control	Crestron				Off
							On [default]
			IP Address				[default: 192.168.0.2]
			IP ID				2 ~ 255 [default: 5]
			Port				0 ~ 65535 [default: 41794]
			Crestron Setup Apply				Yes
							Cancel [default]
			PJ Link				Off
							On [default]
			Authentication				Off [default]
							On
			Password				[read only]
			Service				[default: 192.168.0.3]
			PJ Link Setup Apply				Yes
						Cancel [default]	
	Extron					Off	
					On [default]		
	AMX				Off		
					On [default]		
	Telnet				Off		
					On [default]		
	HTTP				Off		
					On [default]		
	Reset				Yes		
					Cancel [default]		
	Baud Rate	Serial Port In				1200	
							2400
							4800
							9600
							19200
							38400
							57600
					115200 [default]		
	Reset					Yes	
						Cancel [default]	

USING THE PROJECTOR

Main Menu	Sub Menu 2	Sub Menu 3	Sub Menu 4	Sub Menu 5	Sub Menu 6	Values
Information	Device	Regulatory				
		Serial Number				
		Projection Hours				
System Status	System Status	Standby Mode				
		Light Source Mode				
		Light Source Hours				
		Total Hours				
		Normal				
		Eco Mode				
		Custom Power				
		Ambient Temp				
		Temperature				
Communication	Communication	Projector ID				
		Remote Code				
		Network				
		LAN Interface				
		MAC Address				
		Network Status				
		DHCP				
		IP Address				
		Subnet Mask				
		Gateway				
		DNS				
		Control				
		Crestron				
		Extron				
		PJ Link				
		AMX				
Telnet						
HTTP						
Signal	Signal	Input Signal				
		Resolution				
		Signal Format				
		Pixel Clock				
		Horz Refresh				
		Vert Refresh				
		Color Space				
		Picture Mode				
		Second Signal				
		Resolution				
		Signal Format				
		Pixel Clock				
		Horz Refresh				
		Vert Refresh				
Color Space						

USING THE PROJECTOR

Main Menu	Sub Menu 2	Sub Menu 3	Sub Menu 4	Sub Menu 5	Sub Menu 6	Values
Information	Firmware Version	Main Version				
		I-SCALER Version				
		F-MCU Version				
		M-MCU Version				
		A-MCU Version				
		LAN Version				
		Formatter Version				
		HDBaseT Version				
		Camera Version				

USING THE PROJECTOR

Image menu

Learn how to configure image settings.

Submenus

- Picture Mode
- Dynamic Range
- Brightness
- Contrast
- Sharpness
- Gamma
- Dynamic Contrast
- Color Settings
- Wall Color
- 3D Setup

Picture Mode

There are many factory presets optimized for various types of images.

Presentation

This mode is suitable for showing in front of public in connection to the PC.

Bright

Maximum brightness from PC input.

Cinema

Provides the best colors for watching movies.

HDR

Decodes and displays High Dynamic Range (HDR) content for the deepest blacks, brightest whites, and vivid cinematic color using REC.2020 color gamut. This mode will be automatically enabled if HDR is set to Auto (and HDR Content is sent to projector – 4K UHD Blu-ray, 1080p/4K UHD HDR Games, 4K UHD Streaming Video). While HDR mode is active, other display modes (Cinema, Reference, etc.) cannot be selected as HDR delivers color that is highly accurate, exceeding the color performance of the other display modes.

sRGB

Standardized accurate color.

DICOM SIM.

This mode can project a monochrome medical image such as an X ray radiography, MRI, etc.

Blending

When using multiple projectors, this mode can eliminate the visible banding and create a single bright, high resolution image across the screen.

3D

To experience the 3D effect, you need to have 3D glasses, make sure your PC/portable device has a 120 Hz signal output quad buffered graphics card and have a 3D Player installed.

2D High Speed

Displays the status of 2D High Speed mode.

User

Memorize user's settings.

USING THE PROJECTOR

Note:

- When 3D mode is selected, the Presentation, Bright, Cinema, HDR, sRGB, DICOM SIM., Blending, and 2D High Speed mode will be unavailable.
- When 2D High Speed mode is selected, the Presentation, Bright, Cinema, HDR, sRGB, DICOM SIM., Blending, and 3D mode will be unavailable.
- When Blending mode is selected, the HDR, 3D, and 2D High Speed will be unavailable.

Dynamic Range

Configure the High Dynamic Range (HDR) setting and its effect when displaying video from 4K Blu-ray players and streaming devices.

Note: Only HDMI supports the Dynamic Range function.

HDR (High Dynamic Range)

- **Off:** Turn off HDR Processing. When set to Off, the projector will NOT decode HDR content.
- **Auto:** Auto detect HDR signal.

HDR Picture Mode

- **Bright:** Choose this mode for brighter more saturated colors.
- **Standard:** Choose this mode for natural looking colors with a balance of warm and cool tones.
- **Film:** Choose this mode for improved detail and image sharpness.
- **Detail:** The signal comes from OETF conversion to achieve the best color matchings.

Brightness

Adjust the brightness of the image.

Contrast

The contrast controls the degree of difference between the lightest and darkest parts of the picture.

Sharpness

Adjust the sharpness of the image.

Gamma

Set up gamma curve type. After the initial setup and fine tuning is completed, utilize the Gamma Adjustment steps to optimize your image output.

Film

For home theater.

Graphics

For PC / Photo source.

Standard (2.2)

For standardized setting.

Vivid

Best for playing games. In this mode, color saturation and brightness are well-balanced.

3D

Best for playing 3D videos.

USING THE PROJECTOR

Blackboard

Best for projecting on to a blackboard.

DICOM SIM.

Best for projecting monochrome medical images, such as X-ray diagram.

1.8 / 2.0 / 2.4 / 2.6

For specific PC / Photo source.

Note: *When Blending mode is selected, only gamma Standard2.2 is supported.*

Dynamic Contrast

Set up the Dynamic Contrast to maximize the contrast for dark content.

- **Dynamic Black:** Enable this function to automatically adjust the contrast ratio for video sources. It improves the black level in dark scenes by reducing the light output.
- **Speed:** Adjust the speed of the light source correction. The value ranges from 1 to 15. A lower value makes the correction slower and less aggressive while a higher value results in the faster correction.
- **Strength:** Set the strength of the dynamic contrast adjustment. The value ranges from 0 to 3, the higher the value the stronger the correction.
- **Level:** Adjust the light source when the brightness level of the current content gets lower than the set value. The value ranges from 50% to 100%. The higher the value, the larger the range to adjust the light source.
- **Extreme Black:** Enable this function to automatically increase the contrast ratio by turning off the laser light when black image is detected.
- **AV Mute Timer:** Set a timer for the laser light to turn off after detecting black content. The set value ranges from 0s to 10s.
- **Black Signal Level:** Set a black level value as the threshold for the Real Black function. The value can be adjusted from 0% to 5%, with 0 being the darkest black and 5 being the brightest.

Note:

- *When Dynamic Black is turned on, the Extreme Black will be unavailable.*
- *When Dynamic Black is turned off, the Speed, Strength, and Level will be unavailable.*
- *When Extreme Black is turned on, the Dynamic Black, Speed, Strength, and Level will be unavailable.*

Color Settings

Configure the color settings of the projected image to improve the color performance.

Color

Adjust the saturation of the selected color. The value indicates the color shifts from or towards the white in the center of the chromaticity diagram.

Tint

Adjust the color balance of red and green in video images.

Color Temperature

Adjust the color temperature of the projected image. The available options are Warm, Standard, or Cool.

Color Wheel Speed

Set the projector color wheel speed to 2X or 3X.

White Balance

Adjust the white balance of the projected image via gain and offset. Gain and offset are individual controls for each RGB channels used to set greyscale. The Gains calibrate the color of the dark parts and Bias calibrate the white parts.

USING THE PROJECTOR

- **Red / Green / Blue Gain:** Adjust the color of the image's bright areas.
- **Red / Green / Blue Offset:** Adjust the color of the image's dark areas.

White Enhancement

Adjust the image color brightness while providing more vibrant colors, in increments from 0 to 10.

Color Space

Select a color space that has been specifically tuned for the input signal. The available options are Auto (default), RGB (0~255), RGB (16~235), REC709, and REC601.

Color Matching

Change the color of a projected image by adjusting each color component in the image. The adjustable color includes Red, Green, Blue, Cyan, Yellow, and Magenta (R / G / B / C / Y / M).

- **Auto Test Pattern:** Enable the function to view a specific color pattern while adjusting.
- **R / G / B / C / Y / M:** Select a color for further adjustment.
 - **Hue:** Adjust the hue of the selected color. The value reflects the number of degrees of rotation around the chromaticity diagram from the original color. Increasing value indicates counterclockwise rotation, and decreasing value, clockwise rotation.
 - **Saturation:** Adjust the saturation of the selected color. The value indicates the color shifts from or towards the white in the center of the chromaticity diagram.
 - **Luminance:** Adjust the luminance of the selected color. Increase the value to brighten the image (add white to a color) or decrease the value to darken the image (add black to a color).
- **Reset:** Reset the function settings to factory default values.

Note: *When 3D, 2D High Speed, or Blending mode is selected, the Color Temperature and White Enhancement will be unavailable.*

Wall Color

Set the wall color of the projector to achieve best color performance for a specific wall. The available options are Off, Blackboard, Light Yellow, Light Green, Light Blue, Pink, and Gray.

3D Setup

3D video file combines two slightly different images (frames) of the same scene representing the different views that the left and right eyes see. When these frames are displayed fast enough and viewed with 3D glasses synchronized with the left and right frames, the viewer's brain then assemble the separate images into a single 3D image. 3D Menu provides options to set up the 3D functions to correctly display 3D videos.

3D Mode

Enable or disable the 3D function.

3D Format

Select a proper 3D format for the 3D input signal. The available options are Auto, Frame Packing, Side by Side, Top and Bottom, and Frame Sequential.

3D Tech

Select a proper 3D technology according to how the 3D sync signal is processed.

- **DLP-Link:** Select DLP-Link when the 3D sync signal is generated by the DLP Link technology built into the projector. DLP Link works only with the glasses that are compatible with DLP 3D technology and the 3D function is enabled.
- **3D Sync:** Select 3D Sync when the 3D sync out signal is sent to an emitter or another projector through the 3D sync out port.

USING THE PROJECTOR

3D-2D

Transform the 3D content to 2D images.

- **3D:** Play the 3D content normally.
- **L:** Play the left images of the 3D content.
- **R:** Play the right image of the 3D content.

3D Sync Out

Set up the transmission of the 3D sync output signal.

- **To Emitter:** Send the 3D sync signal to the emitter connected to the 3D sync out port.
- **To Next Projector:** Send the 3D sync signal to next projector when using multiple projectors.

3D Invert

When the 3D video does not appear correctly, use this function to invert the 3D left and right frames.

Frame Delay

Set a frame delay value for the projector to correct the time difference between the 3D signal being given and the result being executed.

Reset

Reset the function settings to factory default values.

Note: *When 2D High Speed or Blending mode is selected, the 3D Tech, 3D-2D, 3D Sync Out, 3D Invert, Frame Delay will be unavailable.*

Save to User

Save the image settings to the User mode.

Apply to User

Apply the image settings to User-Presentation, User-Bright, User-Cinema, User-HDR, User-sRGB, User-DICOM SIM., User-Blending, User-3D, or User-2D High Speed.

Reset

Reset all the image settings to factory default values.

USING THE PROJECTOR

Display menu

Learn how to configure the settings to properly project images according to your installation circumstances.

Submenus

- Aspect Ratio
- Digital Zoom
- Image Shift
- Geometric Correction
- Edge Mask
- Freeze Screen
- Test Pattern
- PIP/PBP

Aspect Ratio

Set the aspect ratio of the projected image. The available options are Auto (default), 4:3, 16:9, 16:10, LBX, or Native. Select Auto to display the detected image size.

- **Auto:** Automatically selects the appropriate display format.
- **4:3:** This format is for 4:3 input sources.
- **16:9:** This format is for 16:9 input sources, like HDTV and DVD enhanced for Wide screen TV.
- **16:10:** This format is for 16:10 input sources, like widescreen laptops.
- **LBX:** This format is for non-16x9, letterbox source and if you use external 16x9 lens to display 2.35:1 aspect ratio in full resolution.
- **Native:** This format displays the original image without any scaling.

Note:

- *Detailed information about LBX mode*
 - *Some Letter-Box Format DVDs are not enhanced for 16x9 TVs. In this situation, the image will not look right when displaying image in 16:9 mode. In this situation, please try to use the 4:3 mode to view the DVD. If the content is not 4:3, there will be black bars around the image in 16:9 display. For this type of content, you can use LBX mode to fill the image on the 16:9 display.*
 - *If you use an external anamorphic lens, this LBX mode also allows you to watch a 2.35:1 content (include Anamorphic DVD and HDTV film source) that supports anamorphic wide is enhanced for 16x9 Display in a wide 2.35:1 image. In this case, there are no black bars. Light source power and vertical resolution are fully utilized.*
- *When 3D or 2D High Speed mode is selected, the Aspect Ratio will be unavailable.*

WUXGA Scaling Table

	480i/p	576i/p	1080i/p	720p	PC
Auto	- Fix Aspect ratio of input source signal and scale it up to one of the height or width meets the DMD resolution. - If source is 4:3, auto resize to 1600 x 1200. - If source is 16:9 auto resize to 1920 x 1080. - If source is 16:10 auto resize to 1920 x 1200.				
4x3	Scale to 1600 x 1200.				
16x9	Scale to 1920 x 1080.				
16x10	Scale to 1920 x 1200.				
LBX	Scale to 1920x1440, then get the central 1920x1200 image to display.				
Native	Mapping centered.				

USING THE PROJECTOR

Digital Zoom

Digital adjust the size of the projected image.

Proportional

Enable the function to have the image's height and width changed at the same ratio.

Horizontal

Use the ◀ and ▶ buttons to change the width of the projected image.

Vertical

Use the ▲ and ▼ buttons to change the height of the projected image.

Horizontal Shift

Use the ◀ and ▶ buttons to adjust the horizontal shift the image.

Vertical Shift

Use the ▲ and ▼ buttons to adjust the vertical shift the image.

Reset

Reset digital zoom settings to factory default values.

Note: When 3D or 2D High Speed mode is selected, the Digital Zoom will be unavailable.

Image Shift

Adjust the projected image position.

H. Position

Use the ◀ and ▶ buttons to adjust the projected image position horizontally.

V. Position

Use the ▲ and ▼ buttons to adjust the projected image position vertically.

Reset

Reset image shift settings to factory default values.

Note: When 3D or 2D High Speed mode is selected, the Image Shift will be unavailable.

Geometric Correction

Configure the geometric settings to reshape the image for different projection surfaces.

Warp Control

Configure the geometric settings to reshape the image for different projection surfaces.

- **Basic:** Configure keystone, pincushion, 4-corner settings.
- **Advanced:** Configure grid color, grid background, warp setting, blend setting, and black level.
- **AP:** Use the warp and blend software tools to control the projector. When the software warp and blend control is enabled, the projector's built in geometry functions are disabled.

USING THE PROJECTOR

Basic Warp

Configure basic warp settings.

Note: When Advanced or AP of Warp Control is selected, the Keystone, Pincushion, 4-Corner will be unavailable.

- **Keystone:** Keystone function is used to adjust the images in asymmetric rectangle shape.
 - **Horizontal:** Adjust the left and right side of the projected image to make it an even rectangle. It is used for the images with unequal left and right sides.

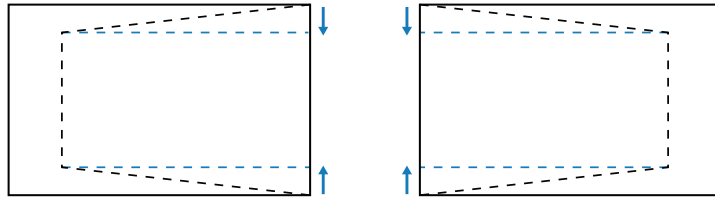

- **Vertical:** Adjust the top and bottom side of the projected image to make it an even rectangle. It is used for the images with unequal top and bottom sides.

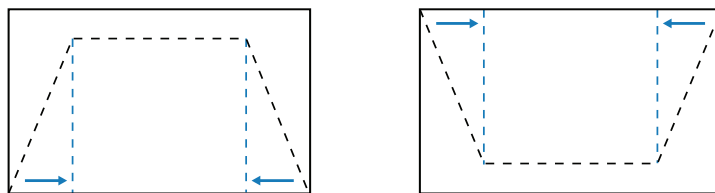

- **Pincushion:** Pincushion function is used to adjust the image with barrel or pincushion distortion.
 - **Horizontal:** Correct the projected image with horizontal barrel or pincushion distortion.

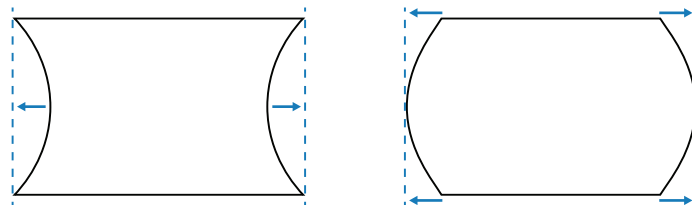

- **Vertical:** Correct the projected image with vertical barrel or pincushion distortion.

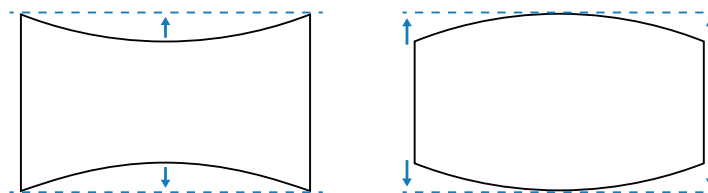

- **4-Corner:** Reshape the image by moving the 4 corners of the image to have it fit a specific projection surface.

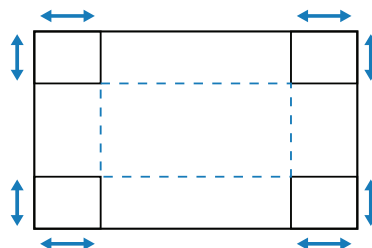

USING THE PROJECTOR

Advanced Warp

Configure advanced warp settings.

Note: When Basic or AP of Warp Control is selected, the Advanced Warp will be unavailable.

- **Grid Color:** Select a grid color for warp and blend pattern between Green, Magenta, Red, and Cyan.
- **Grid Background:** Select the grid background between Black and Transparent.
- **Warp Setting:** Configure warp settings.
 - **Grid Point:** Set the grid points of warp pattern. Options include: 2x2 (default), 3x3, 5x5, 9x9, and 17x17.
 - **Warp Inner:** Turn on to adjust the inner grid.
 - **Warp Sharpness:** When the grid lines are warped from straight into curve, the grid lines will be distorted and become jagged. To avoid the line jaggging, adjust the warp sharpness to blur or sharpen the edge of the images.
- **Blend Setting:** Configure the blend settings directly on the projector to merge two or more adjacent images into one larger and seamless image.
 - **Blend Width:** Set the blend pattern width.
 - **Overlap Grid Number:** Set the blend overlap grid number.
 - **Gamma:** Select the gamma value of the blend area to adjust the curvature of the blending effect.

Note: For installation flexibility we have not applied a FW limitation to the blending menu of this device. Distortion may occur if you attempt to warp to an extreme level. For more complex installs, at a cost, please contact your dealer for external devices for warping.

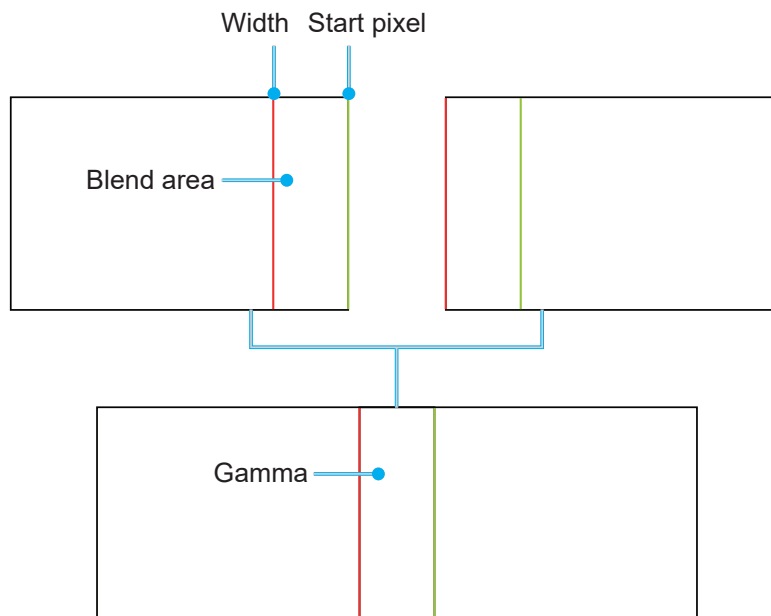

USING THE PROJECTOR

- **Black Level:** When two images overlap, the overlapping area can appear differently from the areas that do not overlap. You can use the projector's Black Level setting to make the difference less noticeable.
 - **Area:** Mark the area that needs adjusting.
 - **Enable:** Enable or disable the black level adjustment in the selected area.
 - **Edit Area:** Modify the black level of the selected area.
 - **Add Point:** Add up to 32 area control points for black level adjustment.
 - **Remove Point:** Remove at least 4 control points from the selected area.

Note: After adding or removing a control point, press **Enter** to move to the next point counterclockwise.

 - **Brightness:** Adjust the brightness of the selected area.
 - **Red/Green/Blue:** Adjust each color individually of the selected area.
 - **Reset:** Reset the black level to factory default values either on the Bottom or on the Top area or on both areas.

Memory

The projector allows the user to save up to five geometry memories, including the ones set directly on the projector and the ones configured via external software tools. The available options are Save Memory, Apply Memory, and Clear Memory.

Reset

Reset geometric settings to factory default values.

Edge Mask

The edge blending function allows you to hide one or multiple edges of the projected image. You can use this function to remove the video encoding noise on the edges of the video images.

Note: When 3D, 2D High Speed, or PIP/PBP is turned on, the Edge Mask will be unavailable.

Freeze Screen

Select to pause the display screen despite any change in the source device.

Test Pattern

Select a test pattern. The available options are Off, Green Grid, Magenta Grid, White Grid, White, Black, Red, Green, Blue, Yellow, Magenta, Cyan, ANSI Contrast 4x4, Color bar, and Full screen.

PIP/PBP

PIP/PBP (picture in picture/picture by picture) allows simultaneously displaying two images from two input sources.

Note: The PIP/PBP function does not support 3D, 2D High Speed mode, Aspect Ratio, Digital Zoom, and Image Shift.

Screen

Select the appropriate PIP/PBP mode or disable the function.

- **Off:** Disable PIP/PBP mode.
- **PIP:** Display one input source on the main screen and the other input source in an inset window.
- **PBP:** Display two images of the same size on the screen.

Main Source

Select an input source for the main image. The available input sources are VGA, HDMI1, HDMI2, and HDBaseT.

Sub Source

Select an input source for the main image. The available input sources are VGA, HDMI1, HDMI2, and HDBaseT.

USING THE PROJECTOR

Swap

Swap the main source and sub source.













Size

Change the display size of the sub source in PIP mode. The available options are Large, Medium, and Small.













Location

Adjust the location of the sub image. In the layout chart below, the “P” indicates the main image:

- **PBP Layout**

PBP Layout	PBP Size		
	Small	Medium	Large
PBP, Main Left			
PBP, Main Right			
PBP, Main Top			
PBP, Main Bottom			

- **PIP Layout**

PIP Layout	PIP Size		
	Small	Medium	Large
PIP, Bottom Right			
PIP, Bottom Left			
PIP, Top Left			
PIP, Top Right			

USING THE PROJECTOR

Note: PIP/PBP compatibility table as described below.

PIP/PBP		Main Source					
		VGA	HDMI 2.0	HDMI 1.0		HDBaseT	
			v1.4	v1.4	v2.0		
Sub Source	VGA	—	V	V	V	V	
	HDMI 2.0	v1.4	V	—	V	V	
	HDMI 1.0	v1.4	V	V	—	—	V
		v2.0	V	V	—	—	V
	HDBaseT		V	V	V	V	—

Note:

- a) Flashing lines may occur if the bandwidth of both inputs are too high, please try to reduce the resolution.
- b) Frame tearing may occur due to a difference in frame rate between the Main and the Sub picture, please try to match the frame rate for each input.

Reset

Reset all the display settings to factory default values.

USING THE PROJECTOR

Input Settings menu

Learn how to configure the projector input settings.

Submenus

- Auto Source
- Quick Resync
- Active Inputs
- Latency Adjustment
- VGA
- HDMI

Auto Source

When Auto Source is enabled, the projector automatically detects and selects the input signal. Once an input source is selected, press the Input button on the remote control or keypad to switch to other available sources. When the function is disabled, pressing Input will bring up the Active Inputs submenu.

Quick Resync

Set the quick resync feature.

Active Inputs

Select an input signal from the source list. The available input sources are VGA, HDMI1, HDMI2, and HDBaseT.

Latency Adjustment

Enable this feature to reduce response time.

VGA

Setup the VGA source by selecting the proper Phase and Resolution.

HDMI

Set the projector's HDMI ports.

Output

Set the HDMI 1 or HDMI 2 port to output the signal.

HDMI 1 EDID/HDMI 2 EDID

When receiving a HDMI signal, set the projector's EDID compatibility to display the signal correctly. Select 1.4 for the input devices with HDMI 1.4, or 2.0 for HDMI 2.0 devices.

Note: *For a better 3D experience, it is recommended to choose HDMI 1.4.*

Reset

Reset all the input settings to factory default values.

USING THE PROJECTOR

Device Setup menu

Learn how to configure the system settings for the projector.

Submenus

- Language
- Projection
- Lens Settings
- Schedule
- Date and Time
- Power Settings
- Light Source Settings
- Shutter
- Audio
- Security
- On Screen Display
- Logo Setup
- High Altitude
- User Data
- System Update

Language

Select a language for the OSD menu. The available languages are English, German, French, Italian, Spanish, Portuguese, Polish, Dutch, Norwegian, Traditional Chinese, Simplified Chinese, Japanese, Korean, Russian, Hungarian, and Thai.

Projection

Change the image direction by selecting a proper projection mode.

Ceiling

Enable the function for ceiling mount installation.

Rear

Check the function for rear projection.

Lens Settings

Configure the lens settings to adjust the image quality and position.

Focus

Use the ▲ and ▼ buttons to adjust the focus of the projected image.

Zoom

Use the ⊕ and ⊖ buttons to adjust the size of the projected image.

USING THE PROJECTOR

Lens Shift

Use the ▲ ▼ ◀ ▶ buttons to adjust the lens position to shift the projected area.

Note: BX-CTA17 floating ring

- For better optical performance, manually adjust the floating ring before adjusting Zoom & Focus.
- Floating ring's label scale shows the projection distance.
- The projection distance is from the projector lens to the screen. For example, if the distance between the screen and the projector lens is 1.4 m, adjust the floating ring scale to "1.40" for better performance.

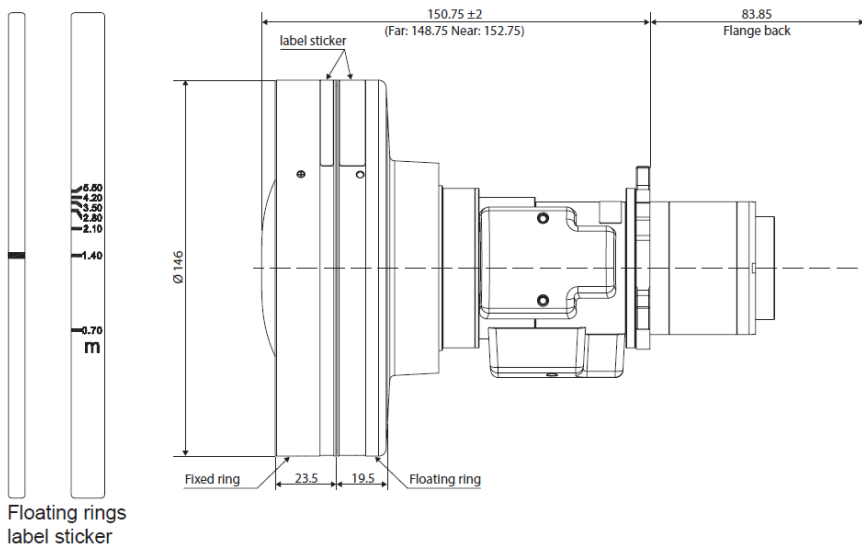

Lens Shift Memory

This projector can save up to five lens settings, which records the lens position, zoom and focus.

- **Save Memory:** Select a record from 1 to 5 to save the current lens settings.
- **Apply Memory:** Select a record from 1 to 5 to apply the lens settings.
- **Clear Memory:** Clear the saved lens records.

Note:

- Process the lens calibration before setup lens shift memory.
- Performing a lens calibration will clear the saved lens records.
- When the lens calibration is not completed, the lens shift memory will be unavailable.

Lens Calibration

Calibrate the lens position to return it to the center.

Lens Lock

Lock the lens to prevent the lens motors from moving, which disables all lens functions.

Note: When Lens Lock is turned on, the Focus, Zoom, Lens Shift, Lens Shift Memory, and Lens Calibration will be unavailable.

Reset

Reset the lens settings to factory default values.

Schedule

Schedule the projector functions to operate automatically at the set time.

Date and Time

Display the date and time for the projector.

USING THE PROJECTOR

Schedule Mode

Enable or disable the schedule function. If the projector is controlled via external devices or software, the Schedule Mode displays AP Mode, and the projector's schedule functions are grayed out.

View Today

View the event list scheduled for today.

Monday to Sunday

Set up the schedule for days of a week. On the Schedule menu page, select a day and configure the schedule settings.

- **Schedule Enable:** Enable or disable the schedule function for the selected day.
- **Event 01-08:** Select an event record number, and set up the schedule details.
 - **Time:** Set the time for the event.
 - **Event:** Select a function for the event, which operates automatically at the set time. The available functions are Power Settings, Input Source, Light Source Mode, and Shutter.
 - **Reset:** Reset the event settings.
- **More Events / Previous Events (Event 01-16):** Display more event records, and select one to set up the schedule details.
- **Copy Events To:** Copy the events setup for the day to another day.
- **Reset the Day:** Reset the schedule settings for the day.

Reset Schedule

Reset all of the schedule settings.

Date and Time

Set the date and time of the projector.

Clock Mode

Set the clock mode to NTP Server or Manual.

Note: *To use NTP Server, make sure the projector is connected to the Internet.*

Date

Set a date for the projector. The date format is in Year/Month/Date.

Time

Set the time for the projector.

Daylight Saving Time

Enable or disable the daylight savings function.

NTP Server

Select a NTP Server for the network clock mode.

Time Zone

Set a time zone for the network clock mode.

Update Interval

Set the date and time update interval.

Apply

Apply date and time modifications.

Note:

- *When Use NTP Server of Clock Mode is selected, the Date and Time will be unavailable.*
- *When Manual of Clock Mode is selected, the Daylight Saving Time, NTP Server, Time Zone, and Update Interval will be unavailable.*

USING THE PROJECTOR

Power Settings

Configure the projector's power settings.

Power Mode (Standby)

Setup the projector's standby mode.

- **Eco:** Minimum power consumption (0.5 Watt) which does not allow network control.
- **Active:** Low power consumption (< 2 Watt) which allows the LAN module to enter sleep mode and supports to be woken by Wake on LAN (WoL). When the LAN module is woken by WoL, the projector is ready to receive commands over the network.
- **Communication:** More power consumption that allows controlling the projector over the network.

Signal Power On

Turn on this function to have the projector automatically turning on when connected to HDMI input sources. It only applies to the standby projector set to Communication mode.

Auto Power Off

Set an interval timer for the projector to automatically turn off if no signal is detected within the specified time period. Press the ◀ and ▶ buttons to add or reduce time, 1 minutes for each press.

Sleep Timer

Set an interval timer for the projector to automatically turn off after operating for the specified amount of time.

12V Trigger

Use this function to enable or disable the trigger.

Note: 3.5mm TS type mini jack that outputs 12V 200mA (max.) for relay system control.

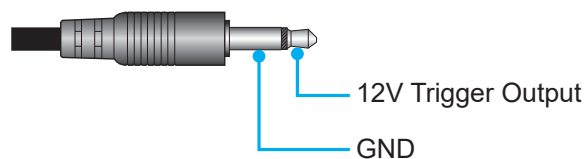

Reset

Reset the power settings to factory default values.

Light Source Settings

Set up the light source to control the projector brightness.

Light Source Mode

Select a light source mode depending on the installation requirements. The available options are Normal, Eco Mode, and Custom Power.

Custom Brightness

When the Light Source Mode is set to Custom Mode, set up the custom brightness level. Set up the Constant Brightness to maintain the image brightness at a specified level. A special algorithm is designed to compensate for the natural decay of brightness so that the image can be maintained at a fixed brightness level.

- **Brightness Level:** Adjust the brightness level from 30% to 100%.
- **Constant Brightness:** Enable to maintain the image brightness at the set brightness level. A special algorithm is designed to compensate for the natural decay of brightness so that the image can be maintained at a fixed brightness level.

Note: When Dynamic Black or Extreme Black is turned on, only Normal of Light Source Mode is supported.

Shutter

Set up the shutter behavior.

Fade-In

USING THE PROJECTOR

This function allows the fading-in effect when turning off the shutter. The length of the fading effect can be adjusted from 0.5s to 5s.

Fade-Out

This function allows the fading-out effect when turning on the shutter. The length of the fading effect can be adjusted from 0.5s to 5s.

Startup

Select the shutter behavior when turning on the projector.

- **Shutter Off:** Projector projects images normally after being powered on.
- **Shutter On:** Projector automatically turns on shutter after being powered on.

Audio

Set up the projector audio.

Mute

Turn off or turn on the projector sound.

Volume

Adjust the projector audio volume level.

Security

Set up security verification to protect the projector.

Security

Select On to protect the projector with a password. If the user enters incorrect password three times, a message will pop up warning that the projector shuts down in 10 seconds.

Security Timer

Specify the length of time the projector can be used without the password. Once the timer counts to 0, the user must enter a password to use the projector. The timer restarts every time the projector is turned on.

Change Password

Change the projector password.

Note: *In the last minute before reaching a specified timer, including Auto Power Off, Sleep Timer, and Security Timer, an on-screen message will pop up warning that the projector shuts down in 60 seconds. Press any button on the remote control or projector keypad to reset the timer and the projector remains on.*

On Screen Display

Set up the on screen display menus.

Menu Location

Select the menu location from Top Left, Top Right, Center, Bottom Left, and Bottom Right.

Menu Transparency

Set the menu transparency level.

Menu Timer

Set the length of time the menu displays on the screen.

Information Hide

Enable or disable the corner information messages, such as input source, IP address, and so on.

Background

Set a background color to display when no input signal is detected. The available options are Blue, Black, White, and Logo.

Logo Setup

Set up the logo for the startup screen.

USING THE PROJECTOR

Change Logo

Change the logo for the startup screen. Apart from the Default logo, user can select from Default, Neutral, User Logo, and Captured Logo.

- **Default:** The projector default logo.
- **Neutral:** The logo is not displayed on the startup screen.
- **User Logo:** The user logo uploaded from the web control panel.
- **Captured Logo:** The logo saved via the Logo Capture function.

Note: *The supported logo format is PNG and size is 1920 x 1200 pixels.*

Logo Capture

Capture part of the projected image and save it as a customized logo.

Delete Logo

Delete the saved customized logo, including the Captured Logo and Use Logo.

High Altitude

Select On to increase the fan speed. To ensure the image quality and prevent damage to the projector, enable High Altitude mode in high temperature, high humidity, or high altitude environment.

User Data

User can save the projector settings as user data and reload the settings later.

- **Save all settings:** Save all of the projector settings as user data. User can save up to 5 records.
- **Load all settings:** Load the previously saved user data.

System Update

Update the system automatically or manually.

- **Auto:** System checks for new updates automatically every time it is connected to the Internet.
- **Auto Download:** When both "Auto" and "Auto Download" are On, new updates will be downloaded automatically.
- **Update:** Manually update the system firmware.

Reset

Reset the settings to factory default values.

- **Reset OSD:** Reset OSD settings to default values.
- **Reset to Default:** Reset all projector settings to default values.
- **Reset Selective:** Reset the settings of one of the main menus. User can choose from Image, Display, Input, Communication, and Setup.

USING THE PROJECTOR

Communication menu

Communication menu is used to configure the settings that allow the projector to communicate with other projectors or control devices.

Submenus

- Projector ID
- Remote Setup
- Network Setup
- Email Notification
- Control
- Baud Rate

Projector ID

Assign an ID code for the projector from 00 to 99. Use this code as the projector ID when controlling the projector by RS232, Telnet or other control methods.

Remote Setup

Configure the settings of the Infra-Red (IR) remote control.

Remote Code

Set the remote custom code by pressing the remote ID button for 3 seconds and you will notice the remote indicator (above the Off button) starts blinking. Then, input a number between 00-99 using the keyboard numbered keys. After inserting the number, the remote indicator blinks twice quickly indicating that the remote code has changed.

Quick Switch Code

The IR receiving function of the projector can be temporarily deactivated by hot key(0~9) to avoid the IR interference between projectors. The remote ID needs to be set to All.

Note: When hotkey is on, the default function (Direct Source, Zoom/Focus, 3D) are inactive temporarily.

IR Function

Set the remote receiver for the projector to control the communication between the projector and the IR remote.

- **Front:** Enable or disable the front remote receiver.
- **Top:** Enable or disable the top remote receiver.
- **HDBaseT:** Select On to set the HDBaseT terminal as the remote receiver.

User 1 / User 2

Assign a function to the User 1 and User 2 buttons on the remote control. It allows you to use the function easily without going through the OSD menus. The available functions are Freeze Screen [User 1 default], Blank Screen, PIP/PBP [User 2 default], Aspect Ratio, Information Hide, Network setup, Projector ID, Color Matching, Reset Selective, Quick Switch Code, Audio Mute, and Audio Volume.

Network Setup

Configure the projector's network settings.

LAN Interface

To avoid clash, specify the LAN interface to RJ-45 or HDBaseT.

MAC Address

Display the MAC address. (Read only)

Network Status

Display the network connection status. (Read only)

USING THE PROJECTOR

DHCP

Turn on DHCP to automatically acquire IP address, subnet mask, gateway, and DNS.

IP Address

Assign the projector's IP address.

Subnet Mask

Assign the projector's subnet mask.

Gateway

Assign the projector's gateway.

DNS

Assign the projector's DNS.

Apply

Apply the wired network settings.

Network Reset

Reset the network settings to default factory values.

Note: *When DHCP is turned on, the IP Address, Subnet Mask, Gateway, and DNS will be unavailable.*

Email Notification

Set up the email notification for the projector.

Fan Error / Power On/Off / Video Loss / Laser

When a Fan Error, Power On/Off, Video Loss, or Laser occurs on the projector, an email notification will be sent to the user

Control

This projector can be controlled remotely by a computer or other external devices through wired network connection. It allows the user to control one or more projectors from a remote control center, such as powering the projector on or off, and adjusting the image brightness or contrast.

Use the Control submenu to select a control device for the projector.

Crestron

Control the projector with Crestron controller and related software (Port: 41794).

For more information, please visit <http://www.crestron.com>.

- **Crestron Setup:** Setup the Crestron IP Address, IPID, and Port. Then select Crestron Setup Apply to save the modifications.

PJ Link

Control the projector with PJLink v1.0 commands (Port: 4352).

For more information, please visit <http://pjlink.jbmia.or.jp/english>.

- **PJ Link Service:** Setup the address for the PJ Link Authentication, Password, Service, and select PJ Link Setup Apply to save the modifications.

Extron

Control the projector with Extron devices (Port: 2023).

For more information, please visit <http://www.extron.com>.

AMX

Control the projector with AMX devices. (Port: 9131)

For more information, please visit <http://www.amx.com>.

Telnet

Control the projector using RS232 commands through Telnet connection. (Port: 23)

For more information, refer to "Using RS232 command by Telnet" on page 66.

USING THE PROJECTOR

HTTP

Control the projector with web browser. (Port: 80)

For more information, refer to “Using the web control panel” on page 64.

Reset

Reset the control functions to default factory values.

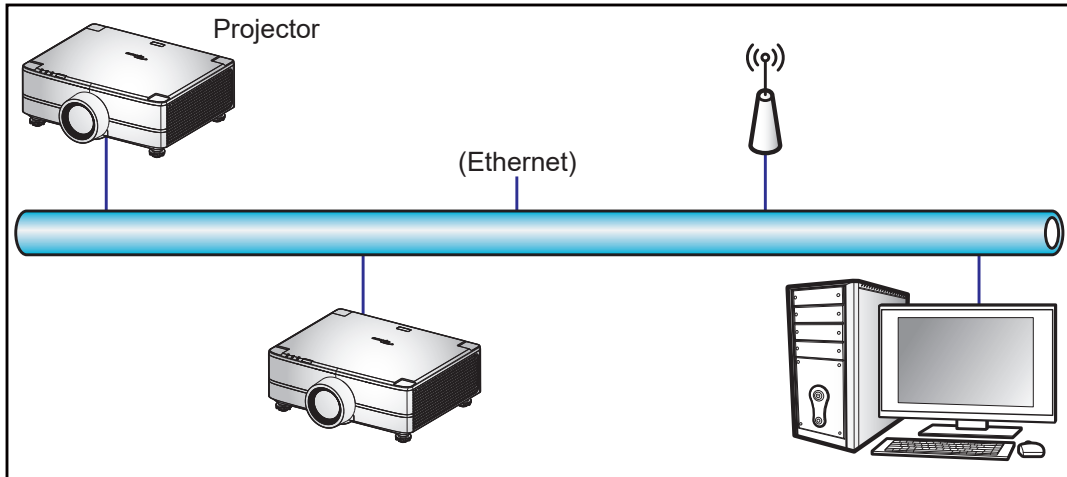

Note:

- *Crestron is a registered trademark of Crestron Electronics, Inc. of the United States.*
- *Extron is a registered trademark of Extron Electronics, Inc. of the United States.*
- *AMX is a registered trademark of AMX LLC of the United States.*
- *PJLink applied for trademark and logo registration in Japan, the United States of America, and other countries by JBMIA.*
- *For more information about the various types of external devices which can be connected to the LAN / RJ45 port and remotely control the projector, as well as the supported commands for these external devices, please contact the Support-Service directly.*
- *Support OMSC and OMSL. For more information, please contact the Support-Service directly.*

Baud Rate

Set the baud rate for Serial Port In and Serial Port Out. The available options are 1200, 2400, 4800, 9600, 19200, 38400, 57600, and 115200 (default).

Reset

Reset all network settings to default factory values.

USING THE PROJECTOR

Using the web control panel

The web control panel allows the user to configure various projector settings using a web browser from any personal computer or mobile devices.

System Requirements

To use the web control panel, make sure your devices and software meet the minimum system requirements.

- RJ45 cable (CAT-5e) or wireless dongle
- PC, laptop, mobile phone, or tablet installed with a web browser
- Compatible web browsers:
 - Microsoft Edge 40 or higher version
 - Firefox 57 or higher version
 - Chrome 63 or higher version

Overview of the web control panel

Configure the projector settings using web browser.

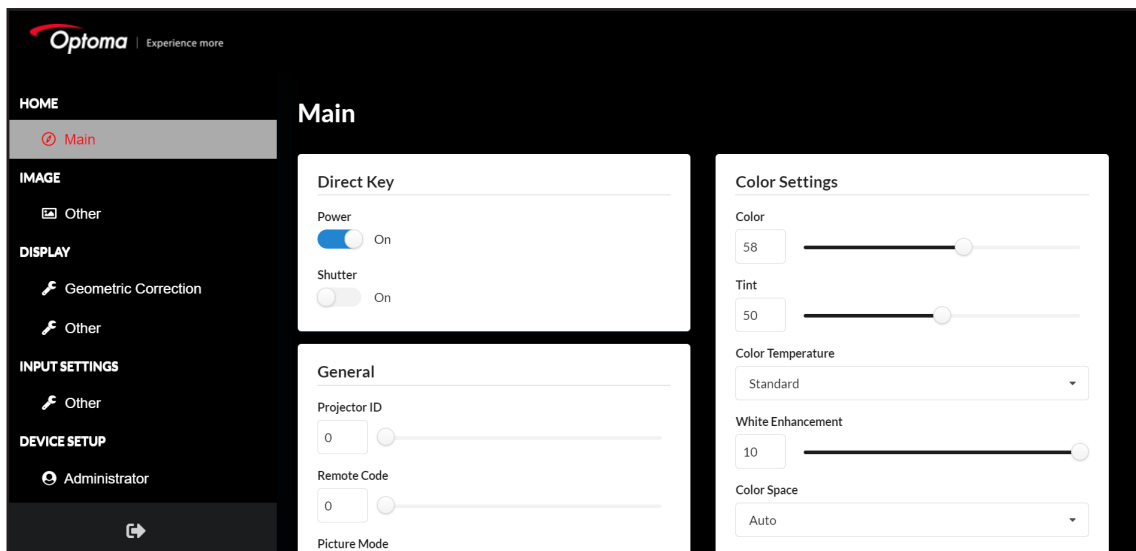

Menu	Description
HOME	View the projector information and firmware version details.
IMAGE	To configure image settings.
DISPLAY	To configure the settings to properly project images according to your installation circumstances.
INPUT SETTINGS	To configure the projector input settings.
DEVICE SETUP	To configure the system settings for the projector.
COMMUNICATION	Communication menu is used to configure the settings that allow the projector to communicate with other projectors or control devices.
INFORMATION	View the projector information about its status and settings. The projector information is read only.

USING THE PROJECTOR

Accessing the web control panel

When network is available, connect the projector and the computer to the same network. Use the projector address as the web URL to open the web control panel in a browser.

1. Check the projector address using the OSD menu.
 - On a wired network, select **Communication > Network Setup > IP Address**.
2. Open a web browser and type the projector address in the address bar.
3. The web page redirects to the web control panel.
4. In the Username field, type the username: admin (default) In the Password field, type the password.: Device serial number (default). Path: Menu -> Information -> Device -> Serial Number.

Note: *It is needed to change the username and password once you have logged in. It is also advised to use a strong password.*

When network is not available, refer to “Directly connect the projector to a computer” section.

Directly connect the projector to a computer

When network is not available, connect the projector to the computer directly using a RJ-45 cable, and configure the network settings manually.

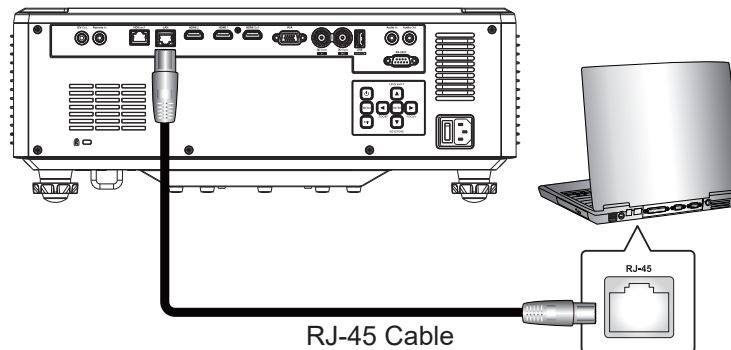

1. Assign IP address to the projector
 - From the OSD menu, select **Network Setup > DHCP**.
 - Turn off DHCP, and manually set the projector's IP Address, Subnet Mask, and Gateway.
 - Press **Enter** to confirm the settings.
2. Assign IP address to the computer
 - Set the Default Gateway and Subnet Mask of the computer to match the projector.
 - Set the IP address of the computer to match the first three numbers of the projector.
For example, if the projector IP address is 192.168.000.100, set the computer IP address to 192.168.000.xxx, where xxx is not 100.
3. Open a web browser and type the projector address in the address bar.
4. The web page redirects to the web control panel.

USING THE PROJECTOR

Using RS232 command by Telnet

This projector supports using RS232 commands through Telnet connection.

1. Set up a direct connection between the projector and computer. Refer to *Directly connect the projector to a computer* on page 65.
2. Disable the firewall on the computer.
3. Open the command dialogue on the computer. For Windows 7 operating system, select **Start > All Programs > Accessories > Command Prompt**.
4. Input the command "telnet ttt.xxx.yyy.zzz 23".
Replace "ttt.xxx.yyy.zzz" with the projector IP address.
5. Press **Enter** on the computer keyboard.

Specification for RS232 by Telnet

- Telnet: TCP
- Telnet port: 23 (contact service team for more details)
- Telnet utility: Windows "TELNET.exe" (console mode).
- Disconnection for RS232-by-Telnet control normally: Close
- Below are the limitations for using Windows Telnet utility directly after TELNET connection is ready:
 - There is less than 50 bytes for successive network payload for Telnet-Control application.
 - There is less than 26 bytes for one complete RS232 command for Telnet-Control.
 - Minimum delay for next RS232 command must be more than 200 (ms). Information menu.

Info menu

View the projector information about its status and settings. The projector information is read only.

Submenus

- Device
- System Status
- Communication
- Signal
- Firmware Version

ADDITIONAL INFORMATION

Compatible Resolutions

Digital

HDMI 2.0		
Established Timing	Standard Timing	Detail Timing
640 x 480 @ 60Hz	800 x 600 @ 120Hz	640 x 480 @ 60Hz
640 x 480 @ 67Hz	1280 x 768 @ 120Hz	720 x 480 @ 60Hz
640 x 480 @ 72Hz	1280 x 800 @ 75Hz	720 x 576 @ 50Hz
640 x 480 @ 75Hz	1280 x 1024 @ 60Hz	720 x 480i @ 60Hz
720 x 400 @ 70Hz	1360 x 765 @ 60Hz	720 x 576i @ 50Hz
720 x 400 @ 88Hz	1400 x 1050 @ 60Hz	1280 x 720 @ 50Hz
800 x 600 @ 56Hz	1600 x 1200 @ 60Hz	1280 x 720 @ 60Hz
800 x 600 @ 60Hz	1680 x 1050 @ 60Hz	1280 x 720 @ 120Hz
800 x 600 @ 72Hz		1440 x 480 @ 60Hz
800 x 600 @ 75Hz		1920 x 1080 @ 24Hz
832 x 624 @ 75Hz		1920 x 1080 @ 25Hz
1024 x 768 @ 60Hz		1920 x 1080 @ 50Hz
1024 x 768 @ 70Hz		1920 x 1080 @ 60Hz
1024 x 768 @ 75Hz		1920 x 1080 @ 120Hz
1152 x 870 @ 75Hz		1920 x 1080i @ 50Hz
1280 x 1024 @ 75Hz		1920 x 1080i @ 60Hz
		1920 x 1200 @ 59Hz
		3840 x 2160 @ 24Hz
		3840 x 2160 @ 25Hz
		3840 x 2160 @ 30Hz
		3840 x 2160 @ 50Hz
		3840 x 2160 @ 60Hz
		4096 x 2160 @ 24Hz
		4096 x 2160 @ 25Hz
		4096 x 2160 @ 30Hz
		4096 x 2160 @ 50Hz
		4096 x 2160 @ 60Hz

ADDITIONAL INFORMATION

HDMI 1.4		
Established Timing	Standard Timing	Detail Timing
640 x 480 @ 60Hz	800 x 600 @ 120Hz	640 x 480 @ 60Hz
640 x 480 @ 67Hz	1280 x 768 @ 120Hz	720 x 480 @ 60Hz
640 x 480 @ 72Hz	1280 x 800 @ 75Hz	720 x 576 @ 50Hz
640 x 480 @ 75Hz	1280 x 1024 @ 60Hz	720 x 480i @ 60Hz
720 x 400 @ 70Hz	1360 x 765 @ 60Hz	720 x 576i @ 50Hz
720 x 400 @ 88Hz	1400 x 1050 @ 60Hz	1280 x 720 @ 50Hz
800 x 600 @ 56Hz	1600 x 1200 @ 60Hz	1280 x 720 @ 60Hz
800 x 600 @ 60Hz	1680 x 1050 @ 60Hz	1440 x 480 @ 60Hz
800 x 600 @ 72Hz		1920 x 1080 @ 24Hz
800 x 600 @ 75Hz		1920 x 1080 @ 25Hz
832 x 624 @ 75Hz		1920 x 1080 @ 50Hz
1024 x 768 @ 60Hz		1920 x 1080 @ 60Hz
1024 x 768 @ 70Hz		1920 x 1080i @ 50Hz
1024 x 768 @ 75Hz		1920 x 1080i @ 60Hz
1152 x 870 @ 75Hz		1920 x 1200 @ 59Hz
1280 x 1024 @ 75Hz		

Analog

Analog		
Established Timing	Standard Timing	Detail Timing
640 x 480 @ 60Hz	1280 x 800 @ 75Hz	1920 x 1080 @ 60Hz
640 x 480 @ 67Hz	1280 x 1024 @ 60Hz	1920 x 1200 @ 59Hz
640 x 480 @ 72Hz	1360 x 765 @ 60Hz	
640 x 480 @ 75Hz	1400 x 1050 @ 60Hz	
720 x 400 @ 70Hz	1440 x 900 @ 60Hz	
720 x 400 @ 88Hz	1440 x 900 @ 75Hz	
800 x 600 @ 56Hz	1600 x 1200 @ 60Hz	
800 x 600 @ 60Hz	1680 x 1050 @ 60Hz	
800 x 600 @ 72Hz		
800 x 600 @ 75Hz		
832 x 624 @ 75Hz		
1024 x 768 @ 60Hz		
1024 x 768 @ 70Hz		
1024 x 768 @ 75Hz		
1152 x 870 @ 75Hz		
1280 x 1024 @ 75Hz		

ADDITIONAL INFORMATION

True 3D video compatibility

		Input timing	
Input Resolutions	HDMI 1.4a 3D Input	1280 x 720P @ 50Hz	Top and Bottom
		1280 x 720P @ 60Hz	Top and Bottom
		1280 x 720P @ 50Hz	Frame Packing
		1280 x 720P @ 60Hz	Frame Packing
		1920 x 1080P @ 24Hz	Top and Bottom
		1920 x 1080P @ 24Hz	Frame Packing
		1920 x 1080i @ 50Hz	Side by Side
		1920 x 1080i @ 60Hz	Side by Side
		1024 x 768 @ 120Hz	Frame Sequential
		1280 x 720 @ 120Hz	Frame Sequential
		1280 x 800 @ 120Hz	Frame Sequential
		1920 x 1080P @ 60Hz	Frame Sequential
		1920 x 1080P @ 120Hz	Frame Sequential
		1920 x 1200 @ 60Hz	Frame Sequential
		800 x 600 @ 120Hz	Frame Sequential

Note: If 3D input is 1080p@24Hz, the DMD should replay with integral multiple with 3D mode.

ADDITIONAL INFORMATION

RS232 Port Setting and Signals Connection

RS232 Port Setting

Items	Method
Communication Method	Asynchronous Communication
Baud Rate	115200
Data Bits	8 bits
Parity	None
Stop Bits	1
Flow Control	None

RS232 Signals Connection

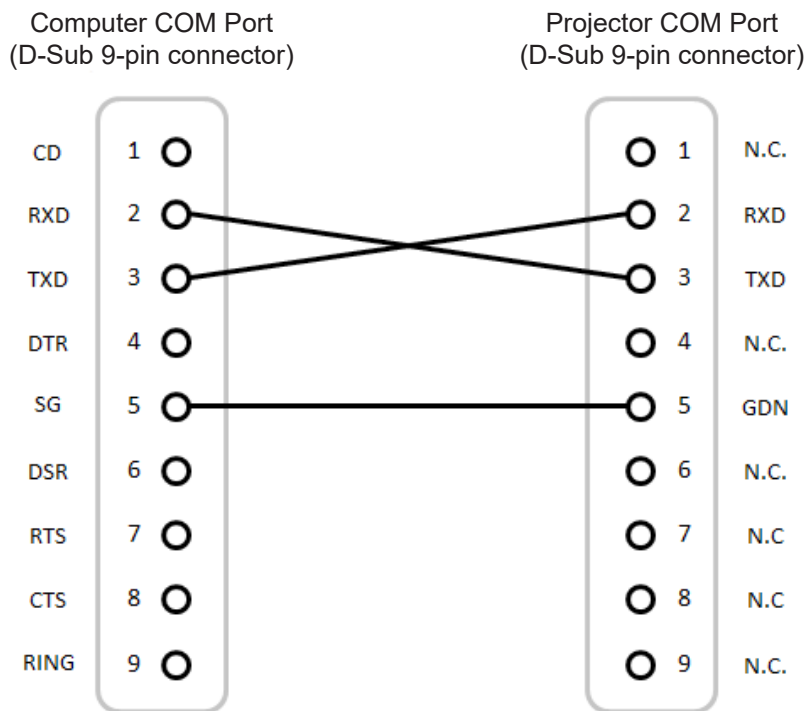

Note: RS232 shell is grounded.

ADDITIONAL INFORMATION

Image Size and Projection Distance

1.6x lens model

The size of projected images is 50 ~ 300 inches (1.27 ~ 7.62 m)

Screen Size 16:10 (Wx H)						Projector Distance			
Diagonal Length of Image		Width		Height		Wide		Tele	
inch	m	inch	m	inch	m	inch	m	inch	m
50	1.27	42.4	1.08	26.5	0.67	52.3	1.33	84.0	2.13
60	1.52	50.9	1.29	31.8	0.81	63.1	1.60	101.2	2.57
70	1.78	59.4	1.51	37.1	0.94	74.0	1.88	118.4	3.01
80	2.03	67.8	1.72	42.4	1.08	84.8	2.15	135.6	3.44
90	2.29	76.3	1.94	47.7	1.21	95.7	2.43	152.8	3.88
100	2.54	84.8	2.15	53.0	1.35	106.5	2.71	170.0	4.32
120	3.05	101.8	2.58	63.6	1.62	128.3	3.26	204.4	5.19
150	3.81	127.2	3.23	79.5	2.02	160.8	4.09	256.0	6.50
180	4.57	152.6	3.88	95.4	2.42	193.4	4.91	307.6	7.81
200	5.08	169.6	4.31	106.0	2.69	215.1	5.46	342.0	8.69
250	6.35	212.0	5.38	132.5	3.37	269.4	6.84	428.0	10.87
300	7.62	254.4	6.46	159.0	4.04	323.7	8.22	514.0	13.06

1.15x lens model

The size of projected images is 50 ~ 1000 inches (1.27 ~ 25.4 m)

Screen Size 16:10 (Wx H)						Projector Distance			
Diagonal Length of Image		Width		Height		Wide		Tele	
inch	m	inch	m	inch	m	inch	m	inch	m
50	1.27	42.4	1.08	26.5	0.67	27.0	0.69	31.3	0.79
60	1.52	50.9	1.29	31.8	0.81	32.7	0.83	37.8	0.96
70	1.78	59.4	1.51	37.1	0.94	38.4	0.98	44.4	1.13
80	2.03	67.8	1.72	42.4	1.08	44.1	1.12	50.9	1.29
90	2.29	76.3	1.94	47.7	1.21	49.8	1.27	57.5	1.46
100	2.54	84.8	2.15	53.0	1.35	55.5	1.41	64.1	1.63
120	3.05	101.8	2.58	63.6	1.62	66.9	1.70	77.2	1.96
150	3.81	127.2	3.23	79.5	2.02	84.0	2.13	96.9	2.46
180	4.57	152.6	3.88	95.4	2.42	101.2	2.57	116.6	2.96
200	5.08	169.6	4.31	106.0	2.69	112.6	2.86	129.7	3.29
250	6.35	212.0	5.38	132.5	3.37	141.1	3.58	162.5	4.13
300	7.62	254.4	6.46	159.0	4.04	169.6	4.31	195.3	4.96
350	8.89	296.8	7.54	185.5	4.71	198.2	5.03	228.1	5.79
400	10.16	339.2	8.62	212.0	5.38	226.7	5.76	260.9	6.63
500	12.7	424.0	10.77	265.0	6.73	283.7	7.21	326.5	8.29
600	15.24	508.8	12.92	318.0	8.08	340.8	8.66	392.1	9.96
700	17.78	593.6	15.08	371.0	9.42	397.9	10.11	457.8	11.63

ADDITIONAL INFORMATION

Screen Size 16:10 (Wx H)						Projector Distance			
Diagonal Length of Image		Width		Height		Wide		Tele	
inch	m	inch	m	inch	m	inch	m	inch	m
800	20.32	678.4	17.23	424.0	10.77	454.9	11.55	523.4	13.30
900	22.86	763.2	19.39	477.0	12.12	512.0	13.00	589.0	14.96
1000	25.4	848.0	21.54	530.0	13.46	569.0	14.45	654.6	16.63

Fixed lens model

The size of projected images is 40 ~ 300 inches (1.02 ~ 7.62 m)

Screen Size 16:10 (Wx H)						Projector Distance	
Diagonal Length of Image		Width		Height		Fixed	
inch	m	inch	m	inch	m	inch	m
40	1.02	33.9	0.86	21.2	0.54	24.4	0.54
50	1.27	42.4	1.08	26.5	0.67	29.8	0.68
60	1.52	50.9	1.29	31.8	0.81	35.1	0.82
70	1.78	59.4	1.51	37.1	0.94	40.5	0.95
80	2.03	67.8	1.72	42.4	1.08	45.8	1.09
90	2.29	76.3	1.94	47.7	1.21	51.2	1.22
100	2.54	84.8	2.15	53.0	1.35	56.5	1.36
120	3.05	101.8	2.58	63.6	1.62	67.3	1.71
150	3.81	127.2	3.23	79.5	2.02	83.2	2.04
180	4.57	152.6	3.88	95.4	2.42	99.4	2.53
200	5.08	169.6	4.31	106.0	2.69	111.0	2.74
250	6.35	212.0	5.38	132.5	3.37	136.9	3.48
300	7.62	254.4	6.46	159.0	4.04	163.3	4.07

ADDITIONAL INFORMATION

Ceiling Mount Installation

1. To prevent damage to your projector, please use the Optoma ceiling mount.
2. If you wish to use a third party ceiling mount kit, please ensure the screws used to attach a mount to the projector meet the following specifications:
 - Screw type: M4*4
 - Minimum screw length: 8 mm

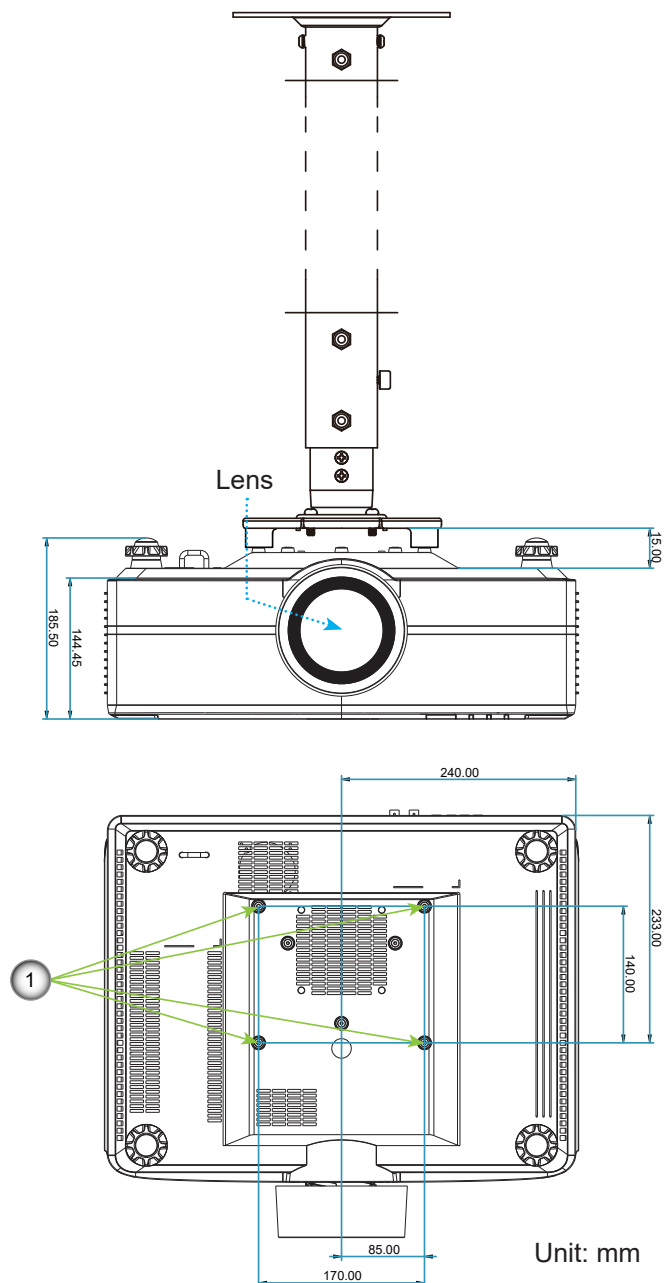

Note:

1. Mounting holes for ceiling mount.
2. Please note that damage resulting from incorrect installation will void the warranty.

ADDITIONAL INFORMATION

IR remote codes

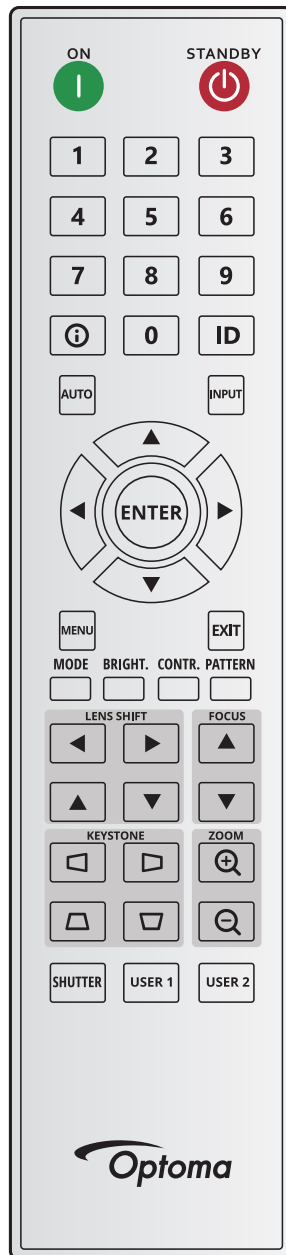

Key Legend	Key Position	Repeat Format	Address		Data		Description
			Byte 1	Byte 2	Byte 3	Byte 4	
ON (I)	1	F1	32	CD	2	FD	Press to turn on the projector.
OFF (⏻)	2	F1	32	CD	2E	D1	Press to turn off the projector.
1	3	F1	32	CD	72	8D	Use as numeric keypad number "1".
2	4	F1	32	CD	73	8C	Use as numeric keypad number "2".
3	5	F1	32	CD	74	8B	Use as numeric keypad number "3".
4	6	F1	32	CD	75	8A	Use as numeric keypad number "4".
5	7	F1	32	CD	77	88	Use as numeric keypad number "5".
6	8	F1	32	CD	78	87	Use as numeric keypad number "6".

ADDITIONAL INFORMATION







Key Legend	Key Position	Repeat Format	Address		Data		Description
			Byte 1	Byte 2	Byte 3	Byte 4	
7	9	F1	32	CD	79	86	Use as numeric keypad number "7".
8	10	F1	32	CD	80	7F	Use as numeric keypad number "8".
9	11	F1	32	CD	81	7E	Use as numeric keypad number "9".
Info (i)	12	F1	32	CD	82	7D	Press to display source image information.
0	13	F1	32	CD	25	DA	Use as numeric keypad number "0".
ID	14	F1	32	CD	A7	58	Press to set remote ID. Please refer to "Remote control ID setup" on page 26.
Auto	15	F1	32	CD	4	FB	Press to automatically synchronize the projector to the input source.
Input	16	F1	32	CD	18	E7	Press to select an input signal.
UP ()	17	F1	32	CD	0F	F0	Press to select items or make adjustments to our selection.
LEFT ()	18	F1	32	CD	11	EE	Press to select items or make adjustments to our selection.
Enter	19	F1	32	CD	14	EB	Press to confirm your item selection.
RIGHT ()	20	F1	32	CD	10	EF	Press to select items or make adjustments to our selection.
DOWN ()	21	F1	32	CD	12	ED	Press to select items or make adjustments to our selection.
Menu	22	F1	32	CD	0E	F1	Press to display the on-screen display menus for projector.
Exit	23	F1	32	CD	2A	D5	Press to return to previous level or exit menus if at top level.
Mode	24	F1	32	CD	5	FA	Press to select the preset display mode.
Bright.	25	F1	32	CD	28	D7	Press to adjust amount of light in the image.
Contr.	26	F1	32	CD	29	D6	Press to adjust difference between dark and light.
Pattern	27	F1	32	CD	58	A7	Press to display a test pattern.
Lens Shift	28	F1	32	CD	41	BE	Press to adjust the position of the image horizontally.
Lens Shift	29	F1	32	CD	42	BD	
Focus	30	F1	32	CD	86	79	Press to adjust focus to improve image clarity as desired.
Lens Shift	31	F1	32	CD	34	CB	Press to adjust the position of the image vertically.
Lens Shift	32	F1	32	CD	32	CD	Press to adjust the position of the image vertically.
Focus	33	F1	32	CD	26	D9	Press to adjust focus to improve image clarity as desired.
Keystone ▤	34	F1	32	CD	87	78	Press to adjust the horizontal keystone.
Keystone ▥	35	F1	32	CD	51	AE	Press to adjust the horizontal keystone.
Zoom ⊕	36	F1	32	CD	52	AD	Press to adjust zoom to achieve a desired image size.
Keystone ▨	37	F1	32	CD	53	AC	Press to adjust the vertical keystone.
Keystone ▩	38	F1	32	CD	54	AB	Press to adjust the vertical keystone.
Zoom ⊖	39	F1	32	CD	55	AA	Press to adjust zoom to achieve a desired image size.
Shutter (AV Mute)	40	F1	32	CD	56	A9	Press to hide/unhide the screen picture.
User 1	41	F1	32	CD	57	A8	Press to assign user functions. Please refer to "Remote Setup" on page 69.
User 2	42	F1	32	CD	27	D8	Press to assign user functions. Please refer to "Remote Setup" on page 69.

ADDITIONAL INFORMATION

Troubleshooting

If you experience a problem with your projector, please refer to the following information. If a problem persists, please contact your local reseller or service center.

Image problems

- ❓ *No image appears on-screen*
 - Ensure all the cables and power connections are correctly and securely connected as described in the *Setup and Installation* section.
 - Ensure the pins of connectors are not crooked or broken.
 - Ensure that the Shutter (AV Mute) feature is not turned on.
- ❓ *Image is out of focus*
 - Press the **Focus** or **Focus** button on the remote control or projector keypad to adjust the focus until the image is sharp and legible.
 - Make sure the projection screen is between the required distance from the projector. (Please refer to *Image size and projection distance* page 96).
- ❓ *The image is stretched when displaying 16:10 DVD title*
 - When you play anamorphic DVD or 16:10 DVD, the projector will show the best image in 16:10 format on projector side.
 - If you play 4:3 format DVD title, please change the format as 4:3 in projector OSD.
 - Please setup the display format as 16:10 (wide) aspect ratio type on your DVD player.
- ❓ *Image is too small or too large*
 - Press the **Zoom**  or **Zoom**  button on the remote control or projector keypad to adjust the projected image size.
 - Move the projector closer to or further from the screen.
 - From the OSD menu, select **Display > Aspect Ratio** to change the aspect ratio.
- ❓ *Image has slanted sides:*
 - If possible, reposition the projector so that it is centered on the screen and below the bottom of the screen.
 - Press the **Keystone**     buttons on the remote control to adjust the screen shape.
- ❓ *Image is reversed*
 - From the OSD menu, select **Device Setup > Projection > Rear** to reverse the image so you can project from behind a translucent screen.

Other problems

- ❓ *The projector stops responding to all controls*
 - If possible, turn off the projector, then unplug the power cord and wait at least 20 seconds before reconnecting power.

Remote control problems

- ❓ *If the remote control does not work*
 - Check that the operating angle of the remote control is pointed within $\pm 30^\circ$ to the IR receivers on the projector.
 - Make sure there are not any obstructions between the remote control and the projector. Move to within 20 meters (65.6 feet) of the projector.
 - Make sure batteries are inserted correctly.
 - Replace batteries if they are exhausted.

ADDITIONAL INFORMATION

LED Indicators and Lightning Messages

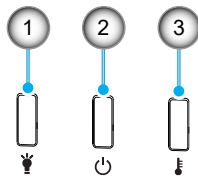

No.	Item
1.	Light LED
2.	Power LED
3.	Temp LED

Status	Light LED	Power LED		Temp LED
	Red	Red	Green	Red
Standby	N/A	Steady light	N/A	N/A
Power On	N/A	N/A	Steady light	N/A
Warning Up Start	N/A	Flashing (1 sec off / 1 sec on)	N/A	N/A
Cooling Down Start	N/A	N/A	Flashing (0.5 sec off / 0.5 sec on)	N/A
AV Mute	Flashing (1 sec off / 1 sec on)	N/A	Steady light	N/A
Error (Power Failure)	Steady light	N/A	N/A	Steady light
Error (Fan Failure)	N/A	N/A	N/A	Flashing (3 sec on / 3 sec off)
Error (Color Wheel Breakdown)	N/A	N/A	N/A	Flashing (0.5 sec off / 0.5 sec on)
Error (Over Temp)	N/A	N/A	N/A	Steady light
Error (LD Over Temp)	N/A	N/A	N/A	Steady light
Error (LD Voltage Failure)	Steady light	N/A	N/A	N/A
Error (Temp Sensor Disconnect)	Flashing (0.5 sec off / 0.5 sec on)	Flashing (0.5 sec off / 0.5 sec on)	N/A	N/A
Error (LD Failure)	Steady light	N/A	Steady light	N/A
Upgrade Process	Flashing (3 sec off / 3 sec on)	Flashing (3 sec off / 3 sec on)	Flashing (3 sec off / 3 sec on)	Flashing (3 sec off / 3 sec on)

Note: The light off for 10min when projector into upgrade process and All LED Flashing (3 sec off/ 3 sec on)

ADDITIONAL INFORMATION

Specifications

Optical	Description		
Lens type	1.6x	1.15x	Fixed
Throw ratio	1.25~2.0	0.65~0.75	0.63
Maximum resolution	WUXGA	WUXGA	WUXGA
Zoom & focus adjustment	Power	Power	Power
Image size (diagonal)	50"~300"	50"~1000"	40"~300"

Electrical	Description
Inputs	<ul style="list-style-type: none"> - HDMI 1 v2.0/4K - HDMI 2 v2.0/v1.4a - VGA-IN - 3D SYNC IN - USB Type-A x1 - AUDIO-IN 3.5mm
Outputs	<ul style="list-style-type: none"> - HDMI OUT - 3D SYNC OUT - AUDIO-OUT 3.5mm - 12V OUT Trigger
Control	<ul style="list-style-type: none"> - Wired IR - HDBaseT - RJ-45 (support web control) - RS232
Color reproduction	1073.4 Million color
Scan rate	<ul style="list-style-type: none"> - Horizontal scan rate: 15.38 ~ 91.15 KHz - Vertical scan rate: 24 ~ 85 Hz (120 Hz for 3D feature)
Built-in speaker	2x 10W speakers
Power requirement	100 - 240V ±10%, AC 50/60Hz
Power Consumption	<ul style="list-style-type: none"> - Normal mode: 520W ± 15% @ 110Vac / 505W ± 15% @ 220Vac - ECO mode: 265W ± 15% @ 110Vac / 260W ± 15% @ 220Vac
Input current	6.5A
Installation orientation	Front, Rear, Ceiling-top, and Rear-top
Dimensions (W x D x H)	1.6x lens model: <ul style="list-style-type: none"> - 486 x 432.5 x 176.0 mm (w/o feet) - 486 x 432.5 x 185.5 mm (with feet) 1.15x lens model: <ul style="list-style-type: none"> - 486 x 427.5 x 176.0 mm (w/o feet) - 486 x 427.5 x 185.5 mm (with feet) Fixed lens model: <ul style="list-style-type: none"> - 486 x 417.4 x 176.0 mm (w/o feet) - 486 x 417.4 x 185.5 mm (with feet)
Weight	14 ± 0.5 Kg
Environmental conditions	Operating in 5 ~ 40°C , 10% to 85% humidity (non-condensing)

Note: All specifications are subject to change without notice.

ADDITIONAL INFORMATION

RS232 protocol function list

Baud Rate : 115200

Data Bits: 8

Parity: None

Stop Bits: 1

Flow Control : None

UART16550 FIFO: Disable

■ Write Command

~	X	X	X	X	X		n	CR
Lead Code	Projector ID		Command			space	variable	carriage return
Prefix	00~99 (Default: 00)		000~999				0~9999	suffix

Pass:

Fail:

■ Read Command

~	X	X	X	X	X		n	CR
Lead Code	Projector ID		Command			space	variable	carriage return
Prefix	00~99 (Default: 00)		000~999				0~9999	suffix

Response Format

Pass:

O	k	n
Variable		

 Fail:

■ System Automatically Send

I	N	F	O	n
				Variable

Note: There is a <CR> after all ASCII commands. 0D is the HEX code for <CR> in ASCII code.

ADDITIONAL INFORMATION

Level 1	Level 2	Level 3	Level 4	Level 5	Level 6	n value
Image	Picture Mode	Presentation				
		Bright				
		Cinema				
		HDR				
		sRGB				
		DICOM SIM				
		Standard				
		SD				
		SD High Speed				
		User				
	Dynamic Range	HDR	Off			
		Auto				
		Bright				
		Standard				
	HDR Picture Mode	From				
		Detail				
	Brightness	0~100				
		+				
	Contrast	0~100				
		+				
	Sharpness	1~15				
		Fin				
	Gamma	Gamma				
		Graphics				
		Standard(B.2)				
		Vivid				
		SD				
		Blackboard				
		DICOM SIM				
		1.8				
		2.0				
		2.4				
	2.6					
	Dynamic Contrast	Dynamic Black	Off			
		On				
		Speed	1~15			
		Strength	0~9			
		Level	50%~100%			
		Extreme Black	Off			
		On				
		AV Mode Timer	On~10s			
	Black Signal Level	0~5				
	Color	Color	0~100			
		Limit	0~10M			
		Warm				
		Standard				
		Cool				
		Color Wheel Speed	3K			
		3K				
		Red Gain	0~100			
		Green Gain	0~100			
		Blue Gain	0~100			
		Red Offset	0~100			
		Green Offset	0~100			
		Blue Offset	0~100			
		White Enhancement	Auto			
		Auto				
		Color Space	RGB (0-255)			
		RGB (16-235)				
		REC709				
		REC601				
		Color Settings	Auto Test Pattern	Off		
	On					
	Hue		0~254			
	Saturation		0~254			
	Red		Gain	0~254		
	Hue		0~254			
	Saturation		0~254			
	Green		Gain	0~254		
	Hue		0~254			
	Saturation		0~254			
	Blue		Gain	0~254		
	Hue		0~254			
	Saturation		0~254			
	Cyan		Gain	0~254		
	Hue		0~254			
	Saturation		0~254			
	Yellow		Gain	0~254		
	Hue		0~254			
	Saturation		0~254			

Write Command			Read Command		
Command			Command		
CMD	Set Para.		CMD	CMD Value	Para.
X020	1		X0123	1	0 k 0
X020	2		X0123	1	0 k 1
X020	3		X0123	1	0 k 2
X020	31		X0123	1	0 k 3
X020	4		X0123	1	0 k 4
X020	13		X0123	1	0 k 10
X020	17		X0123	1	0 k 10
X020	9		X0123	1	0 k 10
X020	18		X0123	1	0 k 18
X020	6,26,30,37		X0123	1	0 k 6,26,30,37
X0565	0				
X0565	1				
X0566	0				
X0566	1				
X0566	2				
X0566	3				
X046	1				
X021	0~100		X0125	1	0 k 0~100
X046	2				
X047	1				
X022	0~100		X0126	1	0 k 0~100
X047	2				
X023	2~15				
X05	1				
X05	3				
X020	4				
X05	21				
X020	9				
X020	10				
X020	11				
X020	5				
X020	12				
X020	8				
X020	0				
X020	1				
X023	1~15				
X024	0~3				
X025	50~100				
X028	0				
X028	1				
X028	0~20				
X027	0~5				
X045	0~100				
X044	0~100				
X036	4		X0128	1	0 k 3
X036	1		X0128	1	0 k 0
X036	2		X0128	1	0 k 1
X0547	1				
X024	0~100				
X025	0~100				
X026	0~100				
X027	0~100				
X028	0~100				
X029	0~100				
X034	0~10				
X037	1				
X037	2				
X037	4				
X037	5				
X037	6				
X0411	0				
X0411	1				
X0327	0~254				
X0333	0~254				
X0339	0~254				
X0339	0~254				
X0334	0~254				
X0340	0~254				
X0343	0~254				
X0335	0~254				
X0341	0~254				
X0330	0~254				
X0336	0~254				
X0342	0~254				
X0331	0~254				
X0337	0~254				
X0343	0~254				
X0332	0~254				

Note: Some commands are not supported, it depends on models.

ADDITIONAL INFORMATION

Level 1	Level 2	Level 3	Level 4	Level 5	Level 6	n value	Write Command		Read Command					
							Command	Set Para.	Command	CMD Value	Pass			
Wall Color	Magenta	Saturation	White	0	0	254	XX338	0	0					
			Black	0	0	254	XX344	0	0					
			Red	0	0	254	XX345	0	0					
			Green	0	0	254	XX346	0	0					
	White	Reset	Blue	0	0	254	XX347	0	0					
				XX325	1									
				XX356	0									
				XX356	1									
				XX356	7									
				XX356	3									
				XX356	4									
3D Setup	3D Mode	OFF	Active 3D	0	0		XX230	0						
			Auto	0	0		XX405	0						
			Frame Packing	0	0		XX405	7						
	3D Format	SIDE BY SIDE	Top and Bottom	0	0		XX405	2						
			Frame Sequential	0	0		XX405	3						
			DLP Link	0	0		XX230	1						
	3D Tech	3D Sync	3D	0	0		XX230	3						
			L	0	0		XX400	1						
			R	0	0		XX400	2						
	3D Sync Out	To Next Projector	OFF	0	0		XX232	0						
			To Emitter	0	0		XX232	1						
			ON	0	0		XX232	0						
	3D Invert	ON	0	0	0		XX233	1						
			1-200	0	0		XX233	1-500						
			Reset	0	0		XX234	1						
Apply to User	User Presentation	User-Right	31	31		XX123	1	D	L	31				
		User-Clarity	33	33		XX123	1	D	L	33				
		User-HDR	26	26		XX123	1	D	L	26				
		User-Refresh	34	34		XX123	1	D	L	34				
		User-DICOM SIM	35	35		XX123	1	D	L	35				
		User-Blending	36	36		XX123	1	D	L	36				
		User-IR	37	37		XX123	1	D	L	37				
		User-2D High Speed	37	37		XX123	1	D	L	37				
		Aspect Ratio	Auto	OFF	16:9	2	2		XX160	2	D	L	2	
					4:3	3	3		XX160	3	D	L	3	
5:3	5				5		XX160	5	D	L	5			
Native	6				6		XX160	6	D	L	6			
Digital Zoom	Proportional		ON	50% ~ 400%	0	0		XX364	0					
				50% ~ 400%	0	0		XX364	1					
	Horizontal		ON	50% ~ 400%	50	50		XX554	50-400					
				50% ~ 400%	50	50		XX555	50-400					
	Vertical		ON	50% ~ 400%	50	50		XX366	0	100				
				50% ~ 400%	50	50		XX366	0	100				
Image Shift	M. Position		ON	0	0	100		XX364	9					
				0	0	100		XX364	0	100				
	V. Position		ON	0	0	100		XX142	1					
				0	0	100		XX142	5					
	Basic Warp		Keystone	Horizontal	0	0	40		XX142	2				
					0	0	40		XX142	2				
Warp Control	Keystone	Horizontal	0	0	40		XX142	2						
			0	0	40		XX142	2						
	Pincushion	Horizontal	0	0	100		XX393	0	100					
			0	0	100		XX393	0	100					
		Vertical	right +1	1	1		XX359	1						
			up + 1	2	2		XX359	2						
	Four Corner	Top left	right +1	1	1		XX359	1						
			up + 1	3	3		XX359	3						
		Top right	right +1	5	5		XX359	5						
			up + 1	6	6		XX359	6						
	Bottom-left	right +1	7	7		XX359	7							
		down +1	8	8		XX359	8							
		right +1	9	9		XX359	9							
		down +1	10	10		XX359	10							
	Bottom-right	right +1	11	11		XX359	11							
		down +1	12	12		XX359	12							
right +1		13	13		XX359	13								
down +1		14	14		XX359	14								
Basic Warp	Keystone	Horizontal	0	0	40		XX359	15						
			0	0	40		XX359	16						

Note: Some commands are not supported, it depends on models.

ADDITIONAL INFORMATION

Level 1	Level 2	Level 3	Level 4	Level 5	Level 6	n value	Write Command			Read Command							
							Command	Hex	Set Para.	Command	CMD Value	Pass	Pass				
Display	Geometric Correction	Advanced Warp	Grid Color	Green	XX343	1	XX343	1									
				Magenta	XX344	2	XX344	2									
				Red	XX345	3	XX345	3									
				Cyan	XX346	4	XX346	4									
				Black	XX347	5	XX347	5									
				Transparent	XX348	6	XX348	6									
				Warp Setting	Dx2	XX344	1	XX344	1								
					Dx3	XX344	2	XX344	2								
					Dx5	XX344	3	XX344	3								
					Bx9	XX344	4	XX344	4								
					17x17	XX344	5	XX344	5								
					Off	XX346	0	XX346	0								
					On	XX346	1	XX346	1								
					Warp Sharpness	0-9	XX348	0-9	XX348	0-9							
					Blend Setting	Blend Width	4	XX369	1	XX369	1						
						6	XX369	2	XX369	2							
				8		XX369	3	XX369	3								
				10		XX369	4	XX369	4								
				12		XX369	5	XX369	5								
				L:8		XX370	1	XX370	1								
				L:9		XX370	2	XX370	2								
				L:9		XX370	3	XX370	3								
				L:3		XX370	4	XX370	4								
				L:2		XX370	5	XX370	5								
				Black Level	Area	Top	XX368	4/6	XX368	4/6							
					Enable	Off	XX368	3/5	XX368	3/5							
					Edit Area	On											
					Add Point												
					Remove Point												
					Brightness	0-255	XX263	1/2/3/4	XX263	1/2/3/4	XX272-XX273	1	D	L	min		
					Green	0-255	XX288-XX289	min	XX288-XX289	min	XX272-XX273	2	D	L	min		
					Blue	0-255	XX289-XX290	min	XX289-XX290	min	XX272-XX273	3	D	L	min		
					Exit												
					Reset	Bottom											
				Memory	Save Memory	Memory 1 - Memory 5	XX341	1-5	XX341	1-5							
					Apply Memory	Memory 1 - Memory 5	XX347	1-5	XX347	1-5							
					Clear Memory		XX374	1	XX374	1	XX337	1	D	L	1-5		
					Reset		XX363	1	XX363	1							
					Off		XX365	0-10	XX365	0-10							
					On		XX304	0	XX304	0							
					Unfreeze		XX304	1	XX304	1							
					Freeze		XX304	0	XX304	0							
					Off		XX395	0	XX395	0							
					Green Grid		XX395	3	XX395	3							
				Magenta Grid		XX395	4	XX395	4								
				White Grid		XX395	1	XX395	1								
				Black		XX395	2	XX395	2								
				Red		XX395	11	XX395	11								
				Green		XX395	5	XX395	5								
				Blue		XX395	6	XX395	6								
				Yellow		XX395	7	XX395	7								
				Magenta		XX395	8	XX395	8								
				Cyan		XX395	9	XX395	9								
				AMS Contrast 4x4		XX395	10	XX395	10								
				Color bar		XX395	14	XX395	14								
				Full screen		XX395	13	XX395	13								
				Screen	Off	XX302	0	XX302	0								
				Screen	On	XX302	1	XX302	1								
				Screen	PSP	XX302	2	XX302	2								
				Main Source	(no Signal)		XX312	5	XX312	5	XX321	1	D	L	0		
					VGA		XX312	1	XX312	1	XX321	1	D	L	1		
					HDMI1		XX312	15	XX312	15	XX321	1	D	L	5		
					HDMI2		XX312	21	XX312	21	XX321	1	D	L	16		
					HDMIeAT		XX305	1	XX305	1	XX331	1	D	L	0		
					(no Signal)		XX305	1	XX305	1	XX331	1	D	L	0		
					VGA		XX305	2	XX305	2	XX331	1	D	L	2		
					HDMI1		XX305	1	XX305	1	XX331	1	D	L	7		
					HDMI2		XX305	4	XX305	4	XX331	1	D	L	8		
					HDMIeAT		XX305	10	XX305	10	XX331	1	D	L	16		
				Swap		XX306	1	XX306	1								

Note: Some commands are not supported, it depends on models.

ADDITIONAL INFORMATION

Level 1	Level 2	Level 3	Level 4	Level 5	Level 6	n value	Write Command			Read Command						
							Command	Set Para.	Pass	Cmd	Cmd Value	Pass	Pass			
		Size	Small				XX304	3								
			Medium				XX304	2								
			Large				XX305	1								
			Location	PSP, Main Left				XX305	5							
				PSP, Main Top				XX305	6							
				PSP, Main Right				XX305	7							
				PSP, Main Bottom				XX305	8							
				PSP, Bottom Right				XX305	4							
				PSP, Bottom Left				XX305	3							
			Reset	PSP, Top Left				XX305	1							
				PSP, Top Right				XX305	2							
			Input Setup	Auto Source	Off				XX563	0						
					On				XX563	1						
				Quick Resync	Off				XX100	2						
					On				XX101	3						
				Active Inputs	VGA				XX408	5						
					HDMI1				XX408	3						
HDMI2						XX408	15									
HDBaseT						XX408	21									
Latency Adjustment	Normal					XX220	0									
	20 Ultra					XX220	1			XX113	1	O	L	O		
VGA	Phase	0°-300°				XX74	0°-100°									
	Resolution	(read only)				XX309	5									
HDMI	Output	HDMI 1		HDMI 2		XX309	6									
	HDMI 1 EDID	1.4				XX236	1									
	HDMI 2 EDID	1.4				XX236	2									
		1.4				XX237	1									
Language	Language	English					XX170	1								
		Deutsch					XX170	2								
		Francés					XX170	3								
		Italiano					XX170	4								
		Español					XX170	5								
		Português					XX170	6								
		Polski				XX170	7									
		Nederlands				XX170	8									
		한국어				XX170	10									
		繁體中文				XX170	11									
		简体中文				XX170	14									
		日本語				XX170	15									
		हिन्दी				XX170	16									
		Русский				XX170	17									
	Magyar				XX170	18										
	ไทย				XX170	19										
	Projection	Setting	Auto			XX523	3									
		On				XX523	2									
		Off				XX523	1									
		Rear	On			XX524	0									
		On				XX524	1									
		Off				XX524	2									
	Lens Settings	Focus	-				XX308	1								
			0				XX308	2								
			+				XX307	1								
							XX307	2								
		Zoom	Up				XX84	3								
			Down				XX84	4								
		Lens Shift	Left				XX84	5								
			Right				XX84	6								
Lens Shift Memory		Save Memory	Memory 1 ~ Memory 5			XX360	1~5									
		Apply Memory	Memory 1 ~ Memory 5			XX359	1~5									
Lens Calibration		Clear Memory				XX361	1									
						XX355	1			XX545	4	O	L	O		
Lens Lock		Lock				XX349	1			XX545	4	O	L	O		
		Unlock				XX349	2									
Date and Time	Reset				XX175	1										
	Date and Time	Off														
	Schedule Mode	Off				XX284	0									
	On					XX284	1									
	View Today	Monday														
		Tuesday														
		Wednesday														
		Thursday														
		Friday														
		Saturday														
	Sunday															
	Schedule Enable	Off				XX284	0'm									
	On					XX284	1'm									
	Time	00:00 ~ 23:59				XX471	d#hmmnaabb									
Off					XX471	d#hmmnaabb										

Note: Some commands are not supported, it depends on models.

ADDITIONAL INFORMATION

Level 1	Level 2	Level 3	Level 4	Level 5	Level 6	n value	Write Command		Read Command						
							CMD	Set Para.	CMD	CMD Value	Pass	Pass			
Device Setup	Schedule	Monday Tuesday Wednesday Thursday Friday Saturday Sunday	Event 01 08 Event 09 16	Function	Power Settings		XX471	dHmMmnaabb							
					Input Source		XX471	dHmMmnaabb							
					Light Source Mode		XX472	dHmMmnaabb							
					Shutter		XX473	dHmMmnaabb							
					Event	Off	XX471	dHmMmnaabb							
						Power On	XX472	dHmMmnaabb							
						Eco	XX471	dHmMmnaabb							
						Active	XX471	dHmMmnaabb							
					(Function + Power Settings)	Communication	XX471	dHmMmnaabb							
						VGA	XX471	dHmMmnaabb							
						HDMI	XX471	dHmMmnaabb							
						HDMI2	XX471	dHmMmnaabb							
						HDBaseT	XX471	dHmMmnaabb							
						Normal Mode	XX471	dHmMmnaabb							
						Ext Mode	XX471	dHmMmnaabb							
						Custom Brightness	XX471	dHmMmnaabb							
						(Function + Light Source Mode)	Shutter On	XX471	dHmMmnaabb						
							Shutter Off	XX472	dHmMmnaabb						
							Reset	XX472	dHmMmnaabb						
							Monday	XX473	1'n						
							Tuesday	XX471	2'n						
							Wednesday	XX473	3'n						
							Thursday	XX473	4'n						
							Friday	XX473	5'n						
							Saturday	XX473	6'n						
							Sunday	XX473	7'n						
							Reset	XX471	8'n						
							Reset Schedule	XX472	9						
							Reset the Day	XX474	1						
							Use NTP Server	XX474	3						
				Manual	XX474	3									
				XXX = 2037 (Year)	XX476	mm									
				01 ~ 12 (Month)	XX477	mm									
				01 ~ 31 (Day)	XX478	mm									
				00 ~ 59 (Hour)	XX479	mm									
				00 ~ 59 (Minute)	XX480	mm									
				Daylight Saving Time	On	XX481	1								
				Off	XX481	2									
				Time Zone	UTC+14:00	XX482	1								
					UTC+13:45	XX482	2								
					UTC+13:30	XX482	3								
					UTC+13:00	XX482	4								
					UTC+12:00	XX482	5								
					UTC+11:00	XX482	6								
					UTC+10:30	XX482	7								
					UTC+10:00	XX482	8								
					UTC+09:30	XX482	9								
					UTC+09:00	XX482	10								
					UTC+08:45	XX482	11								
					UTC+08:30	XX482	12								
					UTC+08:00	XX482	13								
					UTC+07:45	XX482	14								
					UTC+07:30	XX482	15								
					UTC+07:00	XX482	16								
					UTC+06:30	XX482	17								
					UTC+06:00	XX482	18								
					UTC+05:45	XX482	19								
					UTC+05:30	XX482	20								
					UTC+05:00	XX482	21								
					UTC+04:30	XX482	22								
					UTC+04:00	XX482	23								
					UTC+03:30	XX482	24								
					UTC+03:00	XX482	25								
					UTC+02:30	XX482	26								
					UTC+02:00	XX482	27								
					UTC+01:30	XX482	28								
					UTC+01:00	XX482	29								
					UTC+00:45	XX482	30								
					UTC+00:30	XX482	31								
					UTC+00:15	XX482	32								
					UTC+00:00	XX482	33								
					UTC-01:00	XX482	34								
					UTC-01:30	XX482	35								
					UTC-02:00	XX482	36								
					UTC-02:30	XX482	37								
					UTC-03:00	XX482	38								

Note: Some commands are not supported, it depends on models.

Note: Some commands are not supported, it depends on models.



ADDITIONAL INFORMATION

Optoma global offices

For service or support, please contact your local office.



USA

47697 Westinghouse Drive,
Fremont, CA 94539, USA
www.optomausa.com

 888-289-6786
 510-897-8601
 services@optoma.com



Canada

47697 Westinghouse Drive,
Fremont, CA 94539, USA
www.optomausa.com

 888-289-6786
 510-897-8601
 services@optoma.com



Latin America

47697 Westinghouse Drive,
Fremont, CA 94539, USA
www.optomausa.com

 888-289-6786
 510-897-8601
 services@optoma.com



Europe

Unit 1, Network 41, Bourne End Mills,
Hemel Hempstead, Herts,
HP1 2UJ, United Kingdom
www.optoma.eu
Service Tel : +44 (0)1923 691865

 +44 (0) 1923 691 800
 +44 (0) 1923 691 888
 service@tsc-europe.com



Benelux BV

Randstad 22-123
1316 BW Almere
The Netherlands
www.optoma.nl

 +31 (0) 36 820 0252
 +31 (0) 36 548 9052



France

Bâtiment E
81-83 avenue Edouard Vaillant
92100 Boulogne Billancourt, France

 +33 1 41 46 12 20
 +33 1 41 46 94 35
 savoptoma@optoma.fr



Spain

C/ José Hierro,36 Of. 1C
28522 Rivas VaciaMadrid,
Spain

 +34 91 499 06 06
 +34 91 670 08 32



Deutschland

Am Nordpark 3
41069 Mönchengladbach
Germany

 +49 (0) 2161 68643 0
 +49 (0) 2161 68643 99
 info@optoma.de

Scandinavia

Lerpeveien 25
3040 Drammen
Norway

 +47 32 98 89 90
 +47 32 98 89 99
 info@optoma.no

PO.BOX 9515
3038 Drammen
Norway

Korea

<https://www.optoma.com/kr/>

Japan



<https://www.optoma.com/jp/>

Taiwan

<https://www.optoma.com/tw/>

China

Room 2001, 20F, Building 4,
No. 1398 Kaixuan Road,
Changning District,
Shanghai, 200052, China
www.optoma.com.cn

 +86-21-62947376
 +86-21-62947375
 servicecn@optoma.com.cn

Australia

<https://www.optoma.com/au/>

