

# Panasonic®

## Operating Instructions Basic Guide

UHD LCD Display For business use

English

Model No.	TH-98SQ1W	98-inch model
	TH-86SQ1W	86-inch model
	TH-75SQ1W	75-inch model
	TH-65SQ1W	65-inch model
	TH-55SQ1W	55-inch model
	TH-49SQ1W	49-inch model

### Contents

Important Safety Instructions	2
FCC STATEMENT	3
Important Safety Notice	4
Safety Precautions	6
Precautions for use	9
Accessories	11
Cautions when moving	15
Eyebolt	16
Connections	17
Identifying Controls	21
Basic Controls	24
Specifications	26
Software License	29
PANASONIC PROFESSIONAL DISPLAY Limited Warranty	30
LIMITED WARRANTY STATEMENT	31
Customer Service	32

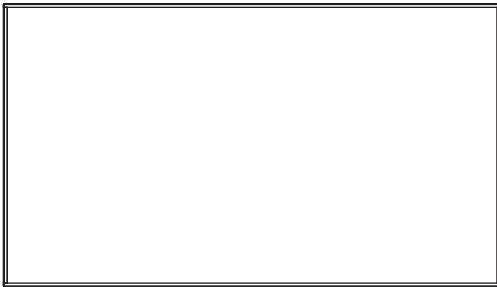

#### Read before use

For more information about this product, please read the “Operating Instructions – Functional Manual”.

To download the “Operating Instructions – Functional Manual”, please visit the Panasonic website (<https://panasonic.net/cns/prodisplays/>).

- Please read these instructions before operating your set and retain them for future reference.
- Illustrations and screens in this Operating Instructions are images for illustration purposes, and may be different from the actual ones.
- Descriptive illustrations in this Operating Instructions are created mainly based on the 98-inch model.



**4K**  
PROFESSIONAL  
\*Actual resolution:  
3840 × 2160p

**HDMI™**

**HEVC Advance™**  
Covered by patents at [patentlist.accessadvance.com](http://patentlist.accessadvance.com)



**WARNING**  
RISK OF ELECTRIC SHOCK  
DO NOT OPEN



**WARNING:** To reduce the risk of electric shock, do not remove cover or back.

**No user-serviceable parts inside. Refer servicing to qualified service personnel.**



The lightning flash with arrow-head within a triangle is intended to tell the user that parts inside the product are a risk of electric shock to persons.



The exclamation point within a triangle is intended to tell the user that important operating and servicing instructions are in the papers with the appliance.

**WARNING:**

**To prevent damage which may result in fire or shock hazard, do not expose this apparatus to rain or moisture.**

**Do not place containers with water (flower vase, cups, cosmetics, etc.) above the set. (including on shelves above, etc.)**

**WARNING:**

- 1) To prevent electric shock, do not remove cover. No user serviceable parts inside. Refer servicing to qualified service personnel.
- 2) Do not remove the grounding pin on the power plug. This apparatus is equipped with a three pin grounding-type power plug. This plug will only fit a grounding-type power outlet. This is a safety feature. If you are unable to insert the plug into the outlet, contact an electrician.  
Do not defeat the purpose of the grounding plug.

# Important Safety Instructions

- 1) Read these instructions.
- 2) Keep these instructions.
- 3) Heed all warnings.
- 4) Follow all instructions.
- 5) Do not use this apparatus near water.
- 6) Clean only with dry cloth.
- 7) Do not block any ventilation openings. Install in accordance with the manufacturer's instructions.
- 8) Do not install near any heat sources such as radiators, heat registers, stoves, or other apparatus (including amplifiers) that produce heat.
- 9) Do not defeat the safety purpose of the polarized or grounding-type plug. A polarized plug has two blades with one wider than the other. A grounding type plug has two blades and a third grounding prong. The wide blade or the third prong are provided for your safety. If the provided plug does not fit into your outlet, consult an electrician for replacement of the obsolete outlet.
- 10) Protect the power cord from being walked on or pinched particularly at plugs, convenience receptacles, and the point where they exit from the apparatus.
- 11) Only use attachments / accessories specified by the manufacturer.
- 12) Use only with the cart, stand, tripod, bracket, or table specified by the manufacturer, or sold with the apparatus. When a cart is used, use caution when moving the cart / apparatus combination to avoid injury from tip-over. 
- 13) Unplug this apparatus during lightning storms or when unused for long periods of time.
- 14) Refer all servicing to qualified service personnel. Servicing is required when the apparatus has been damaged in any way, such as power-supply cord or plug is damaged, liquid has been spilled or objects have fallen into the apparatus, the apparatus has been exposed to rain or moisture, does not operate normally, or has been dropped.
- 15) To prevent electric shock, ensure the grounding pin on the AC cord power plug is securely connected.

# FCC STATEMENT

This equipment has been tested and found to comply with the limits for a class A digital device, pursuant to Part 15 of the FCC Rules. These limits are designed to provide reasonable protection against harmful interference when the equipment is operated in a commercial environment. This equipment generates, uses and can radiate radio frequency energy and, if not installed and used in accordance with the instructions manual, may cause harmful interference to radio communications. Operation of this equipment in a residential area is likely to cause harmful interference in which case the user will be required to correct the interference at his own expense.

## FCC CAUTION:

**To assure continued compliance, follow the attached installation instructions and use only the provided power supply cord. Any changes or modifications not expressly approved by Panasonic Corp. of North America could void the user's authority to operate this device.**

Supplier's Declaration of Conformity

Model No.

TH-98SQ1W, TH-86SQ1W, TH-75SQ1W,  
TH-65SQ1W, TH-55SQ1W, TH-49SQ1W

Responsible Party:

Panasonic Corporation of North America  
Two Riverfront Plaza, Newark, New Jersey  
07102-5490

Contact Source:

Panasonic Connect North America  
1-877-655-2357

General Contact:

<http://shop.panasonic.com/support>

This device complies with Part 15 of the FCC Rules and all applicable IC RSS standards. Operation is subject to the following two conditions: (1) This device may not cause harmful interference, and (2) this device must accept any interference received, including interference that may cause undesired operation.

## CANADIAN NOTICE:

This Class A digital apparatus complies with Canadian ICES-003.

## WARNING:

- Not for use in a computer room as defined in the Standard for the Protection of Electronic Computer/ Data Processing Equipment, ANSI/NFPA 75.
- For permanently connected equipment, a readily accessible disconnect device shall be incorporated in the building installation wiring.
- For pluggable equipment, the socket-outlet shall be installed near the equipment and shall be easily accessible.

## Note:

Image retention may occur. If you display a still picture for an extended period, the image might remain on the screen. However, it will disappear when a general moving picture is displayed for a while.

## Trademark Credits

- Microsoft, Windows, Internet Explorer and Microsoft Edge are the registered trademarks or trademarks of Microsoft Corporation in the United States and/or other countries.
- Mac, macOS and Safari are the trademarks of Apple Inc. registered in the United States and other countries.
- PJLink is a registered or pending trademark in Japan, the United States, and other countries and regions.
- HDMI, High-Definition Multimedia Interface and the HDMI Logo are trademarks or registered trademarks of HDMI Licensing Administrator, Inc. in the United States and other countries.
- JavaScript is a registered trademark or a trademark of Oracle Corporation and its subsidiary and associated companies in the United States and/or other countries.
- Crestron Connected, Crestron Connected logo, Crestron Fusion, Crestron RoomView and RoomView are trademarks or registered trademarks of Crestron Electronics, Inc. in the United States and/or other countries.

Even if no special notation has been made of company or product trademarks, these trademarks have been fully respected.

# Important Safety Notice

## WARNING

- 1) To prevent damage which may result in fire or shock hazard, do not expose this appliance to dripping or splashing.  
Do not place containers with water (flower vase, cups, cosmetics, etc.) above the set. (including on shelves above, etc.)  
No naked flame sources, such as lighted candles, should be placed on / above the set.
- 2) To prevent electric shock, do not remove cover. No user serviceable parts inside. Refer servicing to qualified service personnel.
- 3) Do not remove the earthing pin on the power plug. This apparatus is equipped with a three pin earthing-type power plug. This plug will only fit an earthing-type power outlet. This is a safety feature. If you are unable to insert the plug into the outlet, contact an electrician.  
Do not defeat the purpose of the earthing plug.
- 4) To prevent electric shock, ensure the earthing pin on the AC cord power plug is securely connected.

## CAUTION

This appliance is intended for use in environments which are relatively free of electromagnetic fields.

Using this appliance near sources of strong electromagnetic fields or where electrical noise may overlap with the input signals could cause the picture and sound to wobble or cause interference such as noise to appear.

To avoid the possibility of harm to this appliance, keep it away from sources of strong electromagnetic fields.

## WARNING:

This equipment is compliant with Class A of CISPR32. In a residential environment this equipment may cause radio interference.

## IMPORTANT INFORMATION: Stability Hazard

Never place a display in an unstable location. A display may fall, causing serious personal injury or death. Many injuries, particularly to children, can be avoided by taking simple precautions such as:

- Using cabinets or stands recommended by the manufacturer of the display.
- Only using furniture that can safely support the display.
- Ensuring the display is not overhanging the edge of the supporting furniture.
- Not placing the display on tall furniture (for example, cupboards or bookcases) without anchoring both the furniture and the display to a suitable support.
- Not placing the display on cloth or other materials that may be located between the display and supporting furniture.
- Educating children about the dangers of climbing on furniture to reach the display or its controls.

If the existing display is going to be retained and relocated, the same considerations as above should be applied.

**IMPORTANT: THE MOULDED PLUG  
FOR YOUR SAFETY, PLEASE READ THE  
FOLLOWING TEXT CAREFULLY.**

This display is supplied with a moulded three pin mains plug for your safety and convenience. A 10 amp fuse is fitted in this plug. Shall the fuse need to be replaced, please ensure that the replacement fuse has a rating of 10 amps and that it is approved by ASTA or BSI to BS1362.

Check for the ASTA mark  or the BSI mark  on the body of the fuse.

If the plug contains a removable fuse cover, you must ensure that it is refitted when the fuse is replaced.

If you lose the fuse cover the plug must not be used until a replacement cover is obtained.

A replacement fuse cover can be purchased from your local Panasonic dealer.

Do not cut off the mains plug.

Do not use any other type of mains lead except the one supplied with this display.

The supplied mains lead and moulded plug are designed to be used with this display to avoid interference and for your safety.

If the socket outlet in your home is not suitable, get it changed by a qualified electrician.

If the plug or mains lead becomes damaged, purchase a replacement from an authorized dealer.

**WARNING : — THIS DISPLAY MUST BE EARTHED**

**How to replace the fuse.**

Open the fuse compartment with a screwdriver and replace the fuse.

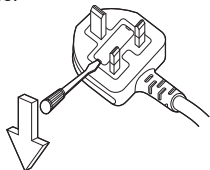

# Safety Precautions

## WARNING

### ■ Setup

**This LCD Display is for use only with the following optional accessories.**

**Use with any other type of optional accessories may cause instability which could result in the possibility of injury.**

**Securely install the pedestal and wall hanging bracket of the optional accessories. Ask an authorized dealer for installation.**

The following number of people are required for installation.

98-inch model 86-inch model 75-inch model :  
4 or more

65-inch model 55-inch model 49-inch model :  
2 or more

- Pedestal  
TY-ST75PE9 (75-inch model)  
TY-ST55PE9 (65-inch model 55-inch model)  
TY-ST43PE9 (49-inch model)
- Wall hanging bracket\*1  
TY-WK98PV1  
(98-inch model 86-inch model 75-inch model  
65-inch model)
- 3G-SDI Terminal Board\*2  
TY-SB01SS
- Digital Interface Box  
ET-YFB100G
- DIGITAL LINK Switcher  
ET-YFB200G
- Early Warning Software  
(Basic license/3-year license):  
ET-SWA100 series\*3
- Video Wall Manager  
Auto Display Adjustment Upgrade Kit  
TY-VUK10\*4

\*1: This product can be purchased in the U.S. and Japan.

\*2: This terminal board is supported only when the main software version of the display is 3.5000 or later and the sub software version of the display is 03.50 or later.

For update, please contact your Panasonic dealer.

\*3: Suffix of the part number may differ depending on the license type.

\*4: 98-inch model 86-inch model  
Supports Ver.1.10 or later.

75-inch model  
Supports Ver.1.12.1 or later.

65-inch model 55-inch model 49-inch model  
Supports Ver.1.11 or later.

### Note

- The part number of the optional accessories are subject to change without notice.

When installing the pedestal or wall hanging bracket, read the operating instructions supplied with it carefully and install properly. Also, always use the overturn prevention accessories.

We are not responsible for any product damage, etc. caused by failures in the installation environment for the pedestal or wall hanging bracket even during the warranty period.

Small parts can present choking hazard if accidentally swallowed. Keep small parts away from young children. Discard unneeded small parts and other objects, including packaging materials and plastic bags/sheets to prevent them from being played with by young children, creating the potential risk of suffocation.

**Do not place the Display on sloped or unstable surfaces, and ensure that the Display does not hang over the edge of the base.**

- The Display may fall off or tip over.

**Install this unit at a location with minimal vibration and which can support the weight of the unit.**

- Dropping or falling of the unit may cause injury or malfunction.

**Caution - For use only with UL Listed Wall Mount Bracket with minimum weight/load 90.0 kg (198.5 lbs).**

**When installing the display vertically, be sure that the power indicator comes to the right side.**

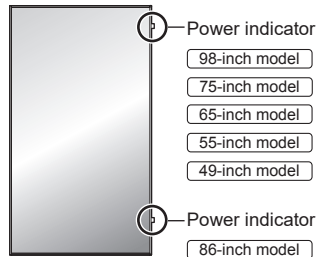

- If installed in different directions, heat is generated and it may cause fire or damage to the Display.

**When installing the unit (65-inch model 55-inch model 49-inch model) with its liquid crystal panel facing upright, ask your local Panasonic dealer.**

**For 98/86/75-inch models, do not position the unit with its liquid crystal panel facing upright.**

- There are conditions of mounting method, environmental temperature, connections and settings. If installed in different conditions, heat is generated and it may cause fire or damage to the Display.

### Cautions for Wall or Pedestal Installation

- The installation should be performed by an installation professional. Installing the Display incorrectly may lead to an accident that results in death or serious injury. Use the optional Pedestal. (see page 6)

- When installing on a wall, the specified wall hanging bracket (optional accessory) or a wall hanging bracket that conforms to VESA standards must be used.

98-inch model : VESA 800 × 500

86-inch model 75-inch model : VESA 600 × 400

65-inch model 55-inch model 49-inch model :

VESA 400 × 400

(see page 9)

- Before installation, be sure to check if the mounting location has enough strength to support the weight of the display and the wall hanging bracket for anti drop.
- If you terminate the use of the product, ask a professional to remove it promptly.
- When mounting the Display on the wall, prevent the mounting screws and power cable from contacting metal objects inside the wall. An electric shock may occur if they contact metal objects inside the wall.

### ■ When using the LCD Display

The Display is designed to operate on 110 – 240 V AC, 50/60 Hz.

**If problems or malfunction occur, stop using immediately.**

**If problems occur, unplug the power supply plug.**

- Smoke or an abnormal odour come out from the unit.
- No picture appears or no sound is heard, occasionally.
- Liquid such as water or foreign objects got inside the unit.
- The unit has deformed or broken parts.

**If you continue to use the unit in this condition, it could result in fire or electric shock.**

- Unplug the power supply plug from the wall outlet, and then contact the dealer for repairs.
- To cut off the power supply to this Display completely, you need to unplug the power supply plug from the wall outlet.
- Repairing the unit yourself is dangerous, and shall never be done.
- To enable to unplug the power supply plug immediately, use the wall outlet which you can reach easily.

**Do not touch the unit directly by hand when it is damaged.**

- Electric shock could occur.

**Do not stick any foreign objects into the Display.**

- Do not insert any metal or flammable objects into the ventilations holes or drop them onto the Display, as doing so can cause fire or electric shock.

**Do not remove the cover (cabinet) or modify it.**

- High voltages which can cause fire or electric shocks are present inside the Display. For any inspection, adjustment and repair work, please contact your local Panasonic dealer.

**Ensure that the mains plug is easily accessible.**

**The mains plug shall be connected to a mains socket outlet with a protective earthing connection.**

**Do not use any power supply cord other than that provided with this unit.**

- Doing so may cause short-circuit, generates heat, etc., which could cause electric shock or fire.

**Do not use the supplied power supply cord with any other devices.**

- Doing so may cause short-circuit, generates heat, etc., which could cause electric shock or fire.

**Clean the power supply plug regularly to prevent it becoming dusty.**

- If there is a build up of dust on the plug, the resultant humidity may cause short-circuit, which could cause electric shock or fire. Unplug the power supply plug from the wall outlet and wipe it with a dry cloth.

**Do not handle the power supply plug with wet hands.**

- Doing so may cause electric shocks.

**Securely insert the power supply plug (socket outlet side) and the power supply connector (main unit side) as far as it will go.**

- If the plug is not fully inserted, heat may be generated which could cause fire. If the plug is damaged or the wall socket is loose, they shall not be used.

**Do not do anything that may damage the power supply cord or the power supply plug.**

- Do not damage the cable, make any modifications to it, place heavy objects on top of it, heat it, place it near any hot objects, twist it, bend it excessively or pull it. To do so may cause fire and electric shock. If the power cable is damaged, have it repaired at your local Panasonic dealer.

**Do not touch the power supply cord or the plug directly by hand when they are damaged.**

- Doing so may cause electric shock or fire due to short-circuit.

**Keep the supplied AAA/R03/LR03 batteries, M4 screw and washer out of reach of children. If accidentally swallowed, it will be harmful to the body.**

- Please contact a doctor immediately in case you doubt that the child may have swallowed it.

**To prevent the spread of fire, keep candles or other open flames away from this product at all times.**



## CAUTION

**Do not place any objects on top of the Display.**

**Ventilation should not be impeded by covering the ventilation openings with items such as newspapers, table cloths and curtains.**

- Doing so may cause the Display to overheat, which can cause fire or damage to the Display.

For sufficient ventilation, see page 9.

**Do not place the display where it may be affected by salt or corrosive gas.**

- Doing so may cause the display to fall due to corrosion, and it may result in injury. Also, the unit may malfunction.

**The following number of people are required to carry or unpack this unit.**

98-inch model  86-inch model  75-inch model :

4 or more

65-inch model  55-inch model  49-inch model :

2 or more

- If this is not observed, the unit may drop, resulting in injury.

**When disconnecting the power supply cord, always pull on the plug (socket outlet side) / the connector (main unit side).**

- Pulling the cord may damage the cord, and it may cause electric shock or fire due to short-circuit.

**Be sure to disconnect all cables and overturn prevention accessories before moving the Display.**

- If the Display is moved while some of the cables are still connected, the cables may become damaged, and fire or electric shock could result.

**Disconnect the power supply plug from the wall socket as a safety precaution before carrying out any cleaning.**

- Electric shocks can result if this is not done.

**Do not step on, or hang from the display or the Pedestal.**

- They might tip over, or might be broken and it may result in injury. Pay special attention to the children.

**Do not reverse the polarity (+ and -) of the battery when inserting.**

- Mishandling the battery may cause its explosion or leakage, resulting in fire, injury or damage to surrounding properties.
- Insert the battery correctly as instructed. (see page 12)

**Do not use batteries with the outer cover peeling away or removed.**

- Mishandling the batteries may cause the batteries to short circuit, resulting in fire, injury or damage to surrounding properties.

**Remove the batteries from the remote control transmitter when not using for a long period of time.**

- The battery may leak, heat, ignite or burst, resulting in fire or damage to surrounding properties.

**Remove exhausted batteries from the remote control immediately.**

- Leaving the batteries unattended in it may cause battery leakage, heat or burst.

**Do not burn or breakup batteries.**

- Batteries must not be exposed to excessive heat such as sunshine, fire or the like.

**Do not turn the Display upside down.**

**Do not position the unit with its liquid crystal**

**panel facing upright.** ( 98-inch model  86-inch model

75-inch model  only)



# Precautions for use

## Cautions when installing

### Do not set up the Display outdoors.

- The Display is designed for indoor use.

### Install this unit at a location which can support the weight of the unit.

- Dropping or falling of the unit may cause injury.

### Environmental temperature to use this unit

- When using the unit where it is below 1 400 m (4 593 ft) above sea level: 0 °C to 40 °C (32 °F to 104 °F)
- When using the unit at high altitudes (1 400 m (4 593 ft) and higher and below 2 800 m (9 186 ft) above sea level): 0 °C to 35 °C (32 °F to 95 °F)

### Do not install the unit where it is 2 800 m (9 186 ft) and higher above sea level.

- Failure to do so may shorten the life of the internal parts and result in malfunctions.

### When installing the unit (65-inch model)

(55-inch model) (49-inch model) with its liquid crystal panel facing upright, ask your local Panasonic dealer.

### For 98/86/75-inch models, do not position the unit with its liquid crystal panel facing upright.

- There are conditions of mounting method, environmental temperature, connections and settings.

### We are not responsible for any product damage, etc. caused by failures in the installation environment even during the warranty period.

### Transport only in upright position!

- Transporting the unit with its liquid crystal panel facing upright or downward may cause damage to the internal circuitry.

### Do not grab the liquid crystal panel.

- Do not forcibly press the liquid crystal panel, or push it with a pointed object. Applying a strong force to the liquid crystal panel will cause unevenness of the screen display, resulting in malfunction.

### Do not install the product to a place where the product is exposed to direct sunlight.

- If the unit is exposed to direct sunlight even indoors, the temperature rise of the liquid crystal panel may cause malfunction.

### In the case of storage, store the unit in a dry room.

### Required space for ventilation

- Operation of this unit is guaranteed up to an ambient temperature of 40 °C (104 °F). When installing the unit in a case or chassis, be sure to provide adequate ventilation with a cooling fan or ventilation hole so that the surrounding temperature (inside the case or chassis) including the temperature of the front surface of the liquid crystal panel can be kept at 40 °C (104 °F) or less.

## About the screws used when using a wall hanging bracket that conforms to VESA standards

Inch model	Screw pitch for installation	Depth of screw hole	Screw (quantity)
98	800 mm × 500 mm	13 mm	M8 (4)
86	600 mm × 400 mm	13 mm	M8 (4)
75	600 mm × 400 mm	10 mm	M6 (4)
65	400 mm × 400 mm	11 mm	M6 (4)
55			
49			

## Note for connection

### Removing and inserting the power cord and connection cables

- When the unit has been installed on the wall, if the power cord and connection cables are difficult to remove and insert, make connections first before installation. Be careful not to allow the cables to be entangled. After installation is completed, insert the power plug to the outlet.

## When using

### Be careful of the movable structure of the power indicator and remote control sensor.

- As factory default, the power indicator and remote control sensor are stored in the main unit. For normal use, pull out the remote control sensor from the edge side of the main unit by operating the lever on the rear panel. Depending on the setup condition such as when using multi screen display of the multi display, store the remote control sensor in the main unit. (see page 21)

### Red, blue or green dots on the screen are a liquid crystal panel-specific phenomenon. This is not a malfunction.

- Although the liquid crystal display is manufactured with high-precision technology, always-lighting dots or non-lighting dots may appear on the screen. This is not a malfunction.

Inch model	Dot omission ratio*
98	0.00007% or less
86	0.00007% or less
75	0.00006% or less
65	0.00006% or less
55	0.00004% or less
49	0.00004% or less

\*: Calculated in sub-pixel units according to the ISO9241-307 standard.

### Depending on the temperature or humidity conditions, uneven brightness may be observed. This is not a malfunction.

- This unevenness will disappear while applying current continuously. If not, consult the distributor.

### If the Display is not going to be used for any prolonged length of time, unplug the power supply plug from the wall outlet.

If the power is instantaneously interrupted or stopped, or if the power voltage is instantaneously lowered, the Display may not operate normally.

- In this case, turn off the power of the Display and the connected devices once, and then turn on the power again.

**Picture noise may occur if you connect / disconnect the cables connected to the input terminals you are currently not watching, or if you turn the power of the video equipment on / off, but it is not a malfunction.**

## Notes on Using Wired LAN

**When setting up the Display at a place, where electric static occurs often, take a sufficient antistatic measure before start using.**

- When the Display is used at a location, where static electricity occurs often, such as on a carpet, a wired LAN or DIGITAL LINK communication is disconnected more often. In that case, remove static electricity and the noise source that may cause problems with an antistatic mat, and re-connect the wired LAN or DIGITAL LINK.
- In rare cases, the LAN connection is disabled due to static electricity or noise. In that case, turn off the power of the Display and the connected devices once and then re-turn on the power.

**The Display may not work properly due to strong radio wave from the broadcast station or the radio.**

- If there is any facility or equipment, which outputs strong radio wave, near the installation location, set up the Display at a location sufficiently far from the source of the radio wave. Or, wrap the LAN cable connected to the DIGITAL LINK / LAN terminal by using a piece of metal foil or a metal pipe, of which is grounded at both ends.

## Request Regarding Security

**When using this unit, take safety measures against the following incidents.**

- Personal information being leaked via this unit
- Unauthorized operation of this unit by a malicious third party
- Interfering or stopping of this unit by a malicious third party

**Take sufficient security measures.**

- Set a password for the LAN control and restrict the users who can log in.
- Make your password difficult to guess as much as possible.
- Change your password periodically.
- Panasonic Connect Co., Ltd. or its affiliate companies will never ask for your password directly. Do not divulge your password in case you receive such inquiries.
- The connecting network must be secured by a firewall, etc.
- When disposing the product, initialize the data before disposing.

## Cleaning and maintenance

**First, remove the mains plug from the mains socket.**

**Gently wipe the surface of the liquid crystal panel or cabinet by using a soft cloth to remove dirt.**

- To remove stubborn dirt or fingerprints on the surface of the liquid crystal panel, dampen a cloth with diluted neutral detergent (1 part detergent to 100 parts water), wring out the cloth firmly, and then wipe away the dirt. Finally, wipe away all the moisture with a dry cloth.
- If water droplets get inside the unit, operating problems may result.

### Note

- The surface of the liquid crystal panel is specially treated. Do not use a hard cloth or rub the surface too hard, otherwise this may cause scratches on the surface.

**Usage of a chemical cloth**

- Do not use a chemical cloth for the liquid crystal panel surface.
- Follow the instructions for the chemical cloth to use it for the cabinet.

**Avoid contact with volatile substances such as insect sprays, solvents and thinner.**

- This may cause damage to the cabinet or cause peeling of the paint. Furthermore, do not leave it in contact with a rubber or PVC substance for a long time.

## Disposal

**When disposing the product, ask your local authority or dealer about the correct methods of disposal.**

# Accessories

## Accessories Supply

Check that you have the accessories and items shown.

### Remote Control Transmitter × 1

- DPVF2713ZA/X1



### Batteries for the Remote Control Transmitter × 2 (AAA/R03/LR03 type)

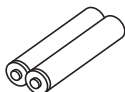

### Clamper × 3

- DPVF1056ZA

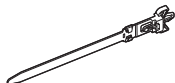

### USB memory cover × 1

98-inch model

86-inch model

75-inch model

65-inch model

55-inch model

- DPVF2281ZA/X1

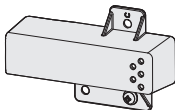

49-inch model

- DPVF2280ZA/X1

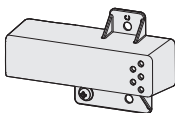

### SLOT adapter × 1

- DPVF2722YA/X1

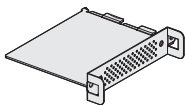

### Power supply cord

(Approx. 2 m)

- 1JP155AF1U
- 1JP155AF1W
- 2JP155AF1W
- 3JP155AF1W

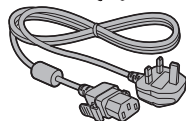
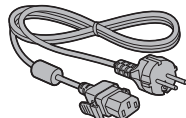
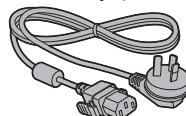
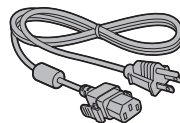

### Attention

- Store small parts in an appropriate manner, and keep them away from young children.
- The part numbers of accessories are subject to change without notice. (The actual part number may differ from the ones shown above.)
- In case you lost accessories, please purchase them from your dealer. (Available from the customer service)
- Dispose the packaging materials appropriately after taking out the items.

## Remote Control Batteries

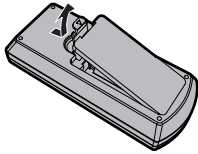

Open the battery cover.

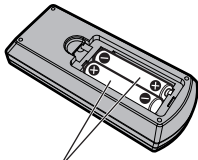

Insert batteries and close the battery cover.

(Insert starting from the  side.)

AAA/R03/LR03 type

### Note

- Incorrect installation of the batteries can cause battery leakage and corrosion that will damage the remote control.
- Disposal of batteries should be done in an environment-friendly manner.

### Take the following precautions.

1. Batteries shall always be replaced as a pair.
2. Do not combine a used battery with a new one.
3. Do not mix battery types (example; manganese dioxide battery and alkaline battery etc.).
4. Do not attempt to charge, disassemble or burn used batteries.
5. Do not burn or breakup batteries.  
Moreover, batteries must not be exposed to excessive heat such as sunshine, fire or the like.

## Attaching the USB Memory Cover

When using a USB memory device, the USB memory cover can be attached to protect the device.

Attach the USB memory cover using any of the following screw positions corresponding to the type of model.

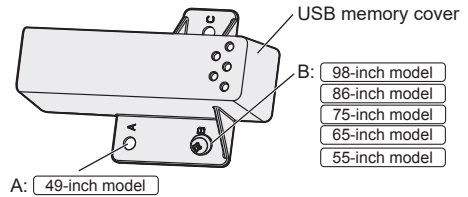

**1** Insert the USB memory device to the USB terminal on the bottom of the display.

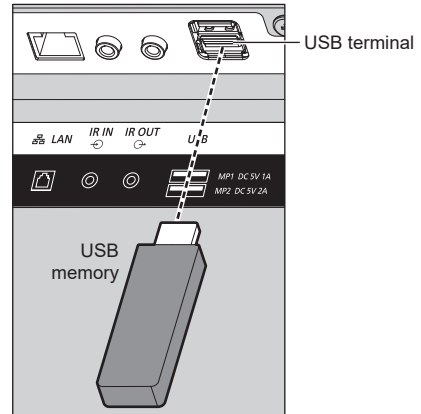

### Note

- Select the USB terminal to be used with [USB select].
- Depending on the USB terminal, the amount of electricity supplied to an external device differs.

**2** Attach the USB memory cover, aligning the M4 screw with the screw hole of the display unit.

### 3 Tighten the M4 screw to fix the USB memory cover.

A: 49-inch model

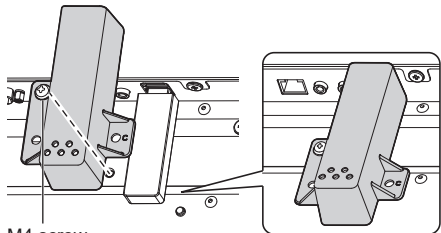

M4 screw

B: 98-inch model 86-inch model 75-inch model  
65-inch model 55-inch model

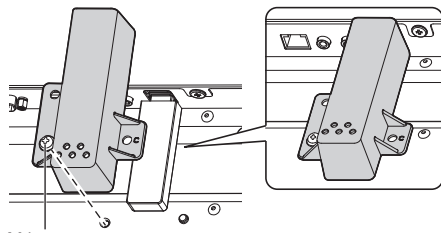

M4 screw

### Attaching the Function Board

When using a narrow-width function board, attach the supplied SLOT adaptor, and insert it to the slot.

#### Note

- Before attaching or removing the function board, be sure to turn off the power of the display and remove the power plug from the outlet.

When attaching a full-size function board, proceed to step 4.

### 1 Remove one screw from the side with the guide on the SLOT adaptor.

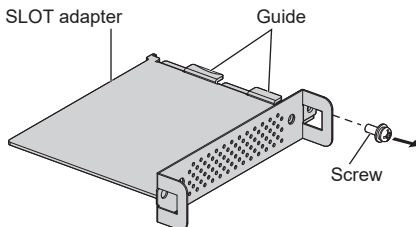

### 2 Fit the circuit board of the function board in the guides of the SLOT adaptor, and bring the circuit board into contact with the hook (one location) and the end faces (two locations) securely.

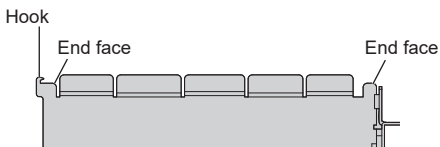
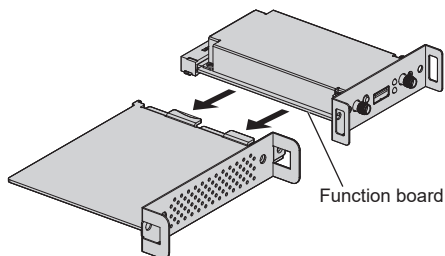

### 3 Using the screw removed in step 1, fix the function board to the SLOT adaptor.

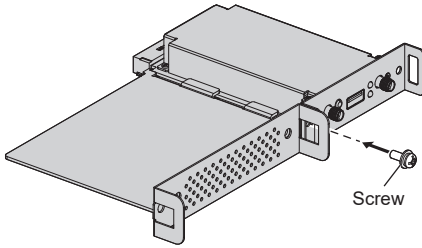

- Tightening torque guideline: 0.5 N·m or less

#### Note

- Firmly tighten the screw, and check that the hook of the SLOT adaptor fixes the circuit board.
- Check that the surface of the SLOT adaptor and the surface of the circuit board match with each other when the function board with the SLOT adaptor attached is viewed from the opposite side of the cover.

Make sure that this side is aligned.

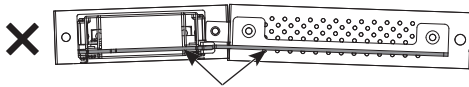
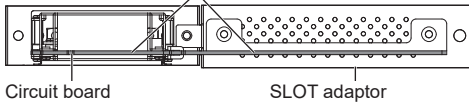

It cannot be attached unless this side is horizontally aligned.

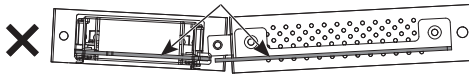

- If there is a lead wire within approx. 3 mm from the end face of the circuit board, the function board cannot be attached due to interference with the guide rail. Ensure that there is no lead wire in this range.

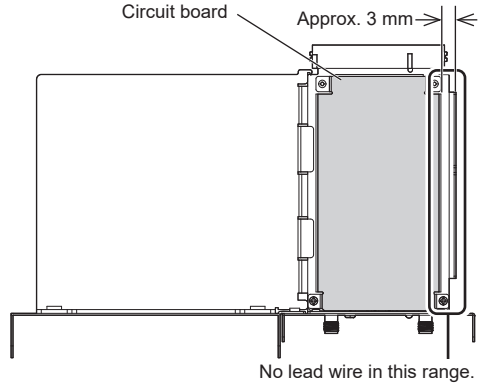

### 4 Remove the two screws from the main unit slot cover.

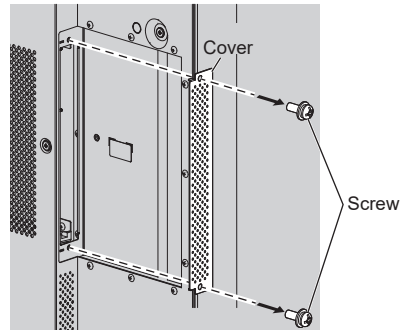

### 5 Insert the function board to the main unit slot, and fix it with the two screws removed in step 4.

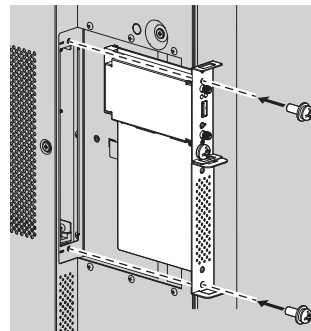

- Tightening torque guideline: 0.5 N·m or less

# Cautions when moving

The display has handles for carrying. Hold them when moving.

98-inch model 86-inch model

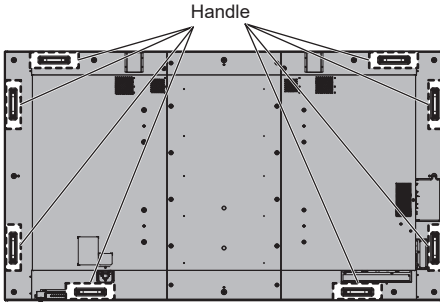

75-inch model

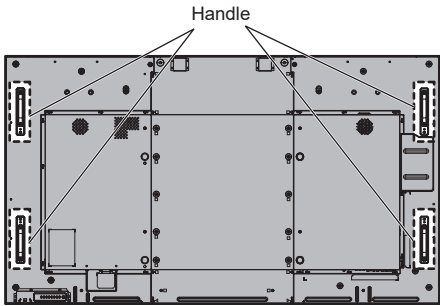

65-inch model

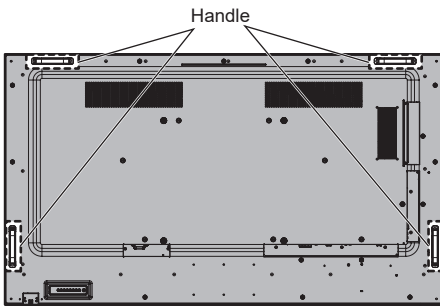

55-inch model 49-inch model

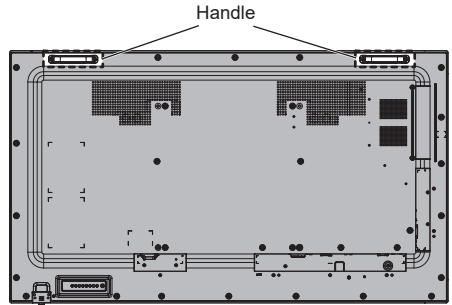

## Note

- Do not hold parts other than the handles.  
98-inch model 86-inch model 75-inch model
- The following number of people are required to carry this unit.

98-inch model 86-inch model 75-inch model :  
4 or more

65-inch model 55-inch model 49-inch model :  
2 or more

If this is not observed, the unit may drop, resulting in injury.

- When carrying the unit, keep the liquid crystal panel upright.  
Carrying the unit with the surface of the liquid crystal panel facing up or down may cause deformation of the panel, or internal damage.
- Do not hold the upper, lower, right and left frames or the corners of the unit. Do not hold the front surface of the liquid crystal panel. Also, do not hit such parts.  
Doing so may damage the liquid crystal panel.  
Also, the panel may crack, resulting in injury.

# Eyebolt

98-inch model

86-inch model

75-inch model

The display has holes for attaching eyebolts (M10). When installing, use them to suspend the display.

Use the eyebolt only for temporary suspension or movement for installation. This cannot be used for permanent hanging installation.

Eyebolt (commercially available) mounting positions

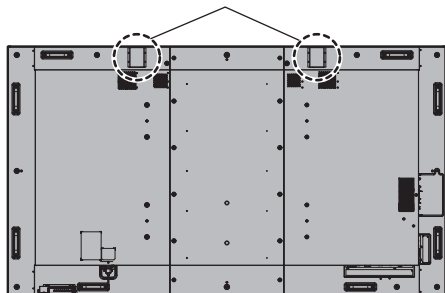

- 1 When attaching the eyebolt, remove the eyebolt cap from the eyebolt mounting position (two locations), and leave the flat washer (black) as it is.**

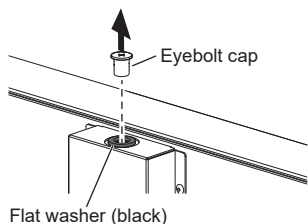

- 2 Attach the eyebolt with the flat washer (black) left as it is.**

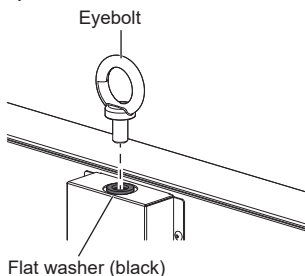

- 3 After removing the eyebolt, tighten the eyebolt cap with the flat washer (black) left as it is.**

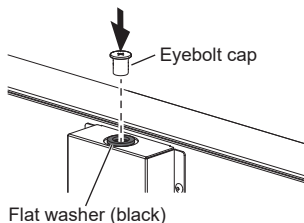

## Note

- Installation should be performed by an installation professional.
- Do not suspend using only 1 eyebolt.
- Use commercially sold M10 eyebolts with a shank length of 12 mm to 40 mm that satisfies the load condition of product quality.
- Use ISO 3266 standard eyebolts. Also use ISO standard members (wire, etc.) for hanging.
- The hanging angle should be 60° or more.
- After installation, remove the eyebolts, and close the holes using the eyebolt caps removed when attaching the eyebolts.

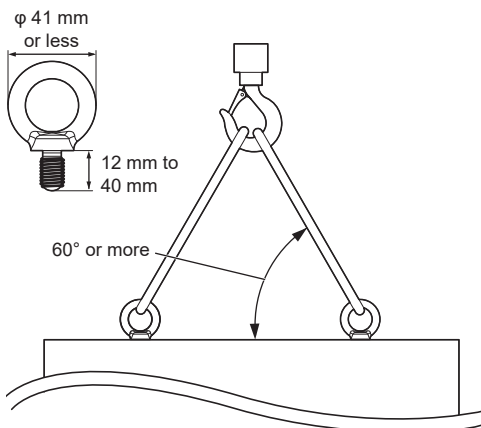



# Connections

## AC cord connection and fixing / Cable fixing

Back of the unit

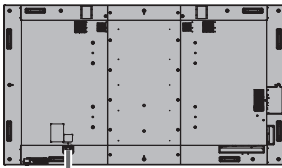

### AC cord fixing

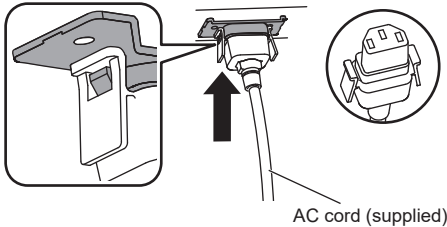

### Plug the connector into the display unit.

Plug the connector until it clicks.

#### Note

- Make sure that the connector is locked on both the left and right sides.

### Unplug the AC cord

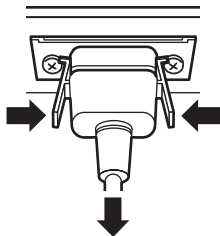

Unplug the connector pressing the two knobs.

#### Note

- Do not use an AC cord of which the knobs are damaged. If it is used with the knobs damaged, a bad connection may result between the AC cord connector and the AC IN terminal. For the repair of the AC cord, consult the dealer where you purchased the product.
- When disconnecting the AC cord, be absolutely sure to disconnect the AC cord plug at the socket outlet first.
- The supplied AC cord is for this unit exclusive use. Do not use this for other purposes.

## Cable fixing

### Note

- 3 clampers are supplied with this unit. Fix the cables at 3 locations using the holes for clampers as shown below.
- Before turning the power on, stop the holes (3 locations) with the clampers. Otherwise, foreign objects may enter the holes, resulting in a fire.
  - If you need more clampers, purchase them from your dealer. (Available from the customer service)

98-inch model

Holes for attaching the clampers

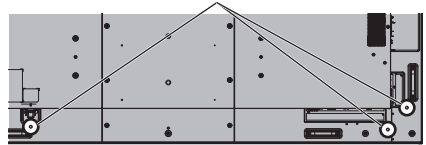

86-inch model

Holes for attaching the clampers

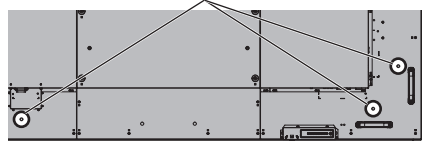

75-inch model

Holes for attaching the clampers

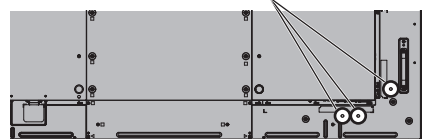

65-inch model

Holes for attaching the clampers

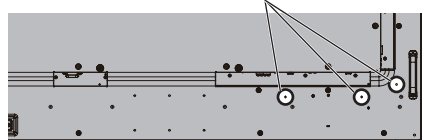

55-inch model

Holes for attaching the clampers

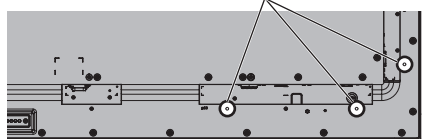

49-inch model

Holes for attaching the clampers

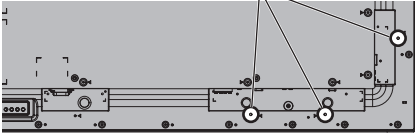

## 1. Attach the clammer

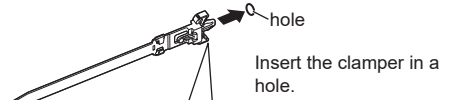

To remove from the unit:

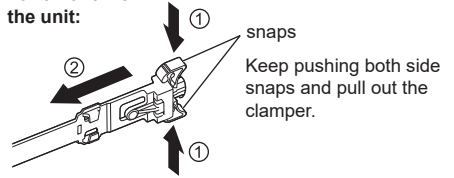

## 2. Bundle the cables

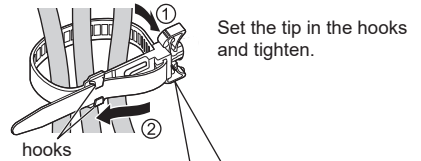

To loosen:

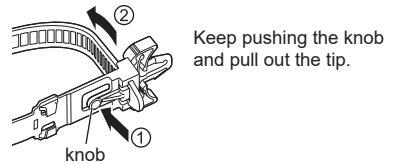

## Video equipment connection

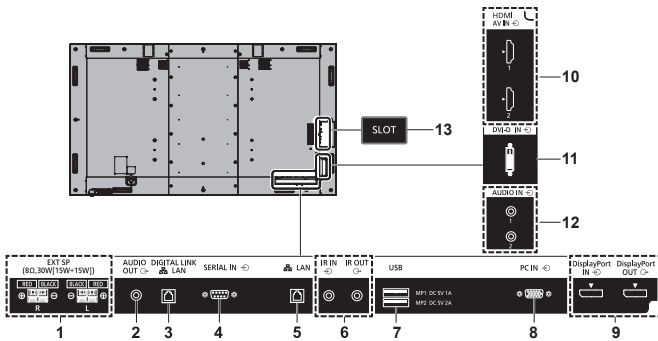

- |                              |   |
|------------------------------|---|
| <b>1 EXT SP:</b>             | <b>Speaker Terminal</b><br>Connect to external speaker.   |
| <b>2 AUDIO OUT:</b>          | <b>Analogue Audio Output Terminal</b><br>Connect to audio equipment with analogue audio input terminal.   |
| <b>3 DIGITAL LINK / LAN:</b> | <b>DIGITAL LINK / LAN Terminal</b><br>Control the Display by connecting to Network. Alternatively, connect to a device that sends video and audio signals via the DIGITAL LINK terminal.  |
| <b>4 SERIAL IN:</b>          | <b>SERIAL Input Terminal</b><br>Control the Display by connecting to PC.  |
| <b>5 LAN:</b>                | <b>LAN Terminal</b><br>Control the Display by connecting to Network.  |
| <b>6 IR IN, IR OUT:</b>      | <b>Infrared Signal Input / Output Terminal</b><br>Use this when operating more than one display with one remote control.  |
| <b>7 USB:</b>                | <b>USB Terminal (2 systems)</b><br>Connect the USB memory to use "USB media player" or "Memory viewer". Also, this can be used to supply power of up to 5V/1A (front side terminal) or 5V/2A (far side terminal) to an external device when the picture is displayed. |
| <b>8 PC IN:</b>              | <b>PC Input Terminal</b><br>Connect to video terminal of PC, video equipment with "YPbPr / YCbCr" or "RGB" output.  |

- |   |   |
|---|---|
| <b>9 DisplayPort IN, DisplayPort OUT:</b> | <b>DisplayPort Input / Output Terminal (Supports 4K picture)</b><br>Connect to PC or video equipment with DisplayPort terminal. |
| <b>10 AV IN (HDMI 1, HDMI 2):</b>         | <b>HDMI Input Terminal (2 systems)</b><br>Connect to video equipment with HDMI output.  |
| <b>11 DVI-D IN:</b>                       | <b>DVI-D Input Terminal</b><br>Connect to video equipment with DVI-D output.  |
| <b>12 AUDIO IN 1, AUDIO IN 2:</b>         | <b>Analogue Audio Input Terminal (2 systems)</b>  |
| <b>13 SLOT:</b>                           | <b>Expansion slot</b><br>(see page 13)  |

**Note**

- For the compatible function board, consult the dealer where you purchased the product.

## Before connecting

- Before connecting cables, carefully read the operating instructions for the external device to be connected.
- Turn off the power of all devices before connecting cables.
- Take note of the following points before connecting the cables. Failure to do so may result in malfunctions.
  - When connecting a cable to the unit or a device connected to the unit itself, touch any nearby metallic objects to eliminate static electricity from your body before performing work.
  - Do not use unnecessarily long cables to connect a device to the unit or to the unit body. The longer the cable, the more susceptible to noise it becomes. Since using a cable while it is wound makes it act like an antenna, it is more susceptible to noise.
  - When connecting cables, insert them straight into the connecting terminal of the connecting device so that the ground is connected first.
- Acquire any cable necessary to connect the external device to the system that is neither supplied with the device nor available as an option.
- If the outer shape of the plug of a connection cable is large, it may come in contact with the periphery such as a back cover or the plug of an adjacent connection cable. Use a connection cable with the suitable plug size for the terminal alignment.
- When connecting the LAN cable with plug cover, be aware that the cover may come in contact with the back cover and it may be difficult to disconnect.
- If video signals from video equipment contain too much jitter, the images on the screen may wobble. In this case, a time base corrector (TBC) must be connected.
- When the sync signals output from PC or video equipment are disturbed, for example, when changing settings of video output, the colour of the video may be disturbed temporarily.
- The unit accepts YPbPr/YCbCr signals (PC IN), analogue RGB signals (PC IN) and digital signals.
- Some PC models are not compatible with the unit.
- Use cable compensator when you connect devices to the unit using long cables. Otherwise the image may not be displayed properly.
- The DIGITAL LINK / LAN terminal and the LAN terminal are connected inside this unit. When using both the DIGITAL LINK / LAN terminal and the LAN terminal, configure the system in such a way that they are not connected to the same network directly or via peripheral devices such as hub and twist pair cable transmitter.

# Identifying Controls

## Display

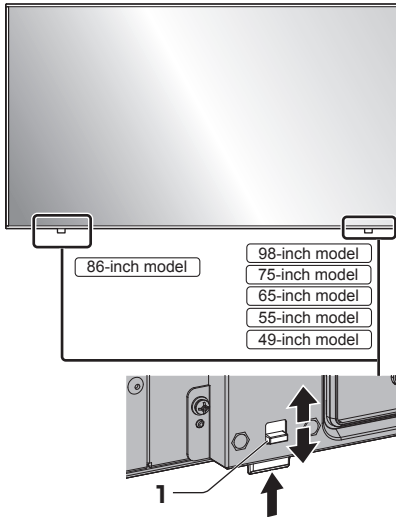

- Slide the lever on the rear panel to eject the power indicator and remote control sensor.

To store them, slide the same lever, or directly push in the bottom surface of the remote control sensor.

### Note

- For normal use, pull out the power indicator and remote control sensor from the edge side of the main unit by operating the lever on the rear panel. Depending on the setup condition such as when using multi screen display of the multi display, store them in the main unit.

## 1 Power Indicator / Remote control sensor

The Power Indicator will light.

**When the power of the unit is ON (Main Power On / Off button: ON)**

- Picture is displayed: green
- When the unit enters the standby mode using the following functions: orange (red / green)
  - Standby state with the “Quick start” function
  - Standby state with the “Power management” function
  - Standby state with [HDMI-CEC control] set to [Enable] and at least one [Link function] set to other than [Disable]
  - Standby state with [Network control] set to [On]
  - Standby state with the “SLOT standby” function
  - Standby state during schedule play mode
- Standby state in conditions other than the above: red

**When the power of the unit is OFF (Main Power On / Off button: OFF): No light**

### Note

- Even if the unit is turned off with the power indicator off, some of the circuits are in power-on status.
- When the power indicator is orange, power consumption during standby is generally larger than that of when the power indicator is red.

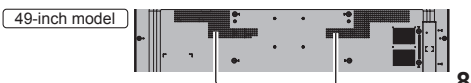
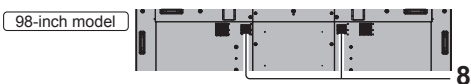
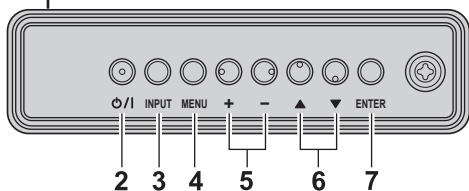
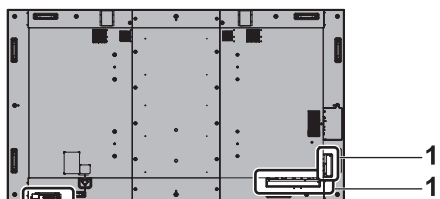

**1 External input / output terminal**

Connects to video equipment, PC, etc. (see page 19)

**2 <Main Power On / Off button> (⏻/⏿)**

Turns the power On / Off.

**3 <INPUT (Unit)>**

Selects the connected device.

**4 <MENU (Unit)>**

Displays the menu screen.

**5 <+ (Unit)> / <- (Unit)>**

Adjusts the volume.

On the main screen, switches settings or adjusts settings level.

**6 <▲ (Unit)> / <▼ (Unit)>**

Selects the setting item on menu screen.

**7 <ENTER (Unit)>**

Configures the item on menu screen.

Switches aspect mode.

**8 Built-in speakers**

Sound is output backward.

**Note**

- To output sound from the built-in speakers of the unit, be sure to set [Sound] - [Output select] to [INTERNAL SPEAKERS].

## Remote Control Transmitter

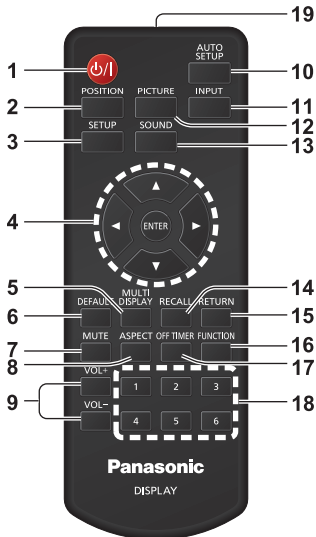

### 1 Standby (ON/OFF) button (⏻/⏻)

- Turns the power on or off when the unit is turned on at the <Main Power On / Off button>. (see page 25)

### 2 POSITION

### 3 SETUP

### 4 ENTER / Cursor buttons (▲▼◀▶)

- Used to operate the menu screens.

### 5 MULTI DISPLAY

- Switches between on and off of the multi display mode (multi input display, multi screen display).

### 6 DEFAULT

- Resets the settings of picture, sound, etc., to defaults.

### 7 MUTE

- Sound mute on / off.

### 8 ASPECT

- Adjusts the aspect.

### 9 VOL + / VOL -

- Adjusts sound volume level.

### 10 AUTO SETUP

- Automatically adjusts the position/size of the screen.

### 11 INPUT

- Switches input to display on the screen.

### 12 PICTURE

### 13 SOUND

### 14 RECALL

- Displays the current setting status of Input mode, Aspect mode, etc.

### 15 RETURN

- Used to return to the previous menu.

### 16 FUNCTION

- Displays [Function button guide].

### 17 OFF TIMER

- Switches to stand-by after a fixed period.

### 18 Numeric buttons (1 - 6)

- Used as shortcut buttons by assigning frequently used operations.

### 19 Signal emission

#### Note

- In this manual, buttons of the remote control and the unit are indicated as < >.

(Example: <INPUT>.)

The operation is mainly explained indicating the remote control buttons but you can also operate with the buttons on the unit when there are the same buttons.

- In the case of the Model No. DPVF1615ZA remote control, the <MULTI DISPLAY> button for item 5 is replaced with the <ZOOM> button.

# Basic Controls

Main Power On / Off button (⏻/⏻)

(Back of the unit)

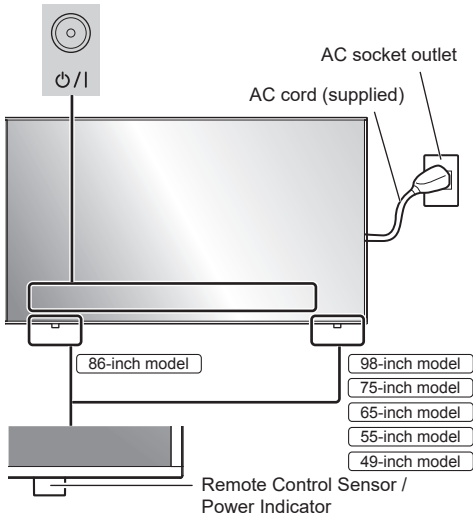

Operate pointing the remote control directly at the unit's Remote Control Sensor.

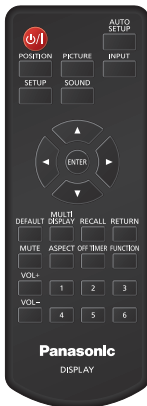

## Note

- For normal use, pull out the remote control sensor from the edge side of the main unit by operating the lever on the rear panel. (see page 21)
- Do not put an obstacle between the remote control sensor of the main unit and the remote control.
- Operate the remote control in front of the remote control sensor or from the area where the sensor can be seen.

- When directly aiming the remote control at the remote control sensor of the main unit, the distance from the front of remote control sensor should be approx. 7 m or less. Depending on the angle, the operation distance may be shorter.
- Do not subject the remote control sensor of the main unit to the direct sunlight or strong fluorescent light.

## 1 Connect the AC cord plug to the Display.

(see page 17)

## 2 Connect the plug to the socket outlet.

### Note

- Main plug types vary between countries. The power plug shown at left may, therefore, not be the type fitted to your set.
- When disconnecting the AC cord, be absolutely sure to disconnect the AC cord plug at the socket outlet first.
- The settings may not be saved if the power plug is disconnected immediately after changing settings with on-screen menu. Disconnect the power plug after a enough period of time. Or, disconnect the power plug after turning the power off with the remote control, RS-232C control or LAN control.

## 3 Press the <Main Power On / Off button> (⏻/⏻) on the unit to turn the power of the unit on.

- Power Indicator: Green (Picture is displayed.)
- When the power of the unit is on, the power indicator lights up and remote control operation is possible.
- When the power indicator is lit, it is not necessary to press the <Main Power On / Off button> (⏻/⏻) on the unit. Operate the remote control so that the power indicator turns green (picture is displayed).



## ■ To turn the power ON/OFF with the remote control

### To turn the power on

- When the power of the unit is on (Power Indicator - red or orange), press the <Standby (ON/OFF) button> (⏻/⏷), then the picture will be displayed.
- Power Indicator: Green (Picture is displayed.)

### To turn the power off

- When the power of the unit is on (Power Indicator - green), press the <Standby (ON/OFF) button> (⏻/⏷), then the power will be turned off.
- Power Indicator: Red (standby)

#### Note

- During operation of the “Power management” function, the power indicator turns orange in the power off state.
- After the power plug is disconnected, the power indicator may remain lit for a while. This is not a malfunction.
- Press the <Main Power On / Off button> (⏻/⏷) on the unit to turn the unit off, when the power of the unit is turned on or in standby mode.

## ■ When the Unit is turned on for the first time

Following screen will be displayed.

### 1 Select the language with ▲ ▼ and press <ENTER>.



### 2 For vertical installation, select [Portrait] with ▲ ▼ and press <ENTER>.

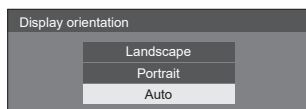

#### Note

- Once the items are set, the screens won't be displayed when switching on the unit next time. Each item can be reset in the following menus.

[OSD language]

[Display orientation]

## ■ Power ON message

The following message may be displayed when turning the unit power ON:

### No activity power off Precautions

'No activity power off' is enabled.

When [No activity power off] in the [Setup] menu is set to [Enable], a warning message is displayed every time the power is turned ON.

### “Power management” information

Last turn off due to 'Power management'.

When “Power management” is functioned, an information message is displayed every time the power is turned ON.

### Display reverse installation information

The display is upside-down.

When it is judged that the display is reversely installed, an information message is displayed when the power is turned ON.

These message displays can be set with the following menu:

- [Power on settings] menu  
Information(No activity power off)  
Information(Power management)  
Information(Display upside-down)

# Specifications

## Model No.

98-inch model : TH-98SQ1W

86-inch model : TH-86SQ1W

75-inch model : TH-75SQ1W

65-inch model : TH-65SQ1W

55-inch model : TH-55SQ1W

49-inch model : TH-49SQ1W

## Power Consumption

98-inch model

685 W

86-inch model

480 W

75-inch model

385 W

65-inch model

320 W

55-inch model

300 W

49-inch model

285 W

### Power off condition

0.3 W

### Stand-by condition

0.5 W (Quick start: Off)

## LCD Display panel

98-inch model

98-inch IPS panel (Direct LED backlight),  
16:9 aspect ratio

86-inch model

86-inch IPS panel (Edge LED backlight),  
16:9 aspect ratio

75-inch model

75-inch IPS panel (Edge LED backlight),  
16:9 aspect ratio

65-inch model

65-inch IPS panel (Edge LED backlight),  
16:9 aspect ratio

55-inch model

55-inch IPS panel (Edge LED backlight),  
16:9 aspect ratio

49-inch model

49-inch IPS panel (Edge LED backlight),  
16:9 aspect ratio

## Screen size

98-inch model

2 158.8 mm (W) × 1 214.3 mm (H) × 2 476.9 mm  
(diagonal) / 84.99" (W) × 47.80" (H) × 97.51"  
(diagonal)

86-inch model

1 895.0 mm (W) × 1 065.9 mm (H) × 2 174.2 mm  
(diagonal) / 74.60" (W) × 41.96" (H) × 85.60"  
(diagonal)

75-inch model

1 649.6 mm (W) × 927.9 mm (H) × 1 892.7 mm  
(diagonal) / 64.94" (W) × 36.53" (H) × 74.51"  
(diagonal)

65-inch model

1 428.4 mm (W) × 803.5 mm (H) × 1 638.9 mm  
(diagonal) / 56.23" (W) × 31.63" (H) × 64.52"  
(diagonal)

55-inch model

1 209.6 mm (W) × 680.4 mm (H) × 1 387.8 mm  
(diagonal) / 47.62" (W) × 26.78" (H) × 54.63"  
(diagonal)

49-inch model

1 073.8 mm (W) × 604.0 mm (H) × 1 232.0 mm  
(diagonal) / 42.27" (W) × 23.77" (H) × 48.50"  
(diagonal)

## No. of pixels

8 294 400

(3 840 (Horizontal) × 2 160 (Vertical))

## Dimensions (W × H × D)

98-inch model

2 194 mm × 1 249 mm × 90 mm  
(excluding handles: 81 mm) /  
86.35" × 49.15" × 3.54"  
(excluding handles: 3.17")

86-inch model

1 928 mm × 1 099 mm × 86 mm  
(excluding handles: 76 mm) /  
75.91" × 43.27" × 3.39"  
(excluding handles: 2.99")

75-inch model

1 681 mm × 959 mm × 73 mm (excluding handles:  
66 mm) / 66.15" × 37.75" × 2.87" (excluding handles:  
2.58")

65-inch model

1 458 mm × 836 mm × 77 mm  
(excluding handles: 69 mm) /  
57.40" × 32.90" × 3.02"  
(excluding handles: 2.73")

55-inch model

1 240 mm × 714 mm × 74 mm  
(excluding handles: 66 mm) /  
48.82" × 28.09" × 2.88"  
(excluding handles: 2.58")

#### 49-inch model

1 105 mm × 637 mm × 74 mm  
(excluding handles: 66 mm) /  
43.48" × 25.08" × 2.88"  
(excluding handles: 2.58")

### Mass

#### 98-inch model

Approx. 90.0 kg / 198.5 lbs net

#### 86-inch model

Approx. 66.0 kg / 145.5 lbs net

#### 75-inch model

Approx. 56.0 kg / 123.5 lbs net

#### 65-inch model

Approx. 36.0 kg / 79.4 lbs net

#### 55-inch model

Approx. 25.5 kg / 56.3 lbs net

#### 49-inch model

Approx. 21.0 kg / 46.3 lbs net

### Power source

110 – 240 V ~ (110 – 240 V alternating current),  
50/60 Hz

### Operating condition

#### Temperature

0 °C – 40 °C (32 °F – 104 °F)\*1,3

#### Humidity

20 % – 80 % (no condensation)

### Operating Time

24 hours/day

### Supply power for SLOT

3.3 V/max 1.1 A, 12 V/max 5.5 A

### Connection terminals

#### HDMI 1

#### HDMI 2

TYPE A Connector\*2 × 2 (Supports 4K)

Compatible with HDCP 2.2

Audio signal:

Linear PCM (sampling frequencies: 48 kHz,  
44.1 kHz, 32 kHz)

#### DisplayPort IN

DisplayPort Terminal × 1

Compatible with HDCP 2.2

Audio signal:

Linear PCM (sampling frequencies: 48 kHz,  
44.1 kHz, 32 kHz)

#### DisplayPort OUT

DisplayPort Terminal × 1

Compatible with HDCP 1.4

#### DVI-D IN

DVI-D 24 Pin × 1:

Compliance with DVI Revision 1.0

Compatible with HDCP 1.1

#### PC IN

Mini D-sub 15 Pin (Compatible with DDC2B) × 1

Y/G:

1.0 Vp-p (75 Ω) (with sync signal)

0.7 Vp-p (75 Ω) (without sync signal)

Pb/Cb/B:

0.7 Vp-p (75 Ω) (without sync signal)

Pr/Cr/R:

0.7 Vp-p (75 Ω) (without sync signal)

HD/VD:

TTL (high impedance)

#### AUDIO IN 1

Stereo mini jack (M3) × 1, 0.5 Vrms

#### AUDIO IN 2

Stereo mini jack (M3) × 1, 0.5 Vrms

#### AUDIO OUT

Stereo mini jack (M3) × 1, 0.5 Vrms

Output: Variable (-∞ – 0 dB)

(1 kHz 0 dB input, 10 kΩ load)

#### SERIAL IN

External Control Terminal

D-sub 9 Pin × 1:

RS-232C compatible

#### LAN

RJ45 × 1:

For network connection, compatible with PLink

Communication method:

RJ45, 10BASE-T / 100BASE-TX

#### DIGITAL LINK / LAN

RJ45 × 1:

For network connection, DIGITAL LINK  
connection, compatible with PLink

Communication method:

RJ45, 100BASE-TX, long reach mode is  
supported

Compatible with HDCP 2.2

## IR IN

Stereo mini jack (M3) × 1

---

## IR OUT

Stereo mini jack (M3) × 1

---

## USB

USB connector × 2, TYPE A  
DC 5V/1A (front side terminal),  
DC 5V/2A (far side terminal)

---

## EXT SP

8 Ω, 30 W [15 W + 15 W] (10 % THD)

## Sound

---

### Speakers

98-inch model 86-inch model 75-inch model

15 mm × 25 mm × 1 / φ 70 mm × 1 × 2 pieces

65-inch model 55-inch model 49-inch model

φ 30 mm × 2 × 2 pieces

### Audio Output

20 W [10 W + 10 W] (10 % THD)

## Remote Control Transmitter

---

### Power source

DC 3 V (battery (AAA/R03/LR03 type) × 2)

### Operating range

Approx. 7 m (22.9 ft)

(when operated directly in front of remote control sensor)

### Mass

Approx. 63 g / 2.22 oz (including batteries)

### Dimensions (W × H × D)

48 mm × 134 mm × 20 mm / 1.89" × 5.28" × 0.76"

---

\*1: Environmental temperature to use this unit at high altitudes (1 400 m (4 593 ft) and higher and below 2 800 m (9 186 ft) above sea level): 0 °C to 35 °C (32 °F to 95 °F)

\*2: VIERA LINK is not supported.

\*3: Temperature of operating condition when using the unit with its liquid crystal panel facing upright is shown below.

65-inch model:

0 °C – 35 °C (32 °F – 95 °F)

55-inch model 49-inch model:

0 °C – 30 °C (32 °F – 86 °F)

When installing the unit with its liquid crystal panel facing upright, ask your local Panasonic dealer. There are conditions of mounting method, environmental temperature, connections and settings.

## Note

- Design and specifications are subject to change without notice. Mass and dimensions shown are approximate.

# Software License

---

This product incorporates the following software:

- (1) the software developed independently by or for Panasonic Connect Co., Ltd.,
- (2) the software owned by third party and licensed to Panasonic Connect Co., Ltd.,
- (3) the software licensed under the GNU General Public License, Version 2.0 (GPL V2.0),
- (4) the software licensed under the GNU LESSER General Public License, Version 2.1 (LGPL V2.1), and/or
- (5) open source software other than the software licensed under the GPL V2.0 and/or LGPL V2.1.

The software categorized as (3) - (5) are distributed in the hope that it will be useful, but WITHOUT ANY WARRANTY, without even the implied warranty of MERCHANTABILITY or FITNESS FOR A PARTICULAR PURPOSE. For details, see the license conditions displayed by selecting [Software licenses], following the specified operation from the [Settings] menu of this product.

At least three (3) years from delivery of this product, Panasonic Connect Co., Ltd. will give to any third party who contacts us at the contact information provided below, for a charge no more than our cost of physically performing source code distribution, a complete machine-readable copy of the corresponding source code covered under GPL V2.0, LGPL V2.1 or the other licenses with the obligation to do so, as well as the respective copyright notice thereof.

Contact Information:

oss-cd-request@gg.jp.panasonic.com

## Notice about AVC/VC-1/MPEG-4

This product is licensed under the AVC Patent Portfolio License, VC-1 Patent Portfolio License and MPEG-4 Visual Patent Portfolio License for the personal use of a consumer or other uses in which it does not receive remuneration to (i) encode video in compliance with the AVC Standard, VC-1 Standard and MPEG-4 Visual Standard ("AVC/VC-1/MPEG-4 Video") and/or (ii) decode AVC/VC-1/MPEG-4 Video that was encoded by a consumer engaged in a personal activity and/or was obtained from a video provider licensed to provide AVC/VC-1/MPEG-4 Video. No license is granted or shall be implied for any other use. Additional information may be obtained from MPEG LA, LLC. See <http://www.mpegla.com>.

**PANASONIC PROFESSIONAL DISPLAY  
 Limited Warranty**

Models or Parts	Part Warranty	Labor Warranty
All Professional Display Model	3 Years	3 Years
<b>Exceptions</b>		
All Panasonic accessories: e.g. mounting kit, input signal module, cables, remote control, filter, batteries.	1 Year	1 Year

Panasonic Connect North America (referred to as “the Panasonic”) will repair the Professional Video product (the “Product”) and its accessories as defined in the attached table, with new or refurbished parts, free of charge in the continental USA, during the applicable warranty coverage period from the original date of purchase in the event of a defect in materials or workmanship as follows: On-Site, carry-in, or mail-in service within the **continental USA** may be obtained during the warranty period by contacting Panasonic’s Technical Support Center at the following toll free number **855-772-8324** or via

e-mail: [ProDisplaySupport@us.panasonic.com](mailto:ProDisplaySupport@us.panasonic.com). In case of mail-in service the customer is responsible for the cost of delivering of the Product to Panasonic’s facility, while Panasonic will pay for the return transportation of the repaired Product to the customer. For out of warranty Product units submitted for repairs or for in warranty units submitted by customers outside of the continental USA, shipping arrangements and cost (both ways) are the customer’s responsibility. Panasonic will also not be responsible for any costs associated with determining the source of system problems or for removing and installing the faulty Product.

This warranty is extended only to the original purchaser and is nontransferable. A purchase receipt or other proof of date of original purchase will be required before warranty service is rendered. Whenever the date of original purchase cannot be satisfactorily determined, the date of manufacture of the unit will be deemed to be the effective date of the warranty. Panasonic reserves the right to audit and reject any warranty claim that cannot be substantiated. This warranty only covers failures due to defects in materials or workmanship which occur during normal use of the Product.

The warranty **DOES NOT** cover damage to the display and its components which occur in shipping; failures which are caused by products not supplied by Panasonic; failures which result from accident, misuse, abuse, neglect, mishandling, misapplication, alteration, modification, faulty installation, setup adjustments, improper antenna, inadequate signal pickup, maladjustment of user controls, improper operation, power line surge, improper voltage supply, lightning damage, smoke or chemical vapors contamination, air conditioning, humidity control or other environmental conditions; failure to maintain the product in accordance with the applicable Operating Instructions; service by anyone other than an authorized repair facility; damage that is attributable to acts of violence, war, acts of God or force majeure.

The warranty does not cover damage which occurs to the display or its components caused by excessive continual usage which goes beyond the operational time described in the Operating Instructions. The warranty does not cover units of which the model and serial number label has been defaced, modified, tampered with or removed. The warranty does not cover consumable parts.

**LIMITS AND EXCLUSIONS**

PANASONIC SHALL NOT BE LIABLE FOR ANY INDIRECT, INCIDENTAL, CONSEQUENTIAL, PUNITIVE OR SPECIAL DAMAGES, INCLUDING, BUT NOT LIMITED TO, LOSS OF DATA, LOSS OF PROFIT, LOSS OF REVENUE, OR LOSS OF BUSINESS OR GOODWILL, SUFFERED BY ANY PERSON, AND RESULTING FROM THE USE OF THIS PANASONIC PROFESSIONAL DISPLAY PRODUCT, OR ARISING OUT OF ANY BREACH OF THIS WARRANTY. ALL EXPRESS WARRANTIES SPECIFIED ABOVE ARE IN LIEU OF ALL OTHER WARRANTIES, EXPRESS, IMPLIED OR STATUTORY, INCLUDING BUT NOT LIMITED TO, THE IMPLIED WARRANTIES OF MERCHANTABILITY AND FITNESS FOR A PARTICULAR PURPOSE. Some states do not allow the exclusion or limitation of incidental or consequential damages, or limitations on how long an implied warranty lasts, so the above limitations or exclusions may not apply to you.

If you have a problem with this product that is not handled to your satisfaction, then write the Consumer Affairs Department at the Panasonic’s address indicated above.

**Panasonic Canada Inc.**  
5770 Ambler Drive, Mississauga, Ontario L4W 2T3  
**LIMITED WARRANTY STATEMENT**

Panasonic Canada Inc. (also known as PCI) warrants this product to be free of defects in material and workmanship under normal use during the applicable warranty coverage period described below. PCI agrees to repair, or at its option, exchange any part that becomes defective. However, the product must be purchased and serviced in Canada. The product or part that shows evidence of defect must be delivered prepaid or carried in to an authorized Panasonic Broadcast Service Center. This warranty does not cover shipping costs.

The warranty coverage period is one year for both parts and labour beginning with the date of original end user purchase, subject to the exceptions as stated below. Repaired or replacement parts supplied during the warranty coverage period carry the unexpired portion of the original warranty coverage period. Proof of product purchase is a condition of warranty service. The owner must produce the product purchase receipt or other satisfactory evidence of date of original purchase.

This warranty does not apply to external appearance items, such as handles, knobs, switches, buttons, etc. It also does not apply to accessories or parts of the product installed, altered, repaired or replaced by any party. In the event of PCI, effects the reliability of or detracts from the performance of the product.

For products requiring routine preventive maintenance, that maintenance must be performed in order to maintain warranty coverage.

Serial numbers that have been altered, defaced or removed void this warranty. This warranty does not cover replacements or repairs necessitated by loss or damage resulting from any cause beyond the control of PCI.

Marking or related images (sometimes called "burn-in") resulting from the display of fixed images on video display products are not defects and are not covered under this warranty.

**THIS EXPRESS, LIMITED WARRANTY IS IN LIEU OF ALL OTHER WARRANTIES, EXPRESS OR IMPLIED, INCLUDING ANY IMPLIED WARRANTIES OF MERCHANTABILITY AND FITNESS FOR A PARTICULAR PURPOSE. IN NO EVENT WILL PANASONIC CANADA INC. BE LIABLE FOR ANY SPECIAL, INDIRECT OR CONSEQUENTIAL DAMAGES.**

In certain instances, some jurisdictions do not allow the exclusion or limitation of incidental or consequential damages, or the exclusion of implied warranties, so the above limitations and exclusions may not be applicable.

**WARRANTY COVERAGE PERIOD EXCEPTIONS**

Item	Parts	Labour
Video Tape	30 days—Replacement only (Content not covered)	N/A
P2/SD Cards	(Content not covered)	N/A
Video Heads	1 year or 2,000 hrs. (priorated) whichever comes first	1 year or 2,000 hrs. whichever comes first
D5 Video heads	1 year or 1,000 hrs. whichever comes first	1 year or 1,000 hrs. whichever comes first
Maintenance Items	2 years	2 years
Colour Camera CCD Imaging Block	2 years	2 years
All LCD Monitors	2 years (burn-in not covered)	2 years
*DLP™ Monitors	3 years or 17,000 hrs. whichever comes first	3 years or 17,000 hrs. whichever comes first
1 LCD Projectors above 2,500 ANSI Lumens	3 years or 2,500 hrs. whichever comes first	3 years or 2,500 hrs. whichever comes first
*LCD Projectors below 2,500 ANSI Lumens	3 years or 1,500 hrs. whichever comes first	3 years or 1,500 hrs. whichever comes first
Projector Lamps	50% of the rated lamp life or 1 year whichever comes first	50% of the rated lamp life or 1 year whichever comes first
All Plasma displays	3 years (burn-in not covered)	2 years
103 inch Plasma displays	1 year plus balance (if any) of the original Manufacturer's Limited Warranty. (Content not covered)	3 years
Hard Drive Disk Unit	3 years	1 year

\* Dust, smoke, rental/staging environment and twenty-four/seven operation, dramatically decreases the interval between performances of routine preventive maintenance required to maintain this warranty coverage.

**Warranty Service**

If the product needs to be shipped for service, carefully pack (preferably in the original carton) and enclose a letter, detailing the complaint. Send prepaid and adequately insured to the local authorized Panasonic Service Centre in your area or to Panasonic Technical Support and Product Services Department, 5770 Ambler Drive, Mississauga, Ontario, L4W 2T3. Shipping to the latter location requires a return authorization before shipment. No liability is assumed for loss or damage to the product while in transit.

# Customer Service

## Customer Service Directory

Obtain products information and operative assistant; localize the closer distributor or Service Center; buy spare parts and accessories by our web site to Latin American:

**<http://www.lar.panasonic.com>**

Also you may contact us directly by our Contact Center:

<b>Panama</b>	<b>800-PANA (800-7262)</b>
<b>Colombia</b>	<b>01-8000-94PANA (01-8000-947262)</b>
<b>Ecuador</b>	<b>1800-PANASONIC (1800-726276)</b>
<b>Costa Rica</b>	<b>800-PANA737 (800-7262737)</b>
<b>El Salvador</b>	<b>800-PANA (800-7262)</b>
<b>Guatemala</b>	<b>1-801-811-PANA (1-801-811-7262)</b>
<b>Chile</b>	<b>800-390-602</b>
	<b>From a cell phone: 797-5000</b>
<b>Venezuela</b>	<b>800-PANA-800 (800-7262-800)</b>
<b>Uruguay</b>	<b>0-800-PANA (0-800-7262)</b>
<b>Peru</b>	<b>0-800-00-PANA (0-800-00726)</b>
<b>Argentina</b>	<b>0800-333-PANA (0800-333-7262)</b>
	<b>0810-321-PANA (0810-321-7262)</b>
<b>Paraguay</b>	<b>800-11-PANA (800-11-7262)</b>
<b>Dominican Republic</b>	<b>809-200-8000</b>

## Mexico Service

To obtain information in the Republic of Mexico contact us at:

**[email: atencion.clientes@mx.panasonic.com](mailto:atencion.clientes@mx.panasonic.com)**

**<http://www.panasonic.com.mx>**

Or you may contact us in the next following phones numbers:

**01800-VIP-PANA (01800-847-7262) - Interior**

**(55) 5000-1200 - Mexico D.F. and Metropolitan Area**



## Disposal of Old Equipment and Batteries

### Only for European Union and countries with recycling systems



These symbols on the products, packaging, and/or accompanying documents mean that used electrical and electronic products and batteries must not be mixed with general household waste. For proper treatment, recovery and recycling of old products and used batteries, please take them to applicable collection points in accordance with your national legislation.

By disposing of them correctly, you will help to save valuable resources and prevent any potential negative effects on human health and the environment.

For more information about collection and recycling, please contact your local authority. Penalties may be applicable for incorrect disposal of this waste, in accordance with national legislation.



#### Note for the battery symbol (bottom symbol)

This symbol might be used in combination with a chemical symbol. In this case it complies with the requirement set by the Directive for the chemical involved.

## Product Information (for Turkey only)



AEEE Yönetmeliğine Uygundur.

Eski Ekipman ve Bataryaların İşlenmesi.

Sadece geri dönüşüm sistemleri olan Avrupa Birliği ve ülkeleri için geçerlidir.

Ürünler, ambalaj ve/veya ekli belgeler üzerindeki bu semboller kullanılmış elektrik ve elektronik ürünlerin ve pillerin genel ev atığı ile karıştırılmaması gerektiğini ifade eder.

Eski ürünlerin ve pillerin toplanması ve geri kazanılması için bu atıkları lütfen yasayla belirlenmiş olan uygun toplama merkezlerine teslim ediniz.

Bu atıkların doğru işlenmesiyle, değerli kaynakların korunmasına ve insan sağlığı ve çevreye olası negatif etkilerinin engellenmesine yardımcı olabilirsiniz.

Atıkların toplanması ve geri dönüşümü için detaylı bilgi için lütfen bağlı olduğunuz yerel yönetimlerle iletişime geçiniz.

Atıkların atılmasıyla ilgili yanlış uygulamalar yasayla belirlenmiş olan cezalara sebebiyet verebilir.



Notice (U.S.A. only)

Disposal may be regulated in your community due to environmental considerations. For disposal or recycling information, please visit Panasonic website:  
<https://holdings.panasonic/global/corporate/sustainability.html>  
or call 1-888-769-0149.

**Customer's Record**

The model number and serial number of this product may be found on its rear panel. You should note this serial number in the space provided below and retain this book, plus your purchase receipt, as a permanent record of your purchase to aid in identification in the event of theft or loss, and for Warranty Service purposes.

**Model Number**

**Serial Number**

---

**Panasonic Connect North America**

Unit of Panasonic Corporation of North America

**Executive Office :**

Two Riverfront Plaza, Newark, New Jersey 07102

**Panasonic Canada Inc.**

5770 Ambler Drive, Mississauga, Ontario L4W 2T3

Authorized Representative in EU:

Panasonic Connect Europe GmbH

Panasonic Testing Centre

Winsbergring 15, 22525 Hamburg, Germany

Importer for UK:

Panasonic Connect UK,

a branch of Panasonic Connect Europe GmbH,

Maxis 2, Western Road, Bracknell, Berkshire, RG12 1RT

---

**Panasonic Connect Co., Ltd.**

4-1-62 Minoshima, Hakata-ku, Fukuoka 812-8531, Japan

Web Site: <https://panasonic.net/cns/prodisplays/>

© Panasonic Connect Co., Ltd. 2022

English

Printed in China