

Specifications

Main unit

Power supply		AC 100-240 V, 50 Hz/60 Hz (Taiwan: AC 110 V, 60 Hz)																																										
Power consumption*1		465 W (5.0 A-2.0 A)																																										
	OPERATING MODE	[NORMAL]	370 W																																									
		[ECO]	295 W																																									
		[QUIET]	295 W																																									
	STANDBY MODE	[NORMAL]	<DC OUT> terminal not in use: 10 W [IN STANDBY MODE] set to [OFF], [QUICK STARTUP] set to [OFF], and <DC OUT> terminal in use: 25 W [IN STANDBY MODE] set to [ON], [QUICK STARTUP] set to [OFF], and <DC OUT> terminal in use: 35 W [IN STANDBY MODE] set to [ON], [QUICK STARTUP] set to [ON], and <DC OUT> terminal in use: 65 W																																									
	[ECO]	Approx. 0.5 W																																										
BTU value		Max. 1,587 BTU																																										
DLP™ chip	Panel size	17.0 mm [0.67 in] diagonal (16:10 aspect ratio)																																										
	Projection system	DLP™ chip x 1, DLP™ projection system																																										
	Pixels	2,304,000 (1920 x 1200 pixels)																																										
Light source		Laser diodes																																										
Light output		5,000 lm (ANSI)*2/5,200 lm (Center)*3 When [PICTURE MODE] is set to [DYNAMIC], [DAYLIGHT VIEW] is set to [OFF], [DYNAMIC CONTRAST] is set to [OFF], [LIGHT OUTPUT] is set to [100%] and [AUTO POWER SAVE] is set to [OFF]																																										
Time until light output declines to 50%*4		20,000 hours																																										
Resolution		1920 x 1200 pixels																																										
Contrast ratio*2		20,000:1 (All White/All Black) [PICTURE MODE] is set to [DYNAMIC], [OPERATING MODE] is set to [NORMAL], Dynamic Contrast 1																																										
Screen size (diagonal)		1.02-7.62 m [40-300 in], 16:10 aspect ratio																																										
Center to corner zone ratio*2		Fixed: 0.8:1 Electric focus: F=1.75 mm, f=11.9 mm																																										
Lens		Fixed zoom/Auto Focus lenses (Short throw) (0.8:1)																																										
Lens shift (From the origin point of the lens mounter)	Vertical (from center of screen)	±4.4% (powered)																																										
	Horizontal (from center of screen)	±2.1% (powered)																																										
Geometry Correction Range		<table border="1"> <tr> <td colspan="2">[VERTICAL KEYSTONE] (viewed from the side)</td> <td colspan="2">[HORIZONTAL KEYSTONE] (viewed from above)</td> </tr> <tr> <td colspan="2"></td> <td colspan="2"></td> </tr> <tr> <td colspan="2">Vertical arc correction (viewed from the side)</td> <td colspan="2">Horizontal arc correction (viewed from above)</td> </tr> <tr> <td colspan="2"></td> <td colspan="2"></td> </tr> <tr> <td colspan="2"></td> <td colspan="2"></td> </tr> <tr> <td colspan="2">Only [KEYSTONE] used</td> <td colspan="2">[KEYSTONE] and [CURVED] used together</td> <td colspan="2">Only [CURVED] used</td> </tr> <tr> <td>Vertical keystone correction angle α (°)</td> <td>Horizontal keystone correction angle β (°)</td> <td>Vertical keystone correction angle α (°)</td> <td>Horizontal keystone correction angle β (°)</td> <td>Min. value of R2/L2</td> <td>Min. value of R3/L3</td> <td>Min. value of R2/L2</td> <td>Min. value of R3/L3</td> </tr> <tr> <td>±25</td> <td>±20</td> <td>±8</td> <td>±8</td> <td>1.7</td> <td>4.3</td> <td>1.0</td> <td>2.6</td> </tr> </table> <ul style="list-style-type: none"> When [SCREEN ADJUSTMENT] is used, the focus of the entire screen may be lost as correction increases. Make the curved screen a circular arc shape with one part of a perfect circle removed. 	[VERTICAL KEYSTONE] (viewed from the side)		[HORIZONTAL KEYSTONE] (viewed from above)						Vertical arc correction (viewed from the side)		Horizontal arc correction (viewed from above)										Only [KEYSTONE] used		[KEYSTONE] and [CURVED] used together		Only [CURVED] used		Vertical keystone correction angle α (°)	Horizontal keystone correction angle β (°)	Vertical keystone correction angle α (°)	Horizontal keystone correction angle β (°)	Min. value of R2/L2	Min. value of R3/L3	Min. value of R2/L2	Min. value of R3/L3	±25	±20	±8	±8	1.7	4.3	1.0	2.6
[VERTICAL KEYSTONE] (viewed from the side)		[HORIZONTAL KEYSTONE] (viewed from above)																																										
Vertical arc correction (viewed from the side)		Horizontal arc correction (viewed from above)																																										
Only [KEYSTONE] used		[KEYSTONE] and [CURVED] used together		Only [CURVED] used																																								
Vertical keystone correction angle α (°)	Horizontal keystone correction angle β (°)	Vertical keystone correction angle α (°)	Horizontal keystone correction angle β (°)	Min. value of R2/L2	Min. value of R3/L3	Min. value of R2/L2	Min. value of R3/L3																																					
±25	±20	±8	±8	1.7	4.3	1.0	2.6																																					
Installation		Ceiling/floor, front/rear																																										

Compatible Signal	Video input	● Horizontal: 15.73 kHz, Vertical: 59.94 Hz	
	Y/C input	● Horizontal: 15.63 kHz, Vertical: 50 Hz	
	RGB input	● Resolution: 640 x 400 to 1920 x 1200 ● Dot clock frequency: 162 MHz or less ● PIAS (Panasonic Intelligent Auto Scanning) system	
	YCbCr/YPbPr input	● Resolution: 480i/576i to 1920 x 1080 ● Dot clock frequency: 148.5 MHz or less ● The HD/SYNC and VD terminals do not support 3 value SYNC.	
	HDMI input	● Moving image signal resolution: 480i*5/576i*5 to 4096 x 2160 Still image signal resolution: 640 x 400 to 1920 x 1200 (non-interlace) ● Dot clock frequency: 25 MHz to 594 MHz	
	DIGITAL LINK input	● Moving image signal resolution: 480i*5/576i*5 to 4096 x 2160 Still image signal resolution: 640 x 400 to 1920 x 1200 (non-interlace) ● Dot clock frequency: 25 MHz to 297 MHz	
Terminals	COMPUTER 1 IN		D-sub HD 15-pin (female) x 1
	RGB signal	0.7 V [p-p] 75 Ω (SYNC ON GREEN: 1.0 V [p-p] 75 Ω)	SYNC/HD TTL high impedance, automatic positive/negative polarity compatible
		VD	TTL high impedance, automatic positive/negative polarity compatible
		YPbPr signal	Y: 1.0 V [p-p] including synchronization signal, PbPr: 0.7 V [p-p] 75 Ω
	Y/C signal	Y: 1.0 V [p-p], C: 0.286 V [p-p] 75 Ω	
	COMPUTER 2 IN/1 OUT		D-sub HD 15-pin (female) x 1
	RGB signal	0.7 V [p-p] 75 Ω (SYNC ON GREEN: 1.0 V [p-p] 75 Ω)	SYNC/HD TTL high impedance, automatic positive/negative polarity compatible
		VD	TTL high impedance, automatic positive/negative polarity compatible
	YPbPr signal	Y: 1.0 V [p-p] including synchronization signal, PbPr: 0.7 V [p-p] 75 Ω	
	HDMI 1 IN/HDMI 2 IN		HDMI 19-pin x 2 Compatible with HDCP 2.3, Deep Color, 4K/60p signal input*6, CEC supported
	Audio signal	Linear PCM (sampling frequency: 48 kHz/44.1 kHz/32 kHz)	
	VIDEO IN	pin jack x 1	1.0 V [p-p] 75 Ω
	AUDIO IN 1	pin jack x 2 (L-R)	0.5 V [rms], input impedance 22 kΩ or more
	AUDIO IN 2/AUDIO IN 3	M3 stereo mini jack x 2	0.5 V [rms], input impedance 22 kΩ or more
	VARIABLE AUDIO OUT	M3 stereo mini jack x 1 (monitor output, stereo compatible)	0 V [rms] to 1.80 V [rms] (variable), output impedance 2.2 kΩ or less
SERIAL IN	D-Sub 9 p x 1	RS-232C compliant, for computer control	
DIGITAL LINK/LAN	RJ-45 x 1	for network and DIGITAL LINK connections (HDBaseTTM compliant), PJLink (class 2) compatible, 100Base-TX, Art-Net compatible, HDCP 2.3 compatible, Deep Color compatible, 4K/60p signal input*6	
LAN	RJ-45 x 1	for network connection, PJLink (class 2) compatible, 10Base-T/100Base-TX, Art-Net compatible	
DC OUT	USB connector (type A) x 1	for power supply only (DC 5 V, maximum 2 A)	
Power cord length	3.0 m [118-1/8 in], 2.0 m [78-3/4 in] (for Taiwan)		
Cabinet materials	Molded plastic		
Dimension (W x H x D)	498 x 168*7 x 481 mm [19-5/8 x 6-5/8*7 x 18-15/16 in]		
Weight*8	Approx. 16.4 kg (36.2 lbs)		
Operating noise*2	32 dB [NORMAL] / 27 dB [QUIET]		
Operating environment	Operating temperature	0-45 °C (32-113 °F)*9	
	Operating humidity	10-80% (no condensation)	
Laser Classification	Laser Class	Class 1 (IEC/EN 60825-1:2014)	
	Risk Group	Risk Group 2 (IEC 62471-5:2015)	

Remote control unit

Power supply	3V DC (AAA/R03/LR03 battery x 2)
Operation range	Approx. 30 m [98 ft 5 in] (when operated directly in front of signal receiver)
Dimensions (W x H x D)	48 x 145 x 27 mm [1-7/8 x 5-23/32 x 1-1/16 in]
Weight	Approx. 102 g (3.60 ozs.) including batteries

1-Chip DLP™ Projectors

Other Applications

Multi Monitoring Control Software (for Windows)
Logo Transfer Software (for Windows)

Supplied accessories

Wireless remote control unit (x 1)
Power cord with secure lock (x 1) (x 2 for Europe/ASIA models)
Batteries for remote control (AAA/R03 or AAA/LR03 battery x 2)

Optional accessories

Ceiling Mount Bracket	ET-PKD120H (for high ceiling) ET-PKD120S (for low ceiling)
Projector Mount Bracket	ET-PKD130B
DIGITAL LINK Switcher	ET-YFB200G
Digital Interface Box	ET-YFB100G
Early Warning Software	ET-SWA100 Series *The suffix of the Model No. differs according to the license type.
D-sub/S-VIDEO Conversion Cable	ET-ADSV

*1 Operating Temperature 25 °C(77 °F), Altitude 700 m (2297 ft), IEC62087:2008 Broadcast contents, Picture Mode: Standard, Dynamic Contrast [2].

*2 Measurement, measuring conditions, and method of notation all comply with ISO/IEC 21118: 2020 international standards. Value is average of all products when shipped.

*3 Average light-output value of all shipped products measured at center of screen in NORMAL Mode.

*4 Around this time, light output will have decreased by approximately 50%. IEC62087: 2008 Broadcast contents, NORMAL Mode, Dynamic Contrast [2], under conditions with 30°C (86°F), 700m (2,297ft) above sea level, and 0.15 mg/m³ of particulate matter. Estimated time until light output declines to 50% varies depending on environment.

*5 Only dot clock frequency 27MHz (Pixel Repetition signal) is supported.

*6 4K/60p input signal is converted to projector's resolution (1920 x 1200).

*7 With legs at shortest position.

*8 Average value. May differ depending on the actual unit.

*9 The operating environment temperature should be between 0°C (32°F) and 40°C (104°F) if the projector is used at an altitude between 1400m (4593ft) and 4200m (13780ft) above sea level.

When the [PROJECTOR SETUP] menu → [ECO MANAGEMENT] → [OPERATING MODE] is set to [ECO] or [QUIET], the projector cannot be used at an altitude of 2700m (8858ft) or higher above sea level.

When using the projector at an altitude lower than 2700m (8858ft) above sea level, and the operating environment temperature becomes 30°C (86°F) or higher, the light output may be reduced to protect the projector.

When using the projector at an altitude between 2700m (8858ft) and 4200m (13780ft), and the operating environment temperature becomes 25°C (77°F) or higher, the light output may be reduced to protect the projector.

Dimensions

unit : mm (inch)
NOTE: This illustration is not drawn to scale.

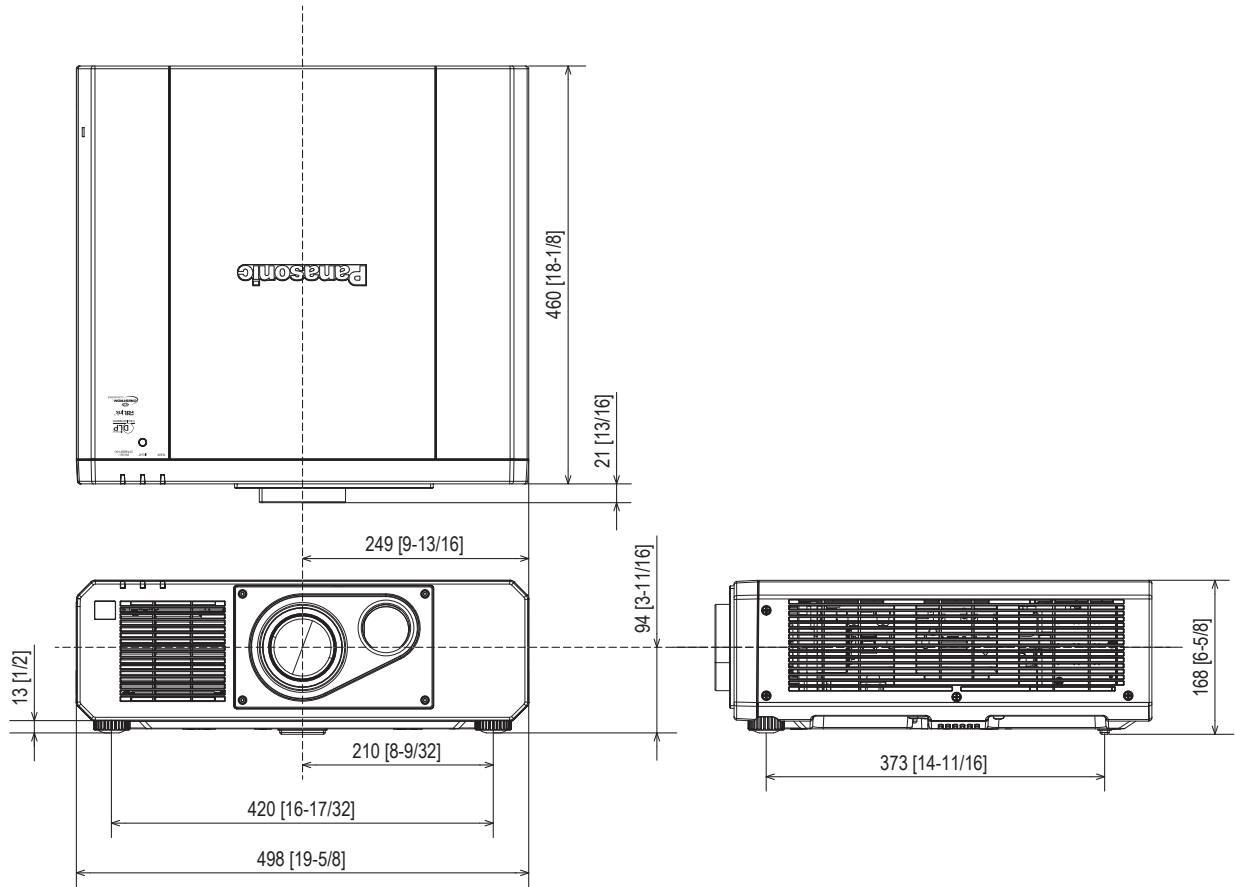

Terminals

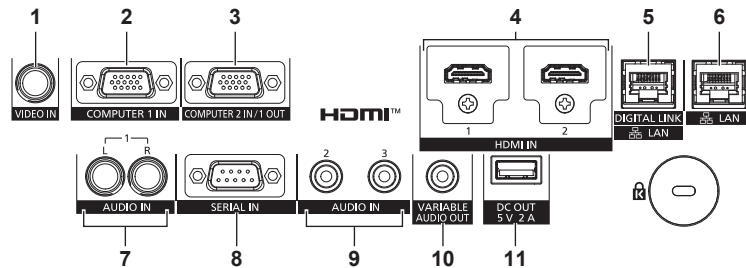

1	VIDEO IN	7	AUDIO IN 1
2	COMPUTER 1 IN	8	SERIAL IN
3	COMPUTER 2 IN/1 OUT	9	AUDIO IN 2/AUDIO IN 3
4	HDMI 1 IN/HDMI 2 IN	10	VARIABLE AUDIO OUT
5	DIGITAL LINK/LAN	11	DC OUT
6	LAN		

Projected image and throw distance

Install the projector referring to the projected image size and projection distance. Image size and image position can be adjusted in accordance with the screen size and screen position.

- Following illustration is prepared on the assumption that the projected image size and position have been aligned to fit full in the screen.

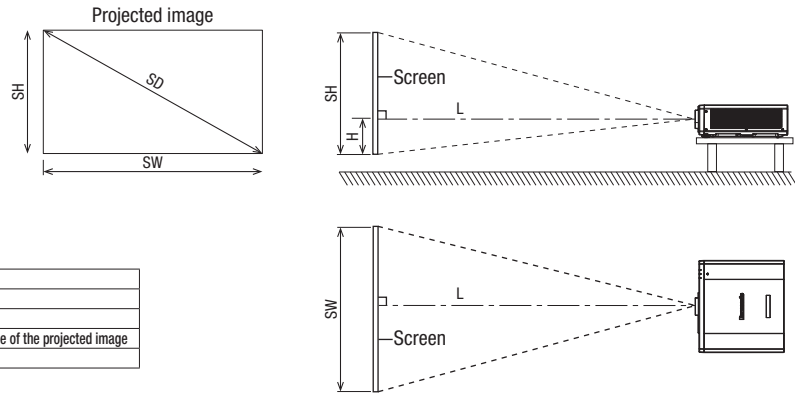

L	Projection distance
SH	Projected image height
SW	Projected image width
H	Distance from the lens center to the bottom edge of the projected image
SD	Projected image size

Standard setting-up position

Illustrations show the projector installed using optional ceiling mount bracket ET-PKD120H, optional bracket assembly ET-PKD130B.

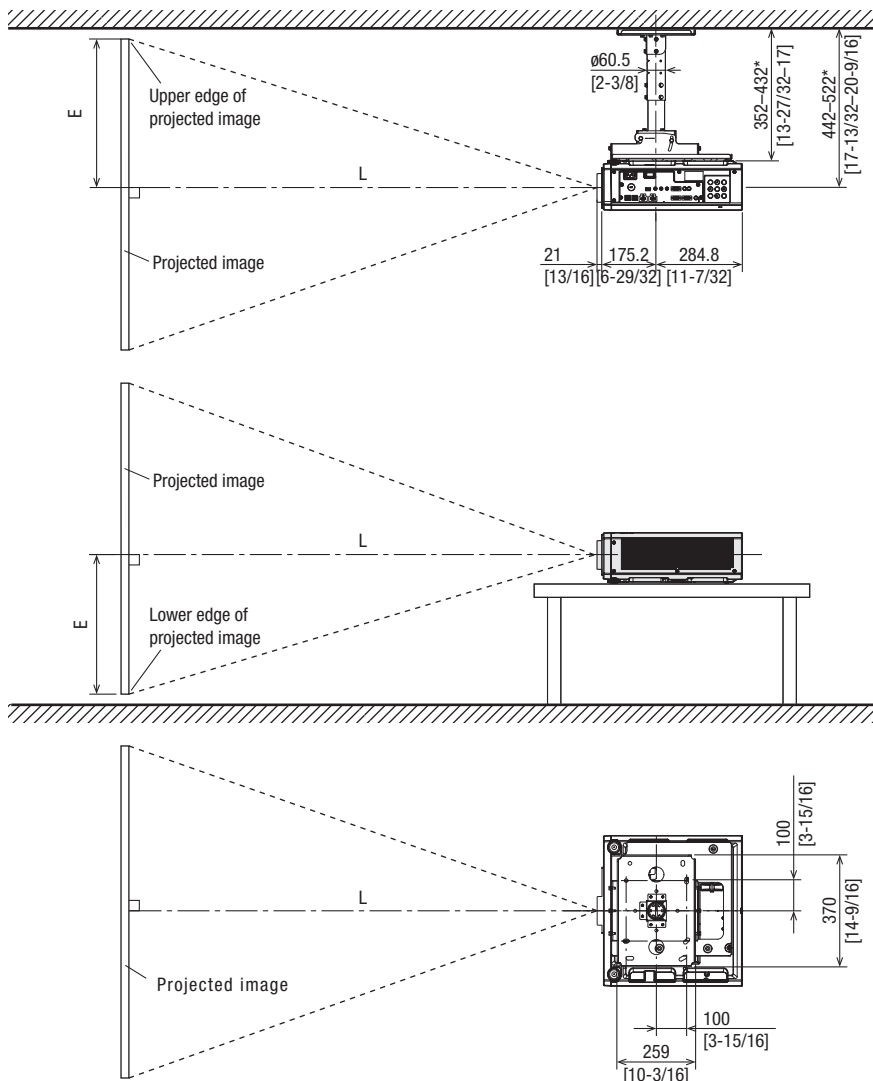

unit : mm (inch)
 NOTE: This illustration is not drawn to scale.
 * Adjustable in 40 mm [1-9/16 in] steps.

Caution

- All construction work should be done by a qualified technician.
- When mounting to the ceiling, use the special mounting bracket. Furthermore, in order to prevent it from falling down from the ceiling, use the supplied wire on the mounting bracket.

Projection distance

A ±5% error in listed projection distances may occur.

When [SCREEN ADJUSTMENT] is used, distance is corrected to become smaller than the specified image size.

Unit: m

Projected image size Diagonal (SD)	Aspect ratio 16:10		Aspect ratio 16:9		Aspect ratio 4:3	
	Projection distance (L)	Height position (H)	Projection distance (L)	Height position (H)	Projection distance (L)	Height position (H)
1.02/ 40	0.65	0.26 - 0.28	0.67	0.24 - 0.26	0.75	0.29 - 0.32
1.27/ 50	0.83	0.32 - 0.35	0.85	0.30 - 0.33	0.94	0.36 - 0.40
1.52/ 60	1.00	0.39 - 0.42	1.03	0.36 - 0.39	1.14	0.44 - 0.48
1.78/ 70	1.18	0.45 - 0.49	1.21	0.42 - 0.46	1.34	0.51 - 0.56
2.03/ 80	1.35	0.51 - 0.56	1.39	0.48 - 0.52	1.54	0.58 - 0.64
2.29/ 90	1.53	0.58 - 0.63	1.57	0.54 - 0.59	1.74	0.66 - 0.72
2.54/100	1.70	0.64 - 0.70	1.75	0.60 - 0.65	1.93	0.73 - 0.80
3.05/120	2.05	0.77 - 0.84	2.11	0.71 - 0.78	2.33	0.87 - 0.95
3.81/150	2.58	0.97 - 1.05	2.65	0.89 - 0.98	2.93	1.09 - 1.19
5.08/200	3.45	1.29 - 1.41	3.55	1.19 - 1.30	3.92	1.46 - 1.59
6.35/250	4.33	1.61 - 1.76	4.45	1.49 - 1.63	4.91	1.82 - 1.99
7.62/300	5.20	1.93 - 2.11	5.35	1.79 - 1.95	5.90	2.19 - 2.39

Unit: feet

Projected image size Diagonal (SD)	Aspect ratio 16:10		Aspect ratio 16:9		Aspect ratio 4:3	
	Projection distance (L)	Height position (H)	Projection distance (L)	Height position (H)	Projection distance (L)	Height position (H)
1.02/ 40	2.13	0.85 - 0.92	2.20	0.79 - 0.85	2.46	0.95 - 1.05
1.27/ 50	2.72	1.05 - 1.15	2.79	0.98 - 1.08	3.08	1.18 - 1.31
1.52/ 60	3.28	1.28 - 1.38	3.38	1.18 - 1.28	3.74	1.44 - 1.57
1.78/ 70	3.87	1.48 - 1.61	3.97	1.38 - 1.51	4.40	1.67 - 1.84
2.03/ 80	4.43	1.67 - 1.84	4.56	1.57 - 1.71	5.05	1.90 - 2.10
2.29/ 90	5.02	1.90 - 2.07	5.15	1.77 - 1.94	5.71	2.17 - 2.36
2.54/100	5.58	2.10 - 2.30	5.74	1.97 - 2.13	6.33	2.39 - 2.62
3.05/120	6.73	2.53 - 2.76	6.92	2.33 - 2.56	7.64	2.85 - 3.12
3.81/150	8.46	3.18 - 3.44	8.69	2.92 - 3.22	9.61	3.58 - 3.90
5.08/200	11.32	4.23 - 4.63	11.65	3.90 - 4.27	12.86	4.79 - 5.22
6.35/250	14.21	5.28 - 5.77	14.60	4.89 - 5.35	16.11	5.97 - 6.53
7.62/300	17.06	6.33 - 6.92	17.55	5.87 - 6.40	19.36	7.18 - 7.84

Calculation of the projection distance

To use a projected image size not listed in this manual, check the projected image size SD (m) and use the respective formula to calculate the value.

The unit of all the formulae is m. (Values obtained by the following calculation formulae contain a slight error.)

When calculating the value using image size designation (value in inches), multiply the value in inches by 0.0254 and substitute it into SD in the formula.

	Aspect ratio 16:10	Aspect ratio 16:9	Aspect ratio 4:3
Projected image size Height (SH)	= SD x 0.530	= SD x 0.490	= SD x 0.6
Projected image size Width (SW)	= SD x 0.848	= SD x 0.872	= SD x 0.8
Projection distance (L)	= 0.6892 x SD - 0.0474	= 0.7084 x SD - 0.0474	= 0.7802 x SD - 0.0474

Adjustment range by the lens position shift (optical shift)

Perform the lens position shift within the adjustment range.

Part of the peripheral image may not be visible or the focus may change when the lens position is shifted outside the adjustment range, but this is not a malfunction.

This projector is equipped with the optical axis shift function, and projection position can be adjusted within the range indicated in the following figure based on the position of the projected screen in the home position (standard projection position).

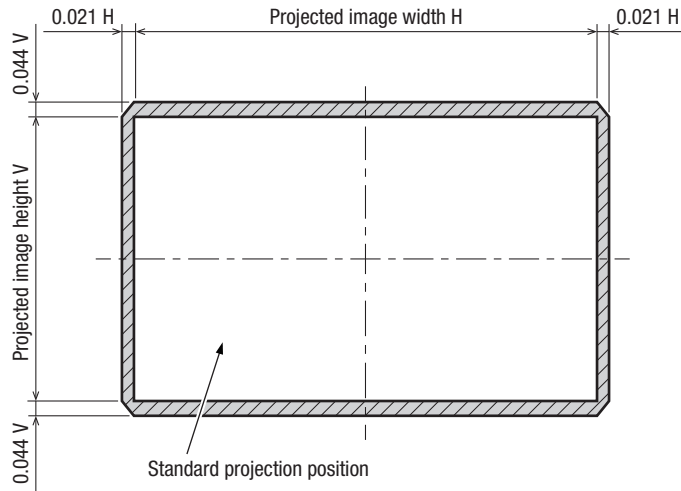

Installable angle

Install the projector at an angle within the range shown below.

Projection in all 360° direction

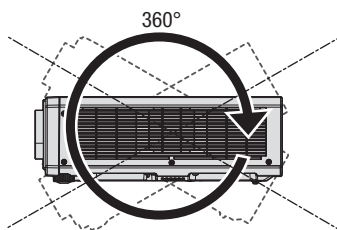

360° vertically

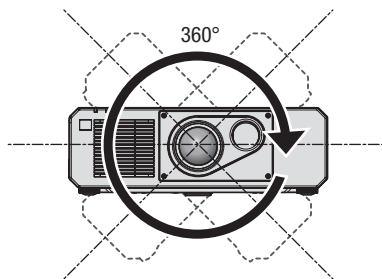

360° horizontally

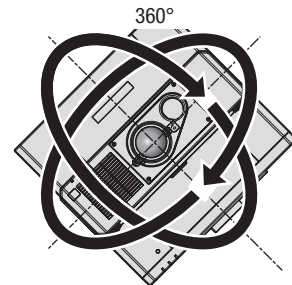

360° tilted
(combination of vertical and horizontal)

Cautions when setting up the projector

- Do not stack projectors on top of each other.
- Do not use the projector supporting it by the top.
- Do not block the intake and exhaust vents of the projector.
- Prevent hot and cool air from the air conditioning system to blow directly to the intake and exhaust vents of the projector.

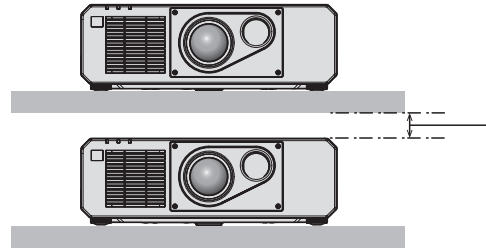
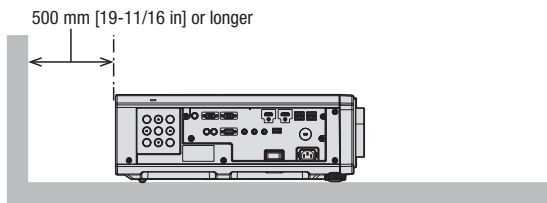
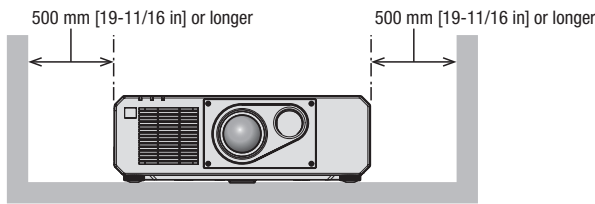
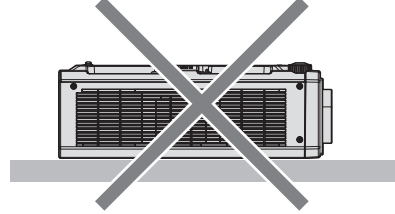
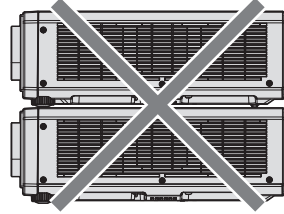

100 mm [3-15/16 in] or longer

- Do not install the projector in a confined space.
When installing the projector in a confined space, provide air conditioning or ventilation separately. Exhaust heat may accumulate when the ventilation is not enough, triggering the protection circuit of the projector.

1-Chip DLP™ Projectors

List of compatible signals

The following table specifies the video signals compatible with the projector.

- Symbols that indicate formats are as follows.
 -V: VIDEO, Y/C -R: RGB (analog) -Y: YCbCr/YPbPr (analog) -H: HDMI -DL: DIGITAL LINK
- Input corresponding to each item in the plug and play column is as follows.
 -COMPUTER: COMPUTER1/COMPUTER2 input -HDMI: HDMI1/HDMI2 input -DIGITAL LINK: DIGITAL LINK input

Signal name (SIGNAL FORMAT)	Resolution (Dots)	Scanning freq.		Dot clock freq. (MHz)	Format	Plug and play*1						
		Horizontal (kHz)	Vertical (Hz)			COMPUTER	HDMI			DIGITAL LINK		
							4K/60P	4K/30P	2K	4K/60P	4K/30P	2K
NTSC/NTSC4.43/ PAL-M/PAL60	720 x 480i	15.7	59.9	-	V	-	-	-	-	-	-	-
PAL/PAL-N/SECAM	720 x 576i	15.6	50.0	-	V	-	-	-	-	-	-	-
480/60i	720 x 480i	15.7	59.9	13.5	R/Y	-	-	-	-	-	-	-
576/50i	720 x 576i	15.6	50.0	13.5	R/Y	-	-	-	-	-	-	-
480/60i	720(1440) x 480i*2	15.7	59.9	27.0	H/DL	-	-	-	-	-	-	-
576/50i	720(1440) x 576i*2	15.6	50.0	27.0	H/DL	-	-	-	-	-	-	-
480/60p	720 x 480	31.5	59.9	27.0	R/Y/H/DL	-	✓	✓	✓	✓	✓	✓
576/50p	720 x 576	31.3	50.0	27.0	R/Y/H/DL	-	✓	✓	✓	✓	✓	✓
720/60p	1280 x 720	45.0	60.0	74.3	R/Y/H/DL	-	✓	✓	✓	✓	✓	✓
720/50p	1280 x 720	37.5	50.0	74.3	R/Y/H/DL	-	✓	✓	✓	✓	✓	✓
1080/60i	1920 x 1080i	33.8	60.0	74.3	R/Y/H/DL	-	✓	✓	✓	✓	✓	✓
1080/50i	1920 x 1080i	28.1	50.0	74.3	R/Y/H/DL	-	✓	✓	✓	✓	✓	✓
1080/24p	1920 x 1080	27.0	24.0	74.3	R/Y/H/DL	-	✓	✓	✓	✓	✓	✓
1080/24sF	1920 x 1080i	27.0	48.0	74.3	R/Y/H/DL	-	-	-	-	-	-	-
1080/25p	1920 x 1080	28.1	25.0	74.3	R/Y/H/DL	-	-	-	-	-	-	-
1080/30p	1920 x 1080	33.8	30.0	74.3	R/Y/H/DL	-	-	-	-	-	-	-
1080/60p	1920 x 1080	67.5	60.0	148.5	R/Y/H/DL	-	-	-	-	-	-	-
1080/50p	1920 x 1080	56.3	50.0	148.5	R/Y/H/DL	-	-	-	-	-	-	-
3840 x 2160/24p	3840 x 2160	54.0	24.0*5	297.0	H/DL	-	✓	✓	✓	✓	✓	✓
3840 x 2160/25p	3840 x 2160	56.3	25.0	297.0	H/DL	-	✓	✓	✓	✓	✓	✓
3840 x 2160/30p	3840 x 2160	67.5	30.0*5	297.0	H/DL	-	✓	✓	✓	✓	✓	✓
3840 x 2160/60p	3840 x 2160*6	135.0	60.0*5	297.0	H/DL	-	✓	-	-	✓	-	-
	3840 x 2160	135.0	60.0*5	594.0	H	-	✓	-	-	-	-	-
3840 x 2160/50p	3840 x 2160*6	112.5	50.0	297.0	H/DL	-	✓	-	-	✓	-	-
	3840 x 2160	112.5	50.0	594.0	H	-	✓	-	-	-	-	-
4096 x 2160/24p	4096 x 2160	54.0	24.0*5	297.0	H/DL	-	✓	✓	✓	✓	✓	✓
4096 x 2160/25p	4096 x 2160	56.3	25.0	297.0	H/DL	-	✓	✓	✓	✓	✓	✓
4096 x 2160/30p	4096 x 2160	67.5	30.0*5	297.0	H/DL	-	✓	✓	✓	✓	✓	✓
4096 x 2160/60p	4096 x 2160*6	135.0	60.0*5	297.0	H/DL	-	✓	-	-	✓	-	-
	4096 x 2160	135.0	60.0*5	594.0	H	-	✓	-	-	-	-	-
4096 x 2160/50p	4096 x 2160*6	112.5	50.0	297.0	H/DL	-	✓	-	-	✓	-	-
	4096 x 2160	112.5	50.0	594.0	H	-	✓	-	-	-	-	-
640 x 400/70	640 x 400	31.5	70.1	25.2	R/H/DL	-	-	-	-	-	-	-
640 x 400/85	640 x 400	37.9	85.1	31.5	R/H/DL	-	-	-	-	-	-	-
640 x 480/60	640 x 480	31.5	59.9	25.2	R/H/DL	✓	✓	✓	✓	✓	✓	✓
640 x 480/67	640 x 480	35.0	66.7	30.2	R/H/DL	-	-	-	-	-	-	-
640 x 480/73	640 x 480	37.9	72.8	31.5	R/H/DL	✓	✓	✓	✓	✓	✓	✓
640 x 480/75	640 x 480	37.5	75.0	31.5	R/H/DL	✓	✓	✓	✓	✓	✓	✓
640 x 480/85	640 x 480	43.3	85.0	36.0	R/H/DL	-	-	-	-	-	-	-
800 x 600/56	800 x 600	35.2	56.3	36.0	R/H/DL	✓	✓	✓	✓	✓	✓	✓
800 x 600/60	800 x 600	37.9	60.3	40.0	R/H/DL	✓	✓	✓	✓	✓	✓	✓
800 x 600/72	800 x 600	48.1	72.2	50.0	R/H/DL	✓	✓	✓	✓	✓	✓	✓
800 x 600/75	800 x 600	46.9	75.0	49.5	R/H/DL	✓	✓	✓	✓	✓	✓	✓
800 x 600/85	800 x 600	53.7	85.1	56.3	R/H/DL	-	-	-	-	-	-	-
832 x 624/75	832 x 624	49.7	74.6	57.3	R/H/DL	✓	✓	✓	✓	✓	✓	✓
1024 x 768/50	1024 x 768	39.6	50.0	51.9	R/H/DL	-	-	-	-	-	-	-
1024 x 768/60	1024 x 768	48.4	60.0	65.0	R/H/DL	✓	✓	✓	✓	✓	✓	✓
1024 x 768/70	1024 x 768	56.5	70.1	75.0	R/H/DL	✓	✓	✓	✓	✓	✓	✓
1024 x 768/75	1024 x 768	60.0	75.0	78.8	R/H/DL	✓	✓	✓	✓	✓	✓	✓
1024 x 768/82	1024 x 768	65.5	81.6	86.0	R/H/DL	-	-	-	-	-	-	-
1024 x 768/85	1024 x 768	68.7	85.0	94.5	R/H/DL	-	-	-	-	-	-	-
1024 x 768/100	1024 x 768	81.4	100.0	113.3	R/H/DL	-	-	-	-	-	-	-
1024 x 768/120	1024 x 768	98.7	120.0	139.1	R/H/DL	✓	✓	✓	✓	✓	✓	✓
1152 x 864/60	1152 x 864	53.7	60.0	81.6	R/H/DL	-	-	-	-	-	-	-
1152 x 864/70	1152 x 864	64.0	70.0	94.2	R/H/DL	-	-	-	-	-	-	-
1152 x 864/75	1152 x 864	67.5	75.0	108.0	R/H/DL	-	-	-	-	-	-	-

Signal name (SIGNAL FORMAT)	Resolution (Dots)	Scanning freq.		Dot clock freq. (MHz)	Format	Plug and play*1						
		Horizontal (kHz)	Vertical (Hz)			COMPUTER	HDMI			DIGITAL LINK		
							4K/60P	4K/30P	2K	4K/60P	4K/30P	2K
1152 x 864/85	1152 x 864	77.1	85.0	119.7	R/H/DL	-	-	-	-	-	-	-
1152 x 870/75	1152 x 870	68.7	75.1	100.0	R/H/DL	✓	✓	✓	✓	✓	✓	✓
1280 x 720/50	1280 x 720	37.1	49.8	60.5	R/H/DL	-	-	-	-	-	-	-
1280 x 720/60	1280 x 720	44.8	59.9	74.5	R/H/DL	-	-	-	-	-	-	-
1280 x 720/100	1280 x 720	76.3	100.0	131.8	R/H/DL	-	-	-	-	-	-	-
1280 x 720/120	1280 x 720	92.6	120.0	161.6	R/H/DL	-	-	-	-	-	-	-
1280 x 768/50	1280 x 768	39.6	49.9	65.3	R/H/DL	-	-	-	-	-	-	-
1280 x 768/60	1280 x 768	47.8	59.9	79.5	R/H/DL	-	-	-	-	-	-	-
	1280 x 768*3	47.4	60.0	68.3	R/H/DL	-	-	-	-	-	-	-
1280 x 768/75	1280 x 768	60.3	74.9	102.3	R/H/DL	-	-	-	-	-	-	-
1280 x 768/85	1280 x 768	68.6	84.8	117.5	R/H/DL	-	-	-	-	-	-	-
1280 x 800/50	1280 x 800	41.3	50.0	68.0	R/H/DL	-	-	-	-	-	-	-
1280 x 800/60	1280 x 800	49.7	59.8	83.5	R/H/DL	-	-	-	-	-	-	-
	1280 x 800*3	49.3	59.9	71.0	R/H/DL	-	-	-	-	-	-	-
1280 x 800/75	1280 x 800	62.8	74.9	106.5	R/H/DL	-	-	-	-	-	-	-
1280 x 800/85	1280 x 800	71.6	84.9	122.5	R/H/DL	-	-	-	-	-	-	-
1280 x 960/60	1280 x 960	60.0	60.0	108.0	R/H/DL	-	-	-	-	-	-	-
1280 x 1024/50	1280 x 1024	52.4	50.0	88.0	R/H/DL	-	-	-	-	-	-	-
1280 x 1024/60	1280 x 1024	64.0	60.0	108.0	R/H/DL	-	-	-	-	-	-	-
1280 x 1024/66	1280 x 1024	72.3	66.3	125.0	R/H/DL	-	-	-	-	-	-	-
1280 x 1024/72	1280 x 1024	78.2	72.0	135.1	R/H/DL	-	-	-	-	-	-	-
1280 x 1024/75	1280 x 1024	80.0	75.0	135.0	R/H/DL	✓	✓	✓	✓	✓	✓	✓
1280 x 1024/85	1280 x 1024	91.1	85.0	157.5	R/H/DL	-	-	-	-	-	-	-
1366 x 768/50	1366 x 768	39.6	49.9	69.0	R/H/DL	-	-	-	-	-	-	-
1366 x 768/60	1366 x 768	47.7	59.8	85.5	R/H/DL	-	-	-	-	-	-	-
1400 x 1050/50	1400 x 1050	54.1	50.0	99.9	R/H/DL	-	-	-	-	-	-	-
1400 x 1050/60	1400 x 1050	64.0	60.0	108.0	R/H/DL	-	-	-	-	-	-	-
	1400 x 1050	65.3	60.0	121.8	R/H/DL	-	-	-	-	-	-	-
	1400 x 1050	65.2	60.0	122.6	R/H/DL	✓	✓	✓	✓	✓	✓	✓
1400 x 1050/72	1400 x 1050	78.8	72.0	149.3	R/H/DL	-	-	-	-	-	-	-
1400 x 1050/75	1400 x 1050	82.2	75.0	155.9	R/H/DL	-	-	-	-	-	-	-
1440 x 900/50	1440 x 900	46.3	49.9	86.8	R/H/DL	-	-	-	-	-	-	-
1440 x 900/60	1440 x 900	55.9	59.9	106.5	R/H/DL	-	-	-	-	-	-	-
1600 x 900/50	1600 x 900	46.4	49.9	96.5	R/H/DL	-	-	-	-	-	-	-
1600 x 900/60	1600 x 900	55.9	60.0	119.0	R/H/DL	✓	✓	✓	✓	✓	✓	✓
1600 x 1200/50	1600 x 1200	61.8	49.9	131.5	R/H/DL	-	-	-	-	-	-	-
1600 x 1200/60	1600 x 1200	75.0	60.0	162.0	R/H/DL	✓	✓	✓	✓	✓	✓	✓
1680 x 1050/50	1680 x 1050	54.1	50.0	119.5	R/H/DL	-	-	-	-	-	-	-
1680 x 1050/60	1680 x 1050	65.3	60.0	146.3	R/H/DL	-	-	-	-	-	-	-
1920 x 1080/50	1920 x 1080	55.6	49.9	141.5	R/H/DL	-	-	-	-	-	-	-
1920 x 1080/60	1920 x 1080*3	66.6	59.9	138.5	R/H/DL	-	-	-	-	-	-	-
	1920 x 1080*4	67.2	60.0	173.0	R	-	-	-	-	-	-	-
1920 x 1200/50	1920 x 1200	61.8	49.9	158.3	R/H/DL	-	-	-	-	-	-	-
1920 x 1200/60	1920 x 1200*4	74.6	59.9	193.3	R	-	-	-	-	-	-	-
	1920 x 1200*3	74.0	60.0	154.0	R/H/DL	✓	✓	✓	✓	✓	✓	✓

*1 Signal with ✓ in the plug and play column is a signal described in the EDID (extended display identification data) of the projector. The signal that does not have ✓ in the plug and play column can also be input if it is described in the format column. The resolution may not be selected in the computer even if the projector is compatible for the signal that does not have ✓ in the plug and play column.

*2 Pixel-Repetition signal (dot clock frequency 27.0 MHz) only

*3 VESA CVT-RB (Reduced Blanking)-compliant

*4 Samples the pixels in the image processing circuit and projects the image.

*5 The signal with 1/1.001x vertical scanning frequency is also supported.

*6 YPbPr 4:2:0 format only

Note

- A signal with a different resolution is converted to the number of display dots. The number of display dots is as follows.
-1920 x 1200
- The "i" at the end of the resolution indicates an interlaced signal.
- When interlaced signals are connected, flickering may occur on the projected image.
- Even if it is the signal listed in the list of compatible signals, it may not be displayed by the projector if the video signal is recorded in a special format.