

Panasonic

ideas for life

PT-ST10U
LCD Projector

Easy, Close-Range Projection for Versatile Applications



More Flexible Images with a Short-Throw Projector. An Ideal Combination with an Interactive Whiteboard.

This compact projector makes large-screen images easier to use, and helps lectures and presentations go more smoothly. The PT-ST10U features a newly developed short-throw lens. This allows installation methods to be used that were not possible with conventional models, for a wider range of application. Close range projection also reduces shadows on the screen. This all adds up to more relaxed, comfortable viewing.

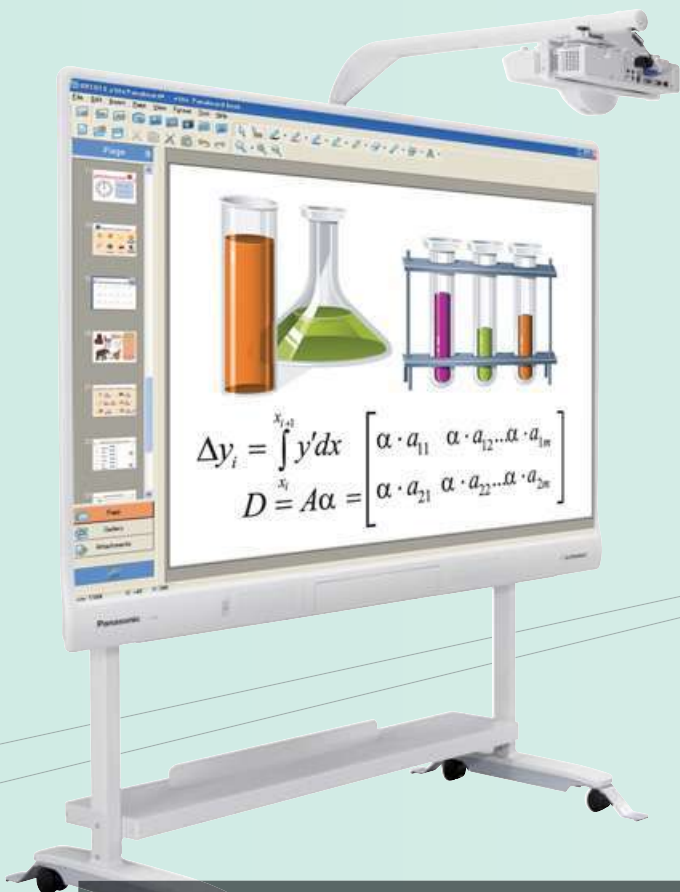
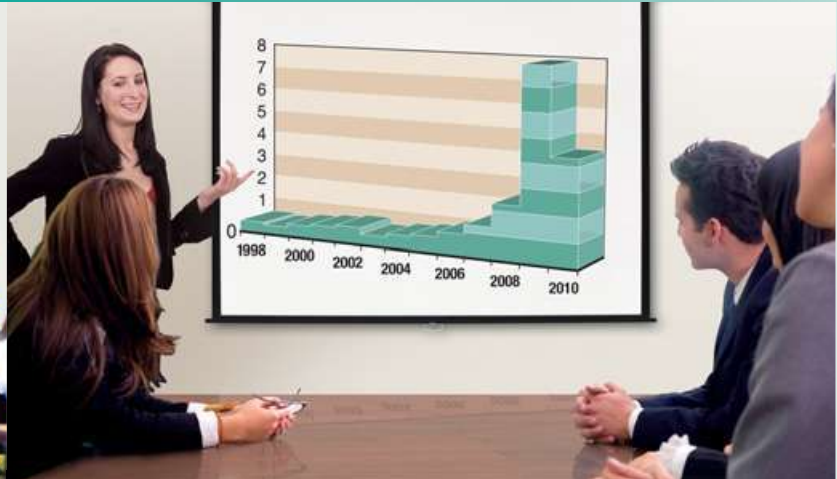

Combines with an Interactive Whiteboard for Even More Effective Use.

The PT-ST10U mounts easily to Panasonic's elite Panaboard. With the Up/Down Stand Kit, the projector and elite Panaboard form a neat, integrated unit. It also makes it easy to adjust the height of the elite Panaboard and to move it as desired.

*An optional short-throw arm unit is required. See page 4 for compatible models and other details.

Project onto a Large, 80-Inch Screen with a Projection Distance of 0.82 m (2.69').

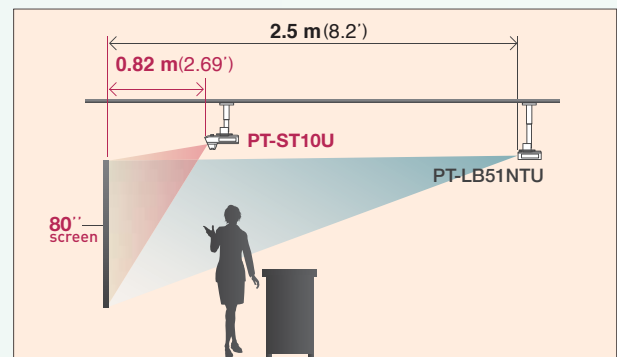

The PT-ST10U, which is equipped with the newly developed short-throw lens, lets you project images onto a large, 80-inch screen from a distance of only 0.82 m (2.69'). This greatly increases the projector's range of use.

Fewer Shadows on the Screen. More Comfortable Presentations.

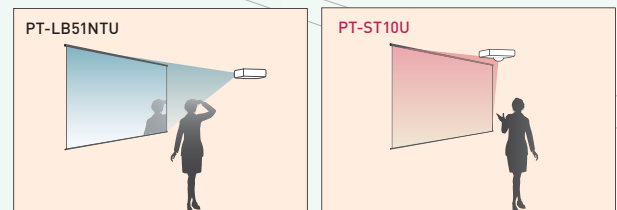

The close range projection of the PT-ST10U reduces the chance of the presenter standing in front of the projection light and casting a shadow on the screen. Also, presentations are more comfortable because the presenter is not affected by the glare of the projection light.

PT-ST10U

2800 lm

XGA

High Basic Performance, Including a 5,000-hour*¹ Lamp Replacement Cycle

The New Lamp Drive System Enables a 5,000-hour*¹ Lamp Replacement Cycle

Panasonic employs a number of advanced technologies — including a proprietary lamp drive system — that help maintain lamp performance. This has resulted in a 5,000-hour*¹ lamp replacement cycle. It helps saving operating cost by providing longer usage between lamp replacements.



Intelligent Power Management Function Allows Resistance to Sudden Voltage Fluctuations*²

Momentary power outages*³ or voltage drops*⁴ can cause the projector to shut down, interrupting the projection. The PT-ST10U equipped with the Intelligent Power Management function controls the power supply to cope with power fluctuations, to enable continued projection.



Low Standby Power Consumption of 0.4 W*⁵ Helps the Environment

The ecological design of the PT-ST10U greatly reduces its environmental impact. In Eco Standby mode, power consumption is only 0.4 W*⁵. As examples of other environmental design features, the uncoated cabinet uses no halogenated flame retardants, the lens uses lead-free glass, and an Auto Off Timer switches the projector to Standby mode when no input signal is received for a preset time. The PT-ST10U also complies with the standards of the RoHS Directive*⁶.

The Daylight View Basic Function Ensures Clear Images Even in Brightly Lit Rooms

Panasonic's Daylight View Basic technology achieves sharp, easy-to-see images by clearly reproducing the details in dark image areas, which were previously difficult to see in brightly lit rooms. A built-in sensor measures the ambient light, and the Daylight View Basic function adjusts the halftone color and brightness level according to the surrounding illumination.



Use a Whiteboard to Project Images in Classrooms with no Screens.

Projecting onto a whiteboard normally causes viewers to experience glare. However, the Panasonic Whiteboard mode reduces glare while also properly reproducing images.



Quiet 29-dB*⁷ Design Helps to Hold Viewers' Attention

The noise level is as low as 29-dB*⁷. This helps your audience to keep their attention on the discussion or on the screen images during quiet scenes.

*¹ With the lamp mode in Eco mode. This value is calculated by continuously turning the lamp on for 2 hours and off for 0.25 hour. The lamp replacement cycle will decrease if the lamp is turned on/off more frequently, or if it is left on for longer intervals. *² Fluctuations may occur in the electricity power supply except the power outage. *³ Continuing 0V power supply during several tens of milliseconds. *⁴ Power supply voltage reduction. Excluding momentary power outage. *⁵ In Eco Standby mode, network functions such as Standby On via LAN are not available, and only certain commands can be received from RS-232C control. *⁶ Restriction of the use of certain Hazardous Substances. The specified toxic substances used in the electrical and electronic equipment that is manufactured and distributed within Europe are controlled (the six substances are lead, mercury, cadmium, hexavalent chromium, polybrominated biphenyls (PBB), and polybrominated diphenyl esters (PBDE)), and all Panasonic projectors comply with the standards of the European RoHS Directive. *⁷ Lamp mode : Eco

A Wired LAN Network Function and Other Functions Allow Easy System Integration

Easy Remote Monitoring and Control Even When Mounted on the Ceiling

A Web browser on a computer connected through a wired LAN system lets you remotely operate projectors and check their status. An e-mail messaging function can also notify you when a lamp needs replacement, and indicate the overall projector status. In addition, Multi Projector Monitoring and Control Software is included for monitoring and controlling multiple Panasonic projectors from a single PC. The wired

LAN terminal is compatible with PLink™ (Class1), an open protocol that is used by many manufacturers, to enable integrated control of systems that contain different brands of projectors.



Remote operation using a Web browser

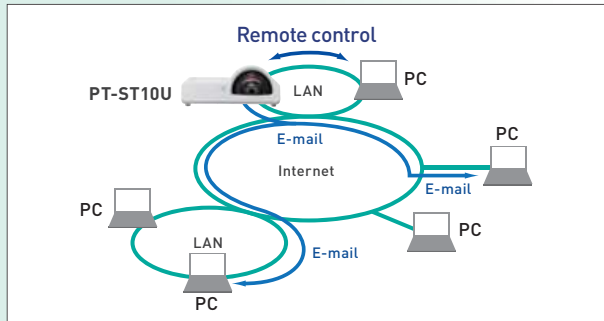

Basic concept of the Multi Projector Monitoring and Control Software

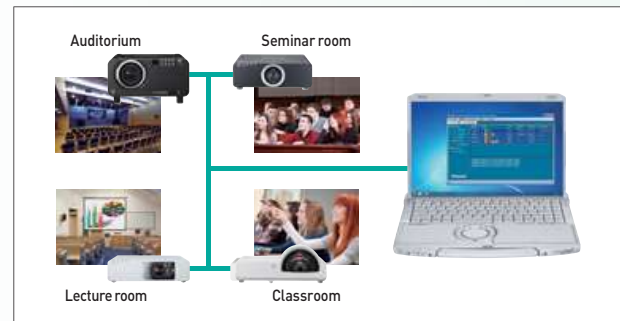

Various Interfaces Allow Use with a Wide Range of Systems

Various interfaces: Interfaces include two computer (RGB) inputs, a wired LAN terminal, and a serial (RS-232C) terminal for external control. The serial terminal has an Emulate function that lets you continue using existing control systems when replacing a previous Panasonic model. It is also possible to output audio during Standby mode. This is convenient when connecting an external audio system*8 through the projector.

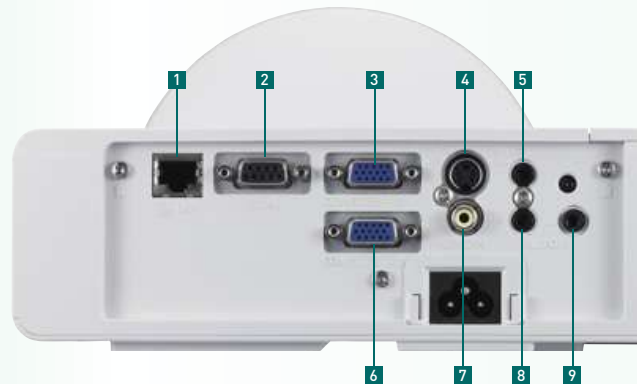

- 1 LAN
- 2 Serial input
- 3 Computer 1 input
- 4 S-Video input
- 5 Audio output
- 6 Computer 2 input
- 7 Video input
- 8 Audio 1 input
- 9 Audio 2 input

Top-Panel Lamp Replacement and Side Air Filter Replacement Simplify Maintenance Even for a Ceiling-Mounted Projector

The lamp can be accessed through the top panel for easy replacement, and the air filter can be removed and installed through the side panel. This eliminates the need to detach the projector from its ceiling bracket and greatly simplifies maintenance. The air filter uses a Micro Cut Filter, which is an electrostatic filter that employs an ion effect to attract and trap dust particles with high efficiency.



Optional Highly Durable Filter for Use in Dusty Areas

The external ET-KFB2 highly durable filter mounts to the PT-ST10U to boost dust and particle collection. This optional filter is recommended if the projector is to be installed in a dusty area.



*8 Requires speakers and an audio amplifier.

Optional Accessories



Ceiling mount bracket:
ET-PKB2



Highly durable filter unit:
ET-KFB2



Replacement air filter for ET-KFB2:
ET-RFB2



Replacement lamp unit:
ET-LAB2

Easy and Convenient to Use

A Variety of Functions Provide Easy Setup

- With Speed Start, the image quickly appears^{*9} after you press the power button.
- With Real-Time Keystone Correction, the projector automatically senses if you adjust its angle (in the vertical direction) during operation and instantly makes whatever keystone correction is necessary for optimal viewing.
- Auto Signal Search automatically detects what kind of source is connected and begins projection^{*10}.
- On-Screen Help Display: If images cannot be projected when a PC is connected by a VGA cable, this function displays the output setting method for the PC. The Help screen guides you through the button operations according to the maker of the connected PC.
- Input Guidance Function: This function displays on-screen illustrations to show the selected channel and whether the input signal is being received or not. It lets you confirm the input conditions at a glance, even when multiple devices are connected to the input terminals.

Effective Theft Prevention with the Startup Logo

You can change the default Panasonic start up logo to any logo you want. A new logo can be easily uploaded by connecting a computer to the PT-ST10U through the LAN or serial connection by using the Logo Transfer Software^{*11}. An abundance of other security measures are also included, such as a security anchor, a user password, a control panel lock, and text superimposing.



Security anchor

- *9 With the Startup Logo function turned off.
- *10 Searches for approximately 5 minutes after the power is turned on.
- *11 Uploadable still images are limited to 1024 X 768 pixel bitmap files. Also, the application will reduce the number of colors to 191.
- *12 Up to two times their original size when using video/S-Video signal input.
- *13 In Standby Eco mode, network functions such as Standby On via LAN are not available, and only certain commands can be received from RS-232C control.

Direct Power Off Function - Turn Off the Room's Main Power Immediately After Use

The Direct Power Off function keeps the cooling fan turned on even when you turn off the room's main power right after use. Electric power stored inside the unit is used to operate the cooling fan to lower the internal temperature.



Other Features

- Index Window: You can split the screen into two windows, right and left, and display a frozen (still) image in one and a real-time action image in the other.
- Digital Zoom: Expands selected parts of the display up to three times their original size^{*12}.
- Freeze Function: This function lets you display still images by freezing a motion image.
- AV mute: Temporarily turns off both the image and the sound.
- Background Color: When there is no signal from the source device, a solid background color (settable to either blue or black) is displayed on the screen to help prevent connection errors.
- A Compact, Easy-to-Use Wireless Remote Control
- Selectable 17-language on-screen menu.

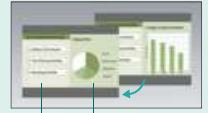

A frozen image A real-time action image



Eco Information

- No halogenated flame retardants are used in the cabinet.
- Non-coated cabinet for easy recycling.
- Daylight View Basic function makes the screen seem brighter without increasing power consumption.
- Lead-free glass is used for the lens.
- Low Standby Power Consumption of 0.4 W^{*13}.
- An Auto Off Timer switches the projector to Standby mode when no input signal is received for a preset time.



The PT-ST10U is carefully designed by Panasonic in Japan to meet demands for high quality and performance.

Related Products

Line up of the elite Panaboard applicable for the PT-ST10U

Elite Panaboard

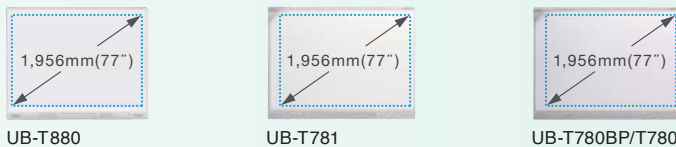

Up/Down Stand Kit



Up/Down Wall Mount Kit

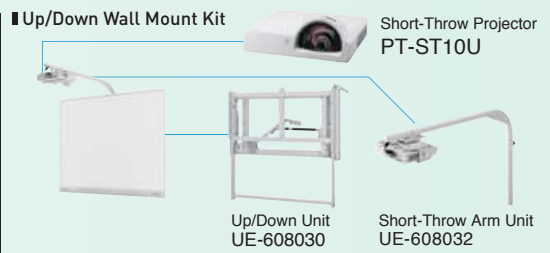

Specifications (The specifications and design are subject to change without notice as product development proceeds.)

Model		PT-ST10U	
Power supply		100-240 V AC, 50/60 Hz	
Power consumption		300W (0.4 W*1 in eco standby mode. 15 W in normal standby mode. 18 W in normal standby mode when set to audio monitor out and with fan stopped.)	
Optical system		Dichroic mirror separation/prism synthesis system	
LCD panel	Panel size	16 mm (0.63") diagonal, 4:3 aspect ratio	
	Display method	Transparent LCD panel (x 3, R/G/B)	
	Drive method	Active matrix	
	Pixels	786,432 pixels (1,024 x 768) x 3 panels	
Lens		Fixed, manual focus, F 1.80, f 6.74 mm	
Lamp		220 W UHM lamp	
Screen size (diagonal)		1.52-2.79m (60-110 inches) (4:3 aspect ratio)	
Color		Full color (16,777,216 colors)	
Brightness		2,800 lumens*2	
Center-to-corner uniformity		85%*2	
Contrast		500:1 (full on/full off)*2	
Resolution		1,024 x 768*3	
Scanning frequency	RGB	Horizontal: 15-91 kHz, Vertical: 50-85 Hz	
	YPbPr/YCbCr	480i(525i): fh 15.75 kHz; fv 60 Hz 480p(525p): fh 31.50 kHz; fv 60 Hz 720(750)/60p: fh 45.00 kHz; fv 60 Hz 1080(1125)/60i: fh 33.75 kHz; fv 60 Hz 1080(1125)/60p: fh 67.50 kHz; fv 60 Hz 576i(625i): fh 15.63 kHz; fv 50 Hz 576p(625p): fh 31.25 kHz; fv 50 Hz 720(750)/50p: fh 37.50 kHz; fv 50 Hz 1080(1125)/50i: fh 28.13 kHz; fv 50 Hz 1080(1125)/50p: fh 56.25 kHz; fv 50 Hz	
	S-Video/Video	NTSC, NTSC4.43, PAL-M, PAL60: fh 15.75 kHz; fv 60 Hz PAL, SECAM, PAL-N: fh 15.63 kHz; fv 50 Hz	
Optical axis shift		10: -0.5 (fixed)	
Keystone correction range		Vertical: ±10°	
Installation		Front/rear, ceiling/desk (menu selection)	
Built-in speaker		4cm-2cm (1-1/16"-25/32") (oval) x 1	
Terminals	COMPUTER 1 IN	D-sub HD 15-pin x 1 (RGB/YPbPr/YCbCr x 1)	
	COMPUTER 2 IN	D-sub HD 15-pin x 1 (RGB/YPbPr/YCbCr x 1)	
	VIDEO IN	RCA pin x 1 (Composite video x 1)	
	S-VIDEO IN	Mini DIN 4-pin x 1 (S-Video x 1)	
	AUDIO IN	M3 x 2 (L-R x 2)	
	VARIABLE AUDIO OUT	M3 x 1 (L-R x 1)	
	SERIAL	D-sub 9-pin x 1 (RS-232C)	
	LAN	RJ-45 x 1, compatible with PjLink™ (class 1), 100BASE-TX/10BASE-T	
Cabinet material		Moulded plastic (PC+ABS)	
Dimensions (W x H x D)		327 x 135 x 307 mm (12-7/8" x 5-1/16" x 12-3/32")*4	
Weight		Approx. 3.1 kg (6.83 lbs.)*5	
Operation environment		Temperature: 0°-40°C (32°-104°F)*6, Humidity: 20%-80% (no condensation)	
Supplied accessories		Power cord, power cord secure lock, wireless remote control, batteries for remote control (AAA type x2), VGA cable, Application software (CD-ROM), safety wire rope	

*1: In eco standby mode, network functions such as Standby On via LAN are not available, and only certain commands can be received from RS-232C control.

*2: Measurement, measuring conditions, and method of notation all comply with ISO 21118 international standards.

*3: Input signals that exceed this resolution will be converted to 1,024 x 768 pixels.

*4: Protruding parts not included.

*5: Average value (excluding lens cap). May differ depending on models.

*6: The operating temperature range is 0°C (32°F) to 35°C (95°F) when used in High-Altitude mode (1,400 to 2,700 m (4,593 to 8,858 feet)).

Also, in Lamp Normal mode, if the ambient temperature exceeds 35°C/95°F (30°C/85°F in High-Altitude mode), the light output may be reduced approximately 30% to protect the projector.

Dimensions

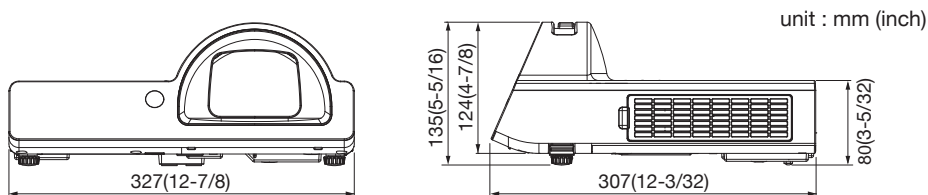

Projection Distance (Screen aspect ratio = 4:3)

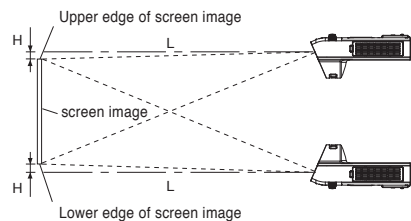

PT-ST10U (Screen aspect ratio = 4:3)

Project size (diagonal)	Projection distance (L)	Height from the edge of screen to center of lens (H)
1.52 m (60")	0.60 m (1.97')	-0.05 m (-0.5')
1.78 m (70")	0.71 m (2.33')	-0.05 m (-0.6')
2.03 m (80")	0.82 m (2.69')	-0.06 m (-0.7')
2.29 m (90")	0.92 m (3.02')	-0.07 m (-0.8')
2.54 m (100")	1.03 m (3.38')	-0.08 m (-0.8')
2.79 m (110")	1.14 m (3.74')	-0.08 m (-0.9')

Panasonic®

For more information about Panasonic projectors
<http://panasonic.net/avc/projector>

