

SANYO

Multimedia Projector

MODEL PLV-75/PLV-80

PLV75L/PLV-80L (Lensless)

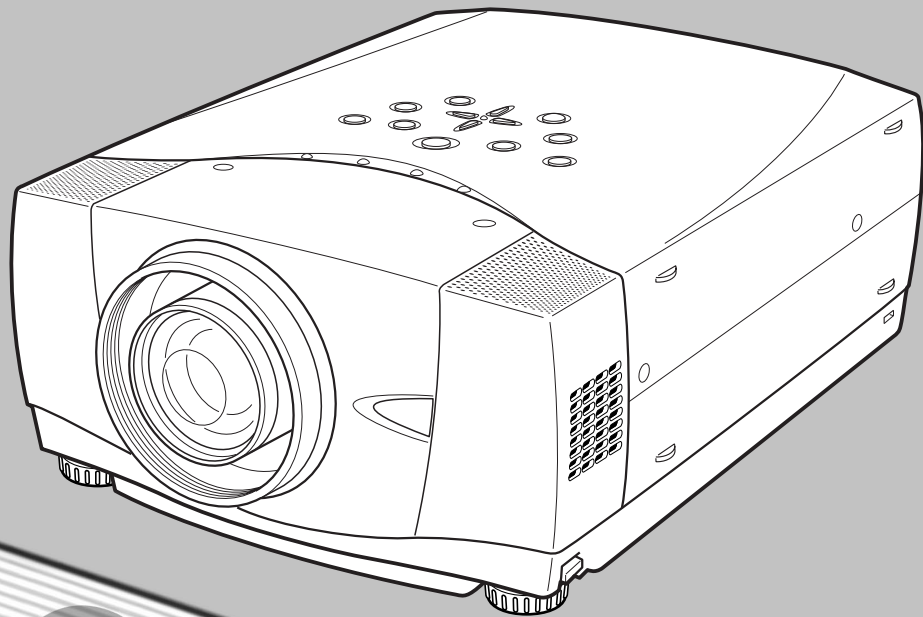

PROJECTOR

Owner's Manual

Link™





TO THE OWNER

Before operating this projector, read this manual thoroughly and operate the projector properly.



This projector provides many convenient features and functions. Operating the projector properly enables you to manage those features and maintain it in better condition for a considerable time.

Improper operation may result in not only shortening the product life, but also malfunctions, fire hazard, or other accidents.

If your projector seems to operate improperly, read this manual again, check operations and cable connections and try the solutions in the "Troubleshooting" section in the end of this booklet. If the problem still persists, contact the dealer where you purchased the projector or the service center.

 CAUTION RISK OF ELECTRIC SHOCK DO NOT OPEN 
CAUTION : TO REDUCE THE RISK OF ELECTRIC SHOCK, DO NOT REMOVE COVER (OR BACK). NO USER-SERVICEABLE PARTS INSIDE EXCEPT LAMP REPLACEMENT. REFER SERVICING TO QUALIFIED SERVICE PERSONNEL.
 THIS SYMBOL INDICATES THAT DANGEROUS VOLTAGE CONSTITUTING A RISK OF ELECTRIC SHOCK IS PRESENT WITHIN THIS UNIT.
 THIS SYMBOL INDICATES THAT THERE ARE IMPORTANT OPERATING AND MAINTENANCE INSTRUCTIONS IN THE OWNER'S MANUAL WITH THIS UNIT.

NOTE: This symbol mark and recycle system are applied only to EU countries and not applied to the countries in the other area of the world.

	Your SANYO product is designed and manufactured with high quality materials and components which can be recycled and reused.
	This symbol means that electrical and electronic equipment, at their end-of-life, should be disposed of separately from your household waste.

Please dispose of this equipment at your local community waste collection/recycling centre.
In the European Union there are separate collection systems for used electrical and electronic products.
Please help us to conserve the environment we live in!

Safety Precaution

WARNING : TO REDUCE THE RISK OF FIRE OR ELECTRIC SHOCK, DO NOT EXPOSE THIS APPLIANCE TO RAIN OR MOISTURE.

- This projector produces intense light from the projection lens. Do not stare directly into the lens as much as possible. Eye damage could result. Be especially careful that children do not stare directly into the beam.
- Install the projector in a proper position. If not, it may result in a fire hazard.
- Provide appropriate space on the top, sides and rear of the projector cabinet for allowing air circulation and cooling the projector. Minimum clearances must be maintained. If the projector is to be built into a compartment or similarly enclosed, the minimum distances must be maintained. Do not cover the ventilation slot on the projector. Heat build-up can reduce the service life of your projector, and can also be dangerous.

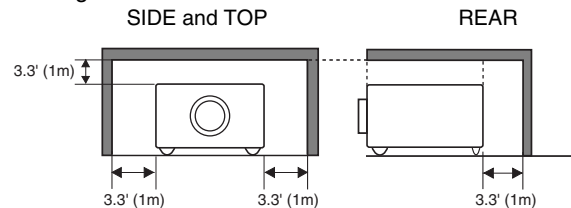

- If the projector is not to be used for an extended time, unplug the projector from the power outlet.

CAUTION ON HANGING FROM THE CEILING

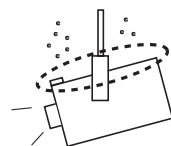

When hanging the projector from the ceiling, clean the air intake vents, air filters, and top of the projector periodically with a vacuum cleaner. If you leave the projector without cleaning for a long time, the dust will block the operation of the cooling function, and it may cause a breakdown or a disaster.

DO NOT SET THE PROJECTOR IN GREASY, WET, OR SMOKY CONDITIONS SUCH AS IN A KITCHEN TO PREVENT A BREAKDOWN OR A DISASTER. IF THE PROJECTOR COMES IN CONTACT WITH OIL OR CHEMICALS, IT MAY BECOME DETERIORATED.

CAUTION

Not for use in a computer room as defined in the Standard for the Protection of Electronic Computer/Data Processing Equipment, ANSI/NFPA 75.

Ne peut être utilisé dans une salle d'ordinateurs telle que définie dans la norme ANSI/NFPA 75 Standard for Protection of Electronic Computer/Data Processing Equipment.

READ AND KEEP THIS OWNER'S MANUAL FOR LATER USE.

SAFETY INSTRUCTIONS

All the safety and operating instructions should be read before the product is operated.

Read all of the instructions given here and retain them for later use. Unplug this projector from AC power supply before cleaning. Do not use liquid or aerosol cleaners. Use a damp cloth for cleaning.

Follow all warnings and instructions marked on the projector.

For added protection to the projector during a lightning storm, or when it is left unattended and unused for long periods of time, unplug it from the wall outlet. This will prevent damage due to lightning and power line surges.

Do not expose this unit to rain or use near water... for example, in a wet basement, near a swimming pool, etc...

Do not use attachments not recommended by the manufacturer as they may cause hazards.

Do not place this projector on an unstable cart, stand, or table. The projector may fall, causing serious injury to a child or adult, and serious damage to the projector. Use only with a cart or stand recommended by the manufacturer, or sold with the projector. Wall or shelf mounting should follow the manufacturer's instructions, and should use a mounting kit approved by the manufacturers.

An appliance and cart combination should be moved with care. Quick stops, excessive force, and uneven surfaces may cause the appliance and cart combination to overturn.



Slots and openings in the back and bottom of the cabinet are provided for ventilation, to insure reliable operation of the equipment and to protect it from overheating.

The openings should never be covered with cloth or other materials, and the bottom opening should not be blocked by placing the projector on a bed, sofa, rug, or other similar surface. This projector should never be placed near or over a radiator or heat register.

This projector should not be placed in a built-in installation such as a book case unless proper ventilation is provided.

Never push objects of any kind into this projector through cabinet slots as they may touch dangerous voltage points or short out parts that could result in a fire or electric shock. Never spill liquid of any kind on the projector.

Do not install the projector near the ventilation duct of air-conditioning equipment.

This projector should be operated only from the type of power source indicated on the marking label. If you are not sure of the type of power supplied, consult your authorized dealer or local power company.

Do not overload wall outlets and extension cords as this can result in fire or electric shock. Do not allow anything to rest on the power cord. Do not locate this projector where the cord may be damaged by persons walking on it.

Do not attempt to service this projector yourself as opening or removing covers may expose you to dangerous voltage or other hazards. Refer all servicing to qualified service personnel.

Unplug this projector from wall outlet and refer servicing to qualified service personnel under the following conditions:

- a. When the power cord or plug is damaged or frayed.
- b. If liquid has been spilled into the projector.
- c. If the projector has been exposed to rain or water.
- d. If the projector does not operate normally by following the operating instructions. Adjust only those controls that are covered by the operating instructions as improper adjustment of other controls may result in damage and will often require extensive work by a qualified technician to restore the projector to normal operation.
- e. If the projector has been dropped or the cabinet has been damaged.
- f. When the projector exhibits a distinct change in performance-this indicates a need for service.

When replacement parts are required, be sure the service technician has used replacement parts specified by the manufacturer that have the same characteristics as the original part. Unauthorized substitutions may result in fire, electric shock, or injury to persons.

Upon completion of any service or repairs to this projector, ask the service technician to perform routine safety checks to determine that the projector is in safe operating condition.

Voor de klanten in Nederland



Bij dit product zijn batterijen geleverd. Wanneer deze leeg zijn, moet u ze niet weggooien maar inleveren als KCA.

COMPLIANCES

Federal Communication Commission Notice

Note : This equipment has been tested and found to comply with the limits for a Class B digital device, pursuant to part 15 of the FCC Rules. These limits are designed to provide reasonable protection against harmful interference in a residential installation. This equipment generates, uses and can radiate radio frequency energy and, if not installed and used in accordance with the instructions, may cause harmful interference to radio communications. However, there is no guarantee that interference will not occur in a particular installation. If this equipment does cause harmful interference to radio or television reception, which can be determined by turning the equipment off and on, the user is encouraged to try to correct the interference by one or more of the following measures :

- Reorient or relocate the receiving antenna.
- Increase the separation between the equipment and receiver.
- Connect the equipment into an outlet on a circuit different from that to which the receiver is connected.
- Consult the dealer or an experienced radio/TV technician for help.

Use of shielded cable is required to comply with class B limits in Subpart B of Part 15 of FCC Rules.

Do not make any changes or modifications to the equipment unless otherwise specified in the instructions. If such changes or modifications should be made, you could be required to stop operation of the equipment.

Model Number : PLV-75/PLV-80/PLV-75L/PLV-80L
Trade Name : Sanyo
Responsible party : SANYO FISHER COMPANY
Address : 21605 Plummer Street, Chatsworth, California 91311
Telephone No. : (818)998-7322

AC POWER CORD REQUIREMENT

The AC Power Cord supplied with this projector meets the requirement for use in the country you purchased it.

AC Power Cord for the United States and Canada :

AC Power Cord used in the United States and Canada is listed by the Underwriters Laboratories (UL) and certified by the Canadian Standard Association (CSA).

AC Power Cord has a grounding-type AC line plug. This is a safety feature to be sure that the plug will fit into the power outlet. Do not try to defeat this safety feature. Should you be unable to insert the plug into the outlet, contact your electrician.

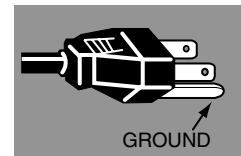

AC Power Cord for the United Kingdom :

This cord is already fitted with a moulded plug incorporating a fuse, the value of which is indicated on the pin face of the plug. Should the fuse need to be replaced, an ASTA approved BS 1362 fuse must be used of the same rating, marked thus \diamond . If the fuse cover is detachable, never use the plug with the cover omitted. If a replacement fuse cover is required, ensure it is of the same colour as that visible on the pin face of the plug (i.e. red or orange). Fuse covers are available from the Parts Department indicated in your User Instructions.

If the plug supplied is not suitable for your socket outlet, it should be cut off and destroyed.

The end of the flexible cord should be suitably prepared and the correct plug fitted. (See Over)

WARNING : A PLUG WITH BARED FLEXIBLE CORD IS HAZARDOUS IF ENGAGED IN A LIVE SOCKET OUTLET.

The Wires in this mains lead are coloured in accordance with the following code:

Green-and-yellow Earth
Blue Neutral
Brown Live

As the colours of the wires in the mains lead of this apparatus may not correspond with the coloured markings identifying the terminals in your plug proceed as follows:

The wire which is coloured green-and-yellow must be connected to the terminal in the plug which is marked by the letter E or by the safety earth symbol \perp or coloured green or green-and-yellow.

The wire which is coloured blue must be connected to the terminal which is marked with the letter N or coloured black.

The wire which is coloured brown must be connected to the terminal which is marked with the letter L or coloured red.

WARNING : THIS APPARATUS MUST BE EARTHED.

THE SOCKET-OUTLET SHOULD BE INSTALLED NEAR THE EQUIPMENT AND EASILY ACCESSIBLE.

TABLE OF CONTENTS

FEATURES AND DESIGN	6	COMPUTER INPUT	24
PREPARATION	7	SELECTING INPUT SOURCE	24
NAME OF EACH PART OF PROJECTOR	7	SELECTING COMPUTER SYSTEM	24
SETTING-UP PROJECTOR	8	PC ADJUSTMENT	26
CONNECTING AC POWER CORD	8	AUTO PC ADJUSTMENT	26
POSITIONING PROJECTOR	9	MANUAL PC ADJUSTMENT	27
LENS INSTALLATION	9	PICTURE IMAGE SELECT	29
ADJUSTABLE FEET	10	IMAGE LEVEL SELECT	29
INSTALLING PROJECTOR IN PROPER POSITION	10	PICTURE SCREEN ADJUSTMENT	30
MOVING PROJECTOR	11	PICTURE SCREEN SELECT	30
CONNECTING PROJECTOR	12	VIDEO INPUT	31
TERMINALS OF PROJECTOR	12	SELECTING INPUT SOURCE	31
CONNECTING TO COMPUTER	13	SELECTING VIDEO SYSTEM	32
CONNECTING TO VIDEO EQUIPMENT	14	PICTURE IMAGE SELECT	33
		IMAGE LEVEL SELECT	33
		PICTURE SCREEN ADJUSTMENT	34
		PICTURE SCREEN SELECT	34
BEFORE OPERATION	15	PICTURE IMAGE	35
OPERATION OF REMOTE CONTROL	15	PICTURE IMAGE ADJUSTMENTS	35
REMOTE CONTROL BATTERIES INSTALLATION	16	SETTING	38
TOP CONTROLS AND INDICATORS	17	SETTING MENU	38
OPERATING ON-SCREEN MENU	18	APPENDIX	44
HOW TO OPERATE ON-SCREEN MENU	18	MAINTENANCE	44
FLOW OF ON-SCREEN MENU OPERATION	18	WARNING TEMP. INDICATOR	44
MENU BAR	19	AIR FILTER CARE AND CLEANING	45
		CLEANING PROJECTION LENS	45
		LAMP REPLACEMENT	46
		LAMP REPLACE COUNTER	47
		TROUBLESHOOTING	48
		MENU TREE	50
		COMPATIBLE COMPUTER SPECIFICATIONS	52
		INDICATORS AND PROJECTOR CONDITION	53
		TECHNICAL SPECIFICATIONS	55
		PJ LINK NOTICE	56
		CONFIGURATIONS OF TERMINALS	57
		OPTIONAL PARTS	58
		LENS REPLACEMENT	58
		PIN CODE NUMBER MEMO	59
BASIC OPERATION	20		
TURNING ON / OFF PROJECTOR	20		
TURNING ON THE PROJECTOR	20		
TURNING OFF THE PROJECTOR	21		
ADJUSTING SCREEN	22		
ZOOM ADJUSTMENT	22		
FOCUS ADJUSTMENT	22		
LENS SHIFT ADJUSTMENT	22		
KEystone ADJUSTMENT	22		
PICTURE FREEZE FUNCTION	23		
NO SHOW FUNCTION	23		
SOUND ADJUSTMENT	23		

TRADEMARKS

- Apple, Macintosh, and PowerBook are trademarks or registered trademarks of Apple Computer, Inc.
- IBM and PS/2 are trademarks or registered trademarks of International Business Machines, Inc.
- Windows and PowerPoint are registered trademarks of Microsoft Corporation.
- Each name of corporations or products in the owner's manual is a trademark or a registered trademark of its respective corporation.

FEATURES AND DESIGN

This Multimedia Projector is designed with most advanced technology for portability, durability, and ease of use. This projector utilizes built-in multimedia features, a palette of 16.77 million colors, and matrix liquid crystal display (LCD) technology.

◆ Compact Design

This projector is extremely compact in size and weight. It is designed to carry and work anywhere you wish to use.

◆ Compatibility

This projector widely accepts various video and computer input signals including;

● Computers

IBM-compatible or Macintosh computer up to 1600 x 1200 resolution.

● 6 Color Systems

NTSC, PAL, SECAM, NTSC 4.43, PAL-M or PAL-N color system can be connected.

● Component Video

Component video signal, such as a DVD player output high definition TV signals including 480i, 480p, 575i, 575p, 720p, 1035i or 1080i, can be connected.

● S-Video

S-Video signal, such as a S-VHS VCR output signal, can be connected.

◆ High Resolution Image

This projector provides 1366 x 768 dots resolution for computer input and 800 horizontal TV lines. Resolution from a computer between XGA (1024 x 768) and UXGA (1600 x 1200) is compressed into 1024 x 768 dots. This projector cannot display image of over 1600 x 1200 dots. When resolution of your computer is over than 1600 x 1200, reset a computer output for lower resolution.

◆ Multi-Scan System

This projector has Multi-Scan System to conform to almost all computer output signals quickly. There is no need for troublesome manual adjustment of frequency and other settings.

◆ One-Touch Auto PC Adjustment

Incoming computer video signals are recognized and best adjustment is automatically set by Auto PC Adjustment. No complicated setup is necessary and projection is always precise.

◆ Motor-driven Lens Shift

Projection lens can be moved up and down with motor-driven lens shift function. This function makes it easy to provide projected image where you want. Zoom and focus can be also adjusted with motor-driven operation.

◆ Digital Zoom (for Computer)

Digital Zoom function adjusts image size to approx. 1/4 ~ 49 times of original image size, allowing you to focus on crucial information at a presentation.

◆ Keystone Correction

Positioning of a projector may result in distorted image being displayed in a trapezoid shape. Keystone Correction solves this problem by digitally altering projection to produce undistorted images.

◆ Power Management

Power Management function is provided to reduce power consumption while a projector is not in use.

This Power Management function operates to turn Projection Lamp off when a projector detects signal interruption and any button is not pressed. Projection Lamp is automatically turned on again when a projector detects signal or any operation button is pressed.

This projector is shipped with this function ON.

◆ Digital Visual Interface

This projector is equipped with DVI 24-pin terminal for connecting DVI output from a computer.

◆ Color management

You can make fine adjustments to the colors on the screen to change them to the desired colors.

At this time, the colors are changed within an extremely narrow hue range, so that other colors are not affected. The luminance and gamma values can also be changed in addition to the hue.

This allows colors to be reproduced with great accuracy. Faithful color reproduction and color correction which effectively matches colors to scenes or emphasizes colors can be achieved.

Adjustments can be made easily, because they are reflected in the on-screen images in real time. Up to eight colors can be adjusted at a single time. The adjustment data can be saved for images in both in video mode and PC mode (total 20 images). The adjusted data is displayed in a list for easy checking.

◆ Auto Picture Control

The gamma value can be adjusted automatically in accordance with the luminance of the screen. Images that are either too dark or too bright can be adjusted to the optimum level, so that these images can be reproduced without any distortion.

Equipped with an advanced Intelligent Digital Sharpness Control which controls the sharpness automatically in accordance with the images on the screen.

◆ Multilanguage Menu Display

Operation menu is displayed in; English, German, French, Italian, Spanish, Portuguese, Dutch, Swedish, Russian, Chinese, Korean or Japanese.

◆ PJ-Net Organizer (Optional)

PJ-Net Organizer enables the projector to display the image of the computer screen and the data image stored in the computer via a network. The projector can be also controlled and maintained through a web browser.

PREPARATION

NAME OF EACH PART OF PROJECTOR

FRONT OF CABINET

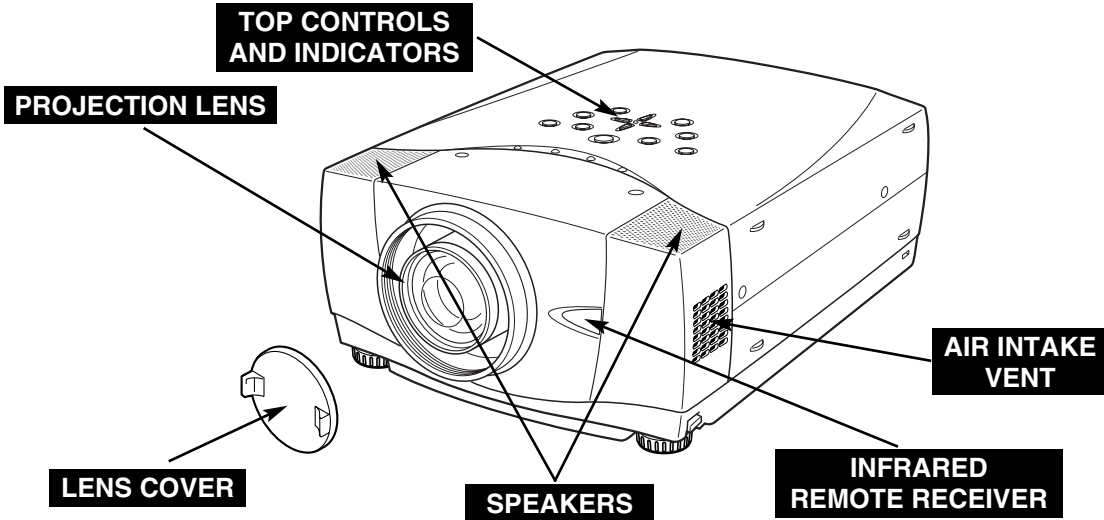

BACK OF CABINET

EXHAUST VENT



HOT AIR EXHAUSTED !

Air blown from exhaust vent is hot. When using or installing a projector, following precautions should be taken.

- Do not put a flammable object near this vent.
- Keep rear grills at least 3.3'(1 m) away from any object, especially heat-sensitive object.
- Do not touch this area, especially screws and metallic parts. This area will become hot while a projector is used.

This projector detects internal temperature and automatically controls operating power of Cooling Fans.

POWER CORD CONNECTOR

TERMINALS AND CONNECTORS

INFRARED REMOTE RECEIVER

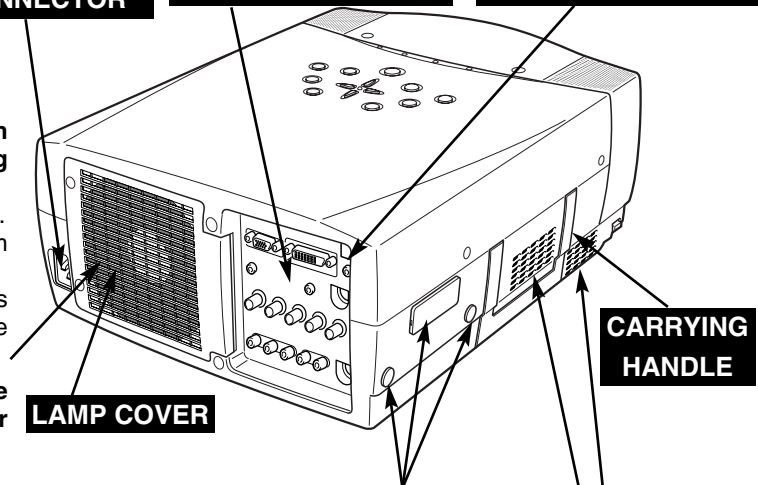

When attached the PJ-Net organizer (optional part) to the projector, remove the these parts. Refer to the owner's manual in the optional PJ-Net organizer.

BOTTOM OF CABINET

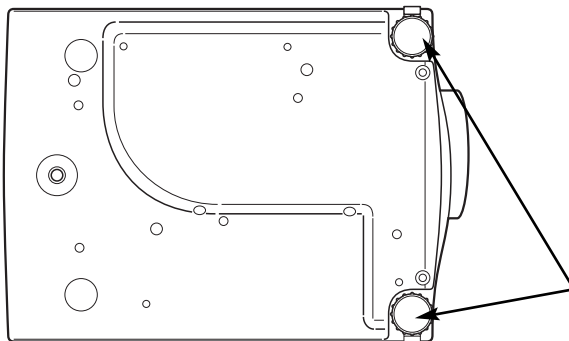

AIR INTAKE VENTS

This projector is equipped with cooling fans for protection from overheating. Pay attention to following to ensure proper ventilation and avoid a possible risk of fire and malfunction.

- Do not cover vent slots.
- Keep side clear of any objects. Obstructions may block cooling air.

ADJUSTABLE FEET AND FEET LOCK LATCHES

SETTING-UP PROJECTOR

CONNECTING AC POWER CORD

This projector uses nominal input voltages of 100-120 V or 200-240 V AC. This projector automatically selects correct input voltage. It is designed to work with single-phase power systems having a grounded neutral conductor. To reduce risk of electrical shock, do not plug into any other type of power system. Consult your authorized dealer or service station if you are not sure of type of power supply being in use. Connect a projector with a peripheral equipment before turning a projector on. (Refer to pages 12 ~ 14 for connection.)

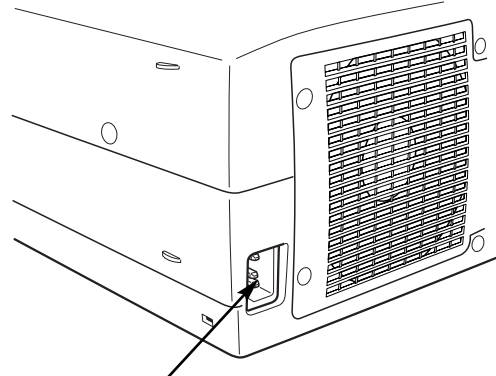

Connect AC Power Cord (supplied) to a projector. AC outlet must be near this equipment and must be easily accessible.



CAUTION

For safety, unplug AC Power Cord when an appliance is not used. When this projector is connected to outlet with AC Power Cord, an appliance is in Stand-by Mode and consumes a little electric power.

NOTE ON POWER CORD

AC Power Cord must meet requirement of country where you use a projector. Confirm an AC plug type with chart below and proper AC Power Cord must be used. If supplied AC Power Cord does not match your AC outlet, contact your sales dealer.

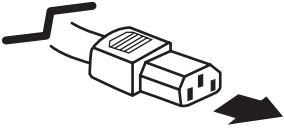
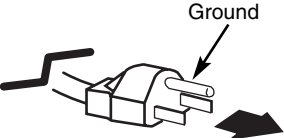
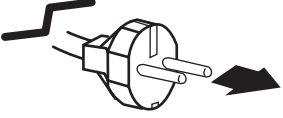
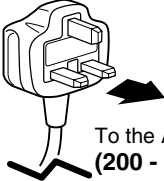
Projector side	AC Outlet side		
 <p data-bbox="240 1373 456 1444">To POWER CORD CONNECTOR on your projector.</p>	<p data-bbox="493 1171 797 1199">For the U.S.A. and Canada</p>  <p data-bbox="623 1381 792 1434">To the AC Outlet. (120 V AC)</p>	<p data-bbox="829 1171 1122 1199">For Continental Europe</p>  <p data-bbox="948 1394 1133 1446">To the AC Outlet. (200 - 240 V AC)</p>	<p data-bbox="1230 1171 1382 1199">For the U.K.</p>  <p data-bbox="1279 1373 1464 1425">To the AC Outlet. (200 - 240 V AC)</p>

POSITIONING PROJECTOR

- This projector is designed to project on a flat projection surface.
- Projector can be focused from 5.0' (1.5m) ~ 52.2' (15.9m).
- Refer to figure below to adjust screen size.

ROOM LIGHT

Brightness in room has a great influence on picture quality. It is recommended to limit ambient lighting in order to provide best image.

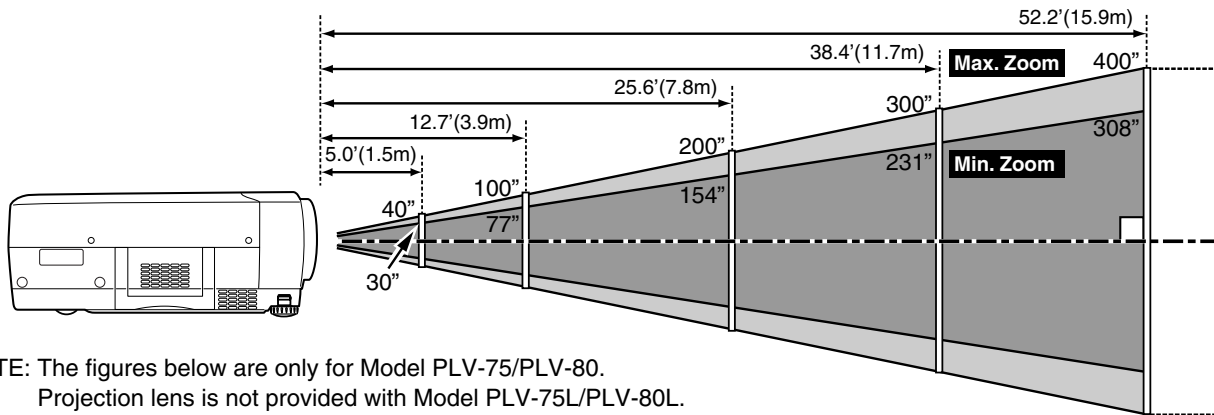

NOTE: The figures below are only for Model PLV-75/PLV-80.
Projection lens is not provided with Model PLV-75L/PLV-80L.

Screen Size	Max. Zoom	40"	100"	150"	200"	250"	300"	400"
	Min. Zoom	30"	77"	115"	154"	192"	231"	308"
Distance		5.0' (1.5m)	12.7' (3.9m)	19.1' (5.8m)	25.6' (7.8m)	32.0' (9.8m)	38.4' (11.7m)	52.2' (15.9m)

LENS SHIFT ADJUSTMENT

Projection lens can be moved up and down with motor-driven lens shift function. This function makes it easy to provide projected image where you want. Refer to P 22 for operation.

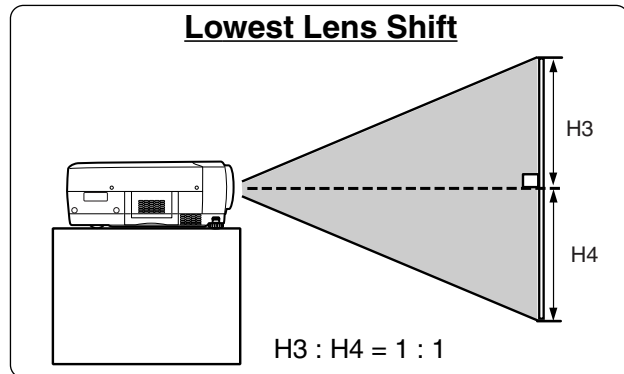
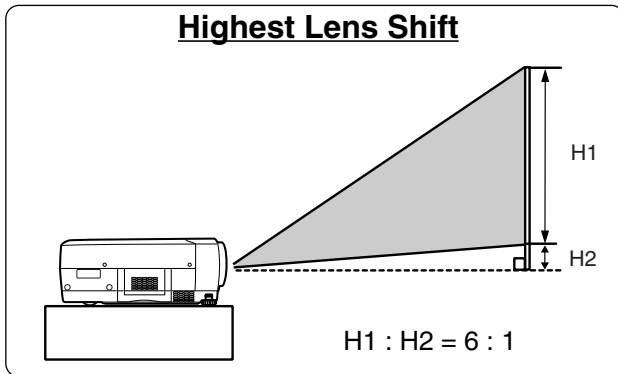

NOTE

Screen size and lens shift ratio on the above charts are standard values and they may change by positioning conditions.

LENS INSTALLATION (For Lensless model PLV-75L/PLV-80L only)

Before setting up a projector, install Projection Lens on Projector.

1. Before installation, check where a projector is used and prepare suitable lens. For specifications of a Projection Lens, contact sales dealer where you purchased a projector.
2. For installation, refer to installation manual in the optional lens.

NOTE;

When install the lens, remove the cover cap in the projector.

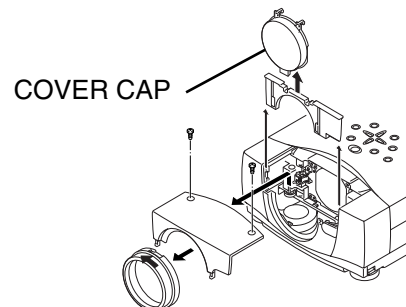

PREPARATION

ADJUSTABLE FEET

Picture tilt and projection angle can be adjusted by rotating ADJUSTABLE FEET. Projection angle can be adjusted to 10.5 degrees.

- 1** Lift front of a projector and pull FEET LOCK LATCHES on both sides of a projector.
- 2** Release FEET LOCK LATCHES to lock ADJUSTABLE FEET and rotate ADJUSTABLE FEET to fine tune position and tilt.
- 3** To shorten ADJUSTABLE FEET, lift front of a projector and pull and undo FEET LOCK LATCHES.

Position and keystone distortion of image can be adjusted using Menu Operation. (Refer to P 22 and 38.)

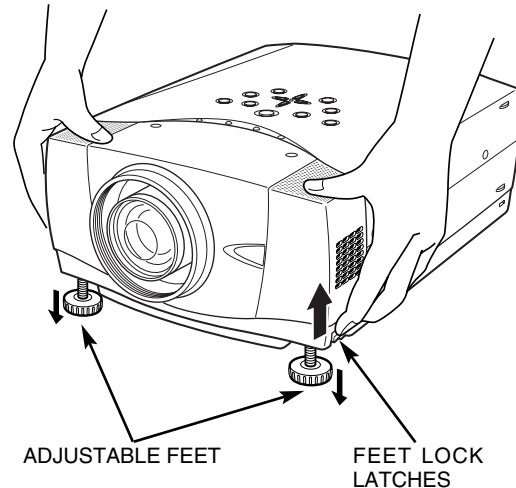

INSTALLING PROJECTOR IN PROPER POSITION

Install the projector properly. Improper installation may reduce the lamp lifetime and cause a fire hazard.

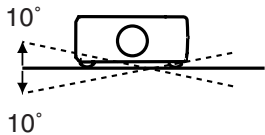

Do not tilt the projector more than 10 degrees above and below.



NO UPWARD

Do not point the projector up to project an image.



NO DOWNWARD

Do not point the projector down to project an image.



NO SIDEWAYS

Do not put the projector on either side to project an image.

MOVING PROJECTOR

Use Carrying Handle when moving a Projector.
When moving a projector, replace lens cover and retract feet to prevent damage to lens and cabinet.
When this projector is not in use for an extended period, put it into case (not supplied with this projector).

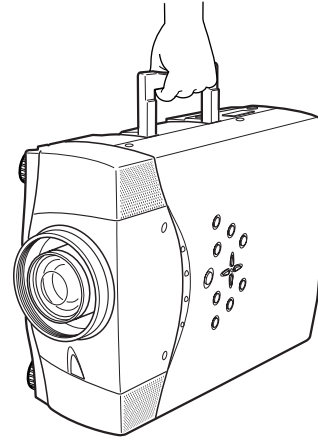

CAUTION IN CARRYING OR TRANSPORTING A PROJECTOR

- Do not drop or bump a projector, otherwise damages or malfunctions may result.
- When carrying a projector, use a suitable carrying case.
- Do not transport a projector by using a courier or transport service in an unsuitable transport case. This may cause damage to a projector. To transport a projector through a courier or transport service, consult your dealer for best way.

CONNECTING PROJECTOR

TERMINALS OF PROJECTOR

This projector has input and output terminals on its back for connecting computers and video equipment. Refer to figures on pages 12 to 14 and connect properly.

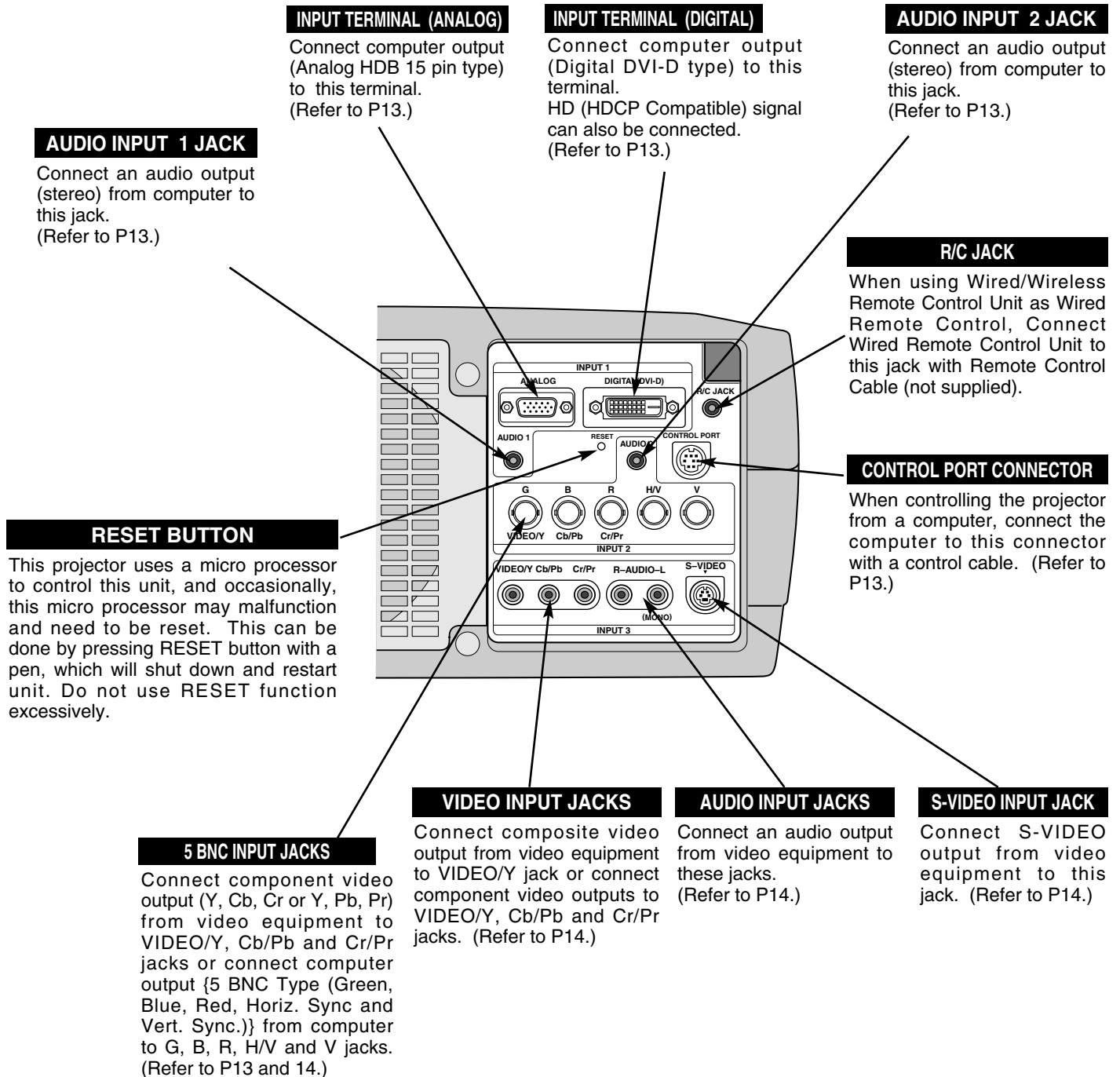

CONNECTING TO COMPUTER

Cables used for connection (* = Cable or adapter is not supplied with this projector.)

- VGA Cable (HDB 15 pin) *
- DVI-Digital Cable (for Single Link T.M.D.S.) *
- BNC Cable *
- Control Cable for Serial Port
- Audio Cables (Mini Plug (stereo)) *

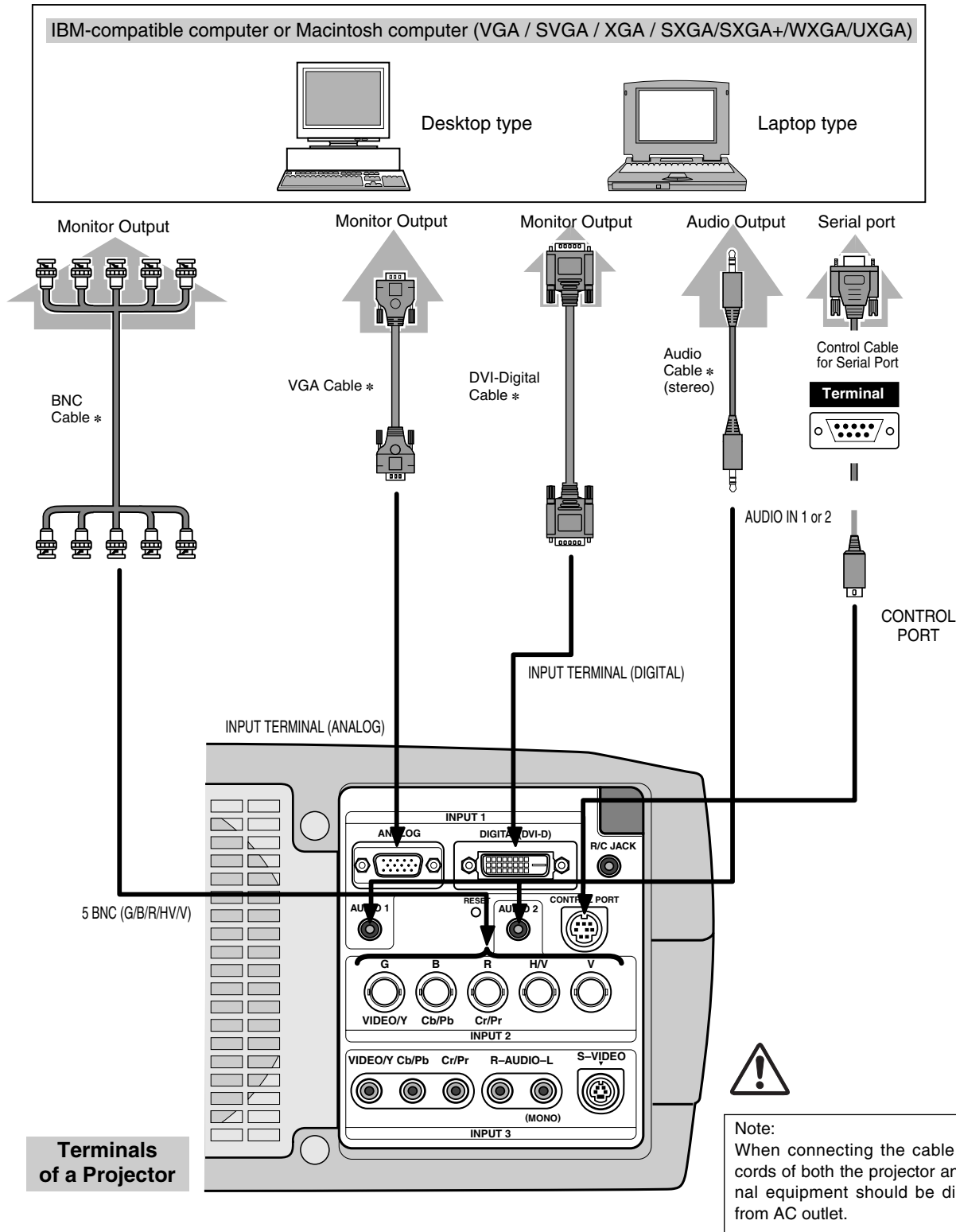

CONNECTING TO VIDEO EQUIPMENT

Cables used for connection (* = Cable is not supplied with this projector.)

- Video Cable (RCA x 1 or RCA x 3) *
- BNC Cable *
- S-VIDEO Cable *
- DVI-Digital Cable (for Single Link T.M.D.S.) *
- Audio Cable (RCA x 2) *
- HDB 15 pin-SCART 21 pin Cable *

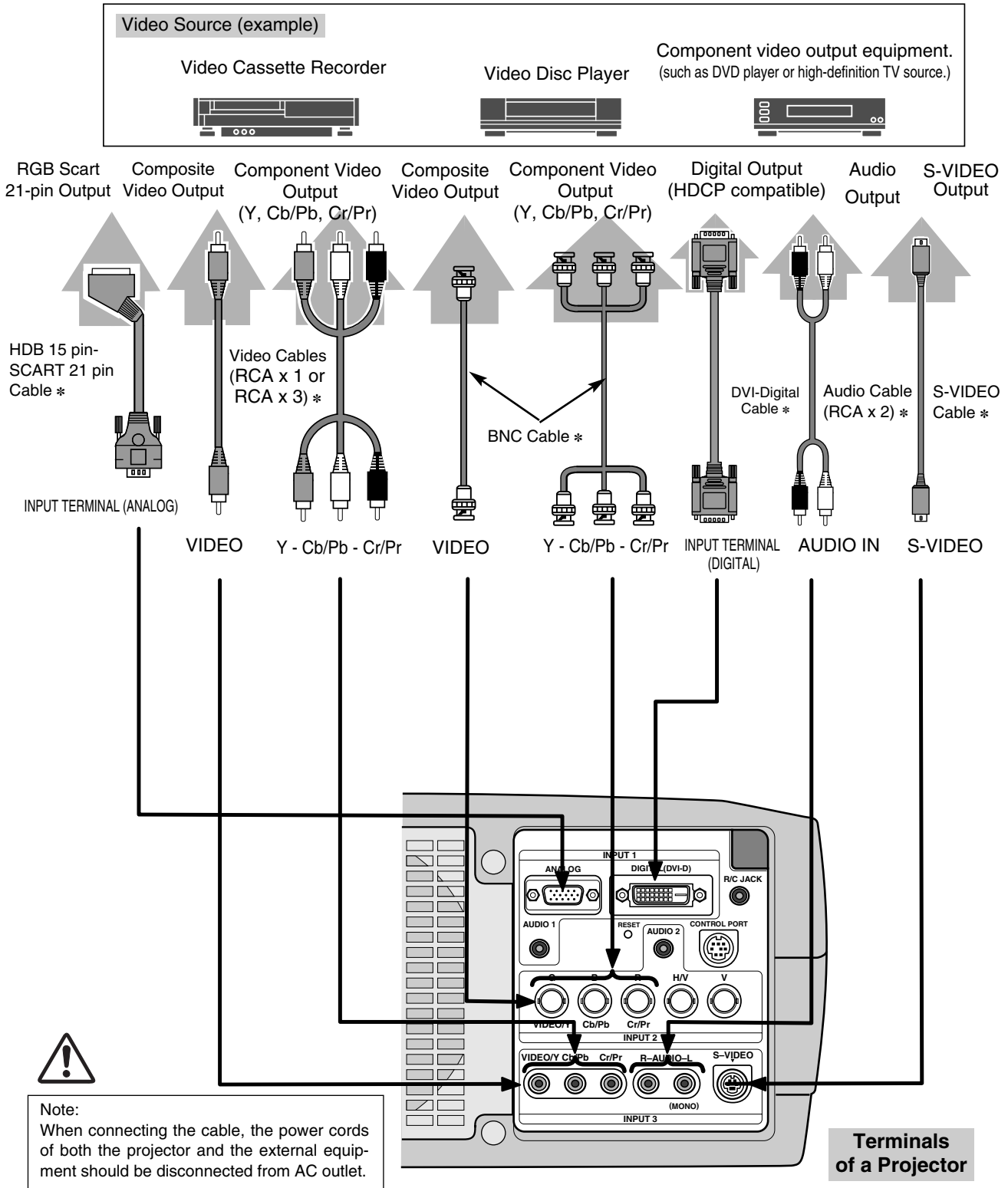

BEFORE OPERATION

OPERATION OF REMOTE CONTROL

LIGHT BUTTON

Lights the buttons on the remote control for about 10 seconds.

AUTO PC ADJ. BUTTON

Used to operate AUTO PC Adjustment function. (P26)

POWER ON-OFF BUTTON

Used to turn projector on or off. (P20, 21)

MENU BUTTON

Used to select MENU operation. (P18, 19)

COLOR M. BUTTON

Used to operate COLOR MANAGEMENT. (P35, 36)

POINT (UP / DOWN / LEFT / RIGHT) BUTTONS

Used to select an item or adjust value in ON-SCREEN MENU. They are also used to pan image in DIGITAL ZOOM +/- mode. (P30)
POINT LEFT/RIGHT buttons are also used as VOLUME +/- buttons. (P23)

SELECT BUTTON

Used to execute item selected. It is also used to expand / compress image in DIGITAL ZOOM mode. (P30)

IMAGE ADJ. BUTTON

Used to adjust image level. (P35-37)

INPUT BUTTON

Used to select input source. (P24, 31)

IMAGE BUTTON

Used to select image level. (P29, 33)

D.ZOOM BUTTON

Used to select DIGITAL ZOOM +/- mode and resize image. (P30)

NO SHOW BUTTON

Used to turn picture into black image. (P23)

FREEZE BUTTON

Used to freeze picture. (P23)

SCREEN BUTTON

Used to select screen. (P30, 34)

MUTE BUTTON

Used to mute sound. (P23)

LENS SHIFT BUTTON

Used to select LENS SHIFT function. (P22)

KEystone BUTTON

Used to correct keystone distortion. (P22, 38)

ZOOM BUTTON

Used to adjust zoom. (P22)

WIRED REMOTE JACK

When using as Wired Remote Control, connect Remote Control Cable to this jack. Battery installation is required when using as Wired Remote Control.

FOCUS BUTTON

Used to adjust focus. (P22)

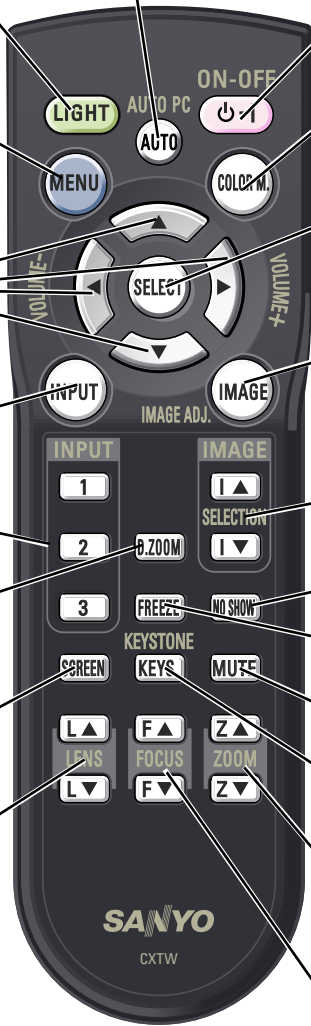

REMOTE CONTROL BATTERIES INSTALLATION

1 Remove battery compartment lid.

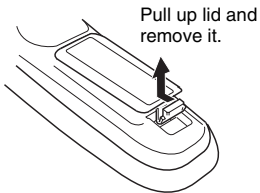

2 Slide batteries into compartment.

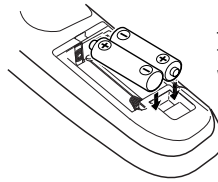

Two AA size batteries
For correct polarity (+ and -), be sure battery terminals are in contact with pins in compartment.

3 Replace compartment lid.

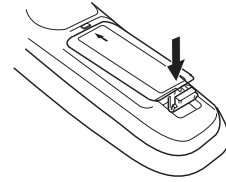

To insure safe operation, please observe following precautions :

- Use (2) AA, UM3 or R06 type alkaline batteries.
- Replace two batteries at same time.
- Do not use a new battery with an used battery.
- Avoid contact with water or liquid.
- Do not expose Remote Control Unit to moisture, or heat.
- Do not drop Remote Control Unit.
- If a battery has leaked on Remote Control Unit, carefully wipe case clean and install new batteries.
- Danger of explosion if battery is incorrectly replaced.
- Dispose of used batteries according to batteries manufacturers instructions and local rules.

Operating Range

Point Remote Control Unit toward projector (Infrared Remote Receiver) whenever pressing any button. Maximum operating range for Remote Control Unit is about 16.4' (5m) and 60° in front and rear of a projector.

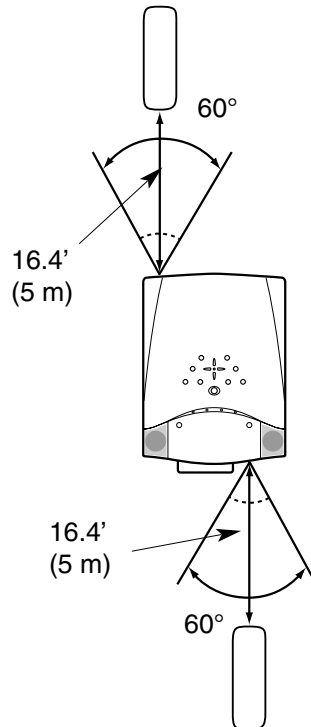

TOP CONTROLS AND INDICATORS

This projector has CONTROL BUTTONS (TOP CONTROLS) and INDICATORS on its top.

LAMP REPLACE INDICATOR

Turns to yellow when life of projection lamp draws to an end. Flashes yellow when the lamp cannot light up. (P46, 53-54)

WARNING TEMP. INDICATOR

Flashes red when internal projector temperature is too high. (P44, 53-54)

READY INDICATOR

Lights green when a projector is ready to be turned on. And it flashes green in Power Management mode. (P40, 44, 53-54)

LAMP INDICATOR

Becomes dim when a projector is turned on. And bright when a projector is in stand-by mode. (P20, 21, 53-54)

MENU BUTTON

Used to open or close MENU operation. (P18, 19)

ZOOM BUTTON

Used to adjust zoom. (P22)

FOCUS BUTTON

Used to adjust focus. (P22)

LENS SHIFT BUTTON

Used to select LENS SHIFT function. (P22)

POINT (VOLUME +/-) BUTTONS

Used to select an item or adjust value in ON-SCREEN MENU. They are also used to pan image in DIGITAL ZOOM +/- mode. (P30)
POINT LEFT/RIGHT buttons are also used as VOLUME +/- buttons. (P23)

SELECT BUTTON

Used to execute the selected item. It is also used to expand/compress image in DIGITAL ZOOM mode. (P30)

POWER ON-OFF BUTTON

Used to turn a projector on or off. (P20, 21)

INPUT BUTTON

Used to select input source. (P24, P31)

AUTO PC ADJ. BUTTON

Used to operate AUTO PC Adjustment function. (P26)

IMAGE BUTTON

Used to select image level. (P29, 33)

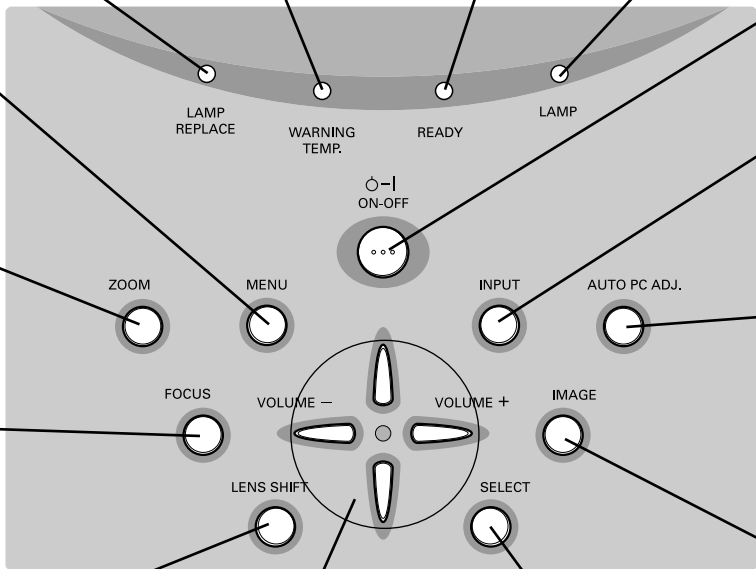

OPERATING ON-SCREEN MENU

HOW TO OPERATE ON-SCREEN MENU

You can control and adjust this projector through ON-SCREEN MENU. Refer to following pages to operate each adjustment on ON-SCREEN MENU.

1 DISPLAY MENU

Press MENU button to display ON-SCREEN MENU.

2 MOVING POINTER

Move pointer (* see below) or adjust value of item by pressing POINT buttons on Top Control or on Remote Control Unit.

* Pointer is icon on ON-SCREEN MENU to select item. See figures on section "FLOW OF ON-SCREEN MENU OPERATION" below.

3 SELECT ITEM

Select item or set selected function by pressing SELECT button.

REMOTE CONTROL UNIT

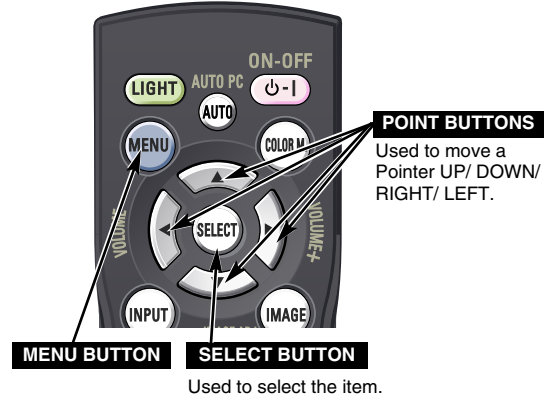

TOP CONTROL

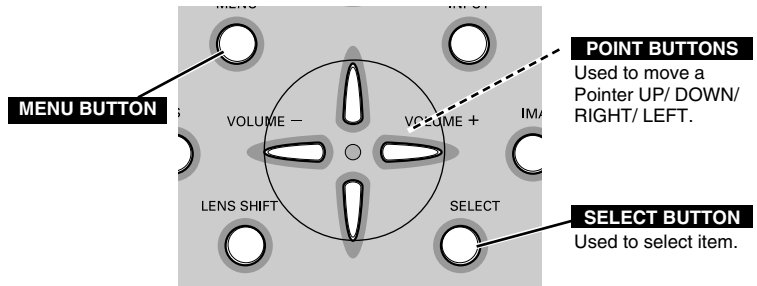

FLOW OF ON-SCREEN MENU OPERATION

Display ON-SCREEN MENU

1 Press MENU button to display ON-SCREEN MENU (MENU BAR). A red frame is POINTER.

Select Menu to be adjusted

2 Move POINTER (red frame) to MENU ICON that you want to select by pressing POINT RIGHT / LEFT buttons.

Control or adjust item through ON-SCREEN MENU

3 Press POINT UP/DOWN buttons and move POINTER (red frame or red arrow) to ITEM that you want to adjust, and then press SELECT button to show ITEM DATA.

4 Adjust ITEM DATA by pressing POINT RIGHT/LEFT buttons. Refer to following pages for details of respective adjustments.

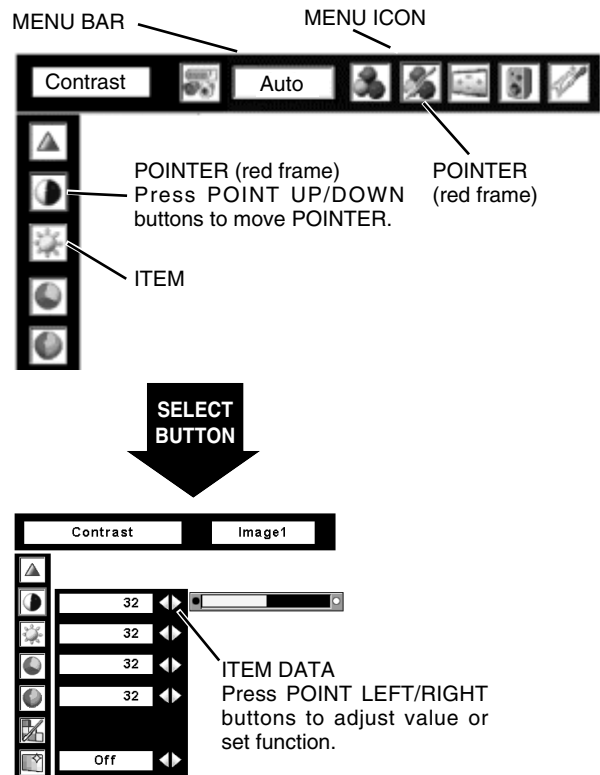

MENU BAR

FOR PC SOURCE

Press MENU BUTTON while connecting to PC input source.

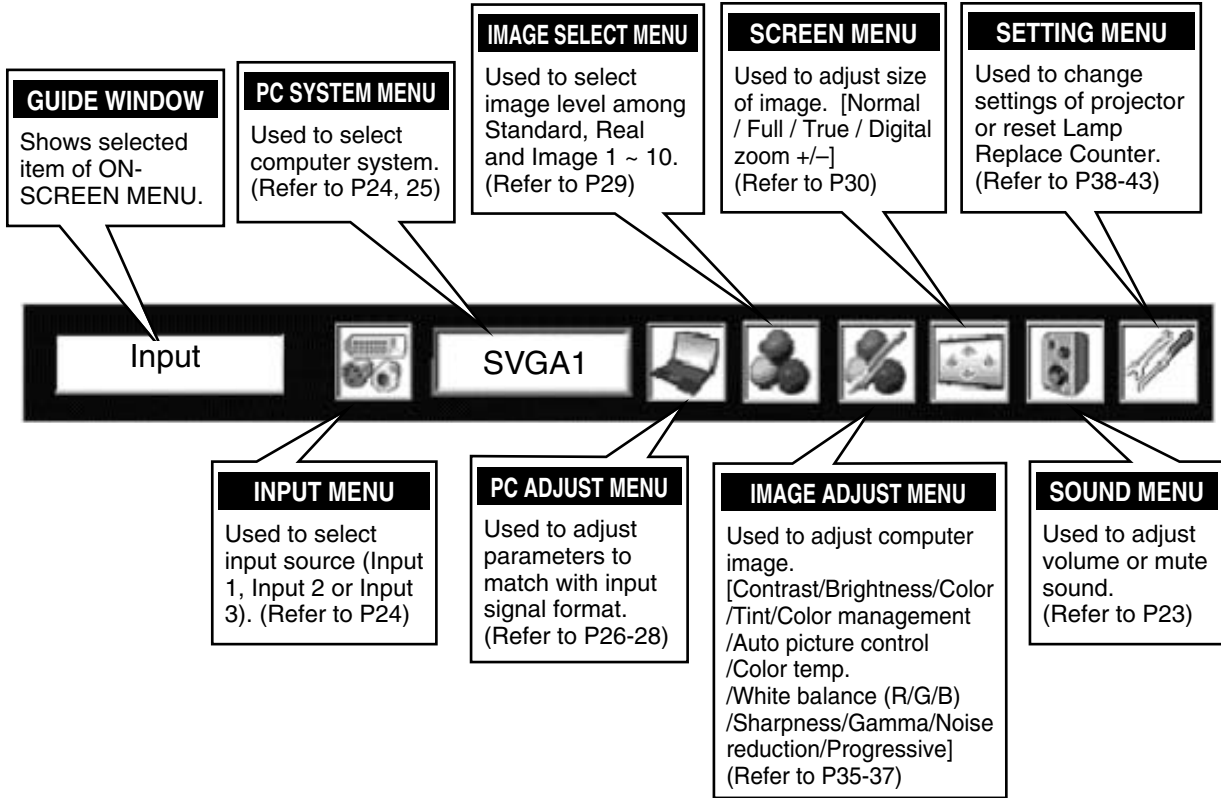

FOR VIDEO SOURCE

Press MENU BUTTON while connecting to VIDEO input source.

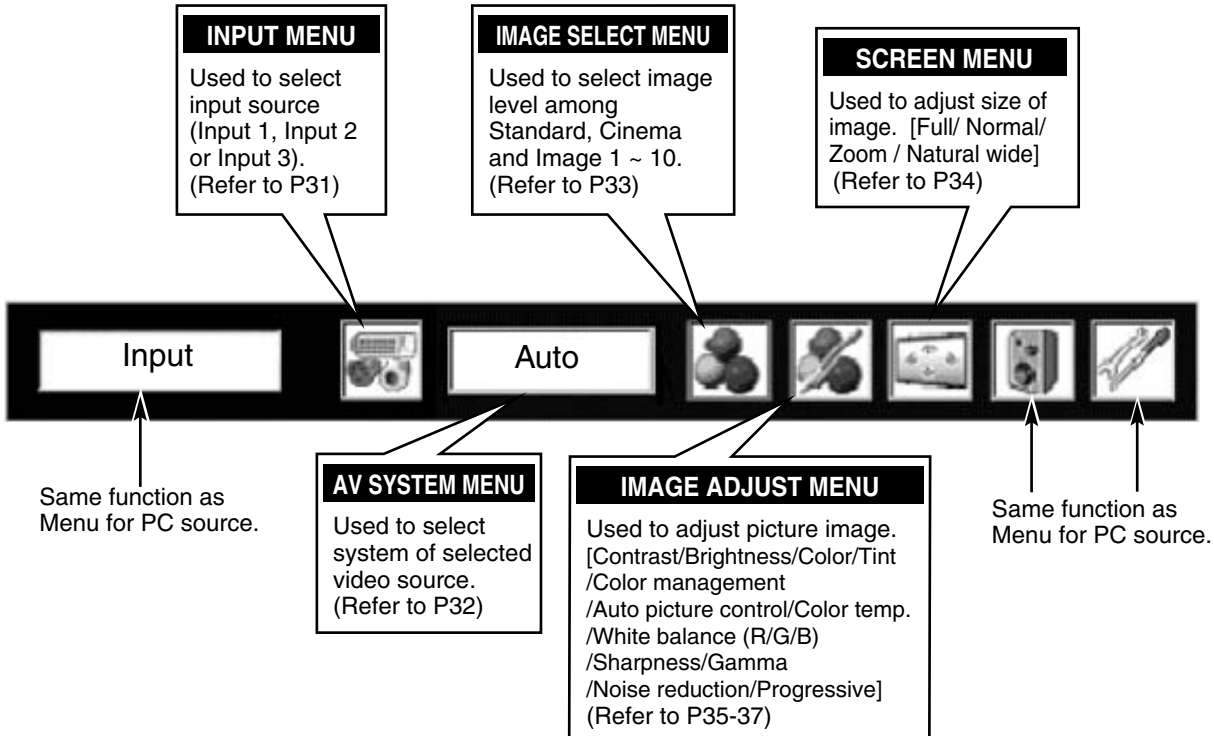

TURNING ON / OFF PROJECTOR

TURNING ON THE PROJECTOR

- 1 Complete peripheral connections (with a computer, VCR, etc.) before turning on the projector.
- 2 Connect the projector's AC power cord into an AC outlet. The LAMP Indicator lights RED, and READY Indicator lights GREEN.
- 3 Press the POWER ON-OFF button on the top control or on the remote control to ON. The LAMP Indicator dims, and the cooling fans start to operate. The preparation display appears on the screen and the count down starts.
- 4 After the count-down, the input source that was selected last and the Lamp control status icon (see page 40) appear on the screen.

If the projector is locked with a PIN code, PIN code Input Dialog Box will appear. Enter the PIN code as instructed below.

Enter a PIN code

Select a number by pressing the POINT LEFT/RIGHT button and fix the number with the SELECT button. The number will change to "*". If you fixed a wrong number, move the pointer to "Set" or "Clear" once by pressing the POINT DOWN button, then return to "PIN code". Enter the correct number again. Repeat this step to complete entering a four-digit number.

When the four-digit number is fixed, the pointer will automatically move to "Set". Press the SELECT button so that you can start to operate the projector.

If you entered a wrong PIN code, "PIN code" and the number (****) will turn red and disappear. Enter a correct PIN code all over again.

What is PIN code?

PIN code is a security code using Personal Identification Number that allows the person who knows it to operate the projector. Setting PIN code prevents others except the specific users from operating the projector.

A PIN code consists of a four-digit number. Refer to PIN Code Lock function in Setting on page 42 for locking operation of the projector with your PIN code.



CAUTION ON HANDLING PIN CODE

If you forget your PIN code, the projector can no longer be started. Set a new PIN code with special care, write it down in column on page 59 of this manual, and keep it at hand. Should the PIN code be missing or forgotten, consult your dealer or service center.



The preparation display disappears after 20 ~ 30 seconds.

Selected Input Source and Lamp control

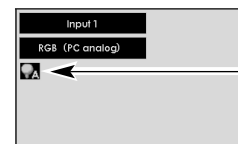

Lamp control status

For model PLV-80/PLV-80L only.
(See page 40 for Lamp control.)

PIN code Input Dialog Box



ok After the OK icon disappears, you can operate the projector.

TURNING OFF THE PROJECTOR

- 1** Press the POWER ON-OFF button on the top control or on the remote control, and a message "Power off?" appears on the screen.
- 2** Press the POWER ON-OFF button again to turn off the projector. The LAMP Indicator lights bright and READY Indicator turns off. After projector is turned off, Cooling Fans operate (for 90 seconds). During this "Cooling Down" period, this appliance cannot be turned on.
- 3** When the projector has cooled down, READY Indicator lights GREEN again and you can turn projector on. After cooling down completely, disconnect AC Power Cord.

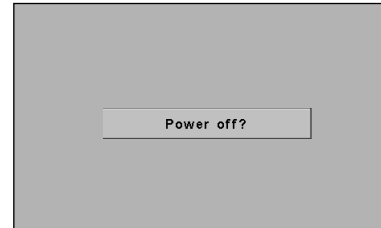

The message disappears after 4 seconds.



TO MAINTAIN THE LIFE OF LAMP, ONCE YOU TURN PROJECTOR ON, WAIT AT LEAST 5 MINUTES BEFORE TURNING IT OFF.

DO NOT DISCONNECT AC POWER CORD WHILE COOLING FANS ARE RUNNING OR BEFORE READY INDICATOR LIGHTS GREEN AGAIN. OTHERWISE IT WILL RESULT IN SHORTENING LAMP LIFE.

NOTE;

- The projector cannot be turned on during the cooling period with the READY indicator turned off. You can turn it on again after the READY indicator GREEN again.
- When the On start function is on, this projector is turned on automatically by connecting the AC power cord to an AC outlet. (See page 40 for the On start function.)
- Do not operate the projector continuously without rest. Continuous use may result in shortening the lamp life. Turn off the projector and give it a rest about an hour in every 24 hours.
- This projector monitors internal temperature and automatically controls the running speed of the cooling fans.
- If the WARNING TEMP indicator flashes red, see "WARNING TEMP INDICATOR" on page 44.

ADJUSTING SCREEN

ZOOM ADJUSTMENT

- 1** Press ZOOM button on Top Control or ZOOM ▲/▼ button on Remote Control Unit. Message “Zoom” is displayed.
- 2** Press ZOOM ▲ button or POINT UP button to make image larger, and press ZOOM ▼ button or POINT DOWN button to make image smaller.



Message disappears after 4 seconds.

FOCUS ADJUSTMENT

- 1** Press FOCUS button on Top Control or FOCUS ▲/▼ button on Remote Control Unit. Message “Focus” is displayed.
- 2** Adjust focus of image by pressing FOCUS ▲/▼ button or POINT UP/DOWN buttons.



Message disappears after 4 seconds.

NOTE;
Focus adjustment may not function properly if the image is corrected by KEYSTONE adjustment.

LENS SHIFT ADJUSTMENT

- 1** Press LENS SHIFT button on Top Control or LENS SHIFT ▲/▼ button on Remote Control Unit. Message “Lens shift” is displayed.
- 2** Press POINT UP button or LENS SHIFT ▲ button to move image up, press POINT DOWN or LENS SHIFT ▼ button to move image down.

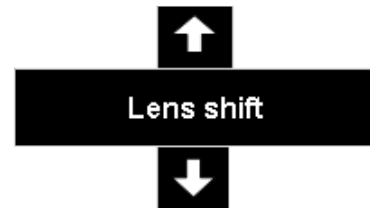

Message disappears after 4 seconds.

KEYSTONE ADJUSTMENT

If a projected picture has keystone distortion, correct the image with KEYSTONE adjustment.

- 1** Press KEYSTONE button on Remote Control Unit or select Keystone on SETTING menu. (Refer to page 38.) Keystone dialog box appears.
- 2** Correct keystone distortion by pressing POINT UP/DOWN/LEFT/RIGHT buttons. Press POINT UP button to reduce the upper part of the image, and press POINT DOWN button to reduce the lower part. Press POINT LEFT button to reduce the left part, and press POINT RIGHT button to reduce the right part.



- Arrows are white in no correction.
- Arrow(s) of direction being corrected turn(s) red.
- Arrow(s) disappear(s) at the maximum correction.
- If you press the KEYSTONE button on Remote Control Unit once more while the keystone dialog box is being displayed, the keystone adjustment will be canceled.

Reduce the upper width with POINT UP button.

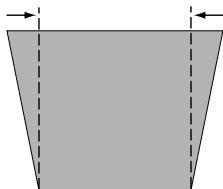

Reduce the lower width with POINT DOWN button.

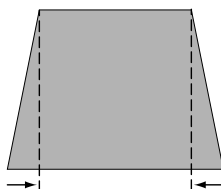

Reduce the left part with POINT LEFT button.

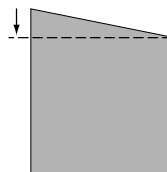

Reduce the right part with POINT RIGHT button.

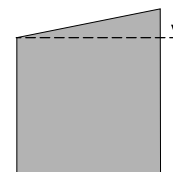

PICTURE FREEZE FUNCTION

Press FREEZE button on Remote Control Unit to freeze picture on-screen. To cancel FREEZE function, press FREEZE button again or press any other button.

NO SHOW FUNCTION

Press NO SHOW button on Remote Control Unit to black out image. To restore to normal, press NO SHOW button again or press any other button.

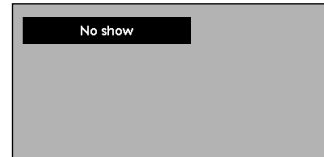

Message disappears after 4 seconds.

SOUND ADJUSTMENT

DIRECT OPERATION

Volume

Press VOLUME (+/-) buttons on Top Control or on Remote Control Unit to adjust volume. Volume dialog box appears on screen for a few seconds.

(+) button to increase volume, and (-) button for decreasing.

Mute

Press MUTE button on Remote Control Unit to cut off sound. To restore sound to its previous level, press MUTE button again or press Volume (+/-) buttons.

Indicates roughly level of volume.

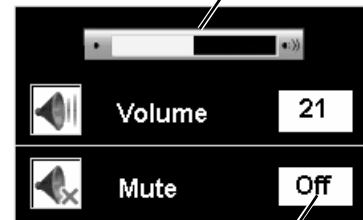

Press MUTE button to set Mute function On or Off.

Display disappears after 4 seconds.

MENU OPERATION

1 Press MENU button and ON-SCREEN MENU will appear. Press POINT LEFT/RIGHT buttons to move a red frame pointer to SOUND Menu icon.

2 Press POINT UP/DOWN buttons to move a red frame pointer to item that you want to select, and then press SELECT button.



Volume

To increase volume, press POINT RIGHT button, and press POINT LEFT button for decreasing.



Mute

Press POINT LEFT/RIGHT buttons to cut off sound. Dialog box display is changed to "On" and sound is cut off. To restore sound to its previous level, press POINT LEFT/RIGHT buttons again.

SOUND MENU

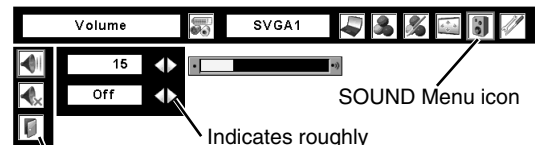

Indicates roughly level of volume.

Close SOUND Menu

SELECTING INPUT SOURCE

DIRECT OPERATION

Select INPUT source by pressing INPUT button on Top Control or on Remote Control Unit.

Select INPUT source by pressing INPUT 1, INPUT 2 or INPUT 3 button on Remote Control Unit.

If projector cannot reproduce proper image, select correct input source through MENU OPERATION (see below).

INPUT button

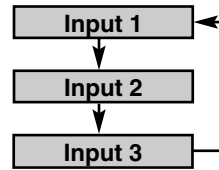

SELECTING COMPUTER SYSTEM

WHEN SELECT INPUT 1 (COMPUTER INPUT TERMINALS)

- 1 Press MENU button and ON-SCREEN MENU will appear. Press POINT LEFT/RIGHT buttons to move a red frame pointer to INPUT Menu icon.
- 2 Press POINT UP/DOWN buttons to move a red arrow pointer to Input 1 and then press SELECT button. Source Select Menu will appear.
- 3 Move a pointer to source that you want to select and then press SELECT button.

INPUT MENU

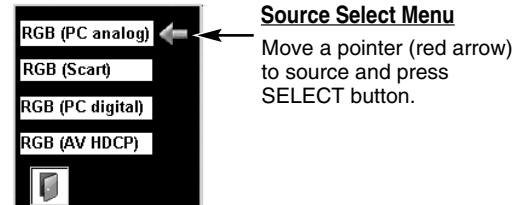
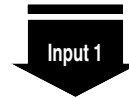
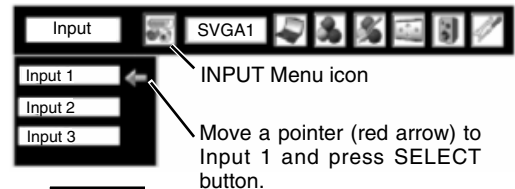

RGB (PC analog)

When your computer is connected to INPUT 1 (ANALOG) terminal, select RGB (PC analog).

RGB (Scart)

When scart video equipment is connected to INPUT 1 (ANALOG) terminal, select RGB (Scart).

RGB (PC digital)

When your computer is connected to INPUT 1 (DIGITAL) terminal, select RGB (PC digital).

RGB (AV HDCP)

If a HDCP-compatible signal source is connected to the INPUT 1 (DIGITAL) terminal, select RGB (AV HDCP).

NOTE;
INPUT SOURCE changes if the INPUT 1 button on Remote Control Unit is pressed.

NOTE;
HDCP (High-bandwidth Digital Content Protection) is a system for protecting digital entertainment content which is delivered by DVI (Digital Visual Interface) from being copied. The specification of HDCP is decided and controlled by Digital Content Protection, LLC. Should the specification be changed, this projector may not display the digital content protected by HDCP.

WHEN SELECT INPUT 2 (5 BNC INPUT JACKS)

When connect a computer output [5 BNC Type (Green, Blue, Red, Horiz. Sync and Vert. Sync.)] from a computer to G, B, R, H/HV and V jacks.

- 1 Press MENU button and ON-SCREEN MENU will appear. Press POINT LEFT/RIGHT buttons to move a red frame pointer to INPUT Menu icon.
- 2 Press POINT UP/DOWN buttons to move a red arrow pointer to Input 2 and then press SELECT button. Source Select Menu will appear.
- 3 Press POINT UP/DOWN buttons and a red-arrow icon will appear. Move arrow to "RGB", and then press SELECT button.

NOTE;
INPUT SOURCE changes if the INPUT 2 button on Remote Control Unit is pressed.

INPUT MENU

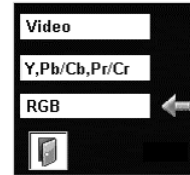
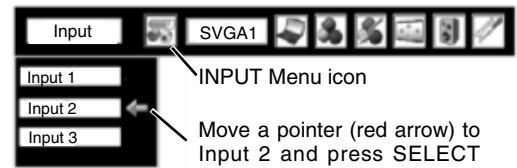

AUTOMATIC MULTI-SCAN SYSTEM

This projector automatically tunes to most different types of computers based on VGA, SVGA, XGA, SXGA, SXGA+, WXGA or UXGA (refer to "COMPATIBLE COMPUTER SPECIFICATION" on pages 52-53). When a computer is selected, this projector automatically tunes to incoming signal and projects the proper image without any special setting. (Some computers need to be set manually.)

The projector displays one of the Auto, -----, Mode 1/2/3/4/5/6/7/8/9/10, or the system provided in the projector.

- Auto** When projector cannot recognize connected signal as PC system provided in this projector, Auto PC Adjustment function operates to adjust projector and message "Auto" is displayed on SYSTEM Menu icon. When image is not provided properly, manual adjustment is required. (Refer to P27 and 28.)
- There is no signal input from computer. Make sure connection of computer and a projector is set correctly. (Refer to TROUBLESHOOTING on page 48.)
- Mode 1** User preset adjustment in MANUAL PC ADJUSTMENT. Adjustment data can be stored in the Mode 1-10.
- SVGA 1** Computer systems provided in the projector. The projector chooses proper system and displays it.

* Mode 1 and SVGA 1 are examples.

SELECT COMPUTER SYSTEM MANUALLY

This projector automatically selects PC system among those provided in this projector and PC system can be also selected manually.

- 1 Press MENU button and ON-SCREEN MENU will appear. Press POINT LEFT/RIGHT buttons to move a red frame pointer to PC SYSTEM Menu icon.
- 2 Press POINT UP/DOWN buttons to move a red arrow pointer to system that you want to set, and then press SELECT button.

PC SYSTEM MENU



PC SYSTEM MENU

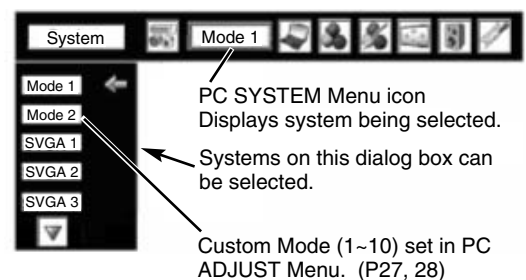

PC ADJUSTMENT

AUTO PC ADJUSTMENT

Auto PC Adjustment function is provided to automatically adjust Fine sync, Total dots and Picture Position to conform to your computer. Auto PC Adjustment function can be operated as follows.



Auto PC Adj.

- 1 Press MENU button and ON-SCREEN MENU will appear. Press POINT LEFT/RIGHT buttons to move a red frame pointer to PC ADJUST Menu icon.
- 2 Press POINT UP/DOWN buttons to move a red frame pointer to AUTO PC Adj. icon and then press SELECT button. This Auto PC Adjustment can be also executed by pressing AUTO PC ADJ. button on Top Control or on Remote Control Unit.

Store adjustment parameters.

Adjustment parameters from Auto PC Adjustment can be memorized in this projector. Once parameters are memorized, setting can be done just by selecting Mode in PC SYSTEM Menu (P25). Refer to MANUAL PC ADJUSTMENT section (P27-28).

PC ADJUST MENU

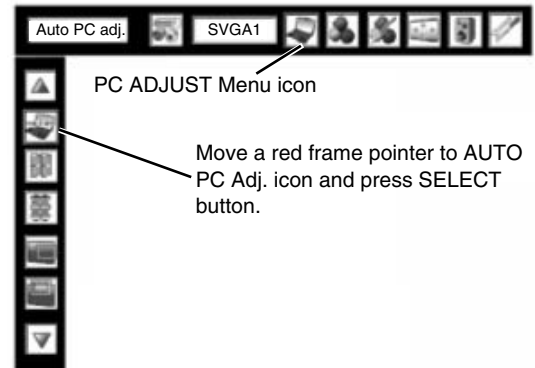

PC ADJUST Menu icon

Move a red frame pointer to AUTO PC Adj. icon and press SELECT button.

NOTE

- Fine sync, Total dots and Picture Position of some computers can not be fully adjusted with this Auto PC Adjustment function. When image is not provided properly through this function, manual adjustments are required. (Refer to pages 27, 28.)
- Auto PC Adjustment function cannot be operated in Digital Signal input on DVI terminal and “480p”, “575p”, “480i”, “575i” “720p (HDTV)”, “1035i (HDTV)” or “1080i (HDTV)” is selected on PC SYSTEM Menu.

MANUAL PC ADJUSTMENT

This projector can automatically tune to display signals from most personal computers currently distributed. However, some computers employ special signal formats which are different from standard ones and may not be tuned by Multi-Scan system of this projector. If this happens, projector cannot reproduce a proper image and image may be recognized as a flickering picture, a non-synchronized picture, a non-centered picture or a skewed picture.

This projector has a Manual PC Adjustment to enable you to precisely adjust several parameters to match with those special signal formats. This projector has 10 independent memory areas to memorize those parameters manually adjusted. This enables you to recall setting for a specific computer whenever you use it.

Note : This PC ADJUST Menu cannot be operated when in digital signal input on DVI terminal is selected on PC SYSTEM MENU (P24).

- 1 Press MENU button and ON-SCREEN MENU will appear. Press POINT LEFT/RIGHT buttons to move a red frame pointer to PC ADJUST Menu icon.
- 2 Press POINT UP/DOWN buttons to move a red frame pointer to item that you want to adjust and then press SELECT button. Adjustment dialog box will appear. Press POINT LEFT/RIGHT buttons to adjust value.



Fine sync

Adjusts an image as necessary to eliminate flicker from display. Press POINT LEFT/RIGHT buttons to adjust value. (From 0 to 31.)



Total dots

Adjust the number of total dots in one horizontal period. Press POINT LEFT/RIGHT buttons and adjust number to match your PC image.



Position H

Adjusts horizontal picture position. Press POINT LEFT/RIGHT buttons to adjust position.



Position V

Adjusts vertical picture position. Press POINT LEFT/RIGHT button(s) to adjust position.



Current mode

Press SELECT button to show information of computer selected.



Clamp

Adjusts clamp position. When image has a dark bar(s), try this adjustment.



Display area H

Adjustment of horizontal area displayed with this projector. Press POINT LEFT/RIGHT buttons to decrease/increase value and then press SELECT button.



Display area V

Adjustment of vertical area displayed with this projector. Press POINT LEFT/RIGHT buttons to decrease/increase value and then press SELECT button.

PC ADJUST MENU

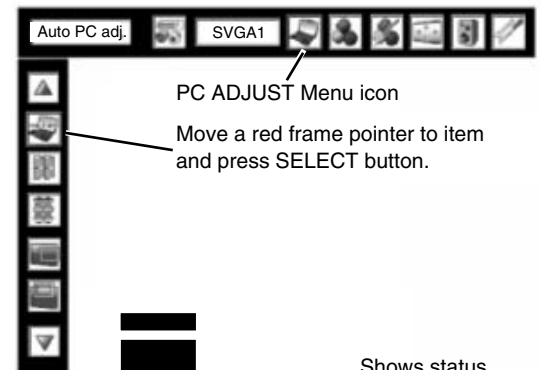

PC ADJUST Menu icon
Move a red frame pointer to item and press SELECT button.

Shows status (Stored / Free) of selected Mode.



Selected Mode

Press POINT LEFT/RIGHT buttons to adjust value.

Press SELECT button at this icon to adjust "Clamp," "Display area H" or set "Display area V."

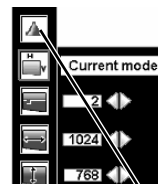

Current mode

H-sync freq.	48.5
V-sync freq.	60

Press SELECT button at Current mode icon to show information of computer connected.

Press SELECT button at this icon to display previous items.

COMPUTER INPUT

Other icons operates as follows.



Reset all adjust parameters on adjustment dialog box to previous figure.



To clear adjustment parameters previously set, move a red frame pointer to Mode free icon and then SELECT button. Move a red arrow pointer to Mode that you want to clear and then press SELECT button.



To store adjustment parameters, move a red frame pointer to Store icon and then press SELECT button. Move a red arrow pointer to any of Mode 1 to 10 that you want to store and then press SELECT button.

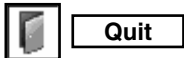

Closes PC ADJUST MENU.

To store adjustment data.

This Mode has parameters being stored.

Where to store ?							
Mode 1	Stored	0	0	0	0	0	←
Mode 2	Free	0	0	0	0	0	
Mode 3	Free	0	0	0	0	0	
Mode 4	Free	0	0	0	0	0	
Mode 5	Free	0	0	0	0	0	

Vacant Mode

Close this dialog box.

Shows values of "Total dots," "Position H," "Position V," "Display area H," and "Display area V."

To clear adjustment data.

Where to free?							
Mode 1	Stored	0	0	0	0	0	←
Mode 2	Free	0	0	0	0	0	
Mode 3	Free	0	0	0	0	0	
Mode 4	Free	0	0	0	0	0	
Mode 5	Free	0	0	0	0	0	

Close this dialog box.

PICTURE IMAGE SELECT

IMAGE LEVEL SELECT (DIRECT)

Select image level among Standard, Real, Image 1 to Image 10 by pressing IMAGE button on Top Control or IMAGE SELECTION ▲/▼ button on Remote Control Unit.

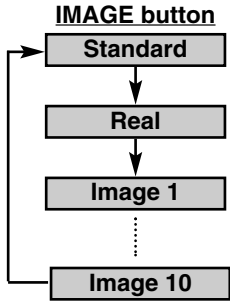

Standard

Normal picture level preset on this projector.

Real

Picture level with improved halftone for graphics.

IMAGE 1~10

User preset picture adjustment in IMAGE ADJUST Menu (P37).

IMAGE LEVEL SELECT (MENU)

- 1 Press MENU button and ON-SCREEN MENU will appear. Press POINT LEFT/RIGHT buttons to move a red frame pointer to IMAGE SELECT Menu icon.
- 2 Press POINT UP/DOWN buttons to move a red frame pointer to level that you want to set and then press SELECT button.

IMAGE SELECT MENU

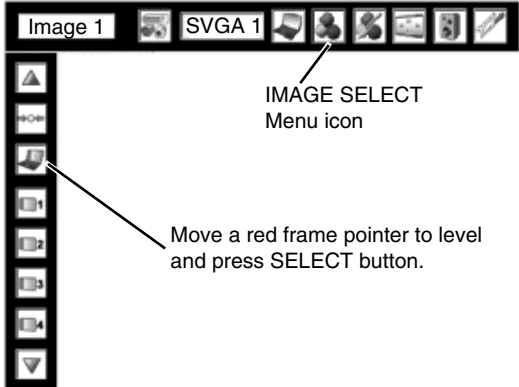

Standard

Normal picture level preset on this projector.



Real

Picture level with improved halftone for graphics.



IMAGE 1~10

User preset picture adjustment in IMAGE ADJUST Menu (P37).

PICTURE SCREEN ADJUSTMENT

This projector has a picture screen resize function, which enables you to display desirable image size.

PICTURE SCREEN SELECT (DIRECT)

Select picture screen among Normal, Full and True by pressing SCREEN button on Remote Control Unit.

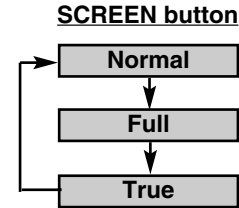

PICTURE SCREEN SELECT (MENU)

- 1 Press MENU button and ON-SCREEN MENU will appear. Press POINT LEFT/RIGHT buttons to move a red frame pointer to SCREEN Menu icon.
- 2 Press POINT UP/DOWN buttons and move a red frame pointer to function that you want to select and then press SELECT button.

SCREEN MENU

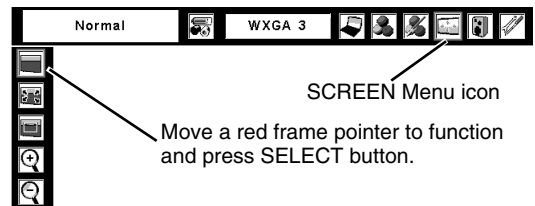

Normal

Provides image to fit the panel size of the screen.



Full

Provides image to fit the horizontal size of the screen.



True

Provides image in its original size. When the original image size is larger than screen size (1366 X 768), this projector enters "D. Zoom +" mode automatically.



Digital zoom +

When Digital zoom + is selected, ON-SCREEN MENU disappears and message "D. Zoom +" is displayed. Press SELECT button to expand image size. And press POINT UP/DOWN/LEFT/RIGHT button(s) to pan image. Panning function can work only when image is larger than screen size.

A projected image can be also expanded by pressing D.ZOOM and SELECT button on Remote Control Unit.



Digital zoom -

When Digital zoom - is selected, ON-SCREEN MENU disappears and message "D. Zoom -" is displayed. Press SELECT button to compress image size.

A projected image can be also compressed by pressing D.ZOOM and SELECT button on Remote Control Unit.

To cancel Digital Zoom +/- mode, press any button except D.ZOOM, SELECT and POINT buttons.

NOTE

- Picture screen adjustment can not be operated when "720p (HDTV)", "1035i (HDTV)" or "1080i (HDTV)" is selected on PC SYSTEM Menu (P25).
- True and Digital zoom +/- can not be selected when "480i", "575i", "480p" or "575p" is selected on PC SYSTEM Menu (P25).
- This projector cannot display any resolution higher than 1600 X 1200. If your computer's screen resolution is higher than 1600 X 1200, reset resolution to lower before connecting projector.
- Image data in other than XGA (1024 x 768) is modified to fit screen size in initial mode.
- Panning function may not operate properly if computer system prepared on PC ADJUST Menu is used.

SELECTING INPUT SOURCE

DIRECT OPERATION

Select INPUT source by pressing INPUT button on Top Control or on Remote Control Unit.

Select INPUT source by pressing INPUT 1, INPUT 2 or INPUT 3 button on Remote Control Unit.

If projector cannot reproduce proper image, select correct input source through MENU OPERATION (see below).

INPUT button

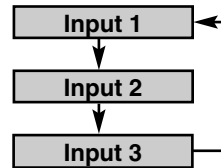

SELECTING INPUT SOURCE

WHEN SELECT INPUT 2 (5 BNC INPUT JACKS)

When connecting to those equipment, select a type of Video source in SOURCE SELECT Menu.

- 1 Press MENU button and ON-SCREEN MENU will appear. Press POINT LEFT/RIGHT buttons to move a red frame pointer to INPUT Menu icon.
- 2 Press POINT UP/DOWN buttons to move a red arrow pointer to Input 2 and then press SELECT button. Source Select Menu will appear.
- 3 Move a pointer to source that you want to select and then press SELECT button.

Video When video input signal is connected to VIDEO jack, select Video.

Y,Pb/Cb,Pr/Cr When video input signal is connected to Y-Pb/Cb-Pr/Cr jacks, select Y, Pb/Cb, Pr/Cr.

NOTE;
INPUT SOURCE changes if the INPUT 2 button on Remote Control Unit is pressed.

INPUT MENU

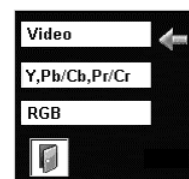
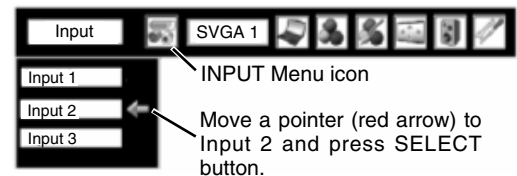

Source Select Menu

Move a pointer (red arrow) to Video or Y, Pb/Cb, Pr/Cr and press SELECT button.

WHEN SELECT INPUT 3 (AV TERMINALS)

When connecting to those equipment, select a type of Video source in SOURCE SELECT (VIDEO) Menu.

- 1 Press MENU button and ON-SCREEN MENU will appear. Press POINT LEFT/RIGHT buttons to move a red frame pointer to INPUT Menu icon.
- 2 Press POINT UP/DOWN buttons to move a red arrow pointer to Input 3 and then press SELECT button. Source Select Menu will appear.
- 3 Move a pointer to source that you want to select and then press SELECT button.

Video When video input signal is connected to VIDEO jack, select Video.

Y,Pb/Cb,Pr/Cr When video input signal is connected to Y-Pb/Cb-Pr/Cr jacks, select Y, Pb/Cb, Pr/Cr.

S-Video When video input signal is connected to S-VIDEO jack, select S-Video.

NOTE;
INPUT SOURCE changes if the INPUT 3 button on Remote Control Unit is pressed.

INPUT MENU

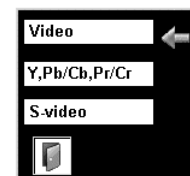
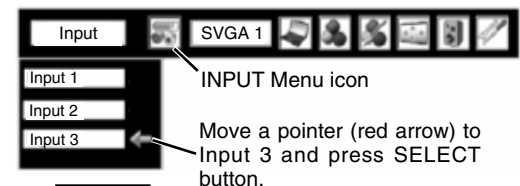

Source Select Menu (VIDEO)

Move a pointer (red arrow) to source and press SELECT button.

SELECTING VIDEO SYSTEM

- 1 Press MENU button and ON-SCREEN MENU will appear. Press POINT LEFT/RIGHT buttons to move a red frame pointer to AV SYSTEM Menu icon.
- 2 Press POINT UP/DOWN buttons to move a red arrow pointer to system that you want to select and then press SELECT button.

VIDEO JACK OR S-VIDEO JACK

Auto

Projector automatically detects incoming Video system, and adjusts itself to optimize its performance.

PAL / SECAM / NTSC / NTSC4.43 / PAL-M / PAL-N

If projector cannot reproduce proper video image, it is necessary to select a specific broadcast signal format among PAL, SECAM, NTSC, NTSC 4.43, PAL-M, and PAL-N.

AV SYSTEM MENU (VIDEO OR S-VIDEO)

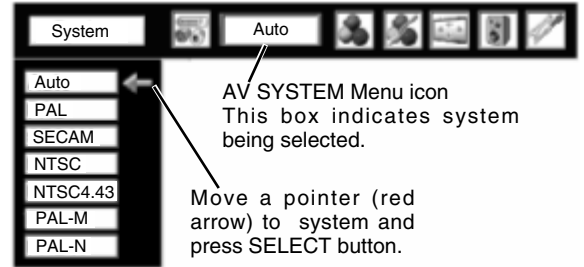

Y, Pb/Cb, Pr/Cr JACKS

Auto

Projector automatically detects incoming Video signal, and adjusts itself to optimize its performance.

When Video System is 1035i or 1080i, select system manually first.

COMPONENT VIDEO SIGNAL FORMAT

If projector cannot reproduce proper video image, it is necessary to select a specific component video signal format among 480i, 575i, 480p, 575p, 720p, 1035i and 1080i.

AV SYSTEM MENU (COMPONENT VIDEO)

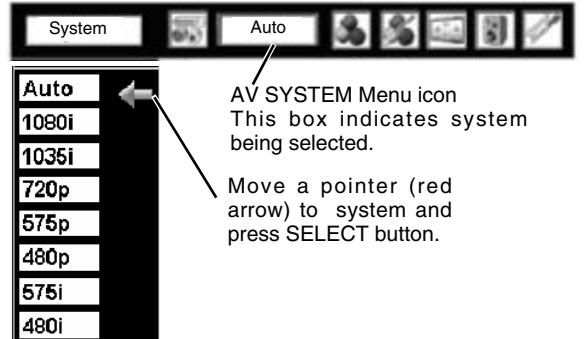

PICTURE IMAGE SELECT

IMAGE LEVEL SELECT (DIRECT)

Select image level among Standard, Cinema, Image 1 to Image 10 by pressing IMAGE button on Top Control or IMAGE SELECTION ▲/▼ button on Remote Control Unit.

Standard

Normal picture level preset on this projector.

Cinema

Picture level adjusted for picture with fine tone.

IMAGE 1~10

User preset picture adjustment in IMAGE ADJUST Menu (P37).

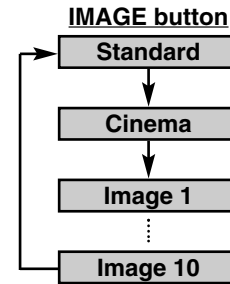
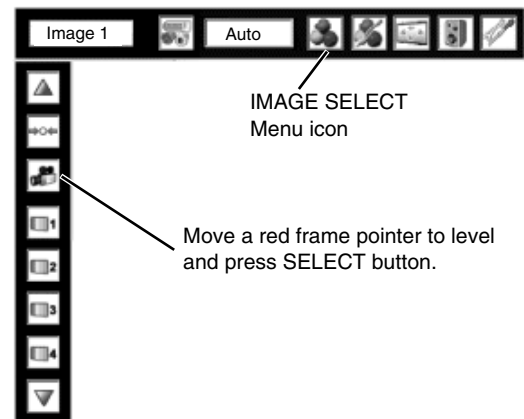

IMAGE LEVEL SELECT (MENU)

- 1 Press MENU button and ON-SCREEN MENU will appear. Press POINT LEFT/RIGHT buttons to move a red frame pointer to IMAGE SELECT Menu icon.
- 2 Press POINT UP/DOWN buttons to move a red frame pointer to level that you want to set and then press SELECT button.

IMAGE SELECT MENU



Standard

Normal picture level preset on this projector.



Cinema

Picture level adjusted for picture with fine tone.



IMAGE 1~10

User preset picture adjustment in IMAGE ADJUST Menu (P37).

PICTURE SCREEN ADJUSTMENT

This projector has a picture screen resize function, which enables you to display desirable image size.

PICTURE SCREEN SELECT (DIRECT)

Select picture screen among Full, Normal, Zoom and Natural wide by pressing SCREEN button on Remote Control Unit.

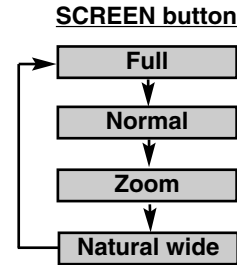

PICTURE SCREEN SELECT (MENU)

- 1 Press MENU button and ON-SCREEN MENU will appear. Press POINT LEFT/RIGHT buttons to move a red frame pointer to SCREEN Menu icon.
- 2 Press POINT DOWN button and move a red frame pointer to function that you want to select and then press SELECT button.

SCREEN MENU

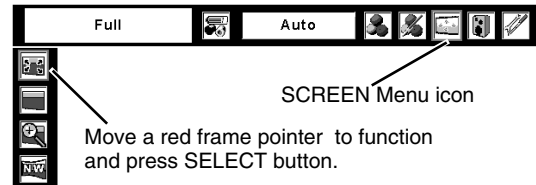

 **Full**

Provides image to fit width of screen by expanding image width uniformly. This function can be used for providing a squeezed video signal at wide video aspect ratio of 16 : 9. When your video equipment (such as DVD) has 16 : 9 output mode, select 16 : 9 and select Full on this SCREEN Menu to provide better quality.

 **Normal**

Provides image at the normal video aspect ratio of 4 : 3.

 **Zoom**

Provides image to fit screen size (16 : 9 aspect ratio) by expanding image width and height uniformly. This function can be used for providing a letter box mode picture (4 : 3 aspect picture with black bar on top and bottom edges) at wide video aspect of 16 : 9.

 **Natural wide**

Provides image to fit width of screen by expanding both sides of image. This function is suitable to provide a normal video signal (4 : 3 aspect ratio) at wide video aspect ratio of 16 : 9.

NOTE : SCREEN Menu can not be operated when "720p", "1035i" or "1080i" is selected on AV SYSTEM Menu (P32).

PICTURE IMAGE ADJUSTMENTS

- 1 Press MENU button and ON-SCREEN MENU will appear. Press POINT LEFT/RIGHT buttons to move a red frame pointer to IMAGE ADJUST Menu icon.
- 2 Press POINT UP/DOWN buttons to move a red frame pointer to item that you want to adjust and then press SELECT button. Level of each item is displayed. Adjust each level by pressing POINT LEFT/RIGHT buttons.



Contrast

Press POINT LEFT button to decrease contrast, and POINT RIGHT button to increase contrast. (From 0 to 63.)



Brightness

Press POINT LEFT button to adjust image darker, and POINT RIGHT button to adjust brighter. (From 0 to 63.)



Color

Press POINT LEFT button to lighten color, and POINT RIGHT button to deepen color. (From 0 to 63.)



Tint

Press POINT LEFT button or POINT RIGHT button to obtain proper color. (From 0 to 63.)



Color Management

The Color management function can be used to adjust the level, phase and gamma of the selected display colors (except black, white and gray) on the screen, and to replace these colors with other colors if required.

The projector lets you replace up to eight colors for each image. There are ten preset images for VIDEO mode and ten preset images for PC, giving a total of twenty images.

- 1 Press the POINT UP/DOWN buttons to move a red frame pointer to "COLOR MANAGEMENT", and then press the SELECT button. The COLOR MANAGEMENT menu will appear and pointer mode will be enabled. The image that was being projected when the button was pressed will be paused, and the COLOR MANAGEMENT POINTER will appear.
- 2 Use the POINT buttons to move a pointer to a section of the paused image that contains the color that you would like to adjust, and then press the SELECT button. The mode will change to COLOR SELECTION mode, and the color in the center of the pointer will be selected and adjustment will be possible.
- 3 Use the POINT buttons to adjust the level and phase of the color, and then press the SELECT button to confirm the setting. Next, use the POINT buttons to adjust the gamma correction for the color, and then press the SELECT button to accept the setting. When the SELECT button is pressed, the mode will change to LIST mode.

IMAGE ADJUST MENU

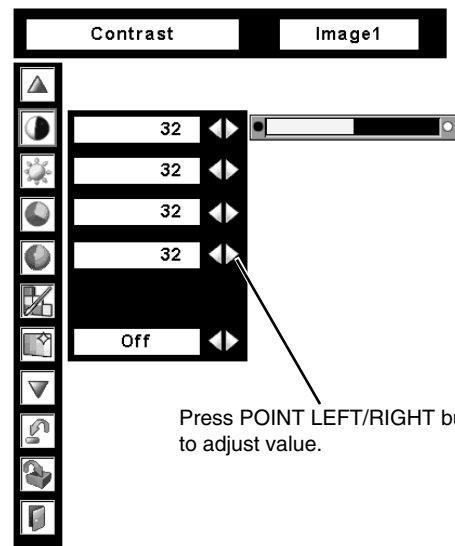
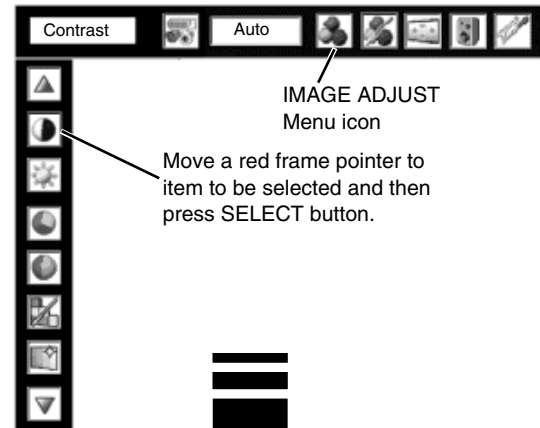

POINTER MODE

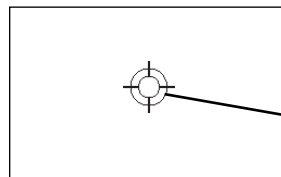

COLOR MANAGEMENT POINTER

NOTE;

Press the COLOR M. button on the remote control to display the COLOR MANAGEMENT menu. If you would like to check or re-adjust a color management setting that has already been made, press the COLOR M. button on the remote control once more to change to LIST mode.

PICTURE IMAGE

- To move a red frame pointer to "MENU", and then press the SELECT button. The COLOR MANAGEMENT menu will be exited and the display will return to the IMAGE ADJUST menu. (At this time, the image will stop being paused and normal projection will resume.) After changing the COLOR MANAGEMENT settings, use the IMAGE ADJUST menu to store the changed settings.

COLOR SELECTION MODE

COLOR M.

The mode will return to the pointer mode (even if you press the MENU key on the projector or the remote control). (You will need to reselect and re-adjust the color in this case.)

MENU

The COLOR MANAGEMENT menu will be exited and the display will return to the normal projection screen, but any settings that have been changed will not be stored. To store the changed settings, be sure to select "LIST" using the POINT buttons and change to the next mode (LIST mode).

LIST MODE



The check mark will be cleared and the effect of the setting adjustment for that line on the projected images will be momentarily canceled.

COLOR PALETTE

The mode will return to COLOR SELECTION mode so that you can re-adjust the setting for the color in that line. This option is not available if the check mark has been cleared by the operation immediately above.)

DEL

The setting adjustment for the color in that line will be canceled.

ALL DEL

The setting adjustment for the colors in all lines will be canceled.

COLOR M.

The mode will return to POINTER mode.



Auto picture control

Press either POINT LEFT button or POINT RIGHT button to Auto picture control position that you want to select. (Off, L1 or L2)

Off Auto picture control OFF position.

L1 Auto picture control LEVEL 1 position.

L2 Auto picture control LEVEL 2 position.

COLOR SELECTION MODE

Level and phase adjustment palette.

Gamma adjustment palette.

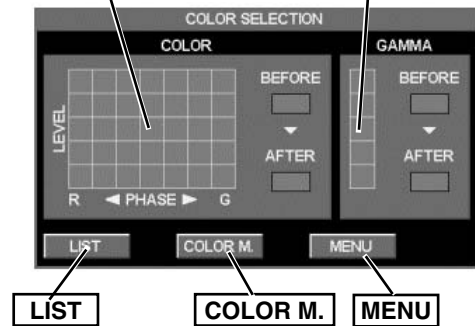

LIST MODE

COLOR PALETTE

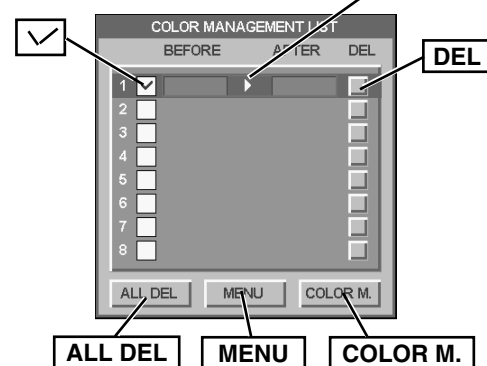

NOTE;

If you press the COLOR M. button on the remote control, the COLOR MANAGEMENT menu will be exited and the display will return to the normal projection screen, but any settings that have been changed will not be stored. To store the changed settings, be sure to select "MENU" using the POINT buttons and store the settings.



Color temp.

Press either POINT LEFT button or POINT RIGHT button to Color temp. level that you want to select. (XLow, Low, Mid or High)



White balance (Red)

Press POINT LEFT button to lighten red tone and POINT RIGHT button to deeper tone. (From 0 to 63.)



White balance (Green)

Press POINT LEFT button to lighten green tone and POINT RIGHT button to deeper tone. (From 0 to 63.)



White balance (Blue)

Press POINT LEFT button to lighten blue tone and POINT RIGHT button to deeper tone. (From 0 to 63.)



Sharpness

Press POINT LEFT button to soften the image, and POINT RIGHT button to sharpen the image. (From 0 to 31.)



Gamma

Press either POINT LEFT button or POINT RIGHT button to obtain better balance of contrast. (From 0 to 15.)



Noise reduction

Press POINT LEFT/RIGHT buttons to change noise reduction mode. Dialog box display is changed to "Off", "L1", "L2".

- Off ... Noise reduction mode to OFF.
- L1 Noise reduction mode to L1.
- L2 Noise reduction mode to L2.



Progressive

Press POINT LEFT/RIGHT buttons to change progressive scan mode. Dialog box display is changed to "Off", "On", "Film".

- Off ... Progressive scan mode to OFF.
- On Progressive scan mode to ON.
- Film Effective on 3:2 pulldown video sources.

Other icons operates as follows.



Reset

Reset all adjustment to previous figure.



Store

To store manually preset image, move a red frame pointer to Store icon and press SELECT button. Image Level Menu will appear. Move a red frame pointer to Image 1 to 10 where you want to set and then press SELECT button.



Quit

Closes IMAGE ADJUST MENU.

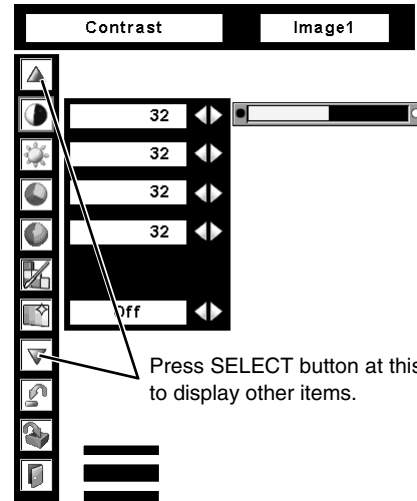

Press SELECT button at this icon to display other items.

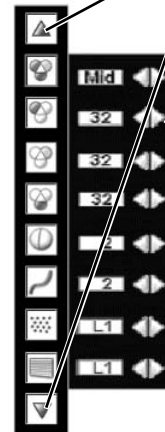

Press SELECT button at this icon to display previous items.

Press POINT LEFT/RIGHT buttons to adjust value.

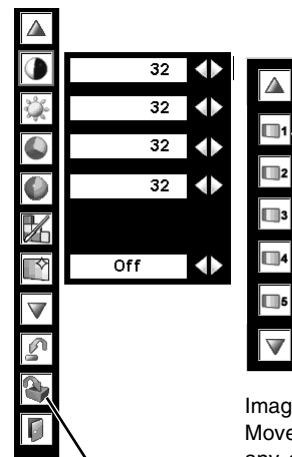

Image Level Menu
Move a red frame pointer to any of Image 1 to 10 where you want to set and then press SELECT button.

Store icon
Press SELECT button at this icon to store the adjustment.

SETTING MENU

This projector has Setting menu that allows you to set up the other various functions described as follows;

- 1 Press the MENU button to display the On-Screen Menu. Press the POINT LEFT/RIGHT buttons to move a red frame pointer to the Setting Menu icon.
- 2 Press the POINT DOWN button to move a red frame pointer to the item that you want to set and then press the SELECT button. The Setting dialog box appears.

Language

The language used in the On-Screen Menu is available in English, German, French, Italian, Spanish, Portuguese, Dutch, Swedish, Russian, Chinese, Korean, or Japanese.

Keystone

This function corrects distortion of a projected image. Select either Store or Reset with the POINT LEFT/RIGHT buttons, and then press the Select button. The keystone dialog box appears. Adjust keystone with the POINT UP/DOWN/LEFT/RIGHT buttons.

Store stores the keystone adjustment even if the AC power cord is disconnected.

Reset resets the keystone adjustment when the AC power cord is disconnected.

Background

3 background settings are available in this projector. Select one of the followings when no input source is connected to the projector or no input signal is coming from the connected equipment:

- Blue blue colored background
- My logo . . . the image you captured
- Black black colored background

Display

This function decides whether to display On-Screen Displays.

Off does not show On-Screen Display except;

- On-Screen Menu
- "Power off?" message
- "No signal" message
- "Please wait..."
- Color management operation screen

Count-down Off does not show Count-down Display.

On shows all the On-Screen Display.

SETTING MENU (LANGUAGE)

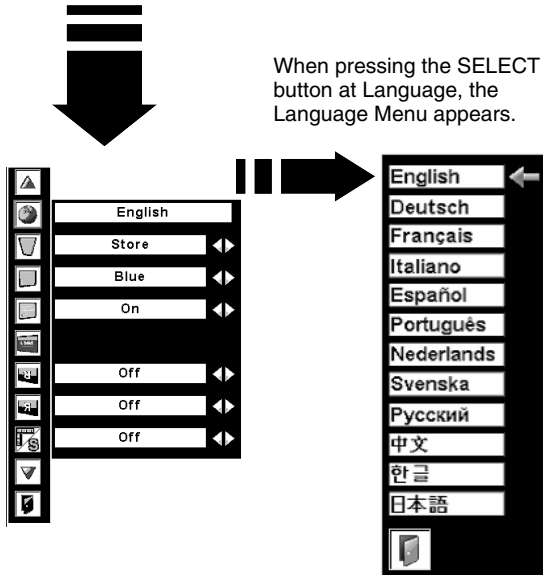
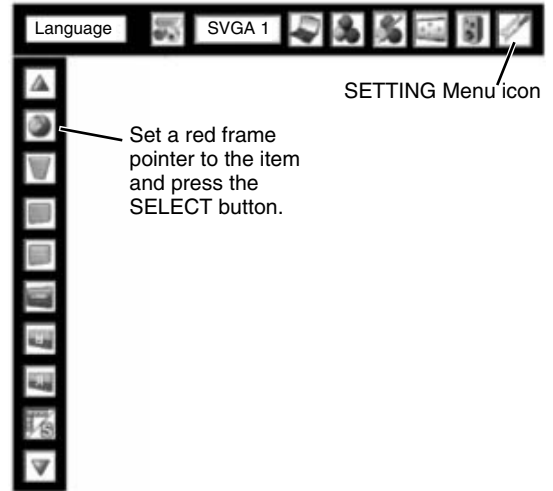



Logo

Logo settings can be altered as follows:

Logo select

This function decides what to be displayed on the starting-up display as follows:

- Offcount-down only
- Defaultthe factory-set logo
- Userthe image you captured

Capture

This function enables you to capture the image being projected and use it for a starting-up display or interval of presentations.

After capturing the projected image, go to the Logo function and set it to "User". Then the captured image can be displayed when turning on the projector next time.

To capture the image, select [Yes]. To cancel the Capture function, select [No].

NOTE;

- Before capturing an image, select Standard in the Image Select Menu to capture a proper image. (See page 29, 33.)
- A signal from a computer can be captured up to XGA (1024 X 768).
- Certain signals may not be captured properly.
- When capturing the image that has been adjusted by the Keystone function, the adjustment data is automatically reset and the projector captures an image without keystone correction.
- When starting to capture a new image, the previously stored image is cleared even if you cancel the capturing.
- Once you exit the Logo menu after setting Logo lock to "On", you are required to enter the PIN code every attempting to change the Logo setting.

Logo PIN Code Lock

This function prevents an unauthorized person from changing the Logo setting.

- Offthe Logo setting can be changed freely from the Logo menu.
- Onthe Logo setting cannot be changed without the Logo PIN code.

If you want to change the Logo PIN Code Lock setting, enter a Logo PIN code along the following steps. The initial Logo PIN code is set "4321" at the factory.

Enter a Logo PIN code

Select a number by pressing the POINT LEFT/RIGHT buttons and fix the number with the SELECT button. The number will change to "*". If you fixed a wrong number, move the pointer to "Set" or "Clear" once by pressing the POINT DOWN button, then return to "Logo PIN code". Enter the correct number again.

Repeat this step to complete entering a four-digit number.

When the four-digit number is fixed, the pointer will automatically move to "Set". Press the SELECT button so that you can change the Logo PIN code lock setting.

If you entered a wrong Logo PIN code, "Logo PIN code" and the number (****) will turn red and disappear. Enter a correct Logo PIN code all over again.

Logo

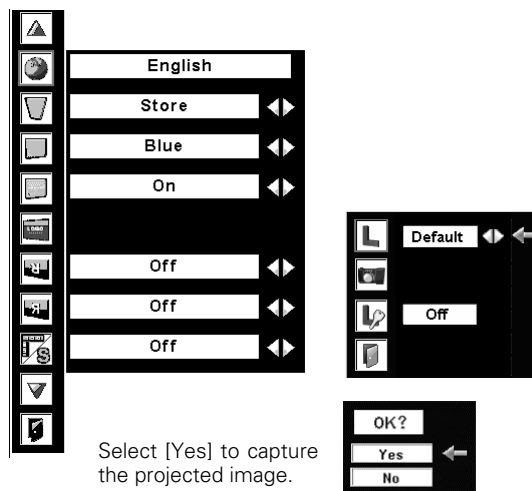

Select [Yes] to capture the projected image.

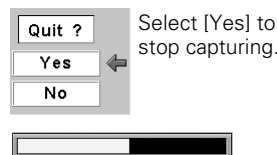

Select [Yes] to stop capturing.

Logo PIN Code Lock Dialog Box

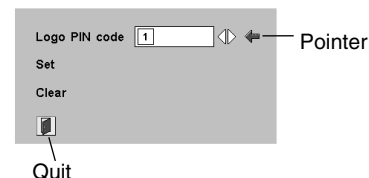

After a correct Logo PIN code is entered, the following dialog box will appear.

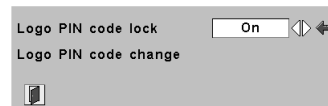

Select On/Off by pressing the POINT LEFT/RIGHT buttons or change the Logo PIN code.

Change the Logo PIN code

Logo PIN code can be changed to your desired four-digit number. Select "Logo PIN code change" with the POINT DOWN button and press the SELECT button. Set a new Logo PIN code.

Be sure to note the new Logo PIN code and keep it at hand. If you lost the number, you could no longer change the Logo PIN code setting. For details on PIN code setting, refer to relevant instructions of the PIN Code Lock function on page 42.

SETTING

Ceiling

When this function is "On," the picture is top/bottom and left/right reversed. This function is used to project the image from a ceiling mounting the projector.

Rear

When this function is "On," the picture is left/right reversed. This function is used to project the image to a rear projection screen.

Simple menu

When this function is "On," the value adjustment bar in the picture image adjustment menu is displayed on the bottom left of the screen.

Power management

For reducing power consumption as well as maintaining the lamp life, the Power Management function turns off the projection lamp when the input signal is interrupted and no button is pressed for 30 seconds or more.

If the input signal is interrupted and no button is pressed for 30 seconds or more, the timer display with the message "No signal" appears on the screen. The count-down of the set time will get started. The count-down time can be set between 1 and 30 minutes.

When the count-down time has been elapsed, the lamp will be turned off to cool itself down. The READY indicator will be switched off during this cooling-off period. The next operation depends on the setting as follows :

- ReadyWhen the lamp has been fully cooled down, the READY indicator starts flashing. In this condition, the projection lamp will be turned on if the input signal is reconnected or any button on the top control or remote control unit is pressed.
- ShutdownWhen the lamp has been fully cooled down, the power will be turned off.
- OffThe Power Management function is canceled.

On start



When this function is "On," the projector is automatically turned on just by connecting the AC power cord to a wall outlet.

NOTE;

Be sure to turn the projector off properly (see "Turning Off the Projector" on page 21). If the projector is turned off in the incorrect sequence, such as disconnecting the AC power cord before completing the cool down etc., the On start function does not operate properly.

Lamp control

This function allows you to change brightness of the screen.

-  brightness according with the input signal.
-  normal brightness.
-  lower brightness reduces the lamp power consumption and extends the lamp life.

NOTE;

This function available on models PLV-80 and PLV-80L.

Ceiling

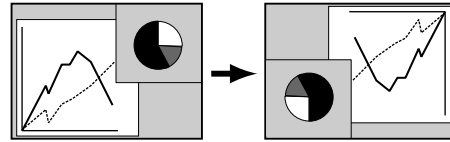

Rear

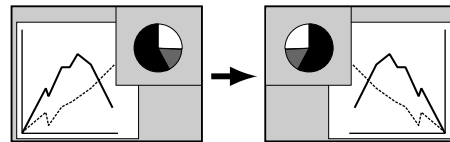

Time left until Lamp off

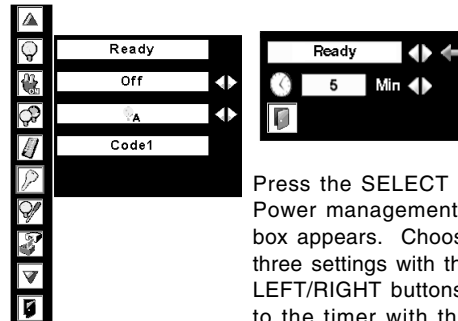

Press the SELECT button at Power management and this box appears. Choose one of three settings with the POINT LEFT/RIGHT buttons, and go to the timer with the POINT DOWN button and set time with the POINT LEFT/RIGHT buttons.

 **Remote control**

This projector provides eight different remote control codes (Code 1-Code 8); the factory-set, initial code (Code 1) and the other seven codes (Code 2 to Code 8). This switching function prevents remote control interference when operating several projectors or video equipment at the same time.

For example operating the projector in "Code 7", both the projector and the remote control must be switched to "Code 7".

To change the code for the projector:

Select a remote control code in this Setting Menu.

To change the code for the remote control:

Check the Reset Switch to "Use position" in the compartment lid on back of the remote control.

And then while holding down the MENU button, press the IMAGE button number of times corresponding to the remote control code for the projector.

To reset the code for the remote control:

Slide the Reset Switch to "Reset position" in the compartment lid on back of the remote control.

Remote control

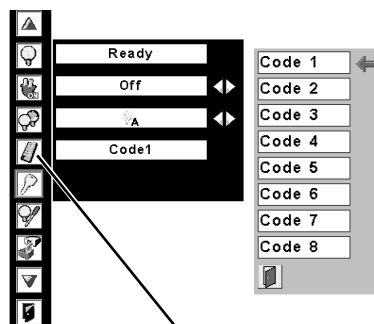

When pressing the SELECT button at Remote control, the remote control code menu appears.

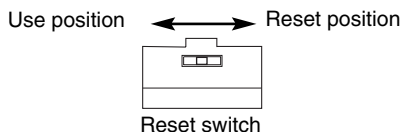



 **Security**

Key lock

This function locks operation of the top control and remote control. It is useful to prevent operation by an unauthorized person.

 not locked.

 locks operation of the top control. To unlock, use the remote control.

 locks operation of the remote control. To unlock, use the top control.

If the top control accidentally becomes locked and you do not have the remote control nearby, disconnect the AC power cord from the AC outlet, and then with pressing the SELECT button, reinsert the AC power cord. This will cancel the top control lock.

Security

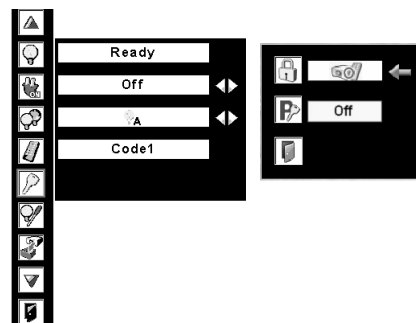

Key lock

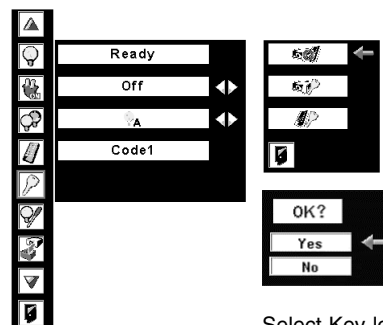

Select Key lock and this box appears. Choose one of these with the POINT UP/DOWN buttons and select [Yes] to activate it.

PIN code lock

This function prevents the projector from being operated by an unauthorized person and provides the following settings for security options.

- Offthe projector is not locked with the PIN code.
- On1requires to enter the PIN code every time turning on the projector.
- On2requires to enter the PIN code to operate the projector once the power cord is disconnected; as long as the AC power cord is connected, the projector can be operated without the PIN code.

Whenever to change the PIN Code Lock setting or the PIN code (the four-digit number), you are required to enter the PIN code. "1234" is set as the initial PIN code at the factory.

Enter a PIN code

Select a number by pressing the POINT LEFT/RIGHT buttons and fix the number with the SELECT button. The number will change to "*". If you fixed a wrong number, move the pointer to "Set" or "Clear" once by pressing the POINT DOWN button, then return to "PIN code". Enter the correct number again. Repeat this step to complete entering a four-digit number.

When the four-digit number is fixed, the pointer will automatically move to "Set". Press the SELECT button so that you can change the following PIN code lock settings.

If you entered a wrong PIN code, "PIN code" and the number (****) will turn red and disappear. Enter a correct PIN code all over again.

To Change the PIN Code Lock setting

Select Off, On1, or On2 with the POINT LEFT/RIGHT buttons and then "Quit" with the POINT DOWN button and press the SELECT button to close the dialog box.

To Change the PIN Code

The PIN code can be changed to your desired four-digit number. Select "PIN code change" with the POINT DOWN button, and press the SELECT button. The New PIN code input dialog box will appear.

Select a number with the POINT LEFT/RIGHT buttons and fix the number with the SELECT button. Repeat it to complete entering a four-digit number. When the four-digit number is fixed, the pointer will automatically move to "Set". Then press the SELECT button.

CAUTION:
WHEN YOU HAVE CHANGED PIN CODE, WRITE DOWN THE NEW PIN CODE IN COLUMN OF THE PIN CODE NO. MEMO ON PAGE 59, AND KEEP IT SECURELY. SHOULD THE PIN CODE BE LOST OR FORGOTTEN, THE PROJECTOR CAN NO LONGER BE OPERATED.

PIN code lock

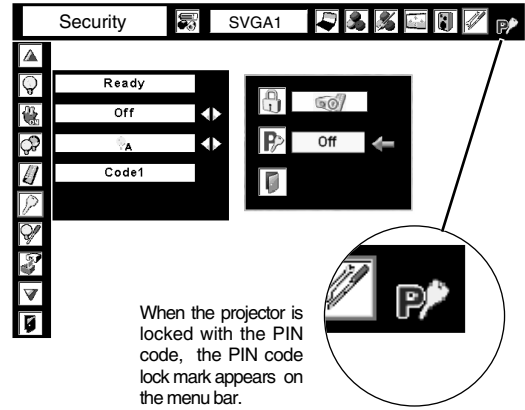

Enter a PIN code



The input numbers change to "*" for security.



When the pointer automatically move to "Set", press the SELECT button.

Change the PIN Code Lock setting



Select a desired setting with the POINT LEFT/RIGHT buttons.

Change the PIN code



Select PIN code change and press the SELECT button. The New PIN code input dialog box will appear.

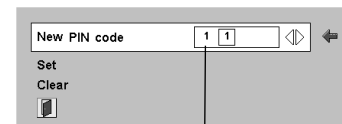

The input numbers are being displayed for confirmation.

 **Lamp counter**

This function is used to reset the lamp replace counter. When replacing the projection lamp, reset the lamp replace counter by using this function. See page 47 for operation.

 **Factory default**

This function returns all setting values except for the user logo, Key lock, PIN code lock, logo PIN code lock and the lamp counter to the factory default settings.

Factory default

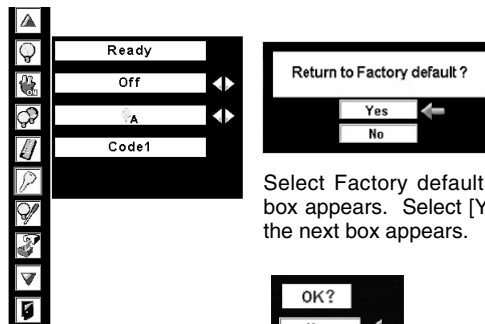

Select Factory default and this box appears. Select [Yes] , and the next box appears.

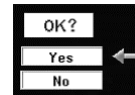

Select [Yes] to activate it.

MAINTENANCE

WARNING TEMP. INDICATOR

The Warning Temp. Indicator flashes red to let you know the internal temperature of the projector exceeds the normal level. If the temperature goes up further, the projector will be turned off automatically and the Ready indicator will go out. (The Warning Temp. Indicator continues flashing.) After the cooling-off period, the Ready Indicator lights on again and the projector can be turned on by pressing the On/Off button on the remote control unit or on the top control. When you turn on the projector, the Warning Temp. Indicator will go out.

If the Warning Temp. Indicator is still flashing, check the followings;

- 1** Ventilation Slots of a projector may be blocked. In such an event, reposition a projector so that Ventilation Slots are not obstructed.
- 2** Air Filter may be clogged with dust particles. Clean Air Filter by following section AIR FILTER CARE AND CLEANING on next page.
- 3** If WARNING TEMP. Indicator remains on after performing above checks, Cooling Fans or Internal Circuits may be malfunctioning. Contact the service station.

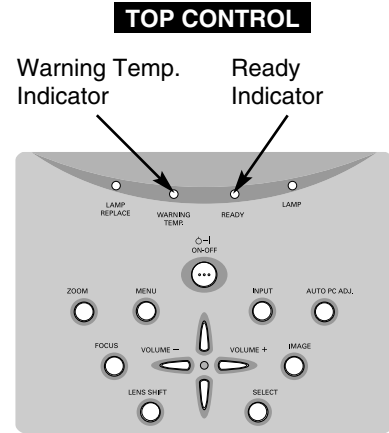

When both of the Warning Temp. and Ready indicators are flashing:

When the projector detects an internal problem, it will shut down automatically and both of the Warning temp. and Ready Indicators start flashing. In this condition, the projector cannot be turned on even if you press the On/Off button on the remote control unit or on the top control. If this case happens, disconnect and reconnect the AC power cord, and then turn on the projector again to check its operation. If the projector shuts down again or fails to be turned on, the internal check and repair will be required. Plug off the AC power cord and contact service station.

AIR FILTER CARE AND CLEANING

Air Filter prevents dust from accumulating on surface of Projection Lens and Projection Mirror. Should Air Filter become clogged with dust particles, it will reduce Cooling Fans' effectiveness and may result in internal heat build up and adversely affect life of a projector. Clean Air Filter following steps below:

- 1** Turn off a projector, and disconnect AC power cord from AC outlet.
- 2** Turn a projector upside down and remove Air Filter (2 used) by pulling latches upward.
- 3** Clean Air Filter with a brush or wash out dust and particles.
- 4** Replace Air Filter properly. Make sure that Air Filter is fully inserted.



CAUTION

Do not operate a projector with Air Filter removed. Dust may accumulate on LCD Panel and Projection Mirror degrading picture quality.

Do not put small parts into Air Intake Vents. It may result in malfunction of a projector.

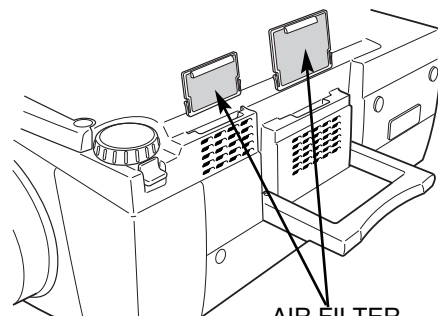

AIR FILTER
Pull up and remove.

RECOMMENDATION

We recommend avoiding dusty/smoky environments when operating a projector. Usage in these environments may cause poor image quality.

When using under dusty or smoky conditions, dust may accumulate on a lens, liquid crystal panels, or optical elements inside a projector. This condition may degrade quality of a projected image.

When above symptoms are noticed, contact your authorized dealer or service station for proper cleaning.

CLEANING PROJECTION LENS

Follow these steps to clean Projection Lens:

- 1** Turn off a projector, and disconnect AC power cord from AC outlet.
- 2** Apply a non-abrasive camera lens cleaner to a soft, dry cleaning cloth. Avoid using an excessive amount of cleaner. Abrasive cleaners, solvents or other harsh chemicals might scratch a surface.
- 3** Lightly wipe a cleaning cloth over Projection Lens.
- 4** When a projector is not in use, replace Lens Cover.

LAMP REPLACEMENT

LAMP REPLACE

When the life of the Projection Lamp of this projector draws to an end, the LAMP REPLACE indicator lights yellow. If this indicator lights yellow, replace the projection lamp with a new one promptly.

This indicator lights yellow when the life of the projection lamp draws to an end. Replace the Projection Lamp with a new one promptly.

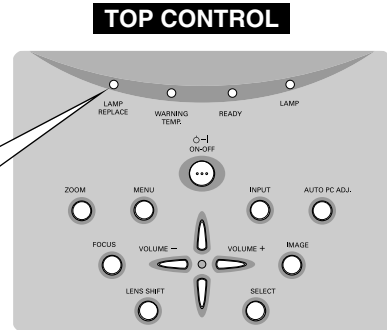

Allow a projector to cool, for at least 45 minutes before you open Lamp Cover. The inside of a projector can become very hot.



CAUTION

For continued safety, replace with a lamp assembly of the same type. Do not drop a lamp assembly or touch a glass bulb! The glass can shatter and may cause injury.

Follow these steps to replace lamp assembly.

- 1** Turn off a projector and disconnect AC plug. Allow a projector to cool for at least 45 minutes.
- 2** Loosen 2 screws with a screwdriver and open Lamp Cover.
- 3** Loosen 2 screws with a screwdriver and pull out Lamp Assembly by grasping Handle.
- 4** Replace Lamp Assembly with a new one and tighten 2 screws back. Make sure that Lamp Assembly is set properly. Replace Lamp Cover and tighten 2 screws.
- 5** Connect AC Power Cord to a projector and turn it on.
- 6** Reset Lamp Replace Counter (refer to next page "LAMP REPLACE COUNTER" section).

NOTE : Do not reset Lamp Replace Counter when Projection Lamp is not replaced.

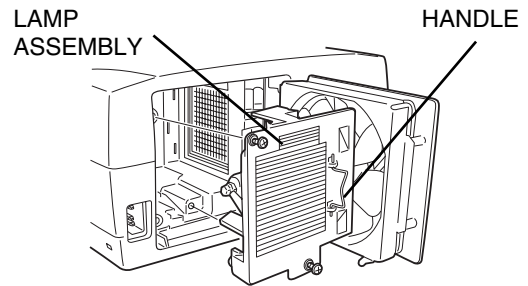
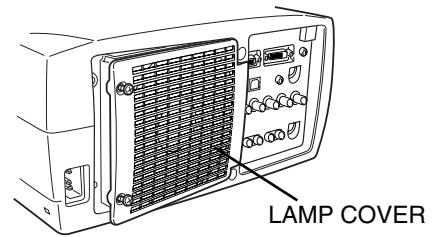

ORDER REPLACEMENT LAMP

Replacement Lamp can be ordered through your dealer. When ordering a Projection Lamp, give the following information to the dealer.

- **Model No. of your projector** : **PLV-75/PLV-75L/PLV-80/PLV-80L**
- **Replacement Lamp Type No.** : **POA-LMP99 (for PLV-75/PLV-75L)**
(Service Parts No. 610 325 2940)
- **Replacement Lamp Type No.** : **POA-LMP98 (for PLV-80/PLV-80L)**
(Service Parts No. 610 325 2957)

LAMP REPLACE COUNTER

Be sure to reset the Lamp Replace Counter after the Lamp Assembly is replaced. When the Lamp Replace Counter is reset, the LAMP REPLACE Indicator stops lighting.

- 1 Turn projector on, press MENU button and ON-SCREEN MENU will appear. Press POINT LEFT/RIGHT buttons to move a red frame pointer to SETTING Menu icon (refer to page 43).
- 2 Press POINT UP/DOWN buttons to move a red frame pointer to "Lamp counter" and then press SELECT button. The next box appears.
- 3 Press POINT UP/DOWN buttons to select "Reset" and then press SELECT button. The message "Lamp replacement counter reset?" is displayed. Move the pointer to [Yes] and then press SELECT button.
- 4 Another confirmation dialog box appears and select [Yes] to reset Lamp Replace Counter.

Lamp counter

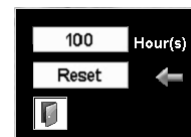
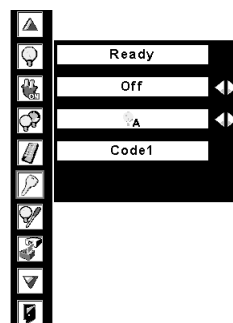

Select Lamp counter and this box appears. Select [Reset], and the next box appears.

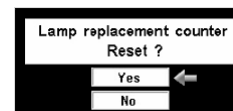

Select [Yes] and the next box appears.

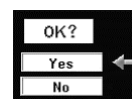

Select [Yes] to activate it.

NOTE : Do not reset the Lamp Replace Counter until after the Projection Lamp is replaced.



LAMP HANDLING PRECAUTIONS

This projector uses a high-pressure lamp which must be handled carefully and properly. Improper handling may result in accidents, injury, or create a fire hazard.

- Lamp lifetime may differ from lamp to lamp and according to the environment of use. There is no guarantee of the same lifetime for each lamp. Some lamps may fail or terminate their lifetime in a shorter period of time than other similar lamps.
- If the projector indicates that the lamp should be replaced, i.e., if the LAMP REPLACE INDICATOR lights up, replace the lamp with a new one IMMEDIATELY after the projector has cooled down. (Follow carefully the instructions in the LAMP REPLACEMENT section of this manual.) Continuous use of the lamp with the LAMP REPLACE INDICATOR lighted may increase the risk of lamp explosion.
- A Lamp may explode as a result of vibration, shock or degradation as a result of hours of use as its lifetime draws to an end. Risk of explosion may differ according to the environment or conditions in which the projector and lamp are being used.

IF A LAMP EXPLODES, THE FOLLOWING SAFETY PRECAUTIONS SHOULD BE TAKEN.

If a lamp explodes, disconnect the projector's AC plug from the AC outlet immediately. Contact an authorized service station for a checkup of the unit and replacement of the lamp. Additionally, check carefully to ensure that there are no broken shards or pieces of glass around the projector or coming out from the cooling air circulation holes. Any broken shards found should be cleaned up carefully. No one should check the inside of the projector except those who are authorized trained technicians and who are familiar with projector service. Inappropriate attempts to service the unit by anyone, especially those who are not appropriately trained to do so, may result in an accident or injury caused by pieces of broken glass.

TROUBLESHOOTING

Before calling your dealer or service center for assistance, check matters below once again.

1. Make sure you have connected a projector to your computer or video equipment as described in section "CONNECTING PROJECTOR" on pages 12 ~ 14.
2. Check cable connection. Verify that all computer, video and power cord are properly connected.
3. Verify that all power is switched on.
4. If a projector still does not produce an image, re-start your computer.
5. If an image still does not appear, unplug a projector from your computer and check your computer monitor's display. Problem may be with your graphics controller rather than with a projector. (When you reconnect a projector, be sure to turn computer and monitor off before you power up a projector. Power equipment back on in order of : Projector and computer.)
6. If problem still exists, check following chart.

Problem:	Try these Solutions
No power.	<ul style="list-style-type: none"> ● Plug a projector into your AC outlet. ● Make sure READY Indicator lights. ● Wait 90 seconds after a projector is turned OFF when turning a projector back on. <p>NOTE : After pressing Power ON-OFF button to OFF, make sure a projector works as follows:</p> <ol style="list-style-type: none"> 1. LAMP indicator lights bright and READY indicator turns off. 2. After 90 seconds, READY indicator lights green again and a projector may be turned on by pressing Power ON-OFF button. <ul style="list-style-type: none"> ● Check WARNING TEMP. and READY indicator. If both WARNING TEMP. and READY indicator flashes, a projector cannot be turned on. (See "TURNING ON/OFF PROJECTOR" section on pages 20-21.) ● Check Projection Lamp. (Refer to page 46.)
Image is out of focus.	<ul style="list-style-type: none"> ● Adjust focus of a projector. ● Make sure a projection screen is at least 5.0' (1.5m) from a projector. ● Check Projection Lens to see if it needs cleaning. <p>NOTE : Moving a projector from a cool temperature location to a warm temperature location may result in moisture condensation on Projection Lens. In such an event, leave a projector OFF and wait until condensation disappears.</p>
Picture is Left/Right reversed.	<ul style="list-style-type: none"> ● Check Ceiling/Rear feature. (See "SETTING" section on page 40.)
Picture is Top/Bottom reversed.	<ul style="list-style-type: none"> ● Check Ceiling feature. (See "SETTING" section on page 40.)
Some displays are not seen during Operation.	<ul style="list-style-type: none"> ● Check Display feature.(See "SETTING" section on page 38.)
No image.	<ul style="list-style-type: none"> ● Check connection between your computer or video equipment and a projector. ● When turning a projector on, it takes about 20 ~ 30 seconds to display an image. ● Check system that you select is corresponding with your computer or video equipment. ● Make sure temperature is not out of Operating Temperature 41 °F ~ 95 °F (5 °C ~ 35 °C).
No sound.	<ul style="list-style-type: none"> ● Check audio cable connection from audio input source. ● Adjust audio source. ● Press VOLUME (+) button. ● Press MUTE button.

Problem:	Try these Solutions
Remote Control Unit does not work.	<ul style="list-style-type: none"> ● Check batteries. ● Make sure nothing is between Infrared Remote Receiver and Remote Control Unit. ● Make sure you are not too far from a projector when using Remote Control Unit. Maximum operating range is 16.4' (5m). ● Check remote control code from Remote Control Unit. (See "SETTING" section on page 41.)

SERVICE

WARNING: High voltages are used to operate this projector. Do not attempt to open cabinet.

You can often correct operating problems yourself. If a projector fails to work properly, see "TROUBLESHOOTING" section on pages 48, 49. To correct failure, try "Solutions".

If after following all operating instructions, you find that service is necessary, contact Sanyo Service Station or store where you purchased unit.

Give model number and explain difficulty. We will advise you how to obtain service.



This symbol on the nameplate means the product is Listed by Underwriters Laboratories Inc. It is designed and manufactured to meet rigid U.L. safety standards against risk of fire, casualty and electrical hazards.



The CE Mark is a Directive conformity mark of the European Community (EC).



Pixelworks ICs used.

MENU TREE

Computer Input/Video Input

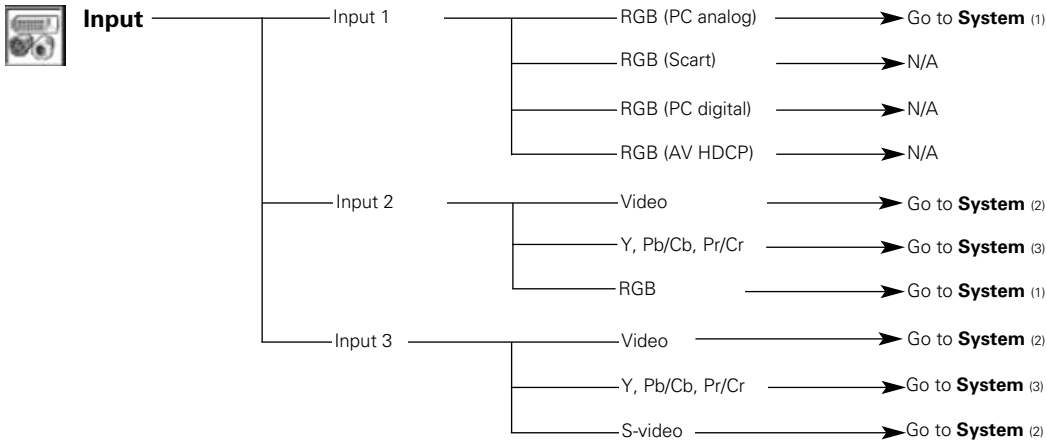

*N/A --- not applicable

Computer Input

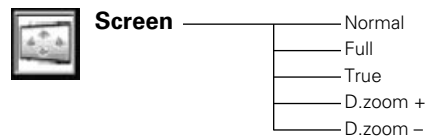
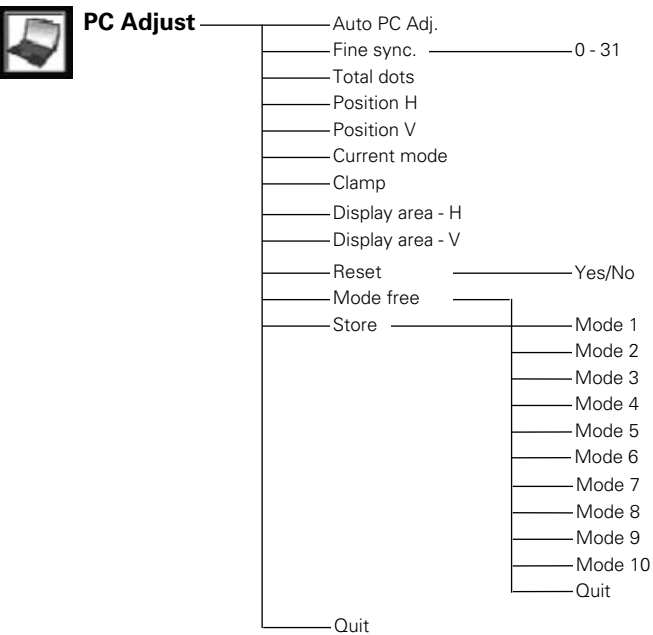
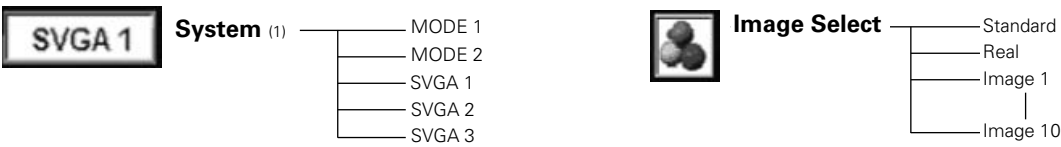

Video Input

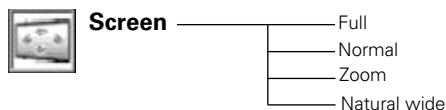
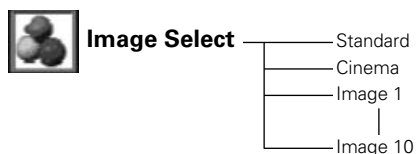
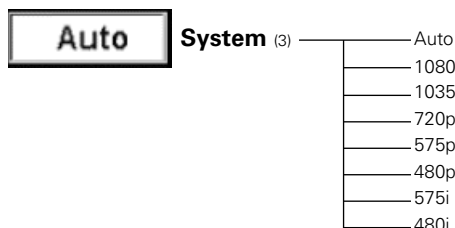
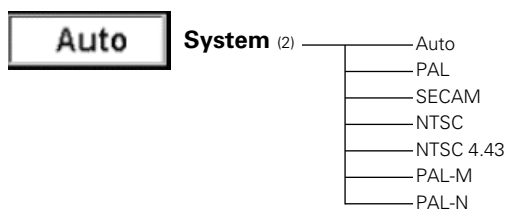

Computer Input/Video Input

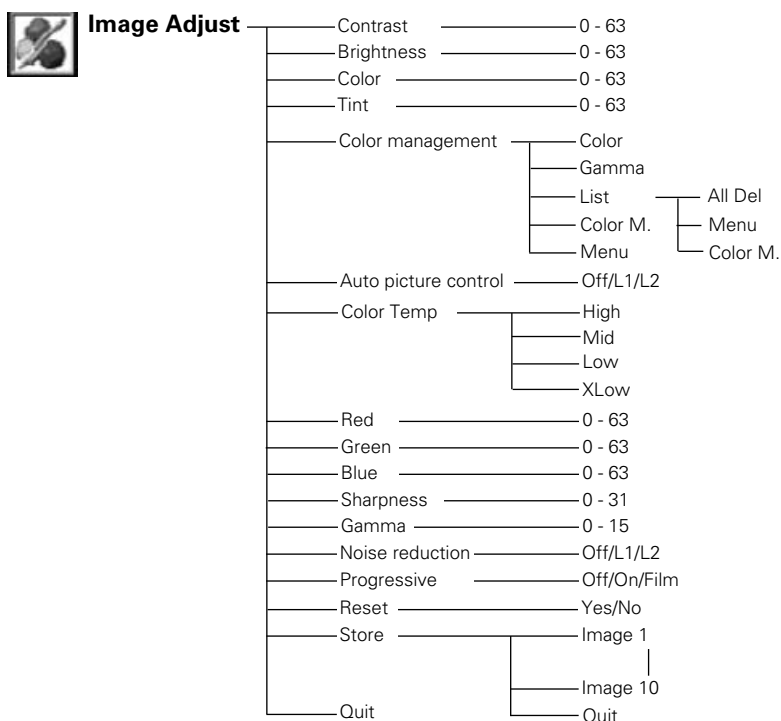

Computer Input/Video Input

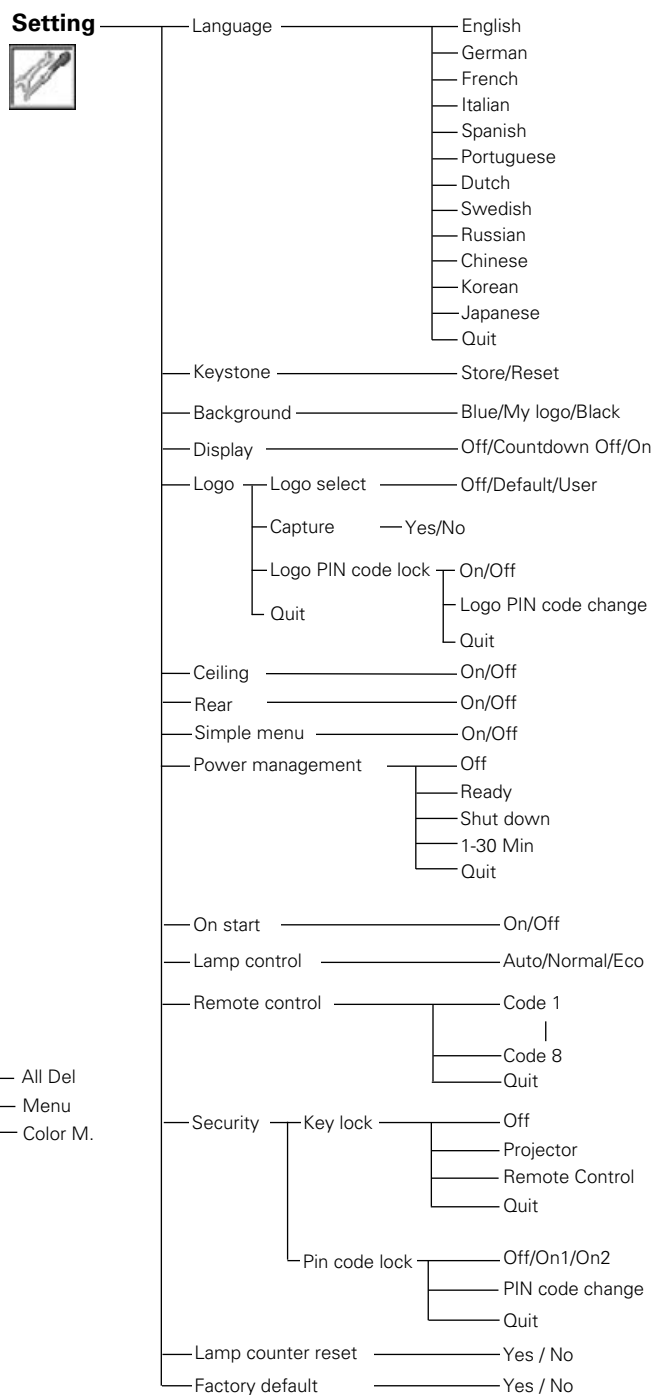

COMPATIBLE COMPUTER SPECIFICATIONS

Basically this projector can accept a signal from all computers with V, H-Frequency mentioned below and less than 140 MHz of Dot Clock.

ON-SCREEN DISPLAY	RESOLUTION	H-Freq. (kHz)	V-Freq. (Hz)	ON-SCREEN DISPLAY	RESOLUTION	H-Freq. (kHz)	V-Freq. (Hz)
VGA 1	640 x 480	31.47	59.88	MAC 19	1024 x 768	60.24	75.08
VGA 2	720 x 400	31.47	70.09	MAC 21	1152 x 870	68.68	75.06
VGA 3	640 x 400	31.47	70.09	SXGA 1	1152 x 864	64.20	70.40
VGA 4	640 x 480	37.86	74.38	SXGA 2	1280 x 1024	62.50	58.60
VGA 5	640 x 480	37.86	72.81	SXGA 3	1280 x 1024	63.90	60.00
VGA 6	640 x 480	37.50	75.00	SXGA 4	1280 x 1024	63.34	59.98
VGA 7	640 x 480	43.269	85.00	SXGA 5	1280 x 1024	63.74	60.01
MAC LC13	640 x 480	34.97	66.60	SXGA 6	1280 x 1024	71.69	67.19
MAC 13	640 x 480	35.00	66.67	SXGA 7	1280 x 1024	81.13	76.107
480i	(Interlace)	15.734	60.00	SXGA 8	1280 x 1024	63.98	60.02
575i	(Interlace)	15.625	50.00	SXGA 9	1280 x 1024	79.976	75.025
480p	(Progressive)	31.47	59.88	SXGA 10	1280 x 960	60.00	60.00
575p	(Progressive)	31.25	50.00	SXGA 11	1152 x 900	61.20	65.20
SVGA 1	800 x 600	35.156	56.25	SXGA 12	1152 x 900	71.40	75.60
SVGA 2	800 x 600	37.88	60.32	SXGA 13	1280 x 1024 (Interlace)	50.00	86.00
SVGA 3	800 x 600	46.875	75.00	SXGA 14	1280 x 1024 (Interlace)	50.00	94.00
SVGA 4	800 x 600	53.674	85.06	SXGA 15	1280 x 1024	63.37	60.01
SVGA 5	800 x 600	48.08	72.19	SXGA 16	1280 x 1024	76.97	72.00
SVGA 6	800 x 600	37.90	61.03	SXGA 17	1152 x 900	61.85	66.00
SVGA 7	800 x 600	34.50	55.38	SXGA 18	1280 x 1024 (Interlace)	46.43	86.70
SVGA 8	800 x 600	38.00	60.51	SXGA 19	1280 x 1024	63.79	60.18
SVGA 9	800 x 600	38.60	60.31	SXGA 20	1280 x 1024	91.146	85.024
SVGA 10	800 x 600	32.70	51.09	SXGA+ 1	1400 x 1050	63.97	60.19
SVGA 11	800 x 600	38.00	60.51	SXGA+ 2	1400 x 1050	65.35	60.12
MAC 16	832 x 624	49.72	74.55	SXGA+ 3	1400 x 1050	65.12	59.90
XGA 1	1024 x 768	48.36	60.00	MAC	1280 x 960	75.00	75.08
XGA 2	1024 x 768	68.677	84.997	MAC	1280 x 1024	80.00	75.08
XGA 3	1024 x 768	60.023	75.03	WXGA 1	1366 x 768	48.36	60.00
XGA 4	1024 x 768	56.476	70.07	WXGA 2	1360 x 768	47.70	60.00
XGA 5	1024 x 768	60.31	74.92	WXGA 3	1376 x 768	48.36	60.00
XGA 6	1024 x 768	48.50	60.02	WXGA 4	1360 x 768	56.16	72.00
XGA 7	1024 x 768	44.00	54.58	UXGA1	1600 x 1200	75.00	60.00
XGA 8	1024 x 768	63.48	79.35	UXGA2	1600 x 1200	81.25	65.00
XGA 9	1024 x 768 (Interlace)	36.00	87.17	UXGA3	1600 x 1200	87.50	70.00
XGA 10	1024 x 768	62.04	77.07	UXGA4	1600 x 1200	93.75	75.00
XGA 11	1024 x 768	61.00	75.70	720p	(Progressive)	45.00	60.00
XGA 12	1024 x 768 (Interlace)	35.522	86.96	720p	(Progressive)	37.50	50.00
XGA 13	1024 x 768	46.90	58.20	1035i	(Interlace)	33.75	60.00
XGA 14	1024 x 768	47.00	58.30	1080i	(Interlace)	33.75	60.00
XGA15	1024 x 768	58.03	72.00	1080i	(Interlace)	28.125	50.00

When a input signal is digital from DVI terminal, refer to chart below.

ON-SCREEN DISPLAY	RESOLUTION	H-Freq. (kHz)	V-Freq. (Hz)		ON-SCREEN DISPLAY	RESOLUTION	H-Freq. (kHz)	V-Freq. (Hz)
D-VGA	640 x 480	31.47	59.94	*	D-SXGA2	1280 x 1024	60.276	58.069
D-480p	720 x 480 (Progressive)	31.47	59.88	*	D-SXGA+	1400 x 1050	63.97	60.19
D-575p	768 x 575 (Progressive)	31.25	50.00		D-720p	1280 x 720 (Progressive)	45.00	60.00
D-SVGA	800 x 600	37.879	60.32		D-720p	1280 x 720 (Progressive)	37.50	50.00
D-XGA	1024 x 768	43.363	60.00		D-1035i	1920 x 1035 (Interlace)	33.75	60.00
D-WXGA1	1366 x 768	48.36	60.00		D-1080i	1920 x 1080 (Interlace)	33.75	60.00
D-WXGA2	1360 x 768	47.70	60.00		D-1080i	1920 x 1080 (Interlace)	28.125	50.00
D-WXGA3	1376 x 768	48.36	60.00		D-1080psf/30	1920 x 1080	33.75	60.00
D-WXGA5	1368 x 768	46.50	50.00		D-1080psf/25	1920 x 1080	28.125	50.00
* D-SXGA1	1280 x 1024	63.98	60.02		D-1080psf/24	1920 x 1080	27.00	48.00

* Depending on the condition of signals and the type and length of cables, these signals may not be properly viewed.

NOTE : Specifications are subject to change without notice.

INDICATORS AND PROJECTOR CONDITION

Check the Indicators for projector condition.

Indicators				Projector Condition
LAMP REPLACE yellow	WARNING TEMP. red	READY green	LAMP red	
●	●	●	●	The projector is OFF. (The AC Power Cord is unplugged.)
*	●	○	○	The projector is READY to be turned on with the POWER ON-OFF button.
*	●	○	●	The projector is operating normally.
*	⦿	●	○	The Warning Temp. Indicator flashes red to let you know the internal temperature of the projector exceeds the normal level. If the temperature goes up further, the projector will be turned off automatically and the Ready indicator will go out. When the projector is cooled down enough and the temperature returns to normal, the READY indicator lights green and the projector can be turned on. (The WARNING TEMP. indicator keeps flashing.) Check and clean the Air Filter.
*	⦿	○	○	The projector is cooled down enough and the temperature returns to normal. When turning on the projector, the WARNING TEMP. indicator stops flashing. Check and clean the Air Filter.

○ ●●● on ⦿ ●●● flashing ●●● dim ●●● off

Indicators				Projector Condition
LAMP REPLACE yellow	WARNING TEMP. red	READY green	LAMP red	
*	●	●	○	The projector is being cooled down. It cannot be turned on until the READY indicator lights green.
⦿	⦿	⦿	○	The projector detects an abnormal condition and cannot be turned on. Unplug the AC Power Cord and plug it again to turn on the projector. If the projector is turned off again, disconnect the AC Power Cord and contact the dealer or the service center for service and checkup. Do not leave the projector on. It may cause electric shock or a fire hazard.
*	●	⦿	●	The projector is in the Power management mode.
*	⦿	○	●	The temperature inside the projector is abnormally high.
*	⦿	●	○	The temperature inside the projector is abnormally high. The projector cannot be turned on. When the projector is cooled down enough and the temperature returns to normal, the READY indicator lights green and the projector can be turned on.
⦿	●	●	○	The lamp cannot light up. (The projector is preparing for stand-by or the projection lamp is being cooled down. The projector cannot be turned on until cooling is completed.)
⦿	●	○	○	The lamp cannot light up. (The lamp has been cooled down enough and the projector is in stand-by mode and ready to be turned on with the POWER ON-OFF button.)
○	*	●	●	The life of the projection lamp draws to an end. Replace the lamp and then reset the Lamp time. The indicator will turn off.

○ ... on ⦿ ... flashing ● ... dim ● ... off

* When the life of the projection lamp draws to an end, the LAMP REPLACE indicator lights yellow. When this indicator lights yellow, replace the projection lamp with a new one promptly. Reset the Lamp Replace Counter after replacement of the lamp.

TECHNICAL SPECIFICATIONS

Projector Type	Multi-media Projector
Dimensions (W x H x D)	12.6" x 6.6" x 16.8" (319 mm x 168 mm x 429.5 mm)
Net Weight	19.2 lbs (8.7 kg) PLV-75/PLV-80, 16.3 lbs (7.4 kg) PLV-75L/PLV-80L
LCD Panel System	1.21" TFT Active Matrix type, 3 panels
Panel Resolution	1366 x 768 dots
Number of Pixels	3,147,264 (1366 x 768 x 3 panels)
Color System	PAL, SECAM, NTSC, NTSC4.43, PAL-M and PAL-N
High Definition TV Signal	480i, 480p, 575i, 575p, 720p, 1035i and 1080i
Scanning Frequency	H-sync. 15 ~ 100 KHz, V-sync. 48 ~ 100 Hz
Projection Lens	F1.8 ~ 2.1 lens with f=48.4 mm ~ 62.8 mm Motor zoom and focus
Throw distance	5.0' (1.5 m) ~ 52.2' (15.9 m)
Motorized Lens Shift	Up and Down
Projection Image Size (Diagonal)	Adjustable from 30" to 400"
Horizontal Resolution	800 TV lines (HDTV)
Projection Lamp	300 watt type (PLV-80/PLV-80L), 200 watt type (PLV-75/PLV-75L)
Input 1 Jacks	DVI Terminal (Digital) HDCP Compatible, HDB 15-pin Terminal (Analog) and Stereo Mini Type Jack (Audio)
Input 2 Jacks	BNC Type x 5 (G or VIDEO/Y, B or Cb/Pb, R or Cr/Pr, H and V), Stereo Mini Type Jack (Audio)
Input 3 Jacks	RCA Type x 3 (VIDEO/Y, Cb/Pb and Cr/Pr), RCA Type x 2 (Audio R and L) and DIN 4-pin (S-Video)
Other Jacks	DIN 8-pin (Control port), Wired Remote Jack and PJ-Net Organizer Connector
Built-in Speakers	INT. SP. Stereo (R and L), 2 watt RMS (T.H.D. 10%)
Feet Adjustment	0° to 10.5°
Voltage and Power Consumption (PLV-75/PLV-75L)	AC 100 ~ 120 V (3.6 A Max. Ampere), 50 / 60 Hz (The U.S.A and Canada) AC 200 ~ 240 V (1.8 A Max. Ampere), 50 / 60 Hz (Continental Europe and The U.K.)
Voltage and Power Consumption (PLV-80/PLV-80L)	AC 100 ~ 120 V (5.0 A Max. Ampere), 50 / 60 Hz (The U.S.A and Canada) AC 200 ~ 240 V (2.5 A Max. Ampere), 50 / 60 Hz (Continental Europe and The U.K.)
Operating Temperature	41 °F ~ 95 °F (5 °C ~ 35 °C)
Storage Temperature	14 °F ~ 140 °F (-10 °C ~ 60 °C)
Remote Control Transmitter	Power Source : AA, UM3 or LR06 1.5V ALKALINE Type x 2 Operating Range : 16.4' (5m) / ±30° Dimensions : 1.97" x 1.06" x 6.61" (50mm x 27mm x 168mm) Net Weight : 4.4 oz (126 g) (including batteries)
Accessories	Owner's Manual AC Power Cord Wireless/Wired Remote Control Transmitter and Batteries Control Cable for Serial port Lens Cover (PLV-75/PLV-80) PIN Code Label

- Specifications are subject to change without notice.
- LCD panels are manufactured to the highest possible standards. Even though 99.99% of the pixels are effective, a tiny fraction of the pixels (0.01% or less) may be ineffective by the characteristics of the LCD panels.

PJ LINK NOTICE

This projector is compliant with PJLink Standard Class 1 of JBMA (Japan Business Machine and Information System Industries Association). This projector supports all commands defined by PJLink Class 1 and is verified conformance with PJLink Standard Class 1.

SANYO Projector Input	PJLink Input	Parameter	
INPUT-1	RGB (PC (Analog))	RGB 1	11
	RGB (Scart)	RGB 2	12
	RGB (PC Digital)	DIGITAL 1	31
	RGB (AV HDCP)	DIGITAL 2	32
INPUT-2	Video	VIDEO 1	21
	Y, Pb/Cb, Pr/Cr	VIDEO 2	22
	RGB	RGB 3	13
INPUT-3	Video	VIDEO 3	23
	Y, Pb/Cb, Pr/Cr	VIDEO 4	24
	S-video	VIDEO 5	25

PJLink is a registered trademark of JBMA.



CONFIGURATIONS OF TERMINALS

COMPUTER INPUT-1 TERMINALS (ANALOG)

Terminal : HDB15-PIN

Pin Configuration

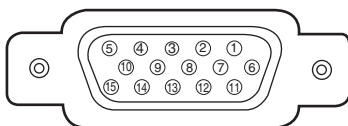

1	Red Input	9	+5V Power
2	Green Input	10	Ground (Vert.sync.)
3	Blue Input	11	Sense 0
4	Sense 2	12	DDC Data
5	Ground (Horiz.sync.)	13	Horiz. sync.
6	Ground (Red)	14	Vert. sync.
7	Ground (Green)	15	DDC Clock
8	Ground (Blue)		

COMPUTER INPUT-1 TERMINAL (DIGITAL)

Terminal : DVI 24-pin

Pin Configuration

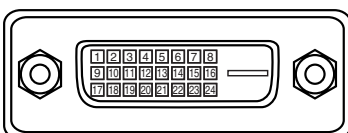

1	T.M.D.S. Data2-	9	T.M.D.S. Data1-	17	T.M.D.S. Data0-
2	T.M.D.S. Data2+	10	T.M.D.S. Data1+	18	T.M.D.S. Data0+
3	T.M.D.S. Data2 Shield	11	T.M.D.S. Data1 Shield	19	T.M.D.S. Data0 Shield
4	No Connect	12	No Connect	20	No Connect
5	No Connect	13	No Connect	21	No Connect
6	DDC Clock	14	+5V Power	22	T.M.D.S. Clock Shield
7	DDC Data	15	Ground (for +5V)	23	T.M.D.S. Clock+
8	No Connect	16	Hot Plug Detect	24	T.M.D.S. Clock-

CONTROL PORT CONNECTOR

Terminal : Mini DIN 8-PIN

Pin Configuration

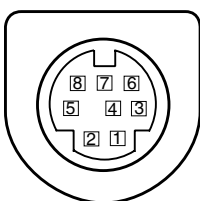

	PS/2	Serial	ADB
1	-----	R X D	-----
2	CLK	-----	ADB
3	DATA	-----	-----
4	GND	GND	GND
5	-----	RTS / CTS	-----
6	-----	T X D	-----
7	GND	GND	-----
8	-----	GND	GND

OPTIONAL PARTS

The parts listed below are optionally supplied. When ordering those parts, give the name and Type No. to the sales dealer.

- | | |
|---------------------------------|-------------------------|
| ● DVI Cable | Type No. : KA-DV20 |
| ● HDB 15 pin-SCART 21 pin Cable | Type No. : POA-CA-SCART |
| ● Long Zoom Lens | Type No. : LNS-T31A |
| ● Ultra Long Zoom Lens | Type No. : LNS-T32 |
| ● Short Zoom Lens | Type No. : LNS-W31A |
| ● Short Fixed Lens | Type No. : LNS-W32 |
| ● PJ-Net Organizer | Type No. : POA-PN40 |

LENS REPLACEMENT

The lens of this projector can be replaced with other optional lens which are sold separately. This feature enables you to use the projector for wide variety of uses.

For installation and replacement of the lens, always contact the sales dealer. The projector lens must be installed or replaced by well-trained sales or service engineers. Do not attempt to do by yourself as it may cause injury.



After installing the lens, attach the lens cap to the lens when setting up the projector.
Do not hold the lens when carrying or lifting the projector. It may cause serious damage to the projector.

PIN CODE NUMBER MEMO

Write down the PIN code number in the column below and keep it with this manual securely. If you forgot or lost the number and unable to operate the projector, contact the service station.

PIN Code Lock No.

--	--	--	--

Factory default set No: 1 2 3 4*

Logo PIN Code Lock No.

--	--	--	--

Factory default set No: 4 3 2 1*

**Should the four-digit number be changed, the factory set number will be invalid.*

While the projector is locked with the PIN code...

Put the label below (supplied) on in a prominent place of the projector's body while it is locked with a PIN code.

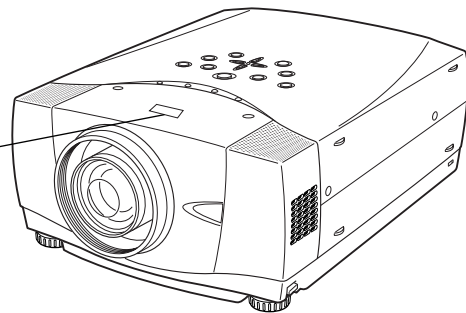

Printed in Japan
Part No. 610 324 1739 (1AA6P1P4949-- M4YA)

SANYO

SANYO Electric Co., Ltd