

# UDM



User manual

## **Product revision**

Software Revision: 2.2

**Barco Fredrikstad AS**  
Haborneveien 53, N-1630 Gamle Fredrikstad, Norway  
Support.fre@barco.com  
www.barco.com

**Barco NV**  
Beneluxpark 21, 8500 Kortrijk, Belgium  
www.barco.com/en/support  
www.barco.com

## Copyright ©

All rights reserved. No part of this document may be copied, reproduced or translated. It shall not otherwise be recorded, transmitted or stored in a retrieval system without the prior written consent of Barco.

## Changes

Barco provides this manual 'as is' without warranty of any kind, either expressed or implied, including but not limited to the implied warranties or merchantability and fitness for a particular purpose. Barco may make improvements and/or changes to the product(s) and/or the program(s) described in this publication at any time without notice.

This publication could contain technical inaccuracies or typographical errors. Changes are periodically made to the information in this publication; these changes are incorporated in new editions of this publication.

The latest edition of Barco manuals can be downloaded from the Barco web site [www.barco.com](http://www.barco.com) or from the secured Barco web site <https://www.barco.com/en/signin>.

## Trademarks

Brand and product names mentioned in this manual may be trademarks, registered trademarks or copyrights of their respective holders. All brand and product names mentioned in this manual serve as comments or examples and are not to be understood as advertising for the products or their manufacturers.

## Product Security Incident Response

As a global technology leader, Barco is committed to deliver secure solutions and services to our customers, while protecting Barco's intellectual property. When product security concerns are received, the product security incident response process will be triggered immediately. To address specific security concerns or to report security issues with Barco products, please inform us via contact details mentioned on <https://www.barco.com/psirt>. To protect our customers, Barco does not publically disclose or confirm security vulnerabilities until Barco has conducted an analysis of the product and issued fixes and/or mitigations.

## Patent protection

Please refer to [www.barco.com/about-barco/legal/patents](http://www.barco.com/about-barco/legal/patents).

## Guarantee and Compensation

Barco provides a guarantee relating to perfect manufacturing as part of the legally stipulated terms of guarantee. On receipt, the purchaser must immediately inspect all delivered goods for damage incurred during transport, as well as for material and manufacturing faults Barco must be informed immediately in writing of any complaints.

The period of guarantee begins on the date of transfer of risks, in the case of special systems and software on the date of commissioning, at latest 30 days after the transfer of risks. In the event of justified notice of complaint, Barco can repair the fault or provide a replacement at its own discretion within an appropriate period. If this measure proves to be impossible or unsuccessful, the purchaser can demand a reduction in the purchase price or cancellation of the contract. All other claims, in particular those relating to compensation for direct or indirect damage, and also damage attributed to the operation of software as well as to other services provided by Barco, being a component of the system or independent service, will be deemed invalid provided the damage is not proven to be attributed to the absence of properties guaranteed in writing or due to the intent or gross negligence or part of Barco.

If the purchaser or a third party carries out modifications or repairs on goods delivered by Barco, or if the goods are handled incorrectly, in particular if the systems are operated incorrectly or if, after the transfer of risks, the goods are subject to influences not agreed upon in the contract, all guarantee claims of the purchaser will be rendered invalid. Not included in the guarantee coverage are system failures which are attributed to programs or special electronic circuitry provided by the purchaser, e.g. interfaces. Normal wear as well as normal maintenance are not subject to the guarantee provided by Barco either.

The environmental conditions as well as the servicing and maintenance regulations specified in this manual must be complied with by the customer.

## **Disclaimer on GUI images used in this manual**

The GUI images in this manual are example illustrations and should be treated as such. While the name of the projector displayed in the illustrations may be different from the projector model you are currently using, the menu lay-out and functionality is identical.

## **Disclaimer for camera usage**

Barco provides a kit with a laser range finder and USB camera to help measure the distance from the front of the projector to the projected surface and to help monitor the performance of the projector. Barco disclaims any liability for any use of the USB camera outside this intended use.

## **Disclaimer for network usage**

Barco highly recommends to install the projector in a **closed network** environment to minimize the risk of leaking, hacking or corrupting of company confidential information; commercial sensitive information and/or personal data. Furthermore, strengthen your network security to protect the projector against unauthorized access by third parties. To the maximum extent permitted by law, Barco disclaims any liability for the use of the projector in an open network environment.

# Table of contents

<b>1</b>	<b>Safety information</b>	<b>9</b>
1.1	General Considerations	10
1.2	Important safety instructions	11
1.3	Product safety labels	15
1.4	High Brightness precautions: Hazard Distance	16
1.5	HD for fully enclosed projection systems	18
1.6	HD in function of modifying optics	19
1.7	Radio equipment (optional)	20
1.8	Compliance	20
1.9	Download Product Manual	20
<b>2</b>	<b>Getting Started</b>	<b>21</b>
2.1	Getting to know the projector	22
2.2	Power on the projector	24
2.3	Start image projection	25
2.4	Switching to ready mode	28
2.5	Power off projector	28
<b>3</b>	<b>Pulse Remote Control Unit</b>	<b>29</b>
3.1	Pulse RCU, battery installation	30
3.2	Pulse RCU, protocol setup	31
3.3	Pulse RCU, function of the on/off button	31
3.4	Using the RCU	32
3.5	Pulse RCU, Functionality overview	33
3.6	Pulse RCU, function of the “button pressed indicator”	33
3.7	Pulse RCU, function of the “RGB filter” button	34
3.8	Displaying and Programming addresses into the RCU	34
3.9	Using the XLR connector of the RCU	34
3.10	Using the mini-jack connector of the RCU	35
3.11	Pulse RCU, silicone protection sleeve (optional)	35
<b>4</b>	<b>Input &amp; Communication</b>	<b>37</b>
4.1	Introduction	38
4.2	Local Keypad and LCD panel	38
4.3	LCD touch panel	39
4.4	Communication connections	40
4.5	LED and Button indication chart	42

4.6	Pulse Quad Combo input Mk II .....	43
4.7	Pulse Quad Combo input Mk I .....	44
4.8	Pulse Quad DP 1.2 input .....	45
4.9	Pulse SFP input .....	46
<b>5</b>	<b>GUI – Introduction .....</b>	<b>47</b>
5.1	Overview .....	48
5.2	Navigation .....	51
5.3	Test Patterns .....	53
<b>6</b>	<b>GUI – Source .....</b>	<b>55</b>
6.1	Displaying a single source .....	56
6.2	Displaying multiple sources: Stitched layouts .....	56
6.3	Connector Settings .....	58
<b>7</b>	<b>GUI – Image .....</b>	<b>61</b>
7.1	Setting image levels manually .....	62
7.2	Adjusting the sharpness .....	63
7.3	Adjusting the gamma correction .....	64
7.4	Setting the desired Gamma type .....	65
7.5	Digital Shift & Zoom .....	67
7.6	RealColor P7 .....	71
7.7	Displaying HDR content .....	73
7.8	Dynamic contrast .....	74
<b>8</b>	<b>GUI – Installation .....</b>	<b>77</b>
8.1	Configuring the lens, optical zoom-focus .....	78
8.2	Configuring the lens, shift .....	78
8.3	Configuring the lens, dynamic focus .....	79
8.4	Configuring the lens, Shift to center .....	80
8.5	Configuring the lens, tilt sensor .....	81
8.6	Laser ranging .....	82
8.7	Manipulating the rigging frame .....	83
8.8	Manipulating the rigging frame, center position .....	85
8.9	Orientation .....	85
8.10	Scaling modes .....	86
8.11	Warping .....	87
8.11.1	Warping – On/Off .....	88
8.11.2	Warping – Screen Size .....	88
8.11.3	Warping – 4 corners adjustment .....	91
8.11.4	Warping – Bow .....	93
8.11.5	Warping – Warp files .....	97
8.11.6	Warping – Latency control in a multi projector setup .....	99
8.12	Blending & masking .....	100
8.12.1	Basic blend .....	101
8.12.2	Blend & Blend mask .....	103
8.12.3	Blend Files .....	105
8.12.4	Basic black level adjustment .....	106
8.12.5	RGB gain adjustment .....	108
8.12.6	Black Level Files .....	109
8.13	Illumination .....	110
8.14	3D projection .....	111
8.14.1	Active Stereo & Passive Stereo .....	111
8.14.2	Setup process 3D projection .....	112

8.14.3	Connection possibilities .....	112
8.14.4	3D Setup .....	113
<b>9</b>	<b>GUI – Profiles .....</b>	<b>115</b>
9.1	Profiles introduction .....	116
9.2	Profiles setup parameters .....	116
9.3	Saving settings to a new profile .....	117
9.4	Deleting a projector profile .....	119
<b>10</b>	<b>GUI – System Settings .....</b>	<b>121</b>
10.1	Remote control .....	122
10.1.1	Broadcast address .....	122
10.1.2	Projector address .....	122
10.1.3	IR sensors .....	123
10.2	Host name - custom projector name setup .....	124
10.3	Communication, LAN setup .....	125
10.3.1	Introduction to a Network connection .....	125
10.3.2	Wired IP address set up .....	126
10.3.3	Wireless IP address set up .....	128
10.3.4	LAN over HDBaseT™ IP address set up .....	131
10.4	DMX .....	133
10.5	Front XLR output voltage control .....	135
10.6	GSM configuration .....	135
10.7	Changing the User Interface language .....	136
10.8	Themes .....	137
10.9	Units (measurement) system setup .....	138
10.10	Controlling the backlight of the LCD Display .....	138
10.11	Date and time setup - manually .....	139
10.12	Date and time setup - automatically .....	140
10.13	Power saving settings .....	142
10.14	Lens features .....	143
10.15	Factory reset .....	144
10.16	Lens Calibration .....	148
10.17	Flex brightness .....	149
10.18	Rigging frame Calibration .....	150
10.19	Electronic Convergence .....	151
10.20	Operational mode .....	153
10.21	Capture mode .....	154
10.22	Login to advanced settings .....	154
10.23	List of open source licenses .....	155
<b>11</b>	<b>Advanced Settings .....</b>	<b>157</b>
11.1	Remote access – Enable source preview .....	158
11.2	Remote access – Enable camera preview .....	159
11.3	Advanced Settings – Color .....	160
11.4	Advanced Settings – Statistics .....	161
11.5	Checking the status of the Laser Banks .....	162
11.6	Advanced settings – Tilt sensor calibration .....	163
<b>12</b>	<b>GUI – Status menu .....</b>	<b>165</b>
12.1	Status menu overview .....	166
<b>13</b>	<b>Product maintenance .....</b>	<b>169</b>
13.1	Software update .....	170

13.2	Cleaning the lens .....	171
13.3	Cleaning the exterior of the projector.....	172
13.4	Cleaning / replace the air filters.....	172
<b>A</b>	<b>Specifications .....</b>	<b>177</b>
A.1	Specifications SDI inputs.....	178
A.2	Specifications HDMI inputs .....	178
A.3	Specifications HDBaseT inputs.....	179
A.4	Specifications DisplayPort 1.2 inputs .....	180
A.5	Specifications SFP inputs .....	181
<b>B</b>	<b>Video timing tables .....</b>	<b>183</b>
B.1	Overview video timings.....	184
B.2	Overview video timings SDI Inputs .....	185
B.3	Overview video timings HDMI 2.0 inputs .....	186
B.4	Overview video timings DisplayPort 1.2 inputs .....	188
B.5	Overview video timings HDBaseT inputs .....	190
<b>C</b>	<b>DMX chart .....</b>	<b>193</b>
C.1	DMX chart input board positioning .....	194
C.2	DMX chart, Basic .....	194
C.3	DMX chart, Extended.....	195
<b>D</b>	<b>WiFi &amp; GSM compliance information .....</b>	<b>199</b>
D.1	Compliance FCC.....	200
D.2	Compliance IC .....	200
D.3	KCC Certification.....	201
<b>E</b>	<b>Regulatory information .....</b>	<b>203</b>
E.1	Product compliance .....	204
E.2	China RoHS compliance.....	205
E.3	Taiwan RoHS compliance .....	206
E.4	Turkey RoHS compliance.....	207
E.5	Disposal information.....	207
E.6	Contact information.....	208
E.7	Production address .....	208
	<b>Glossary .....</b>	<b>209</b>
	<b>List of tools .....</b>	<b>211</b>
	<b>Index .....</b>	<b>213</b>



# Safety information

# 1

1.1	General Considerations .....	10
1.2	Important safety instructions .....	11
1.3	Product safety labels.....	15
1.4	High Brightness precautions: Hazard Distance.....	16
1.5	HD for fully enclosed projection systems.....	18
1.6	HD in function of modifying optics .....	19
1.7	Radio equipment (optional) .....	20
1.8	Compliance.....	20
1.9	Download Product Manual .....	20

## About this document

Read this document attentively. It contains important information to prevent personal injury while installing and using the UDM projector. Furthermore, it includes several cautions to prevent damage to the UDM projector. Ensure that you understand and follow all safety guidelines, safety instructions and warnings mentioned in this chapter before installing the UDM projector.

## Clarification of the term “UDM” used in this document

When referring in this document to the term “UDM” means that the content is applicable for following Barco products:

- UDM 4K15, UDM 4K22, UDM W15, UDM W19, UDM W22

## Model certification name

- UDM



Barco provides a guarantee relating to perfect manufacturing as part of the legally stipulated terms of guarantee. Observing the specification mentioned in this chapter is critical for projector performance. Neglecting this can result in loss of warranty.

## 1.1 General Considerations



**WARNING:** Be aware of suspended loads.



**WARNING:** Wear a hard hat to reduce the risk of personal injury.



**WARNING:** Be careful while working with heavy loads.



**WARNING:** Mind your fingers while working with heavy loads.



**WARNING:** In case of optical radiation emergency, please disconnect the device from the mains current; this by employing the mains switch. In case the mains switch is not easily accessible, the projectors shall be disconnected by other means for example the mains junction box. It is advised to employ the shutter or select a black image on the projector in order to reduce the risk of the emergency.

### General safety instructions

- This product contains no user serviceable parts. Attempts to modify/replace mechanics or electronics inside the housing or compartments will violate any warranties and may be hazardous.
- Do not stare into beam when the projector is on. The bright light may result in permanent eye damage.
- Before operating this equipment please read this manual thoroughly and retain it for future reference.
- Installation and preliminary adjustments must be performed by qualified Barco personnel or by authorized Barco service dealers.
- All warnings on the projector and in the documentation manuals must be adhered to.
- All instructions for operating and use of this equipment must be followed precisely.
- All local installation codes should be adhered to.

### Notice on safety

**This equipment is built in accordance with the requirements of the applicable international safety standards.** These safety standards impose important requirements on the use of safety critical components, materials and insulation, in order to protect the user or operator against risk of electric shock and energy hazard and having access to live parts. Safety standards also impose limits to the internal and external temperature rises, radiation levels, mechanical stability and strength, enclosure construction and protection against the risk of fire. Simulated single fault condition testing ensures the safety of the equipment to the user even when the equipment's normal operation fails.

### Notice on optical radiation

This projector embeds extremely high brightness (radiance) lasers; this laser light is processed through the projector's optical path. Native laser light is not accessible by the end user in any use case. The light exiting the projection lens has been diffused within the optical path, representing a larger source and lower radiance value than native laser light. Nevertheless the projected light represents a significant risk for the human eye and skin when exposed directly within the beam. This risk is not specifically related to the characteristics of laser light but solely to the high thermal induced energy of the light source; which is equivalent with lamp based systems.

Thermal retinal eye injury is possible when exposed within the Hazard Distance (HD). The HD is defined from the projection lens surface towards the position of the projected beam where the irradiance equals the maximum permissible exposure as described in the chapter "Hazard Distance".



**WARNING:** No direct exposure to the beam within the hazard distance shall be permitted, RG3 (Risk Group 3) IEC EN 62471-5:2015



**CAUTION:** Use of controls or adjustments or performance of procedures other than those specified herein may result in hazardous radiation exposure.

## Notice on laser radiation

The laser distance meter that is optional equipment for this projector can emit a class 2 laser ranging beam of 0.95 mW / 638 nm. When installed correctly, this distance meter is located on the front side of the projector (see ). The laser beam can be enabled by either pressing the button on the equipment, via the projector menu, or via the projector software. Thermal retinal eye injury is possible when staring into the laser ranging beam.

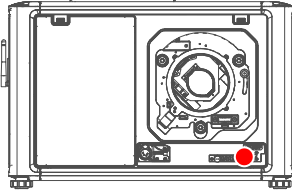

Image 1-1



**WARNING:** Laser Radiation — Do not stare into laser ranging beam, Class 2 IEC EN 60825-1:2014  
See the product safety manual for details.

## Users definition

Throughout this manual, the term SERVICE PERSONNEL refers to Barco authorized persons having appropriate technical training and experience necessary to be knowledgeable of potential hazards to which they are exposed (including, but not limited to HIGH VOLTAGE ELECTRIC and ELECTRONIC CIRCUITRY and HIGH BRIGHTNESS PROJECTORS) in performing a task, and of measures to minimize the potential risk to themselves or other persons. The term USER and OPERATOR refers to any person other than SERVICE PERSONNEL, AUTHORIZED to operate professional projection systems.

The UDM projector is intended "FOR PROFESSIONAL USE ONLY" by AUTHORIZED PERSONNEL familiar with potential hazards associated with high voltage, high intensity light beams and high temperatures generated by the light source and associated circuits. Only qualified SERVICE PERSONNEL, knowledgeable of such risks, are allowed to perform service functions inside the product enclosure.

# 1.2 Important safety instructions

## To prevent risk of electrical shock

- This product should be operated from a mono phase AC power source. Ensure that the mains voltage and capacity matches the projector electrical ratings: 120-180V / 200-240V (+/-10%), 16A-12A, 50-60Hz. If you are unable to install the AC requirements, contact your electrician. Do not defeat the purpose of the grounding.
- This apparatus must be grounded (earthed) via the supplied 3 conductor AC power cable.
- If none of the supplied power cables are the correct one, consult your dealer.
- If you are unable to insert the plug into the outlet, contact your electrician to replace your obsolete outlet. Do not defeat the purpose of the grounding-type plug.
- Never use 2- wire power cords, as this is dangerous and could lead to electrical shock. Always use a power connector with a ground terminal.
- Do not allow anything to rest on the power cord. Do not locate this product where persons will walk on the cord. To disconnect the cord, pull it out by the plug. Never pull the cord itself.
- Use only the power cord supplied with your device. While appearing to be similar, other power cords have not been safety tested at the factory and may not be used to power the device. For a replacement power cord, contact your dealer.
- If you are unable to insert the plug into the outlet, contact your electrician to replace your obsolete outlet. Do not defeat the purpose of the grounding-type plug.
- Do not operate the projector with a damaged cord. Replace the cord.
- Do not operate the projector if the projector has been dropped or damaged - until it has been examined and approved for operation by qualified service personnel.

- Position the cord so that it will not be tripped over, pulled, or contact hot surfaces.
- If an extension cord is necessary, a cord with a current rating at least equal to that of the projector should be used. A cord rated for less amperage than the projector may overheat.
- Never push objects of any kind into this product through cabinet slots as they may touch dangerous voltage points or short out parts that could result in a risk of fire or electrical shock.
- Make sure that no objects enter into the vents and openings of the set.
- Do not expose this projector to rain or moisture.
- The projector is designed for indoor use only. Never operate the unit outdoors.
- Do not immerse or expose this projector in water or other liquids.
- Do not spill liquid of any kind on this projector.
- Should any liquid or solid object fall into the cabinet, unplug the set and have it checked by qualified service personnel before resuming operations.
- Do not disassemble this projector, always take it to qualified service personnel when service or repair work is required.
- Do not use an accessory attachment which is not recommended by the manufacturer.
- Lightning - For added protection for this video product during a lightning storm, or when it is left unattended and unused for long periods of time, unplug it from the wall outlet. This will prevent damage to the device due to lightning and AC power-line surges.

### To prevent personal injury

- To prevent injury and physical damage, always read this manual and all labels on the system before powering the projector or adjusting the projector.
- To prevent injury, take note of the weight of the projector. The weight of a basic projector is about 48 kg (105 lb) without lens.
- To prevent injury, ensure that the lens and all covers are correctly installed. See installation procedures.
- **Warning:** high intensity light beam. NEVER look into the lens ! High luminance could result in damage to the eye.
- **Warning: extremely high brightness projector:** This projector embeds extremely high brightness (radiance) lasers; this laser light is processed through the projectors optical path. Native laser light is not accessible by the end user in any use case. The light exiting the projection lens has been diffused within the optical path, representing a larger source and lower radiance value than native laser light. Nevertheless the projected light represents a significant risk for the human eye when exposed directly within the beam. This risk is not specific related to the characteristics of laser light but solely to the high thermal induced energy of the light source; which is comparable with lamp based systems. Thermal retinal eye injury is possible when exposed within the Hazard Distance. The Hazard Distance (HD) is defined from the projection lens surface towards the position of the projected beam where the irradiance equals the maximum permissible exposure as described in the chapter "[High Brightness precautions: Hazard Distance](#)", page 16.
- High Brightness Warning: The projector light source may not be switched on or the shutter must be closed when no projection lens is installed.
- Based on international requirements, no person is allowed to enter the projected beam within the zone between the projection lens and the related Hazard Distance (HD). This shall be physically impossible by creating sufficient separation height or by placing optional barriers. Within the restricted area operator training is considered sufficient. The applicable separation heights are discussed in "[High Brightness precautions: Hazard Distance](#)", page 16.
- **Warning:** Laser radiation when optional laser distance meter is installed. Do not stare into laser ranging beam. Class 2 laser beam could result in damage to the eye.
- Don't put your hand in front of the beam.
- This product contains no user serviceable parts. Attempts to modify/replace mechanics or electronics inside the housing or compartments will violate any warranties and may be hazardous. This kind of operations shall only be performed by Barco authorized service personnel.
- Before attempting to remove any of the projector's covers, you must turn off the projector and disconnect from the wall outlet.
- When required to switch off the projector, to access parts inside, always disconnect the power cord from the power net.
- **The power input at the projector side is considered as the disconnect device. When required to switch off the projector, to access parts inside, always disconnect the power cord at the projector side. In case the power input at the projector side is not accessible (e.g. ceiling mount), the socket outlet supplying the projector shall be installed nearby the projector and be easily accessible, or a readily accessible general disconnect device shall be incorporated in the fixed wiring.**

- Do not stack or hang projectors without using the stacking frame.
- Max units in stacked configuration, 3 units.
- Max units in hanging configuration, 2 units.
- When hanging projectors on a truss with the Barco stacking frame, always secure the stack with safety cables between the projectors and the truss.
- When using the projector in a hanging configuration, always mount 2 safety cables. See installation manual for the correct use of these cables.
- Do not place this equipment on an unstable cart, stand, or table. The product may fall, causing serious damage to it and possible injury to the user.
- Only place the projector on a stable surface, or mount it securely using an approved ceiling mount rig.
- It is hazardous to operate without lens or shield. Always switch the output light off when replacing a lens.
- Lenses or shields shall be changed if they have become visibly damaged to such an extent that their effectiveness is impaired. For example by cracks or deep scratches.
- **Cooling liquid circuit.** The projector contains a cooling circuit filled with Mono-ethylene glycol (1,2-ethane diol) and inhibitors in aqueous solution (34% active). If the unlikely event that the cooling circuits have a leak, switch off the device and contact qualified service personnel. The liquid is not for household use. Keep out of reach of children. Harmful by oral intake. Avoid exposure to pregnant women. Avoid contact with eyes, skin and clothing. Avoid inhale of the noxious fumes.
- Never point or allow light to be directed on people or reflective objects within the HD zone.
- All operators shall have received adequate training and be aware of the potential hazards.
- In case of using an external cooling system position the hoses of the cooling system so that they will not be tripped over, pulled, or contact hot surfaces.

### To prevent fire hazard

- Do not place flammable or combustible materials near the projector!
- Barco large screen projection products are designed and manufactured to meet the most stringent safety regulations. This projector radiates heat on its external surfaces and from ventilation ducts during normal operation, which is both normal and safe. Exposing flammable or combustible materials into close proximity of this projector could result in the spontaneous ignition of that material, resulting in a fire. For this reason, it is absolutely necessary to leave an “**exclusion zone**” around all external surfaces of the projector whereby no flammable or combustible materials are present. The **exclusion zone** must be not less than 40 cm (16”) for this projector.
- Do not place any object in the projection light path at close distance to the projection lens output. The concentrated light at the projection lens output may result in damage, fire or burn injuries.
- Ensure that the projector is solidly mounted so that the projection light path cannot be changed by accident.
- Do not cover the projector or the lens with any material while the projector is in operation. . Mount the projector in a well ventilated area away from sources of ignition and out of direct sun light. Never expose the projector to rain or moisture. In the event of fire, use sand, CO<sub>2</sub> or dry powder fire extinguishers. Never use water on an electrical fire. Always have service performed on this projector by authorized Barco service personnel. Always insist on genuine Barco replacement parts. Never use non-Barco replacement parts as they may degrade the safety of this projector.
- Slots and openings in this equipment are provided for ventilation. To ensure reliable operation of the projector and to protect it from overheating, these openings must not be blocked or covered. The openings should never be blocked by placing the projector too close to walls, or other similar surface. This projector should never be placed near or over a radiator or heat register. This projector should not be placed in a built-in installation or enclosure unless proper ventilation is provided.
- Projection rooms must be well ventilated or cooled in order to avoid build up of heat. It is necessary to vent hot exhaust air from projector and cooling system to the outside of the building.
- Let the projector cool completely before storing. Remove cord from the projector when storing.

### To prevent battery explosion

- Danger of explosion if battery is incorrectly installed.
- Replace only with the same or equivalent type recommended by the manufacturer.
- For disposal of used batteries, always consult federal, state, local and provincial hazardous waste disposal rules and regulations to ensure proper disposal.

## To prevent projector damage

- The air filters of the projector must be cleaned or replaced on a regular basis. Cleaning the booth area would be monthly-minimum. Neglecting this could result in disrupting the air flow inside the projector, causing overheating. Overheating may lead to the projector shutting down during operation.
- The projector must always be installed in a manner which ensures free flow of air into its air inlets.
- If more than one projector is installed in a common projection booth, the exhaust air flow requirements are valid for EACH individual projector system. Note that inadequate air extraction or cooling will result in decreased life expectancy of the projector as a whole as well as causing premature failure of the lasers.
- In order to ensure that correct airflow is maintained, and that the projector complies with Electromagnetic Compatibility (EMC) and safety requirements, it should always be operated with all of its covers in place.
- Slots and openings in the cabinet are provided for ventilation. To ensure reliable operation of the product and to protect it from overheating, these openings must not be blocked or covered. The openings should never be blocked by placing the product on a bed, sofa, rug, or other similar surface. This product should never be placed near or over a radiator or heat register. The device should not be placed in a built-in installation or enclosure unless proper ventilation is provided.
- Ensure that nothing can be spilled on, or dropped inside the projector. If this does happen, switch off and remove all power from the projector. Do not operate the projector again until it has been checked by qualified service personnel.
- Do not block the projector cooling fans or free air movement around the projector.
- Do not use this equipment near water.
- **Special care for Laser Beams:** Special care should be used when DLP projectors are used in the same room as high power laser equipment. Direct or indirect hitting of a laser beam on to the lens can severely damage the Digital Mirror Devices™ in which case there is a loss of warranty.
- Never place the projector in direct sunlight. Sunlight on the lens can severely damage the Digital Mirror Devices™ in which case there is a loss of warranty.
- Save the original shipping carton and packing material. They will come in handy if you ever have to ship your equipment. For maximum protection, repack your set as it was originally packed at the factory.
- Unplug this product from the wall outlet before cleaning. Do not use liquid cleaners or aerosol cleaners. Use a damp cloth for cleaning. Never use strong solvents, such as thinner or benzine, or abrasive cleaners, since these will damage the cabinet. Stubborn stains may be removed with a cloth lightly dampened with mild detergent solution.
- To ensure the highest optical performance and resolution, the projection lenses are specially treated with an anti-reflective coating, therefore, avoid touching the lens. To remove dust on the lens, use a soft dry cloth. For lens cleaning follow the instructions precisely as stipulated in the projector manual.
- Only use **zoom** lenses of the Barco TLD+ series on the 4K models of the projector. Using other lenses will damage the internal optics. For suitable fixed TLD+ lenses contact Barco or see Barco website.
- Allowed ambient temperature range depends on altitude:
  - between 0 and 1000 meter altitude: ambient temperature range = 0°C (32°F) to 40°C (104°F)
  - between 1000 and 3000 meter altitude: ambient temperature range = 0°C (32°F) to 30°C (86°F)
- Rated humidity = 0% RH to 80% RH Non-condensed.

## On servicing

- Do not attempt to service this product yourself, as opening or removing covers may expose you to dangerous voltage potentials and risk of electric shock.
- Refer all servicing to qualified service personnel.
- Attempts to alter the factory-set internal controls or to change other control settings not specially discussed in this manual can lead to permanent damage to the projector and cancellation of the warranty.
- Replacement parts: When replacement parts are required, be sure the service technician has used original Barco replacement parts or authorized replacement parts which have the same characteristics as the Barco original part. Unauthorized substitutions may result in degraded performance and reliability, fire, electric shock or other hazards. Unauthorized substitutions may void warranty.
- Safety check: Upon completion of any service or repairs to this projector, ask the service technician to perform safety checks to determine that the product is in proper operating condition.

## Malfunction unit

Remove all power from the projector and refer servicing to qualified service technicians under the following conditions:

- When the power cord or plug is damaged or frayed.

- If liquid has been spilled into the equipment.
- If the product has been exposed to rain or water.
- If the product does not operate normally when the operating instructions are followed. Adjust only those controls that are covered by the operating instructions since improper adjustment of the other controls may result in damage and will often require extensive work by a qualified technician to restore the product to normal operation.
- If the product has been dropped or the cabinet has been damaged.
- If the product exhibits a distinct change in performance, indicating a need for service.

### Stacking and transporting



- Stack maximum 2 rental flight cases high. Never higher.
- Surface on which flight case is standing must be level to ensure that the total load is evenly spread out among the four wheels. The surface must also be able to support the load safely.
- Before stacking or transporting flight cases, check the wheels and their fixation screws for wear or defects.
- Before stacking or transporting flight cases, check that the four lock handles on each flight case are in good working order and locked securely.
- When stacked, make sure the wheels of the upper flight case are precisely positioned in the stacking dishes of the flight case below.
- Stacked flight cases may not be moved. Before stacking, the lower flight case must already be in its final resting position before placing the second upon it.
- Never stack loaded flight cases in a truck or other transport medium, unless each flight case is rigidly strapped tight.
- In the event of a wheel breaking, flight cases must be rigidly strapped tight to prevent a stack collapsing.
- Use an appropriate forklift to raise flight cases and take the necessary precautions to avoid personnel injury.



### Safety Data Sheets for Hazardous Chemicals

For safe handling information on chemical products, consult the Safety Data Sheet (SDS). SDSs are available upon request via [safetydatasheets@barco.com](mailto:safetydatasheets@barco.com).

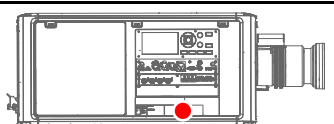
## 1.3 Product safety labels

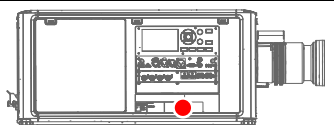
### Light beam related safety labels

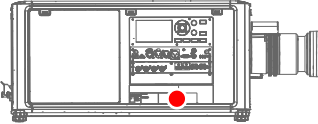
Label image	Label description	Label location
	Hazard RG3: not for household use symbol	
	Hazard RG3: optical radiation warning symbol	

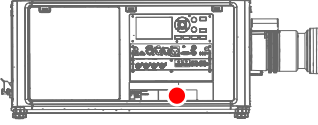
Label image	Label description	Label location
	<p>Hazard class 2: laser radiation warning symbol. 0.95 mW - 638 nm.</p>	
 <p><b>WARNING! DO NOT LOOK INTO THE BEAM NO DIRECT EYE EXPOSURE TO THE PROJECTOR BEAM IS PERMITTED LASER RADIATION - DO NOT STARE INTO LASER RANGING BEAM RG3 IEC EN 62471-5:2015 CLASS 2 IEC EN 60825-1:2014 HAZARD DISTANCE: CONSULT SAFETY MANUAL</b></p> <p>THIS PRODUCT IS IN CONFORMITY WITH PERFORMANCE STANDARDS FOR LASER PRODUCTS UNDER 21 CFR 1040, EXCEPT WITH RESPECT TO THOSE CHARACTERISTICS AUTHORIZED BY VARIANCE NUMBER 2016-V-0144 EFFECTIVE ON DECEMBER 12, 2019.</p> <p>警告! 勿觀看投影機光束 眼睛勿直接接觸可允許暴露的光束 鐳射輻射-勿直視 鐳射範圍內光束 RG3 IEC EN 62471-5: 2015 CLASS 2 IEC EN 60825-1: 2014 危害距離: 請參考安全手冊</p> <p>警告! 勿觀看投影机光束 眼睛勿直接接觸可允許暴露的光束 激光辐射-勿直视 激光范围内光束 RG3 IEC EN 62471-5: 2015 CLASS 2 IEC EN 60825-1: 2014 危害距离: 请参考安全手册</p> <p>ATTENTION! NE PAS REGARDER LE FAISCEAU DU PROJECTEUR EVITER TOUTE EXPOSITION DIRECTE DES YEUX AU FAISCEAU DU PROJECTEUR RAYONNEMENT LASER - NE PAS REGARDER DANS LE FAISCEAU DU TELEMETRE RG3 IEC EN 62471-5:2015 CLASS 2 IEC EN 60825-1:2014 DISTANCE DE SECURITE: CONSULTER LE MANUEL DE SECURITE</p>		

## 1.4 High Brightness precautions: Hazard Distance



### HD

Hazard Distance (HD) is the distance measured from the projection lens at which the intensity or the energy per surface unit becomes lower than the applicable exposure limit on the cornea or on the skin. The light beam is considered (to be) unsafe for exposure if the distance from a person to the light source is less than the HD.

### Restriction Zone (RZ) based on the HD

The HD depends on the amount of lumens produced by the projector and the type of lens installed. See chapter “HD in function of modifying optics”, page 19.

To protect untrained end users (as cinema visitors, spectators) the installation shall comply with the following installation requirements: Operators shall control access to the beam within the hazard distance or install the product at a height that will prevent spectators' eyes from being in the hazard distance. Radiation levels in excess of the limits will not be permitted at any point less than 2.0 meter (SH) above any surface upon which persons other than operators, performers, or employees are permitted to stand or less than 1.0 meter (SW) lateral separation from any place where such persons are permitted to be. In environments where unrestrained behavior is reasonably foreseeable, the minimum separation height should be greater than or equal to 3.0 meter to prevent potential exposure, for example by an individual sitting on another individual's shoulders, within the HD.

These values are minimum values and are based on the guidance provided in IEC 62471-5:2015 section 6.6.3.5.

The installer and user must understand the risk and apply protective measures based upon the hazard distance as indicated on the label and in the user information. Installation method, separation height, barriers, detection system or other applicable control measure shall prevent hazardous eye access to the radiation within the hazard distance.



For example, projectors that have a HD greater than 1 m and emit light into an uncontrolled area where persons may be present should be positioned in accordance with “the fixed projector installation” parameters, resulting in a HD that does not extend into the audience area unless the beam is at least 2.0 meter above the floor level. In environments where unrestrained behavior is reasonably foreseeable, the minimum separation height should be greater than or equal to 3.0 meter to prevent potential exposure, for example by an individual sitting on another individual's shoulders, within the HD. Sufficiently large separation height may be achieved by mounting the image projector on the ceiling or through the use of physical barriers.

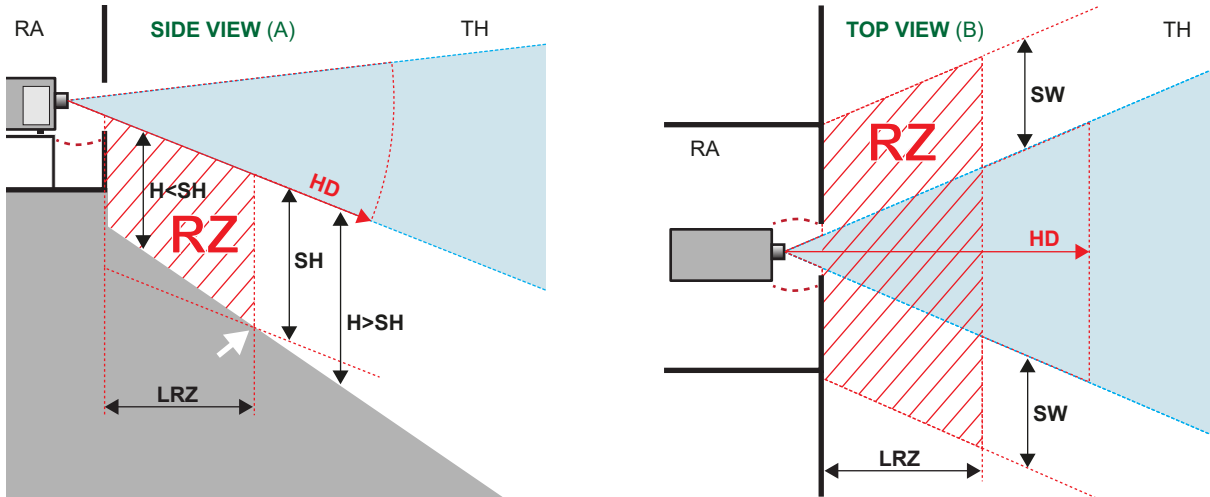

Image 1–2

- A** Side view
- B** Top view
- RA** Restricted Access location (boot area of projector).
- TH** Theater
- RZ** Restriction Zone in the theater

- HD** Hazard Distance
- LRZ** Length Restriction Zone in the theater
- H** Height between surface floor and the light beam
- SH** Separation Height
- SW** Separation Width

Based on national requirements, no person is allowed to enter the projected beam within the zone between the projection lens and the related hazard distance (HD). This shall be physically impossible by creating sufficient separation height or by placing barriers. The minimum separation height takes into account the surface upon which persons other than operator, performers or employees are permitted to stand.

On [Image 1–3](#) a typical setup is displayed. It must be verified if these minimum requirements are met. If required a restricted zone (RZ) in the theater must be established. This can be done by using physical barrier, like a red rope as illustrated in [Image 1–3](#).

The restricted area sticker can be replaced by a sticker with only the symbol.

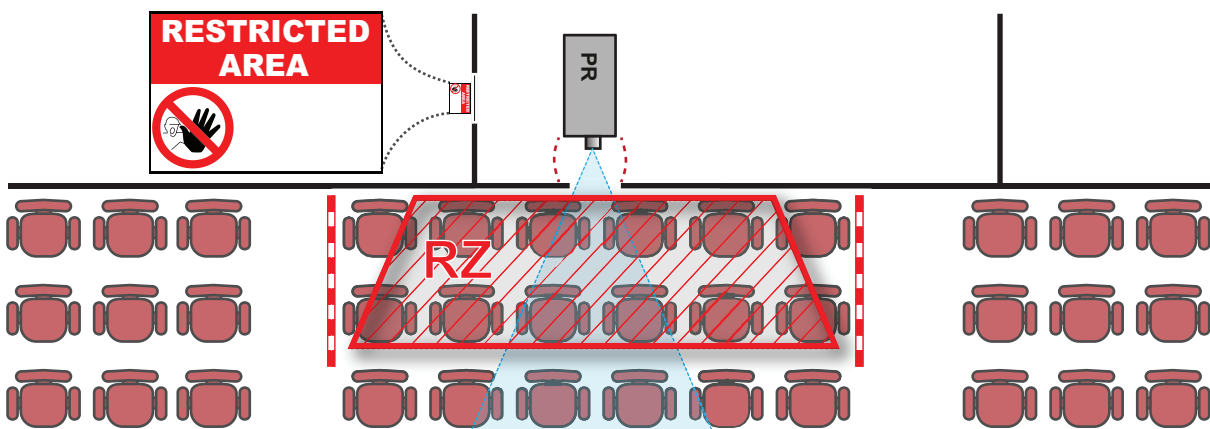

Image 1–3

## USA market

For LIPs (Laser Illuminated Projectors) installed in the USA market other restriction zone conditions apply.

LIPs for installation in restrained environment (cinema theaters, business rooms, class rooms, museums ...) shall be installed at height vertically above the floor such that the bottom plane of the hazard distance zone shall be no lower than 2.5 meters above the floor. Horizontal clearance to the hazard distance zone shall be

not less than 1 meter. Alternatively, in case the height of the separation barrier for the horizontal clearance is at least 1 meter high then the horizontal clearance (SW) can be reduced to:

- 0 meter if the height of the hazard zone is minimum 2.5 meter.
- 0.1 meter if the height of the hazard zone is minimum 2.4 meter.
- 0.6 meter if the height of the hazard zone is minimum 2.2 meter.

LIPs for installations in unrestrained environment (concerts, ...) shall be installed at a height vertically above the floor such that the bottom plane of the Hazard distance Zone shall be no lower than 3 meters above the floor. Horizontal clearance to the hazard distance zone shall be not less than 2.5 meters. Any human access horizontally to the Hazard Zone, if applicable, shall be restricted by barriers. If human access is possible in an unsupervised environment, the horizontal or vertical clearances shall be increased to prevent exposure to the hazard distance zone.

The LIP shall be installed by Barco or by a trained and Barco-authorized installer or shall only be transferred to laser light show variance holders. This is applicable for dealers and distributors since they may need to install the LIP (demo install) and/or they transfer (sell, rent, lease) the LIP. Dealers and distributors shall preserve sales and installation records for a period of 5 years. Variance holders may currently hold a variance for production of Class IIIB and IV laser light shows and/or for incorporating RG3 LIPs. Laser light show variance for RG3 LIPs can be requested by mailing the application to RadHealthCustomerService@fda.hhs.gov.

The installation checklist for laser illuminated RG3 projectors must be fully completed after the installation. The installation checklist can be downloaded from the Barco website. The installer shall preserve the checklist for a period of 5 years.

Install one or more readily accessible controls to immediately terminate LIP projection light. The power input at the projector side is considered as a reliable disconnect device. When required to switch off the projector, disconnect the power cord at the projector side. In case the power input at the projector side is not accessible (e.g. truss mount), the socket outlet supplying the projector shall be installed nearby the projector and be easily accessible, or a readily accessible general disconnect device shall be incorporated in the fixed wiring.

## 1.5 HD for fully enclosed projection systems

**HD**  
 Hazard Distance (HD) is the distance measured from the projection lens at which the intensity or the energy per surface unit becomes lower than the applicable exposure limit on the cornea or on the skin. The light beam is considered (to be) unsafe for exposure if the distance from a person to the light source is less than the HD.

### Restriction Zone (RZ) based on the HD

The projector is also suitable for rear projection applications; projecting a beam onto a diffuse coated projection screen. As displayed in [Image 1–4](#) two areas should be considered: the restricted enclosed projection area (RA) and the observation area (TH).

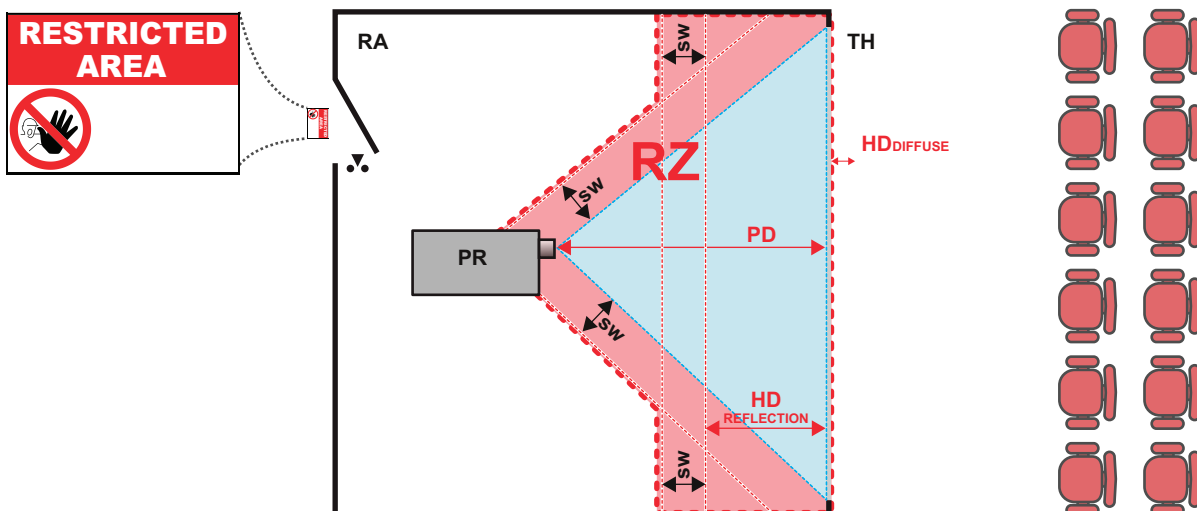

Image 1–4

**RA** Restricted Access location (enclosed projection area).  
**PR** Projector.  
**TH** Theater (observation area).

**RZ** Restriction Zone.  
**PD** Projection Distance.  
**SW** Separation Width. Must be minimum 1 meter.

For this type of setup 3 different HD shall be considered:

- HD as discussed in “High Brightness precautions: Hazard Distance”, page 16, relevant for intrabeam exposure.
- $HD_{\text{reflection}}$  : the distance that has to be kept restrictive related to the reflected light from the rear projection screen.
- $HD_{\text{diffuse}}$  : the relevant distance to be considered while observing the diffuse surface of the rear projection screen.

As described in “High Brightness precautions: Hazard Distance”, page 16, it is mandatory to create a restricted zone within the beam areas closer than any HD. In the enclosed projection area the combination of two restricted zones are relevant: The restricted zone of the projected beam toward the screen; taking into account 1 meter Separation Width (SW) from the beam onward. Combined with the restricted zone related to the rear reflection from the screen ( $HD_{\text{reflection}}$ ); also taking into account a 1 meter lateral separation.

The  $HD_{\text{reflection}}$  distance equals 25% of the difference between the determined HD distance and the projection distance to the rear projection screen. To determine the HD distance for the used lens and projector model see chapter “HD in function of modifying optics”, page 19.

$$HD_{\text{reflection}} = 25\% (HD - PD)$$

The light emitted from the screen within the observation shall never exceed the RG2 exposure limit, determined at 10 cm. The  $HD_{\text{diffuse}}$  can be neglected if the measured light at the screen surface is below 5000 cd/m<sup>2</sup> or 15000 LUX.

## 1.6 HD in function of modifying optics

### Hazard distance

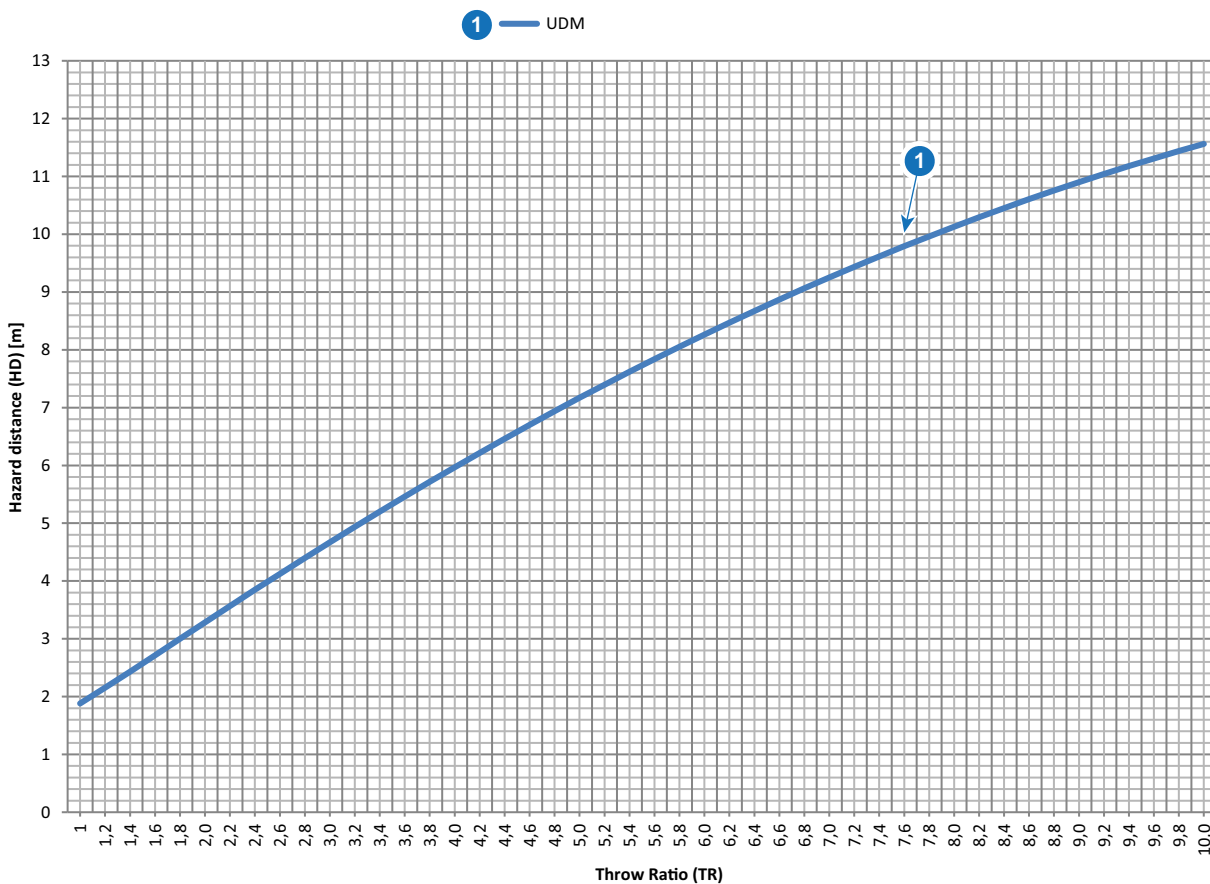
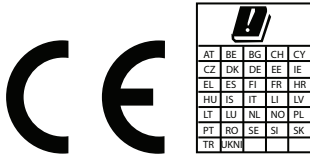

Image 1–5

**HD** Hazard Distance  
**TR** Throw Ratio

## 1.7 Radio equipment (optional)

### CE Conformity



This device may be equipped with WiFi & GSM modules for Pulse Input & Communication unit, which are fit for use in the European Union countries, EFTA and Turkey.

This device is restricted to indoor use only when operating in the 5150 to 5250 MHz frequency range.

Hereby, Barco declares that the radio equipment type UDM is in compliance with Directive 2014/53/EU. The full text of the EU declaration of conformity is available at the following internet address: <https://www.barco.com/support>

#### WiFi & GSM module

##### For WLAN:

- Frequency: 2402 MHz - 2482 Mhz
- Max EIRP: 19 dBm
- Frequency: 5150 – 5350 MHz / 5470 – 5725 Mhz
- Max EIRP: 23 dBm

##### For UMTS:

- Band 1:
  - Frequency: 2100 MHz
  - Max EIRP: 24 dBm
- Band 8:
  - Frequency: 900 MHz
  - Max EIRP: 24 dBm

##### For GSM:

- E-GSM:
  - Frequency: 900 MHz
  - Max EIRP: 33.5 dBm
- EDGE:
  - Frequency: 900 MHz
  - Max EIRP: 28 dBm
- DCS:
  - Frequency: 1800 MHz
  - Max EIRP: 30.5 dBm
- EDGE:
  - Frequency: 1800 MHz
  - Max EIRP: 27 dBm

## 1.8 Compliance

### UK Compliance



This product is fit for use in the UK.

**Authorised Representative:** Barco UK Ltd

**Address:** Building 329, Doncastle Road  
 Bracknell RG12 8PE, Berkshire, United Kingdom

## 1.9 Download Product Manual

### Download Product Manual

Product manuals and documentation are available online at [www.barco.com/td](http://www.barco.com/td).

Registration may be required; follow the instructions given on the website.

**IMPORTANT!** Read Installation Instructions before connecting equipment to the mains power supply.

# Getting Started

# 2

2.1	Getting to know the projector .....	22
2.2	Power on the projector .....	24
2.3	Start image projection .....	25
2.4	Switching to ready mode .....	28
2.5	Power off projector.....	28

## About this chapter

This chapter and by extension this whole document, the user manual, is intended for the user who want's to operate the projector. It does not contain installation instructions because the installation has to be done by trained and qualified service technicians. Refer to the projector installation manual for detailed installation instructions.

## 2.1 Getting to know the projector

### Orientation convention

This manual refers to the left side of the projector as the side at your left hand when standing behind the projector and looking at the projection screen in front of the projector.

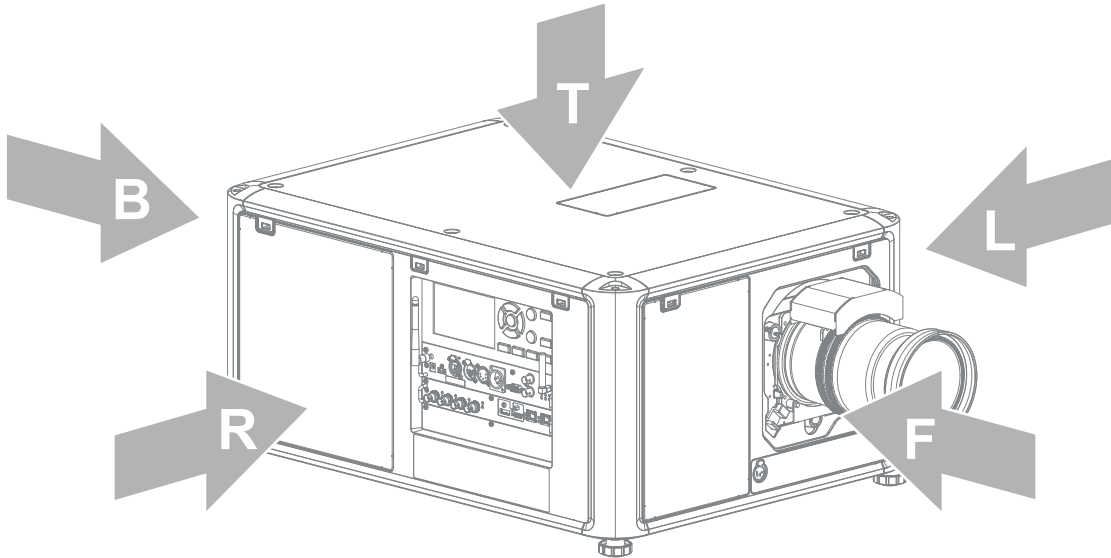

Image 2-1

- |                |                |
|----------------|----------------|
| <b>T</b> Top   | <b>R</b> Right |
| <b>L</b> Left  | <b>B</b> Back  |
| <b>F</b> Front |                |

### Projector component location

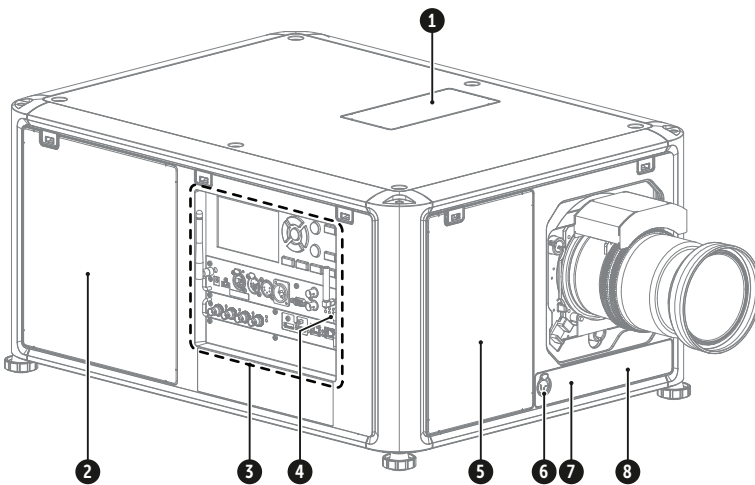

Image 2-2

- |   |   |
|---|---|
| <b>1</b> Dust filter top air inlet        | <b>5</b> Dust filter front air inlet                          |
| <b>2</b> Dust filter side air inlet       | <b>6</b> Auxiliary connector (for external shutter, DMX, ...) |
| <b>3</b> Input & Communication module     | <b>7</b> IR receiver projector front side                     |
| <b>4</b> IR receiver projector right side | <b>8</b> Distance meter (optional)                            |

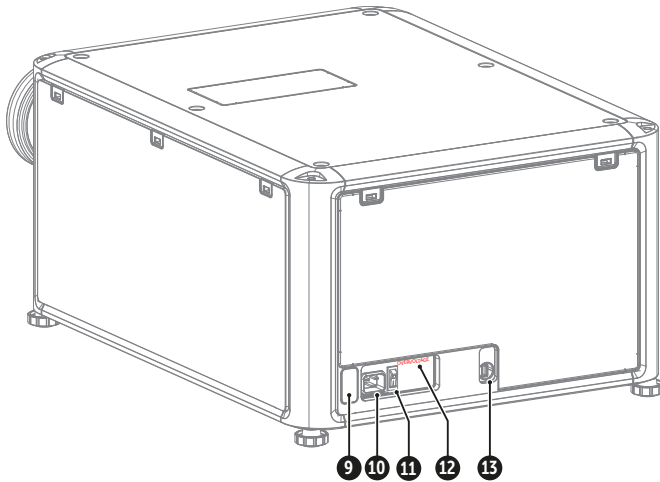

Image 2-3

- |   |  |
|---|--|
| <p><b>9</b> IR receiver projector rear side</p> <p><b>10</b> Mains power input socket (for C19 plug)</p> <p><b>11</b> Power ON/OFF switch</p> | <p><b>12</b> Overvoltage status light</p> <p><b>13</b> USB port (to control motorized rigging frame)</p> |
|---|--|

For detailed info about the Input & Communication module see chapter [“Input & Communication”](#), page 37.

## Environment conditions

Table below summarizes the physical environment in which the projector safely operates or can be stored.

Environment	Operating	Non-Operating
Ambient Temperature (depends on altitude)	0-1000 meter: 0°C (32°F) to 40°C (104°F) 1000-3000 meter: 0°C (32°F) to 30°C (86°F)	-15°C (5°F) to 60°C (140°F)
Humidity	0% RH to 80% RH Non-condensed	0% RH to 90% RH Non-Condensed
Altitude	-60 m (-197 Ft) to 3000 m (9843 Ft) <sup>1</sup>	-60 m (-197 Ft) to 10000 m (32810 Ft)

## Projector airflow

The projector has three air inlets: one at the top, one at the front and one at the right side of the projector. Each air inlet is equipped with a dust filter. For cleaning/replacement instructions see chapter [“Product maintenance”](#), page 169.

There is only one air outlet which is located at the rear of the projector.

1. For PRC (People’s Republic of China) the certified altitude is specified on the product label.

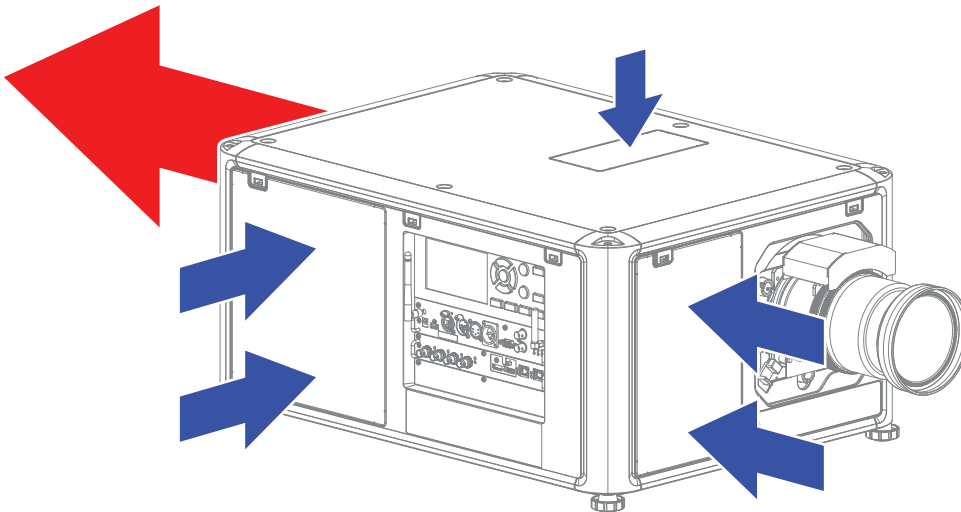

Image 2-4



**CAUTION:** Keep the air inlets and outlet at all times free. Make sure there is a minimum distance of 40 cm (15.7 in) between the air outlet and the nearest solid object.

### Projector Infra Red receivers and Remote Control Unit

The projector has three Infra Red receivers: one at the rear (next to the power input), one at the front (below the lens holder) and one at the right side (integrated in the Input & Communication module).

Point the Remote Control Unit (RCU) directly to the Infra Red (IR) receiver. Make sure you are within the effective operating distance (30 m, 100 ft in a straight line)

The RCU will not function properly if strong light strikes the IR sensor window or if there are obstacles between the RCU and the IR sensor.

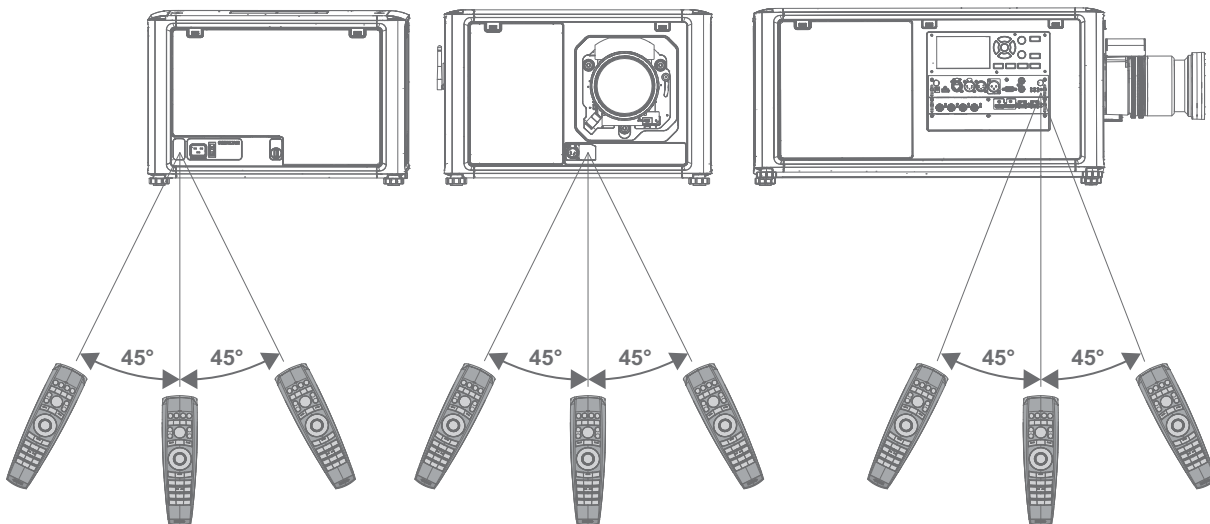

Image 2-5

For detailed info about the RCU see chapter “Pulse Remote Control Unit”, page 29.

## 2.2 Power on the projector

### How to power on

1. Does the **OVERVOLTAGE** status light (reference 1) lit up?
  - ▶ If yes, pull out the power cord immediately. Contact a qualified technician to check the power net.



**!** **Warning:** Never switch on the projector if the **OVERVOLTAGE** status light lit up. Neglecting will cause irreversible damage to the projector.

► **If no**, proceed with the next step.

2. Press the mains switch (reference 2) to switch on this projector.

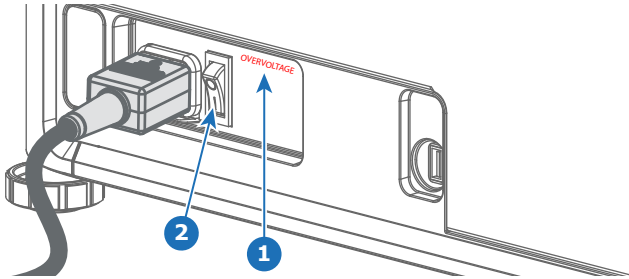

Image 2-6

- When '0' is pressed, the projector is switched off.
- When 'I' is pressed, the projector is switched on.

The projector starts up to ready mode. The **Power on/off** button will blink until ready mode is achieved. Once in ready mode, the Power on/off button will be lit WHITE.

The start up screen is displayed on the touch panel.



Image 2-7

3. Press the **Power on/off** button on the projector, or the **Power On** button on the remote control.

The projector will continue to power on mode. The **Power on/off** button will blink until the projector is ready. Once the projector is ready, the Power button will be lit BLUE.



Image 2-8



The background image of the startup screen and info screens can be changed with Projector Toolset with an installed UDM plug-in.

## 2.3 Start image projection

### Connect the source

1. Connect the source cable with the appropriate input port on the Input & Communication module.

 **Tip:** See chapter “[Input & Communication](#)”, page 37, for more info about supported input formats.

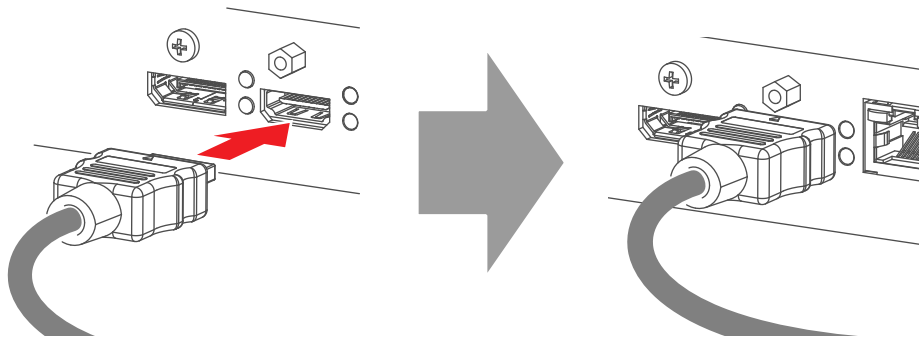

Image 2-9 Example of connecting an HDMI source.

2. Check if the **SYNC** LED lit up **ORANGE** (reference 1). This indicates that the sync is detected on the input signal.

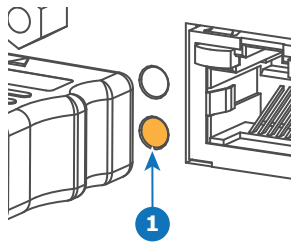

Image 2-10

## Select the source

1. Press the **Input** button (reference I ) on the remote control or local keypad.

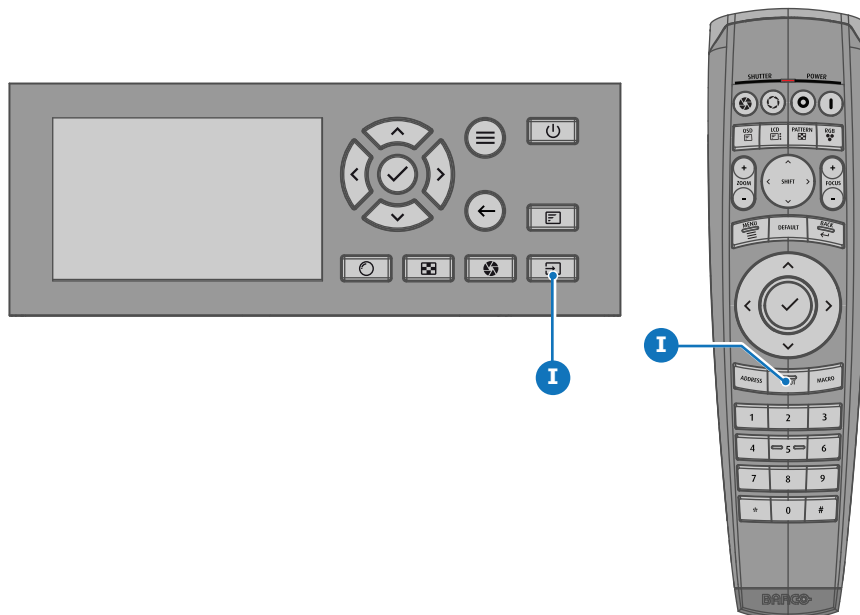

Image 2-11

The *Source selection* menu opens on the LCD display.

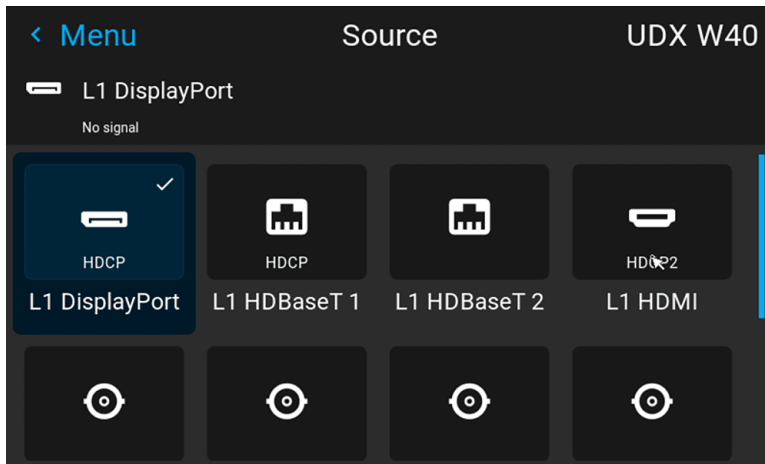

Image 2–12 Example of the input selection menu

2. Use the arrow keys to select the desired source.
  - the **SEL** LED (reference 2) of the selected source lit up GREEN, and
  - the image of the selected source is projected.

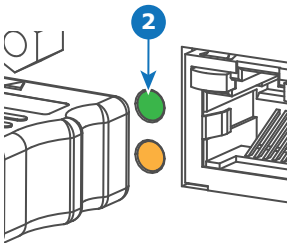

Image 2–13

### Quick test pattern selection

1. Press the Test pattern button (references P) on the remote control or local keypad.

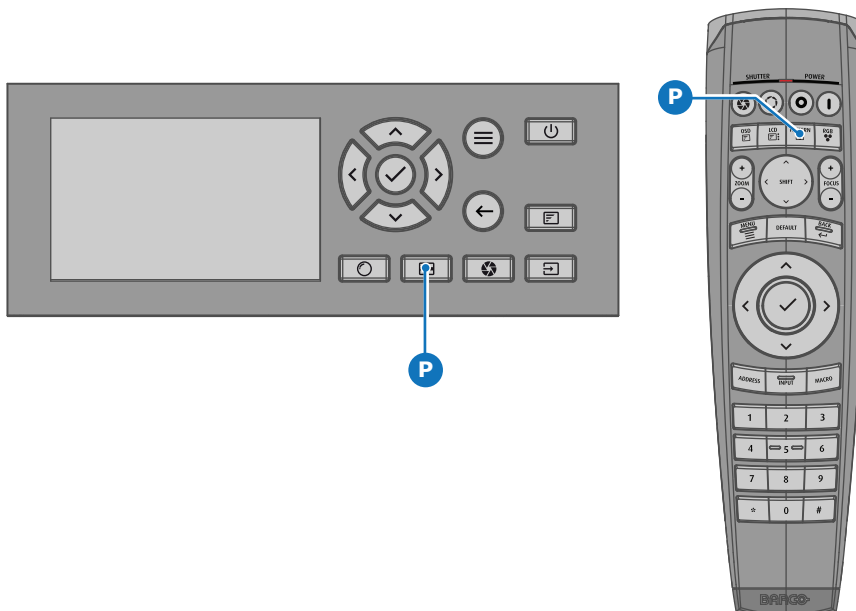

Image 2–14

The *Test pattern* menu opens on the LCD display.

2. Use the arrow keys to select the desired test pattern.

## 2.4 Switching to ready mode

### How to switch to ready mode

1. Press and hold the **Power on/off** button for 3 seconds on the local keypad, or press the **Power Off** button on the remote control.

The projector goes to Ready mode. The after-cooling cycle will start (about 30 seconds). During this period the Power on/off button will blink. Once the after-cooling cycle has ended, the projector will be in ready mode and the Power on/off button will be lit WHITE.

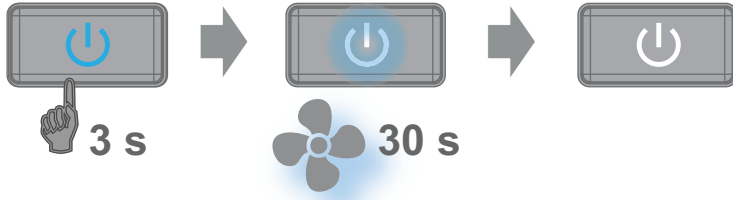

Image 2–15



While in ready mode, you can still navigate through the menus and set a limited amount of parameters.

Depending on the power savings settings of your device, if left untouched the projector will eventually go into standby or eco mode.

## 2.5 Power off projector



**CAUTION:** This procedure assumes the projector is in **standby** or **ready** mode.

### How to power off

1. Switch off the projector with the mains switch. '0' must be pressed.

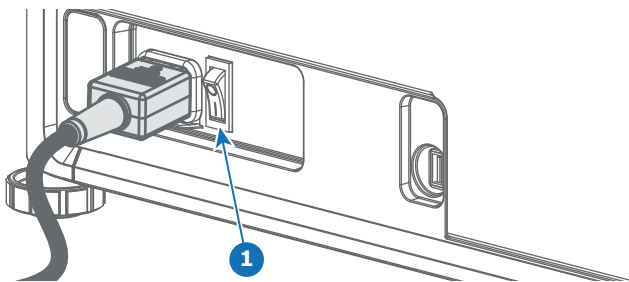

Image 2–16 Mains switch

2. Unplug the power cord from the projector.

# Pulse Remote Control Unit

# 3

3.1	Pulse RCU, battery installation .....	30
3.2	Pulse RCU, protocol setup .....	31
3.3	Pulse RCU, function of the on/off button .....	31
3.4	Using the RCU .....	32
3.5	Pulse RCU, Functionality overview .....	33
3.6	Pulse RCU, function of the “button pressed indicator” .....	33
3.7	Pulse RCU, function of the “RGB filter” button .....	34
3.8	Displaying and Programming addresses into the RCU .....	34
3.9	Using the XLR connector of the RCU .....	34
3.10	Using the mini-jack connector of the RCU .....	35
3.11	Pulse RCU, silicone protection sleeve (optional) .....	35

## 3.1 Pulse RCU, battery installation

### Where to find the batteries for the remote control ?

The batteries are not placed in the remote control unit to avoid control operation in its package, resulting in a shorter battery life time. At delivery the batteries can be found in a separated bag attached to the remote control unit. Before using your remote control, install the batteries first.

### How to install

1. Push the battery cover tab with the fingernail a little backwards (1) and pull, at the same time, the cover upwards (2).

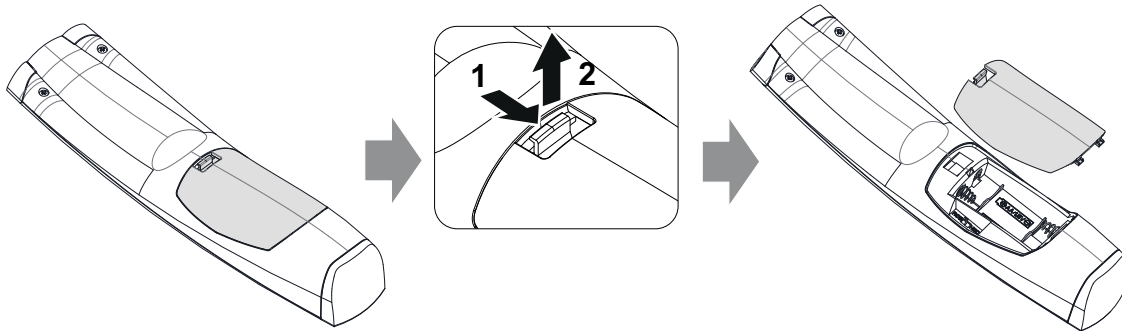

Image 3-1

2. Insert the two AA size batteries, making sure the polarities match the + and - marks inside the battery compartment.



*Tip:* Use alkaline batteries for optimum range and life time.

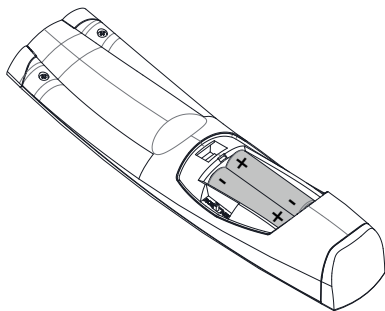

Image 3-2

3. Insert (1) both lower tabs of the battery cover in the gaps at the bottom of the remote control, and press (2) the cover until it clicks in place.

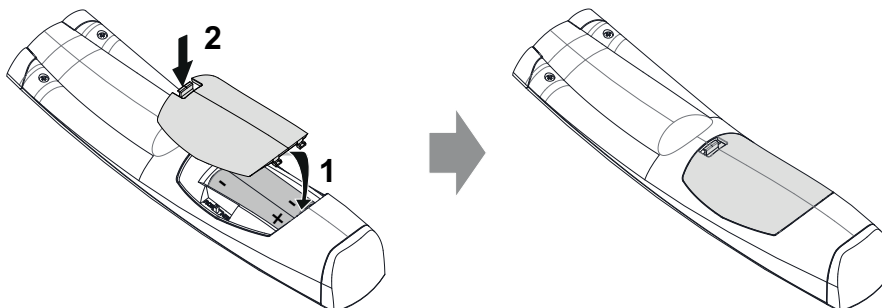

Image 3-3



When replacing batteries, the broadcast address of the RCU will be reset to its default value '0'.



**CAUTION:** Replace with the correct battery type. Use two AA size batteries. There is a risk of explosion if the battery is replaced with an incorrect type.



**CAUTION:** Replace the battery as explained above. There is a risk of explosion if the battery is incorrectly installed.

## 3.2 Pulse RCU, protocol setup

### About the used protocol

The protocol is the code send out by the remote control when a button is pressed. Depending on this code, the projector can decode the signals. The remote control can be used with two different protocols: RC5 and NEC. Depending on the projector to control the remote control can be switched between these protocols.

### Which protocol to use

- The **NEC** protocol has to be used for Barco projectors based on the Pulse platform: F70, F80, F90, HDX 4K, UDX, UDM, XDL, etc.
- The **RC5** protocol has to be used all legacy Barco projectors: HDQ 2k40, HDF, HDX W, etc.

### How to set

1. Remove the cover. For more info on how to remove, see [“Pulse RCU, battery installation”](#), page 30.
2. Place the switch in the desired position.

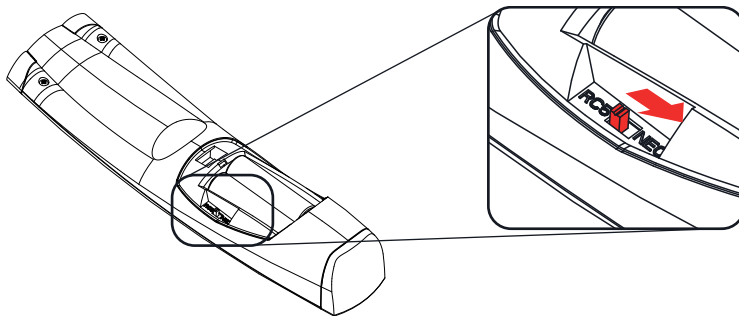

Image 3–4

### Remarks when using the RC5 protocol

Due to new or updated functionality not all buttons of the Pulse RCU are one-to-one compatible with the legacy Barco RCU and projectors. Take the following limitations into account:

- Buttons **Shutter open** and **Shutter close** emit the same code when in RC5 mode. This because the legacy RCU's only had 1 button for Shutter functionality.
- Buttons **Power on** and **Power off** emit the same code when in RC5 mode. This because the legacy RCU's only had 1 button for Power functionality.
- The **RGB filter** button is not supported.
- The **Input selection** button is not supported.
- The **Default value** button is not supported.
- The **Macro** button is not supported.

## 3.3 Pulse RCU, function of the on/off button

### Function of the remote control on/off button

The Pulse remote control unit has at the front side an on/off switch (reference 1 [Image 3–5](#)). Switching off the remote control prevents that unwanted commands are send due to an accidental key press. Furthermore, switching the RCU off will extend the battery life time of the remote control.

To activate the remote control, press the on/off button.

To deactivate the remote control, press the on/off button again.

Default after (re)placing batteries, is “ON”.

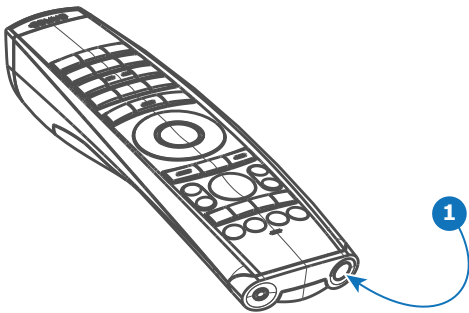

Image 3-5

## 3.4 Using the RCU

### Pointing to the reflective screen or IR sensors

Switch on the RCU and point the front of the RCU to the reflective screen surface or point directly to one of the projector IR sensors. Make sure you are within the effective operating distance (30 m, 100 ft in a straight line). The RCU will not function properly if strong light strikes the IR sensor window or if there are obstacles between the RCU and the IR receiver.

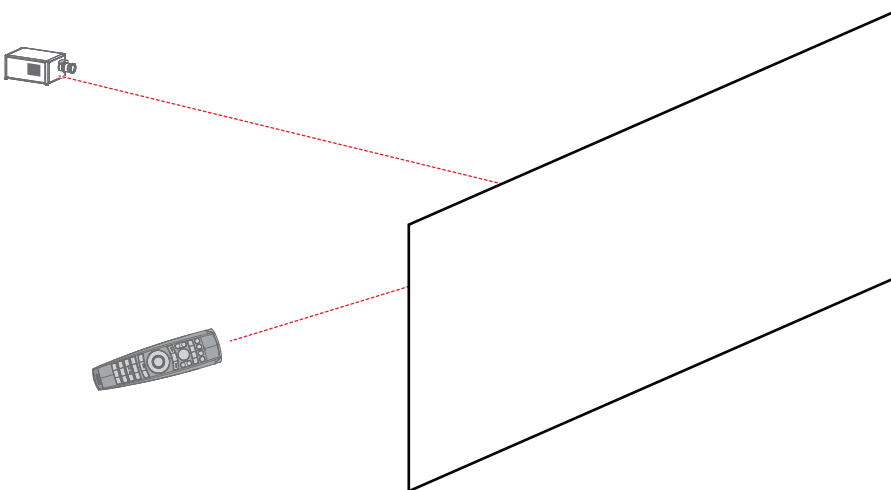

Image 3-6

The RCU can also hard-wired been used. See chapter [“Using the XLR connector of the RCU”](#), page 34.

### Using the RCU in combination with a 3D emitter

When using a 3D emitter that radiates IR beams (e.g. the optional 3D emitter that Barco provides), the IR beams of the 3D emitter may interfere with the IR communication between projector and the RCU.

If such interference occurs, connect the RCU to the projector using the remote cable with XLR connector. It is also be advised to turn the IR receivers of the projector off to avoid the 3D emitter interference. The IR receivers can be turned off in the GUI: *System Settings > Communication > IR Control* .



## 3.5 Pulse RCU, Functionality overview

### Remote Control Unit buttons

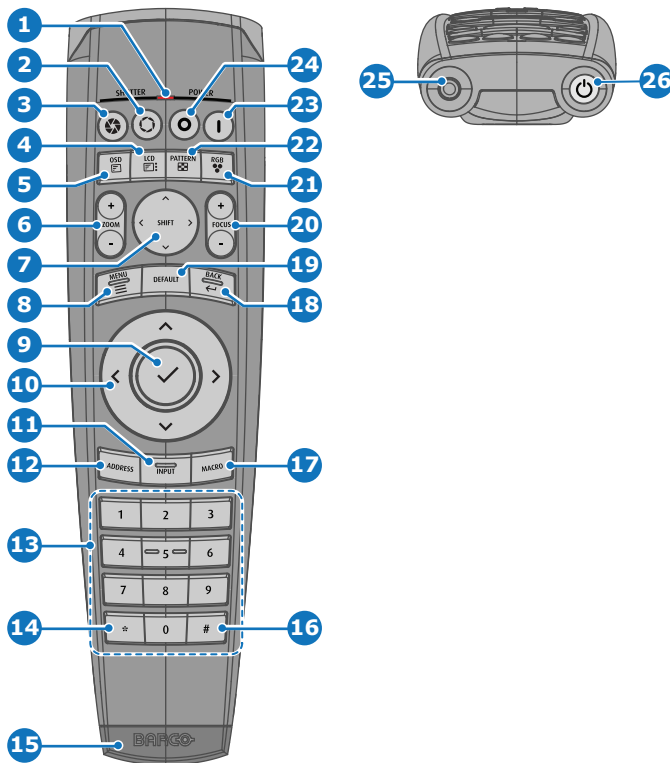

Image 3-7

- |                                    |  |
|------------------------------------|--|
| <b>1</b> Button pressed indicator  | <b>14</b> Backspace (while entering values)    |
| <b>2</b> Shutter open              | <b>15</b> XLR connector                        |
| <b>3</b> Shutter close             | <b>16</b> Decimal mark (while entering values) |
| <b>4</b> LCD panel on / off        | <b>17</b> Macro button                         |
| <b>5</b> Project OSD on / off      | <b>18</b> Menu back                            |
| <b>6</b> Lens zoom                 | <b>19</b> Default value button                 |
| <b>7</b> Lens shift                | <b>20</b> Lens focus                           |
| <b>8</b> Menu open / close         | <b>21</b> RGB filter                           |
| <b>9</b> Menu selection, OK button | <b>22</b> Test patterns                        |
| <b>10</b> Menu navigation          | <b>23</b> Power on                             |
| <b>11</b> Input selection          | <b>24</b> Power off                            |
| <b>12</b> Address button           | <b>25</b> 3.5 mm jack                          |
| <b>13</b> Numeric buttons          | <b>26</b> RCU on / off                         |

## 3.6 Pulse RCU, function of the “button pressed indicator”

### Functions button pressed indicator

- Rapidly flashes when commands are sent, this is the normal “button pressed” indication.
- 1 Short flash when remote control is switched ON by means of the on/off button.
- Continuously lit (up to 5 seconds) when address digits are expected after pressing the ADDR button.
- Slowly flashes (2 times a second) when the battery level is becoming low; typically when more than 85% of the useful life is past.

## 3.7 Pulse RCU, function of the “RGB filter” button

### Filtering the color of the projected image

By pressing the RGB filter button on the RCU you can place a color filter on the output of the projector. This feature can be useful during the installation and configuration of a multi-projector or multi-channel setup. By having one projector project a red image and another project a green image, it is easier to spot and adjust the overlap section.

By pressing this button multiple times, you will have different active filters, in the following cycle:

- Red + Green + Blue (default)
- Red only
- Green only
- Blue only
- Red + Green
- Green + Blue
- Red + Blue
- Red + Green + Blue
- etc



After powering up, the colors will always revert back to full RGB.

## 3.8 Displaying and Programming addresses into the RCU

### Displaying the Projector Address on the Screen.

1. If the projector is on, press the menu key and navigate to the Status page. The projector address and the broadcast address can be seen under the Communication heading.

The projector's address is displayed on the LCD status screen and / or the OSD.

### How to Program an Address into the RCU?

1. Press the **Address** button until the *Button pressed indicator* lights up continuously (proximately 5 seconds).
2. Enter the address with the digit buttons within the time the indicator lights up (also proximately 5 seconds).



*Note:* That address can be any value between 0 and 31.



*Tip:* A few examples:

To enter address 3, press "3" digit button on the RCU to set the RCU's address to 3 and wait until the *button pressed indicator* is out. Alternatively, you can also press "0" and "3". This way, the *button pressed indicator* goes out immediately.

To enter address 31, then press "3" and "1" on the digit button on the RCU and the *button pressed indicator* goes out immediately.

## 3.9 Using the XLR connector of the RCU



Connecting a cable with the XLR connector will reset the broadcast address of the RCU to its default value '0'.

## How to use the XLR connector

1. Remove the XLR cover by pulling it backwards.

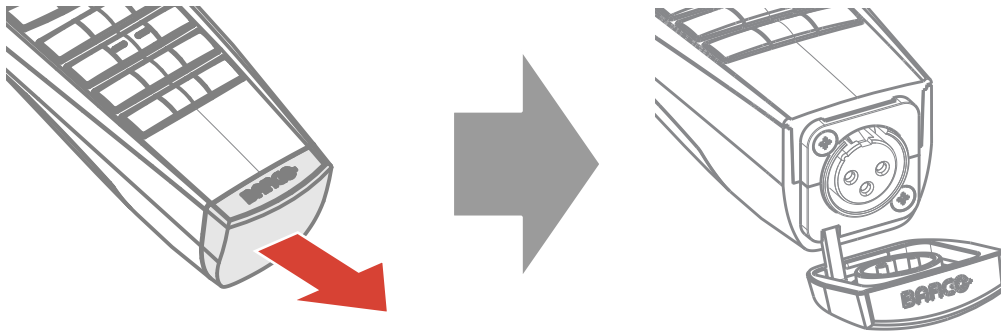



Image 3–8

2. Connect a cable with XLR plug into the XLR connector of the RCU.
3. Connect the other end of the cable with the XLR input of the projector.

 *Note:* While the XLR cable is connected, the IR beam of the RCU is switched off.

## 3.10 Using the mini-jack connector of the RCU



Connecting a cable with the mini-jack connector will reset the broadcast address of the RCU to its default value '0'.

### How to use the mini-jack connector

1. Connect a cable with the mini-jack connector (reference 2 [Image 3–9](#)) of the RCU.
2. Connect the other end of the cable with the mini-jack input of the projector.

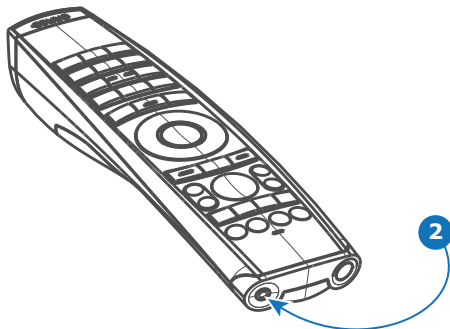



Image 3–9

 *Note:* While the mini-jack cable is connected, the IR beam of the RCU is switched off.

## 3.11 Pulse RCU, silicone protection sleeve (optional)

### Introduction

Barco offers a silicone form fitting protection sleeve for the Pulse RCU. The silicone material keeps it comfortably, non slip and soft touch. All buttons and holes remain accessible. The sleeve is quick and easy installed. For ordering information see Barco website.

## How to install

1. Pull off the rubber XLR-lid from the RCU.



Image 3-10

2. Place back side (XLR side) of the RCU into the sleeve and pull the other side of the sleeve over the front side of the RCU.

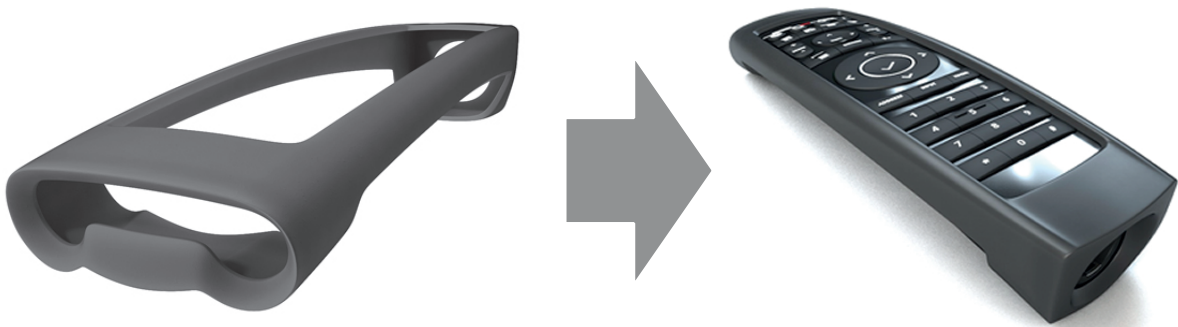

Image 3-11

# Input & Communication

# 4

4.1	Introduction .....	38
4.2	Local Keypad and LCD panel .....	38
4.3	LCD touch panel.....	39
4.4	Communication connections.....	40
4.5	LED and Button indication chart.....	42
4.6	Pulse Quad Combo input Mk II .....	43
4.7	Pulse Quad Combo input Mk I .....	44
4.8	Pulse Quad DP 1.2 input .....	45
4.9	Pulse SFP input.....	46

## 4.1 Introduction

### General

The Input & Communication module consists of a local keypad with LCD panel (1), a communication panel (4) and a Quad Combo input board (5). The free input slot can be used for optional modules (e.g. the Quad DP 1.2 input board).



Two boards of the same type can be used without restrictions. You can mount a second Quad Combo Input board in the free input slot (6). Alternatively, you can also remove the pre-mounted Quad Combo Input board and replace it with a second optional module (for example, a second Quad DP 1.2 input board).

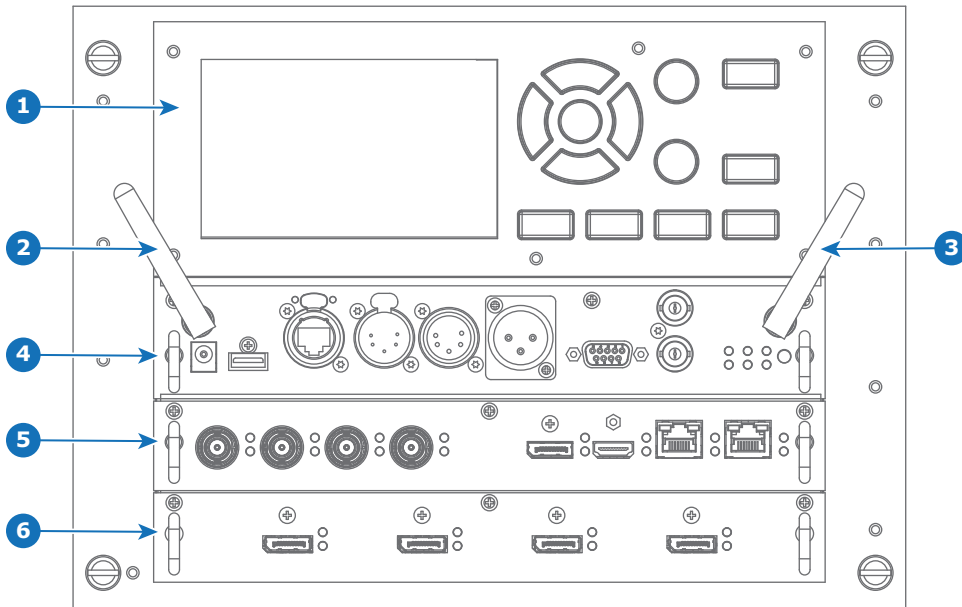

Image 4-1

- |   |                                      |   |  |
|---|--------------------------------------|---|--|
| 1 | Local Keypad and LCD panel           | 4 | Communication Panel  |
| 2 | Optional antenna for WiFi connection | 5 | Quad Combo Input board   |
| 3 | Optional antenna for GSM             | 6 | Free input slot (here filled with the Quad DP 1.2 Input board) |

## 4.2 Local Keypad and LCD panel

### Overview

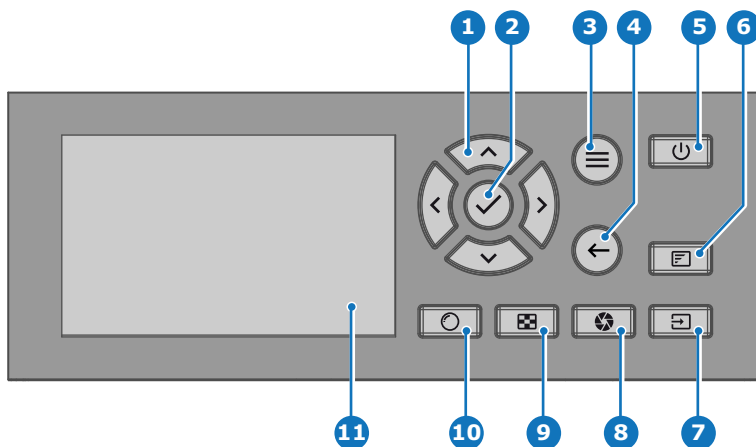

Image 4-2

- |          |                              |           |                      |
|----------|------------------------------|-----------|----------------------|
| <b>1</b> | Menu navigation              | <b>7</b>  | Input selection      |
| <b>2</b> | Menu confirmation, OK button | <b>8</b>  | Shutter open / close |
| <b>3</b> | Menu open / close            | <b>9</b>  | Test patterns        |
| <b>4</b> | Menu back                    | <b>10</b> | Lens adjustment      |
| <b>5</b> | Power on / off               | <b>11</b> | LCD panel            |
| <b>6</b> | Project OSD on / off         |           |                      |

## Local Keypad

The Keypad gives direct access to several functions, in addition to access to the menu system.

The keypad has a backlight that can be switched on and off manually. By default the light turns off after 5 minutes.

The Power button and Shutter buttons are equipped with white, blue and red backlit LEDs. The other keys are only equipped with white and blue backlit LEDs. The LEDs are controlled according to the features available.

## LCD panel

The LCD panel has two main functions:

1. Showing the menus, the adjustment information and also a mirror of the OSD, (On Screen Display) described in *User Interface* when this is enabled.
2. Information regarding the status of the projector showing this data:
  - Projector status
  - Network address
  - Active source
  - Current firmware version
  - Operation Data
  - Active functions (Enabled Functions).

Toggle between the two indications by using the **Menu** button on the keypad, or on the remote control.

The LCD Display will fade out 30 seconds after the last key operation.

## 4.3 LCD touch panel



The LCD menus can occasionally be slightly different in layout compared with the OSD menu, due to a more optimal layout regarding to the touch functionality of the LCD.

### LCD touch panel functionality

In addition to the remote control and the keypad, it is also possible to navigate in the menus with the touch functionality in the LCD panel.

Press the icons to select the functions.

Select switches to toggle.

Select and drag sliders to adjust slider value.

## 4.4 Communication connections

### Communication Panel

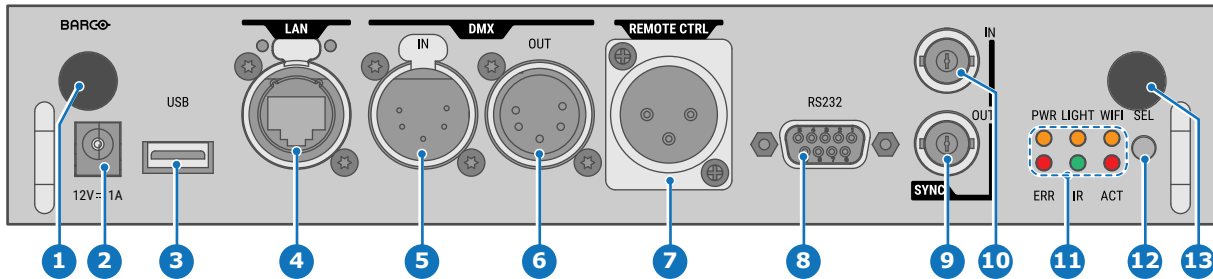

Image 4-3

- |   |  |    |                                |
|---|--|----|--------------------------------|
| 1 | WIFI antenna for wireless IP (optional)                | 8  | RS232 for serial communication |
| 2 | 12V 1A output  | 9  | Sync Out 3D                    |
| 3 | Firmware update / USB download log files               | 10 | Sync In 3D                     |
| 4 | 10/100 base-T for external control over IP and Art-Net | 11 | Status lights                  |
| 5 | DMX interface input                                    | 12 | IR receive sensor              |
| 6 | DMX interface output                                   | 13 | GSM antenna input (optional)   |
| 7 | XLR input for wired projector control                  |    |                                |



**CAUTION:** Ethernet should only be connected to either the 10/100 base-T port (on the communication panel) or the HDBaseT input (on the Quad Combo Input Mk II). Using both at the same time will lead to undefined behavior.

### 12 V output

12 V output, maximum 1 A, available when projector is not in stand by.

### DMX interface

DMX is used as communication bus between different devices in the light technic. Each device has an input and an output, so that the bus can be looped between the different devices. According the standard a five wire cable with XLR connector is used.

You can use the DMX input port to connect a DMX device (DMX console) to the projector. This way you can control the projector from that DMX device (console). The DMX output port can be connected with the next device in the loop.

#### DMX

Pin	Description
1	Earth
2	Cold
3	Hot
4	Return - (or not used)
5	Return + (or not used)



#### DMX

DMX-512 Lighting protocol over RS-485 interface. Carries information of 512 channels from a lighting controller to lighting devices. Standardized by USITT.

### RS232/RS422 input

The communication interface of the UDM series projector supports RS232 and RS422 serial communication on two different types of input connectors, a Sub-D connector and an USB connector acting as RS input when connected to an USB input of a PC.

You can use the RS232/RS422 input to connect a local PC to your UDM series projector. By this way you can configure and control your projector from your local PC.



Advantages of using RS232/RS422 serial communication:

- easy adjustment of the projector via PC (or MAC).
- allow storage of multiple projector configurations and set ups.
- wide range of control possibilities.
- address range from 0 to 255.
- sending data to the projector (update).
- copying data from the projector (backup).

### RS232/422 input (Sub-D) port

Pin	Description
1	DCD : Data Carrier Detect
2	RXD- : Receive Data
3	TXD- : Transmitted Data
4	DTR : Data Terminal Ready [RS232] / TXD+ : Transmitted Data [RS422]
5	GND : Ground
6	DSR : Data Set Ready [RS232] / RXD+ : Received Data [RS422]
7	— (not connected) —
8	CTS : Clear To Send
9	RI : Ring Indicator

#### RS232



An Electronic Industries Association (EIA) serial digital interface standard specifying the characteristics of the communication path between two devices using either D-SUB 9 pins or D-SUB 25 pins connectors. This standard is used for relatively short-range communications and does not specify balanced control lines. RS-232 is a serial control standard with a set number of conductors, data rate, word length and type of connector to be used. The standard specifies component connection standards with regard to computer interface. It is also called RS-232-C, which is the third version of the RS-232 standard, and is functionally identical to the CCITT V.24 standard. Logical '0' is  $> +3V$ , Logical '1' is  $< -3V$ . The range between  $-3V$  and  $+3V$  is the transition zone.

#### RS422



An EIA serial digital interface standard that specifies the electrical characteristics of balanced (differential) voltage, digital interface circuits. This standard is usable over longer distances than RS-232. This signal governs the asynchronous transmission of computer data at speeds of up to 920,000 bits per second. It is also used as the serial port standard for Macintosh computers. When the difference between the 2 lines is  $< -0.2V$  that equals with a logical '0'. When the difference is  $> +0.2V$  that equals to a logical '1'.

## USB port

The communication interface is equipped with a master USB port, type "A" connector. This USB port will simplify the service procedures for firmware updates or for downloading the log files without a network connection.

If the only file on the USB device is the firmware file (a "\*.fw" file), the projector will automatically start one of the following processes.



- **cornet<version nr>.fw**: The projector will upgrade or downgrade, depending on the version number.
- **LogExtractor.fw**: The log files will be downloaded.



Make sure that any used USB-stick is FAT32 compatible and contains no other files or folders.

## 4.5 LED and Button indication chart

### Button Backlight Status

Button	Color status	Description
<b>Power button</b> 	Blinking WHITE (slow)	Projector starts up (booting)
	Blinking WHITE (fast)	Firmware upgrade
	Solid WHITE	Projector is in Standby or Ready mode
	Blinking BLUE	Projector goes to ON mode
	Solid BLUE	Projector is ON
	Blinking RED	Error condition
<b>Shutter button</b> 	Off (no color)	Projector is OFF, starts up, or is in Standby or Ready mode.
	Solid WHITE	Projector is ON, shutter is open
	Solid RED	Projector is ON, shutter is closed

### LED Status

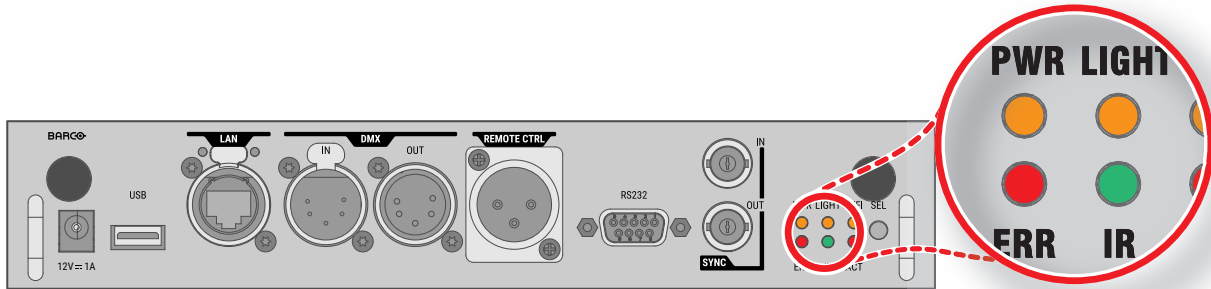

LED	Color status	Description
PWR (power LED)	Off	Projector powers up
	RED	Projector is in Standby mode
	ORANGE	Projector is in Ready mode
	GREEN	Projector is on
LIGHT (Illumination LED)	Off	Light source is off
	RED	No light source detected
	ORANGE	Light source is on in ECO mode
	GREEN	Light source is on in normal mode
ERR (error LED)	GREEN-ORANGE	Light source is on in CLO mode
	Off	No error
	RED toggles on/off	Error
IR	ORANGE toggles on/off	Warning
	RED	IR signal received
	GREEN	IR signal acknowledged

## 4.6 Pulse Quad Combo input Mk II

### Overview Quad Combo Input Mk II

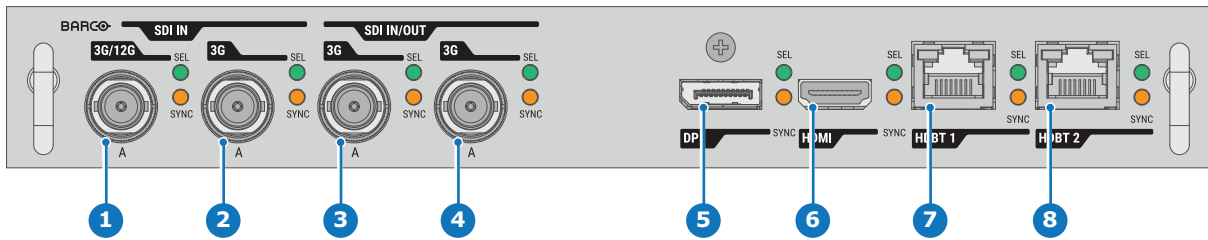

Image 4-4

- |   |   |
|---|---|
| <ul style="list-style-type: none"> <li>1 Quad SDI channel A: 3G/12G input</li> <li>2 Quad SDI channel B: 3G input</li> <li>3 Quad SDI channel C: 3G SDI input + 3G/12G output</li> <li>4 Quad SDI channel D: 3G SDI input / output</li> </ul> | <ul style="list-style-type: none"> <li>5 DisplayPort Input</li> <li>6 HDMI input</li> <li>7 HDBaseT input 1</li> <li>8 HDBaseT input 2</li> </ul> |
|---|---|

### Functionality of the Quad Combo input Mk II

The Quad Combo Input Mk II support 12G input and throughput on the SDI connectors.

Compared with the Mk I the Mk II includes the following:

- **SDI input A** supports **12G** input signals.
- **SDI input C** functions as a **loop-through output** for any signal placed on **input A**.
- **SDI input D** functions as a **loop-through output** for any signal placed on **input B**.
- **HDBaseT input 1** supports **network connectivity**.



**CAUTION:** Ethernet should only be connected to either the 10/100 base-T port (on the communication panel) or the HDBaseT input (on the Quad Combo Input Mk II). Using both at the same time will lead to undefined behavior.

### SDI input & output – How does it work?

When connecting an SDI source to the projector and the signal is HD or 3G, you can choose any of the four input connectors.

When connecting multiple projectors with the same signal, you can connect the signal as follows:

- Connect the source signal to Input A or B of the first projector.
- If the source signal is connected to **input A**, connect **input/output C** to the Input of the following projector.
- If the source signal is connected to **input B**, connect **input/output D** to the Input of the following projector.
- Continue in the same fashion until all projectors are connected.

When connecting a 12G SDI source to the projector, you can only connect that source to input A.



Only Input A accepts 12G SDI signals . While it is technically possible to connect a 12G SDI source to Input B and connect that source to another projector in line (using Input/Output D), this first projector itself will not be able to process the 12G signal.

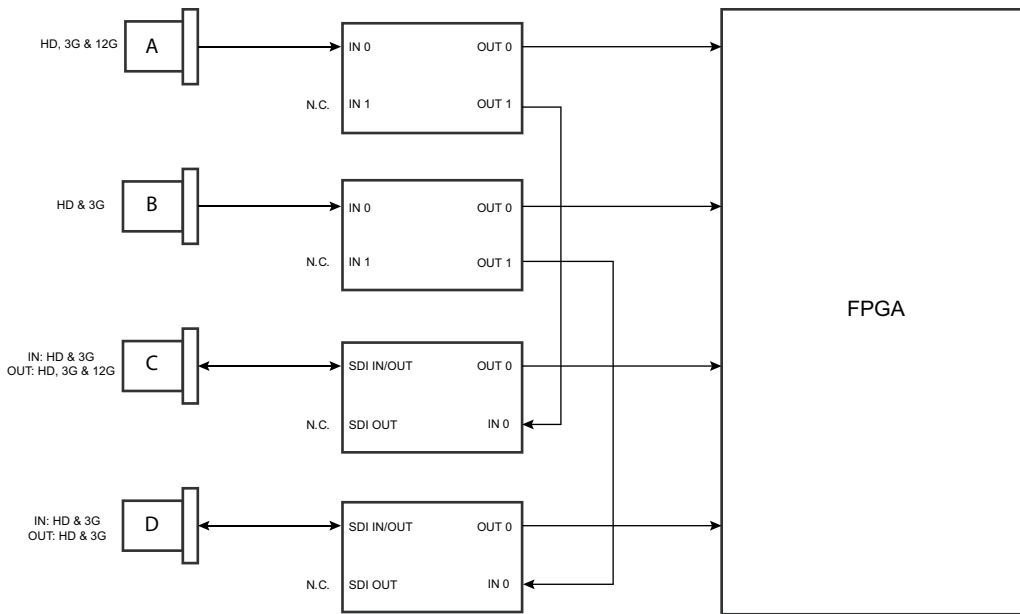

Image 4-5

### LED behavior

- The SYNC LED lit up ORANGE when valid input sync is detected.
- The SEL LED lit up GREEN when the input is selected.
- The SEL LED blinks GREEN when the input/output is selected and configured as output.



For specifications about the supported inputs for SDI, HDMI, HDBaseT and DisplayPort 1.2 see chapter “Specifications”, page 177.

## 4.7 Pulse Quad Combo input Mk I

### Overview Quad Combo input Mk I

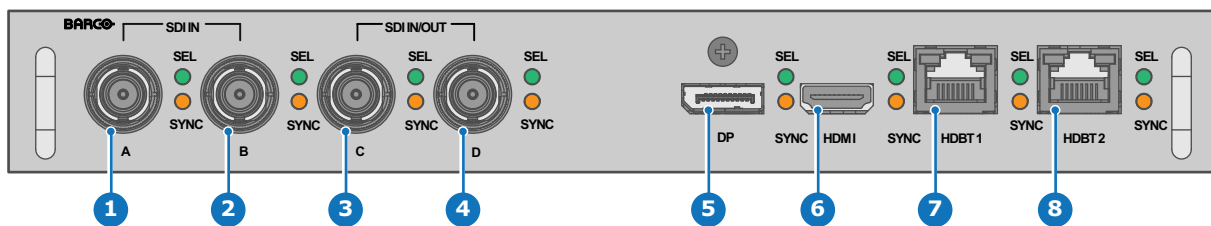

Image 4-6

- |                                       |                            |
|---------------------------------------|----------------------------|
| <b>1</b> Quad SDI channel A: 3G input | <b>5</b> DisplayPort Input |
| <b>2</b> Quad SDI channel B: 3G input | <b>6</b> HDMI input        |
| <b>3</b> Quad SDI channel C: 3G input | <b>7</b> HDBaseT input 1   |
| <b>4</b> Quad SDI channel D: 3G input | <b>8</b> HDBaseT input 2   |

### LED behavior

- The SYNC LED lit up ORANGE when valid input sync is detected.
- The SEL LED lit up GREEN when the input is selected.



For specifications about the supported inputs for SDI, HDMI, HDBaseT and DisplayPort 1.2 see chapter “Specifications”, page 177.

## Remark concerning the Mk I and Mk II inputs boards

The Mk I input board miss functionality that has been implemented on the Mk II input board. These missing features include:

- **Loop-through** functionality
- **12G SDI** support
- Network connectivity on HDBaseT inputs

The projector is now standard equipped with the Mk II input board. For details and specifications see chapter [“Pulse Quad Combo input Mk II”, page 43.](#)

## Visual difference between the Mk I and Mk II input boards

There is one real visual aid to tell the two variants apart. There are visual markings added on the Mk II input board, marking which connector supports 12G and which only supports 3G.

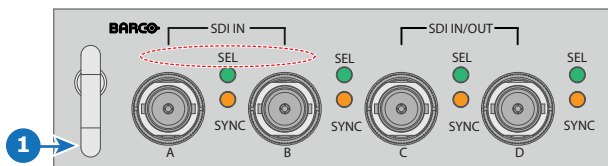

Image 4–7 Quad Combo Input Mk I board, without markings above the SDI inputs

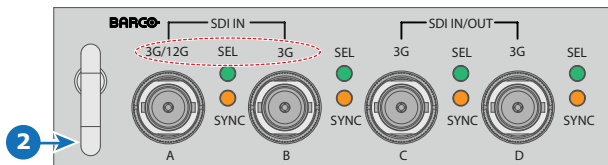

Image 4–8 Quad Combo Input Mk II board, with 3G/12G markings above the SDI inputs/outputs.

## 4.8 Pulse Quad DP 1.2 input

### Quad DP 1.2 input

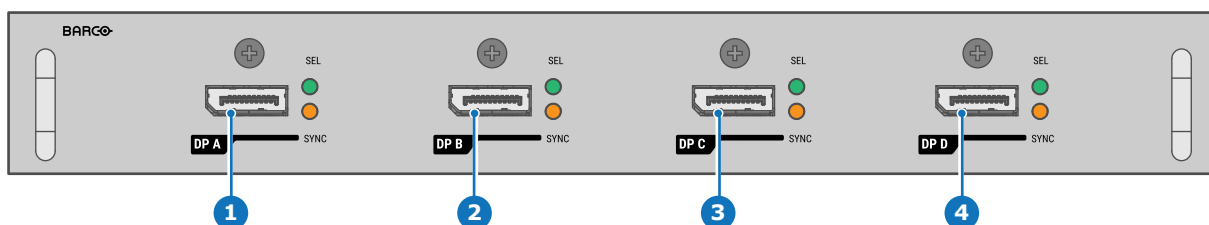

Image 4–9

- 1 Quad DisplayPort channel A input
- 2 Quad DisplayPort channel B input
- 3 Quad DisplayPort channel C input
- 4 Quad DisplayPort channel D input

### LED behavior

- The SYNC LED lit up ORANGE when valid input sync is detected.
- The SEL LED lit up GREEN when the input is selected.



For specifications about the supported inputs for DisplayPort 1.2 see chapter [“Specifications”, page 177.](#)

## 4.9 Pulse SFP input



The Barco SFP Input Board has been designed and tested to work alongside the Barco SFP Output Board.

However, it is possible that the SFP Input board can also work with other third-party devices that support 12G over fiber. Due to the many third-party options available on the market, the input board could not be tested for every option available.

### Overview SFP input

The SFP Input board is used to connect 12G SDI over fiber. The SFP input is delivered without any connector. It is up to the customer to buy the necessary connectors, transceivers and cables. These parts can be mounted on the indicated places on the front panel of the board.

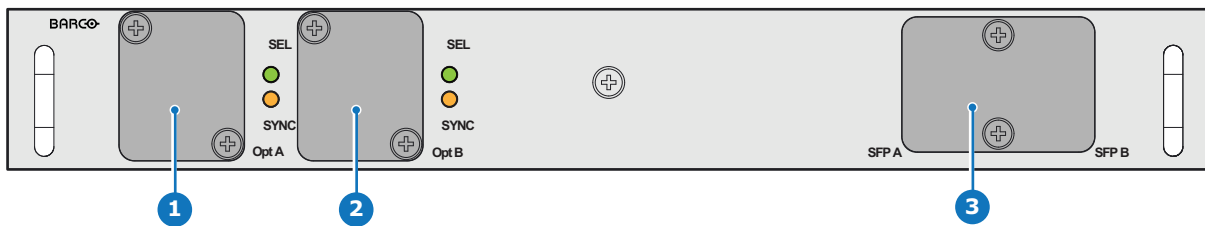

Image 4–10

- 1 Neutrik Duo optical connector or Neutrik Quad optical connector
- 2 Neutrik Duo optical connector or Neutrik Quad optical connector
- 3 2x12G SDI/10GE transceiver



For specifications about the supported inputs for SFP see chapter “Specifications”, page 177.

### LED behavior

- The SYNC LED lit up ORANGE when valid input sync is detected.
- The SEL LED lit up GREEN when the input is selected.

### Use cases

The SFP can be configured as follows:

1. SFP+ transceiver + Fiber connection (integrated or separated)
2. Neutrik OpticalCon Duo + SFP+ transceiver + internal fiber
3. Neutrik OpticalCon Quad + SFP+ transceiver + internal fiber
4. Loop-through mode



See projector installation manual for detailed instructions on how to install/configure the SFP input.



**WARNING:** Only by Barco trained and qualified technicians are allowed to install the SFP input.



Optical Transceiver to comply with Laser Class 1, IEC60825–1: 2014

# GUI – Introduction

# 5

5.1	Overview .....	48
5.2	Navigation.....	51
5.3	Test Patterns .....	53

## About this chapter

This chapter gives an general overview of the Graphic User Interface.

## 5.1 Overview

### Disclaimer on GUI images used in this manual

The GUI images in this manual are example illustrations and should be treated as such. While the name of the projector displayed in the illustrations may be different from the projector model you are currently using, the menu lay-out and functionality is identical.

### GUI – First start of the software

When you start the projector for the first time, you will be requested to choose the system language. You can choose between the following languages:

- German (DE)
- English (EN-US)
- Spanish (ES)
- French (FR)
- Japanese (JA)
- Korean (KO)
- Portuguese (PT-BR)
- Russian (RU)
- Chinese (ZH)



Image 5-1 Example of the welcome screen

Once you confirmed your choice, you will be prompted with the **Pulse product-specific End User License Agreement (EULA)**. You will only be able to access the projector software once you have fully read and approved the EULA.

### GUI – Product Registration

Upon first startup you will be requested to register the projector. You can perform the registration procedure now, or choose to *Register Later*. For more information on the entire registration procedure, refer to the Projector Registration user guide.



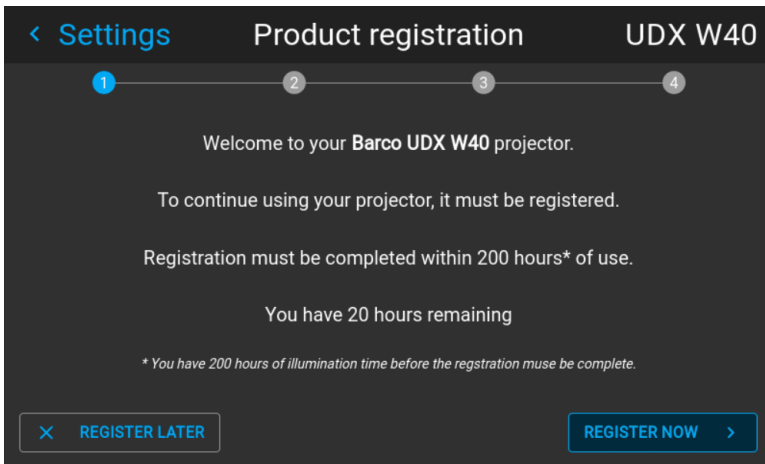

Image 5–2 Example of the Product registration form

### GUI – Status Screens

While the projector menu is not active, or the projector is Ready or Standby mode, the Status screens remain visible. These screens give an overview of the state of the projector and can be navigated through using the left and right arrow keys, or by swiping the screen left or right. The status screens are the following:

- **Dashboard:** The main overview. This screen displays all the chosen options on the projector (chosen source, blending/masking, display mode, etc).
- **About:** General info about the projector. This includes serial number, software version, mounted lens and light source runtime. It also includes altitude, and the pitch and roll tilt angles.
- **Notifications:** The error and/or warning messages that are currently active. If no messages are active, this list will be empty.
- **Preview:** A preview pane of the projected image. If no image is being projected, a test image is displayed instead.

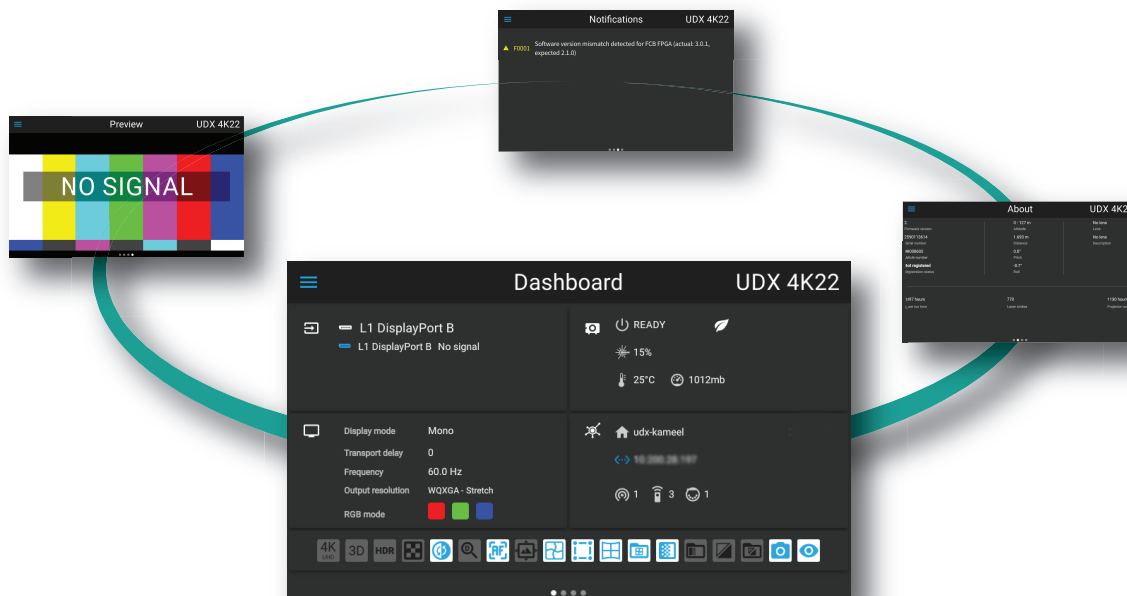

Image 5–3 Example of a Dashboard status screen

### GUI – Main Menu overview

The projector on-screen display (OSD) is the primary user interface (UI). From here, you can review and adjust all projector and display settings.

The OSD interface uses buttons to display the main menu. Each main menu contains submenus.

The OSD can be disabled by pressing the OSD on/off button.

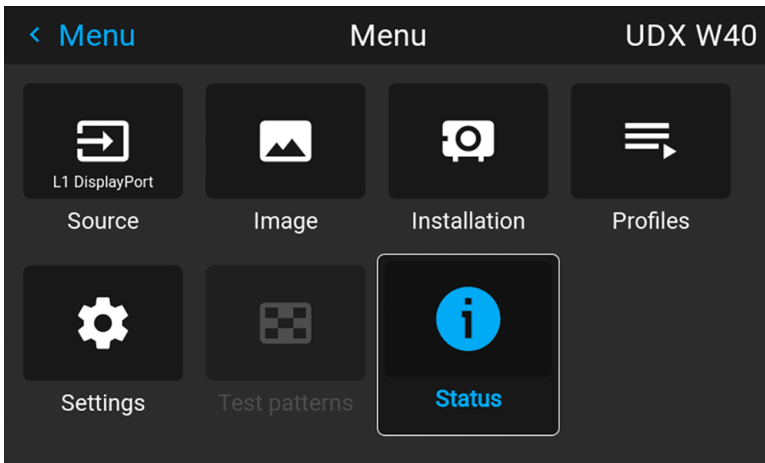

Image 5-4 Example of the home menu

The projector software platform uses access levels what each user can do. A standard user has access to the standard projector functionality. A certified service technician has also access to the advanced settings menu. This menu is password protected. This password can only be obtained by following the service partner training.

## GUI – Pulse software menu tree

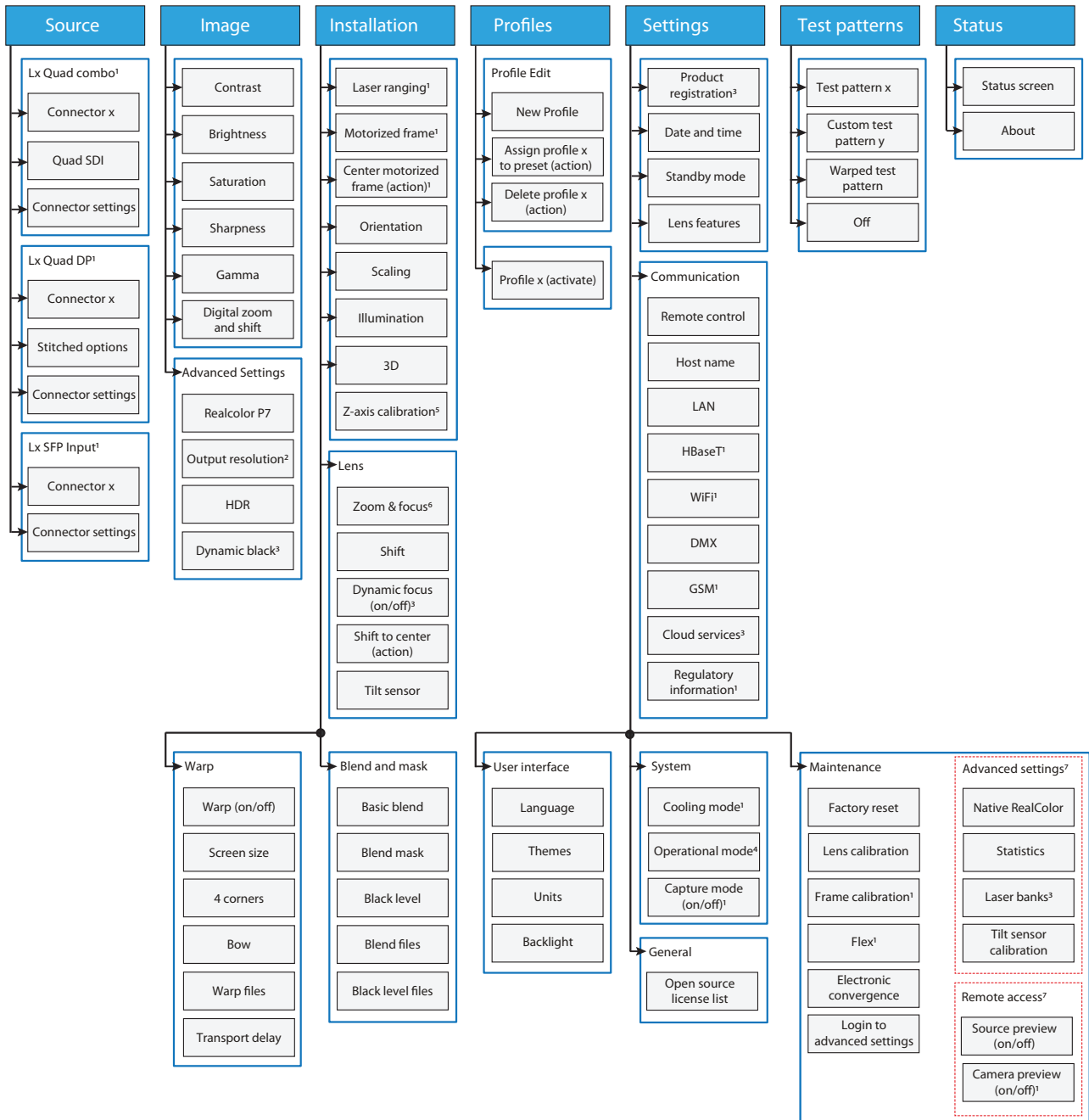

Image 5–5 Menu tree of the Pulse software, with the following footnotes

- 1** Only visible if specific option is installed
- 2** Only visible on 4K models with actuators
- 3** Only visible on UDX & UDM
- 4** Only visible on UDM
- 5** Only visible on HDX4K
- 6** Only visible when motorized lens is installed
- 7** Only visible when logged in as service user

## 5.2 Navigation

### Navigation via the RCU or local keypad

Navigating the OSD can be done using the remote control or the local keypad.

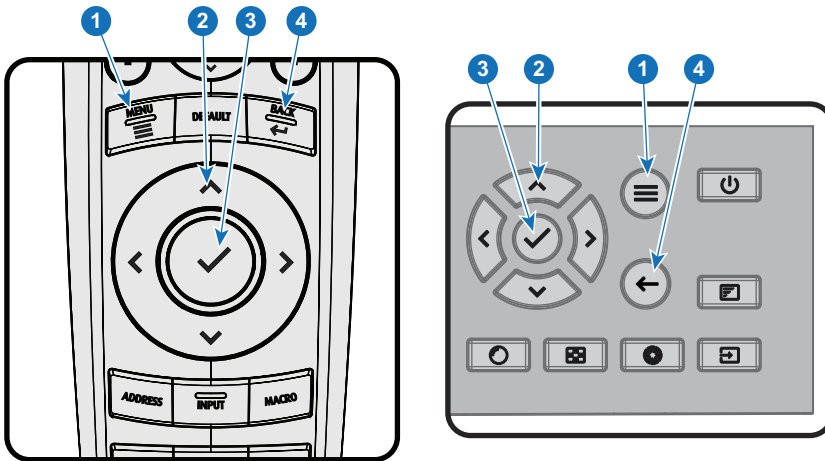

Image 5-6

To start up the menu structure, press **MENU** (1).

Use the arrow keys (**Menu Navigation** buttons) to navigate to the desired menu item (2). The background color changes to light blue.

Press the **Menu Selection** button (center key of the arrow keys), also called **OK** button, to activate that item and to jump one level deeper (3).

Use the numeral keys to enter values, or use the arrow keys to move the bar scale up or down.

Press the **Back** button to go up one level (4).

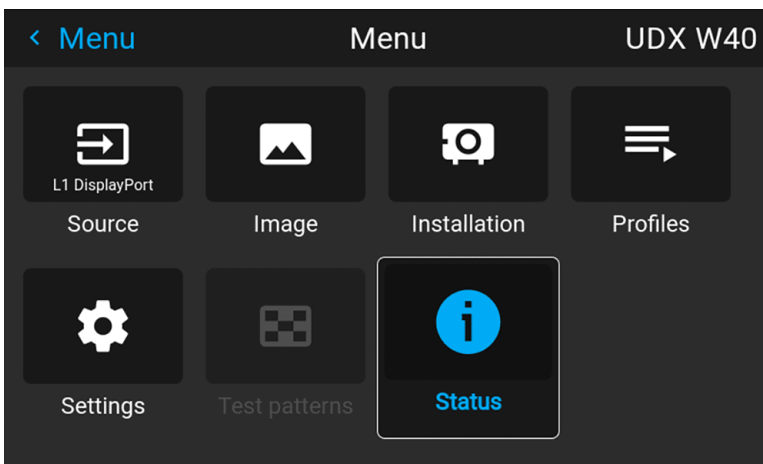

Image 5-7 Example of the home menu

Remark: a blue slider bar on the right side of the window means that there are more items to show than those currently displayed.

## Define values

Menu settings are displayed using check boxes, bar scale sliders, and drop-down lists.

To set a value:

- Press **OK** to select or deselect a checkbox (turn a function ON or OFF).
- Use the arrow keys to move the bar scale slider up or down on the value line. For a bar scale 0-9, each step will equal 10% of the total value.
- To enter the value as a direct number, press **OK**, input the digit(s), and then press **OK** again to execute and exit cursor mode e.g. OK 79 OK.

Within an input field, use the \* button as backspace button to remove an entered digit. Use the # button to enter a dot (.).

Changes to values are implemented dynamically.

To enter values with the local keyboard, use the arrow keys to select the first digit, press **OK**. Select the second digit and press **OK**. Continue until all digits are entered. Close the action by selecting the **enter** (↵) button and press **OK**. Select the **backspace** button and press **OK** to remove the last entered digit.

## Using the LCD touch display

From Pulse software 2.0 onward, the touch display functionality of the LCD panel has been activated and can be used.

Instead of using the remote control buttons or keypad keys or button, you can now:

- Touch menu icons to enter the respective menu.
- Swipe a menu up and down if not all information is not immediately visible (e.g. more than 8 (sub)menu icons being visible)
- Return to a higher menu level, by touching the blue name in the top left corner of the display.
- Use touch functionality to use menu items (check boxes, sliders, digital keyboard or keypads, etc).
- Swipe menu panes left or right when multiple panes are available (e.g. the Status menu)

## Menu memory

The OSD menu remembers the last selected sub-item as long as the projector is running. The menu memory is reset when restarting the projector from standby.

# 5.3 Test Patterns



## List of standard test patterns

The test patterns that are available by default are the following:

- Aspect
- Focus-Green
- Focus-bursts
- White / Black/ Red / Green / Blue
- Cyan / Magenta / Yellow
- Color bars
- Color gradients
- Checkerboard
- Cross hatch
- Geometry
- Horizontal gray bars
- Vertical gray bars
- 3D Stereo

## About the test pattern types

There are three types of test patterns possible in the projector:

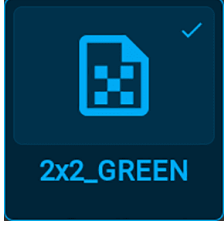
Type	Explanation	Example of test pattern icon
<b>Standard test patterns</b>	Standard test patterns. See previous list to see all test patterns available for your device.	
<b>Warped test patterns</b>	Available from software 2.2 onward. Every test pattern will have a “warped” variant available, symbolized with a “warp” symbol on the top-left corner of the icon. If active and configured, the warping will be applied to this test pattern. If warping is not active, or not configured, this will be identical to the standard test pattern.	
<b>Custom test patterns</b>	If uploaded via an external tool, you will find your custom uploaded test patterns (and its warped variant) at the bottom of the list of available patterns. All custom uploaded test patterns will be marked with the default “test pattern file” icon.	

## How to use test patterns

1. In the main menu, select *Test Patterns*.

or

Push the *Test Patterns* button on the RC.

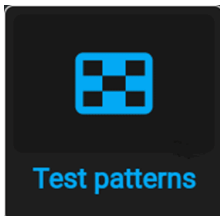

Image 5–8 Main menu, Test patterns

2. In the Test pattern menu, select the desired test pattern from the list.
3. To turn the test pattern off, select *off* instead.

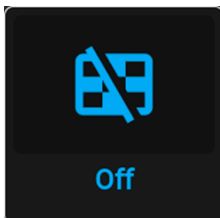

Image 5–9 Test patterns menu, test pattern off

# GUI – Source

# 6

6.1	Displaying a single source .....	56
6.2	Displaying multiple sources: Stitched layouts .....	56
6.3	Connector Settings .....	58

## About the Source menu

This menu is used to select, review and configure sources into the projector.

## 6.1 Displaying a single source

### About selecting a source

Before a source can be projected, the source signal must be connected to the source input(s) of the device and a valid synchronization signal must be available along with the source signal on at least one of the input connectors.

### How to select?

1. Press **Menu** to activate the menus and select *Source*.

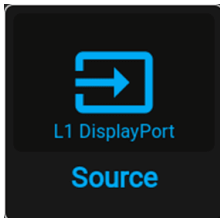

Image 6–1 Main menu, Source

2. Press **OK**.

The *Select Source* menu is displayed with the actual available sources filled out.

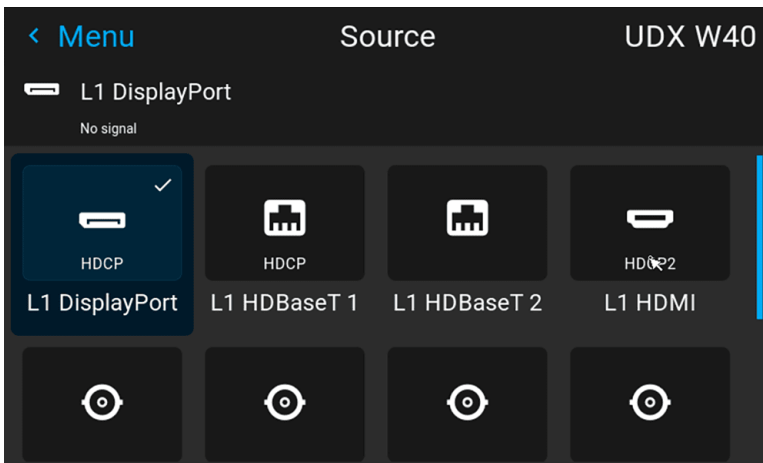

Image 6–2 Example of the input selection menu

3. Select the desired input.

## 6.2 Displaying multiple sources: Stitched layouts

### About stitched layouts

The first time you use a selected single source, the source will be displayed in the projector's native resolution. If the resolution of the source is different to the projector's resolution, the image is stretched or shrunk.

It is however possible to configure and display two or four source signals to make up one single image in full native resolution. This is called a **Stitched Layout**: the sources are stitched together.

The following table lists which stitched layouts you can use, and in which display mode these layouts can be used.

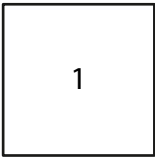
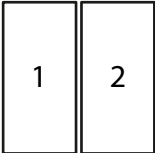
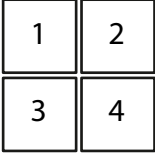
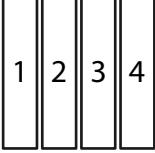
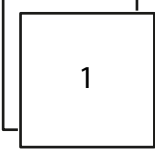
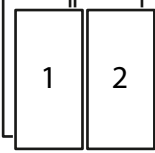

The table below describes the different Stitch Layouts and scan directions.

Type of layout	Description	Available connectors	Mode
 : Single	A single source is displayed in full screen	Quad Combo input: <ul style="list-style-type: none"> <li>• SDI (4x)</li> <li>• HDBaseT (2x)</li> <li>• DisplayPort</li> <li>• HDMI</li> </ul> Quad DP 1.2 Input: <ul style="list-style-type: none"> <li>• DisplayPort (4x)</li> </ul>	Mono / Active stereo
 : Dual 1 x 2	Two inputs are required. The sources are displayed next to each other.	Quad DP 1.2 Input: <ul style="list-style-type: none"> <li>• 2x DisplayPort</li> </ul>	Mono / Active stereo
 : Quad 2 x 2	Four inputs are required. The sources are displayed in four quadrants.	Quad Combo input: <ul style="list-style-type: none"> <li>• 4x SDI input</li> </ul> Quad DP 1.2 Input: <ul style="list-style-type: none"> <li>• 4x DisplayPort</li> </ul>	Mono / Active stereo
 : Quad 1 x 4	Four inputs are required. The sources are displayed next to each other.	Quad DP 1.2 Input: <ul style="list-style-type: none"> <li>• 4x DisplayPort</li> </ul>	Mono / Active stereo
 : 2 x single	Two inputs are required. The sources are displayed one above the other.	Quad DP 1.2 Input: <ul style="list-style-type: none"> <li>• 2 x DisplayPort</li> </ul>	Passive stereo
 : 2 x Dual 1 x 2	Four inputs are required. Two sources are displayed next to each other, while the other two are displayed above the first two	Quad DP 1.2 Input: <ul style="list-style-type: none"> <li>• 4x DisplayPort</li> </ul>	Passive stereo

 Even if passive stereo sources are selected, the output of this projector can only be in either 2D or in Active Stereo. Advanced image processing will make sure a passive stereo image is properly converted to active stereo.

### How to select a stitched layout

1. Press **Menu** to activate the menus and select *Source*.

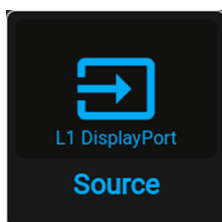

Image 6–3 Main menu, Source

2. Press **OK**.

The *Select Source* menu is displayed with the actual available sources filled out, including all available stitched layout options.

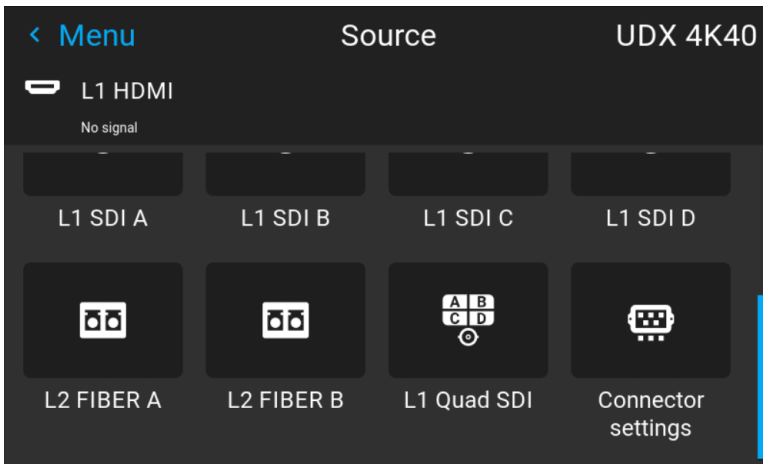

Image 6–4 Example of the stitched layout options

3. Select the desired stitched input.



*Tip:* If the Quad DP input board is installed, scroll all the way down the menu for the stitched options on that board.

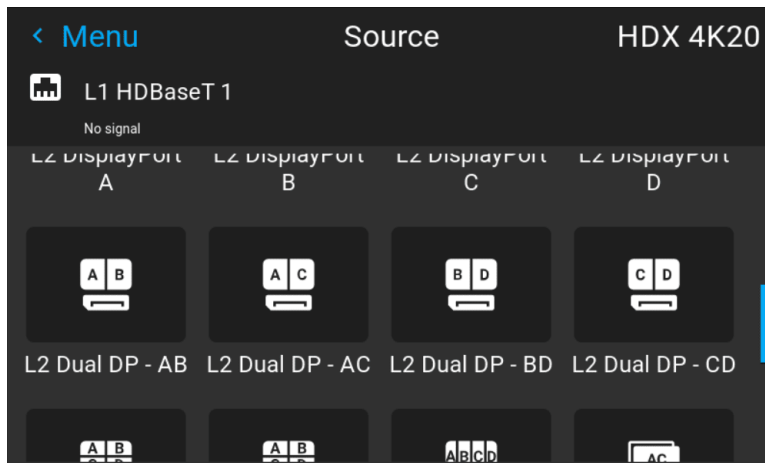

Image 6–5 Example of the stitched input options with the Quad DP board installed

## 6.3 Connector Settings

### About Connector Settings

The Connector Settings menu allows you to change settings for each input connector of the projector.

By default all options for every connector are set to automatic, together with the native Extended Display Identification Data (EDID).

When entering the menu for each input connector, you can change the following:

- Color Space
- Signal Range
- EDID

### How to configure a connector

1. Press **Menu** to activate the menus and select *Source*.



Image 6-6 Main menu, Source

2. Press **OK**.

The *Select Source* menu is displayed with the actual available sources filled out.

3. Scroll down to the bottom of the list of available sources and select *Connector Settings*.

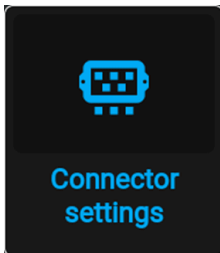

Image 6-7 Source menu, connector settings

The available input connectors are displayed.

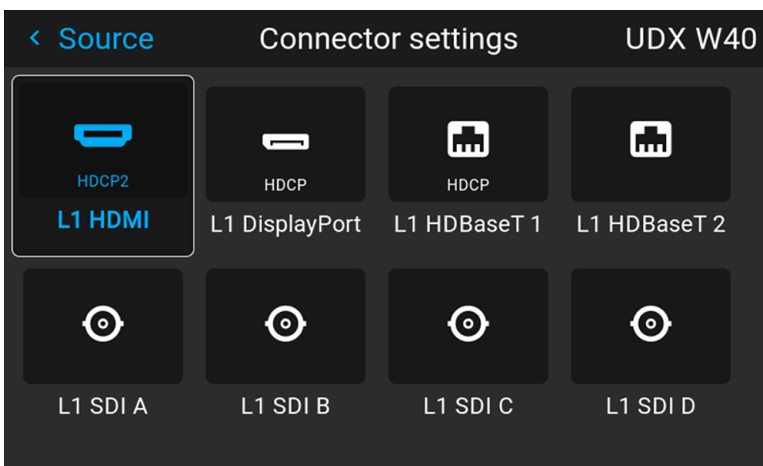

Image 6-8 Example of the Connector settings menu

4. Select the desired connector.

The **Connector Settings** menu for this connector will be displayed.

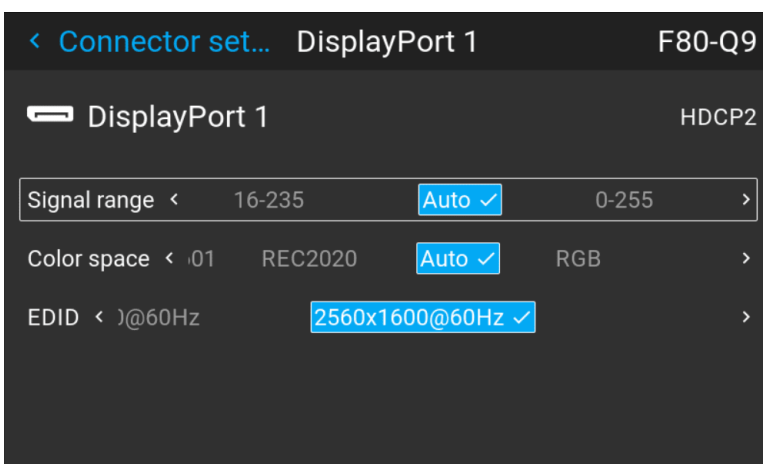

Image 6-9 Example of connector settings for an HDMI connector

5. You can change the following:

- To force a limit on the used signal range, select one of the available *signal ranges*.
- To force a limit on the color space, select one of the available *color spaces*.
- To set a video timing other than the one native for the connector, select one of the options under *EDID*.



*Note:* You cannot change the EDID for SDI connectors.

# GUI – Image

# 7

7.1	Setting image levels manually.....	62
7.2	Adjusting the sharpness .....	63
7.3	Adjusting the gamma correction.....	64
7.4	Setting the desired Gamma type .....	65
7.5	Digital Shift & Zoom .....	67
7.6	RealColor P7.....	71
7.7	Displaying HDR content .....	73
7.8	Dynamic contrast.....	74

## 7.1 Setting image levels manually

### Purpose

**Contrast:** Change the contrast of the complete output signal of the projected image.

**Brightness:** Change the brightness of the complete output signal of the projected image.

**Saturation:** Change the saturation of the complete output signal of the projected image.

### How to set up Contrast

1. In the main menu, select *Image* → *Contrast*.



Image 7-1 Image menu — Contrast

2. Use the ◀ or ▶ key to change the contrast enhancement until the desired value is reached (adjustable between 0 and 2).

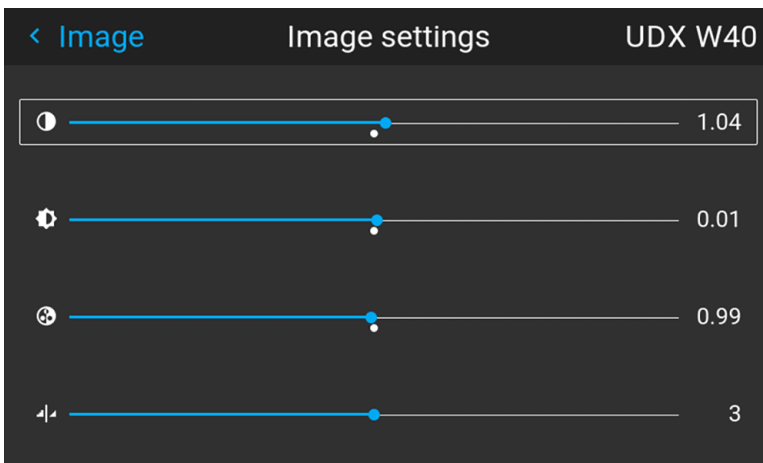

Image 7-2 Example of the image sliders, contrast is the first slider

3. If necessary, use the ▲ or ▼ key to select the other image adjustment options.

### How to set up Brightness Level

1. In the main menu, select *Image* → *Brightness*.

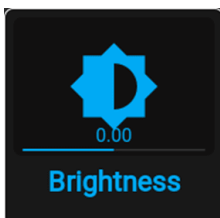

Image 7-3 Image menu — Brightness

2. Use the ◀ or ▶ key to change the brightness until the desired value is reached (adjustable between -1 and 1).

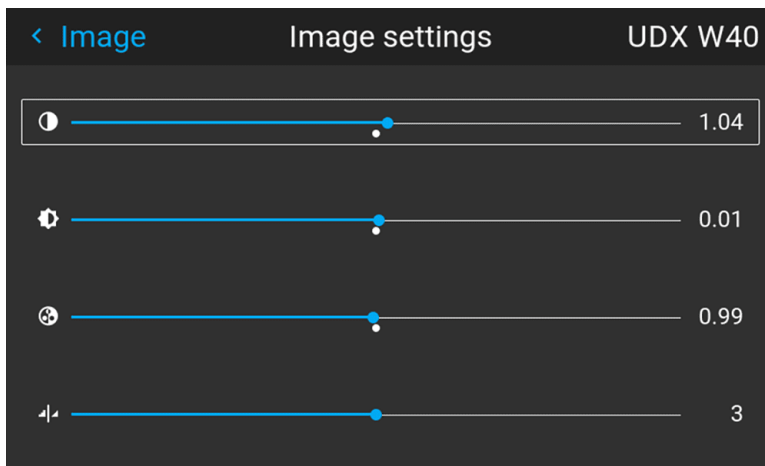

Image 7-4 Example of the image sliders, brightness is the second slider

3. If necessary, use the ▲ or ▼ key to select the other image adjustment options.

## How to set up Saturation Level

1. In the main menu, select *Image* → *Saturation*.

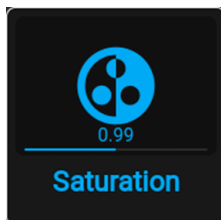

Image 7-5 Image menu — Saturation

2. Use the ◀ or ▶ key to change the saturation until the desired value is reached (adjustable between 0 and 2).

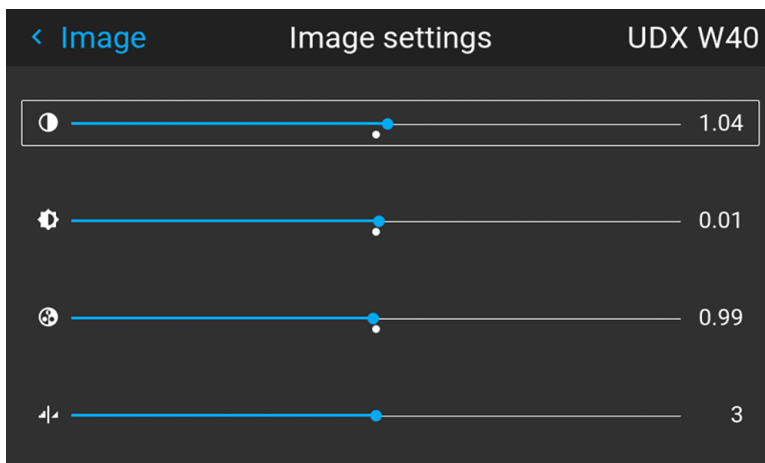

Image 7-6 Example of the image sliders, Saturation is the third slider

3. If necessary, use the ▲ or ▼ key to select the other image adjustment options.

## 7.2 Adjusting the sharpness

### About adjusting the sharpness

The sharpness adjustment amplifies the high frequency components in the picture. This means that by increase the sharpness, the picture will be perceived as sharper, and if decreased, the picture will be perceived as more blurry.

Increasing the sharpness will have the best effect in high contrast images, eg a table with text and borders. In a natural picture, high sharpness can be perceived as noise, as all details in the picture will be amplified. Available range: -2 to 8.

Default value: 0

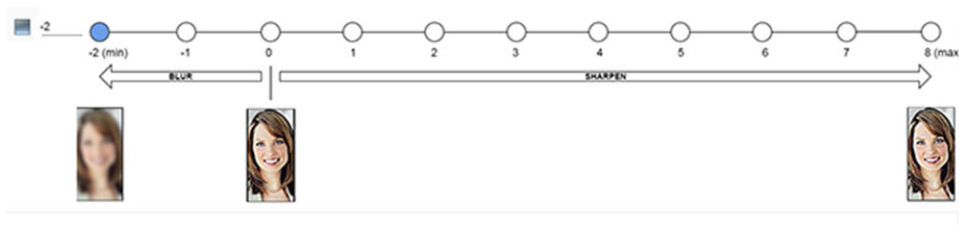

Image 7-7 Effect of sharpness adjust

### How to adjust

1. In the main menu, select *Image* → *Sharpness*.

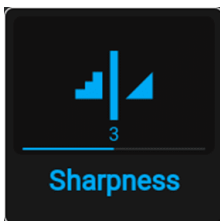

Image 7-8 Image menu – Sharpness

2. Use the ◀ or ▶ key to change the sharpness until the desired value is reached.

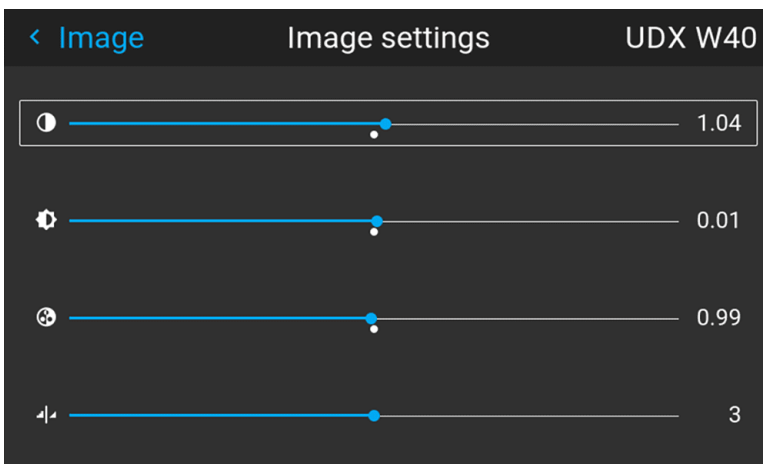

Image 7-9 Example of the image sliders, Sharpness is the bottommost slider

3. If necessary, use the ▲ or ▼ key to select the other image adjustment options.

## 7.3 Adjusting the gamma correction

### About gamma correction

Gamma correction is an image quality enhancement function that offers a richer image by brightening the already darker portions of the image without altering the brightness of the brighter portions (contrast feeling enhanced).

### How to adjust

1. In the main menu, select *Image* → *Gamma*.





Image 7-10 Image menu – Gamma

2. Use the ▼ key to select the slider.
3. Use the ◀ or ▶ key to change the gamma value between 1.0 and 2.8 . The default value is 2,2.



*Tip:* The slider can be adjusted with a precision of 0.1.

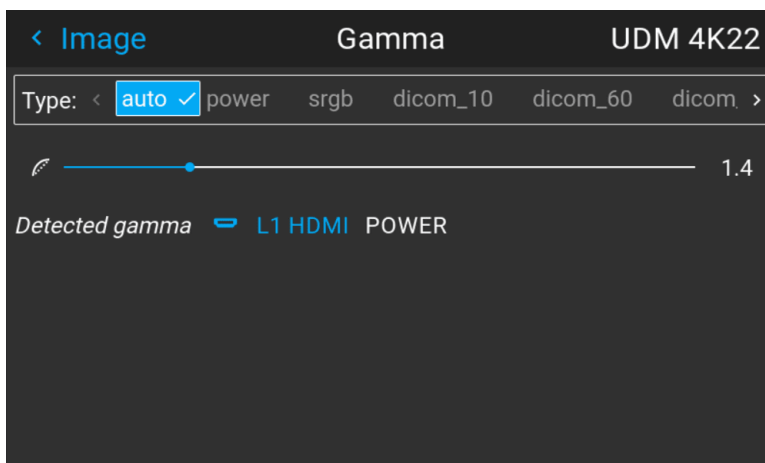

Image 7-11 Example of the gamma menu

## 7.4 Setting the desired Gamma type

### About the alternate gamma types

Next to the standard gamma correction, the projectors can be manipulated in a way to simulate gamma types for other devices or purposes. This includes sRGB (standard Red-Green-Blue), Power gamma, DICOM gamma ranges and for simulation projectors sim1.

DICOM gamma ranges are usually reserved for medical displays. While this projector is **not** a certified DICOM display, it can simulate certain specific DICOM gammas at a few selected max light outputs. The DICOM gamma assumes that both ambient light and the projector outputs black as 0 cd/m<sup>2</sup>. Then there will be a few predefined gamma curves at the following light outputs:

- DICOM 10: 10 cd/m<sup>2</sup>
- DICOM 60: 60 cd/m<sup>2</sup>
- DICOM 180: 180 cd/m<sup>2</sup>
- DICOM 250: 250 cd/m<sup>2</sup>
- DICOM 300: 300 cd/m<sup>2</sup>
- DICOM 400: 400 cd/m<sup>2</sup>



This is the full list. Take into account that the available DICOM gamma types for your projector type may be more limited than this list.

### Exception when using an HDR source

The only alternate color gamma that can not be selected in this menu is PQ/HDR. Because the color output of HDR is dependant on extra factors such as screen luminance, a separate menu has been made available for this (PQ).

If the source signal is HDR encoded an HDR icon will be visible next to the source signal. This is visible both in the Source selection menu, as well as the status menu.

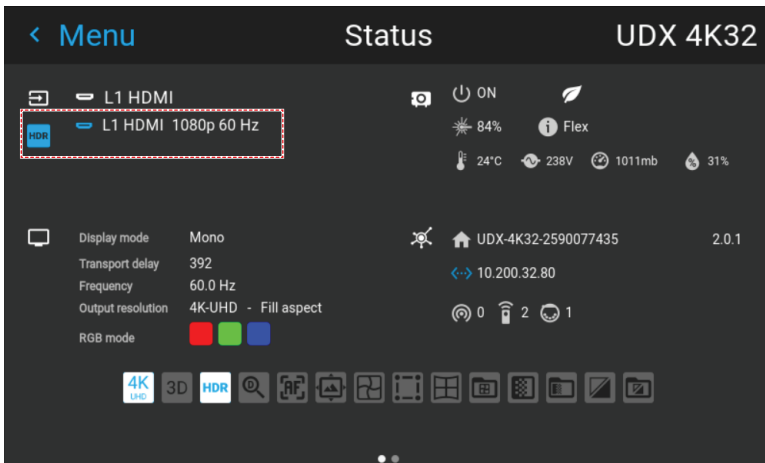

Image 7–12 Example of the HDR icon on the status menu

For more info on PQ and HDR, refer to “[Displaying HDR content](#)”, page 73.

### How to adjust the gamma type?

1. In the main menu, select *Image* → *Gamma type*.



Image 7–13 Image menu – Gamma

The Gamma type menu is displayed. If source content is available, the detected gamma of the source will be displayed at the bottom of the menu.

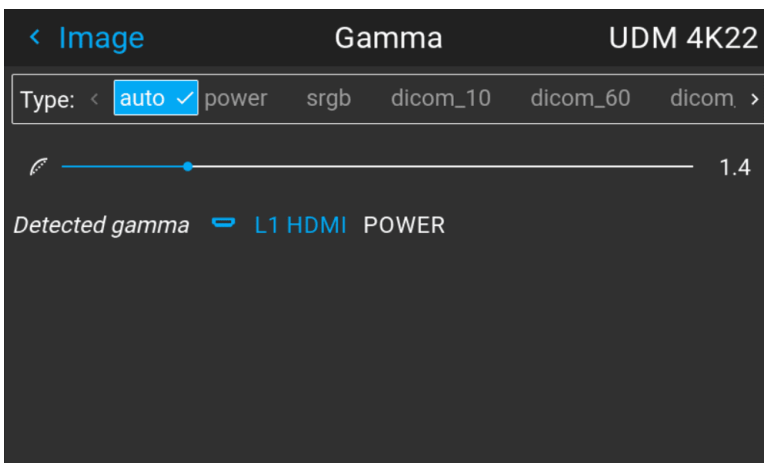

Image 7–14 Example of the gamma menu

2. Use the ◀ or ▶ key to select the desired gamma type and confirm.

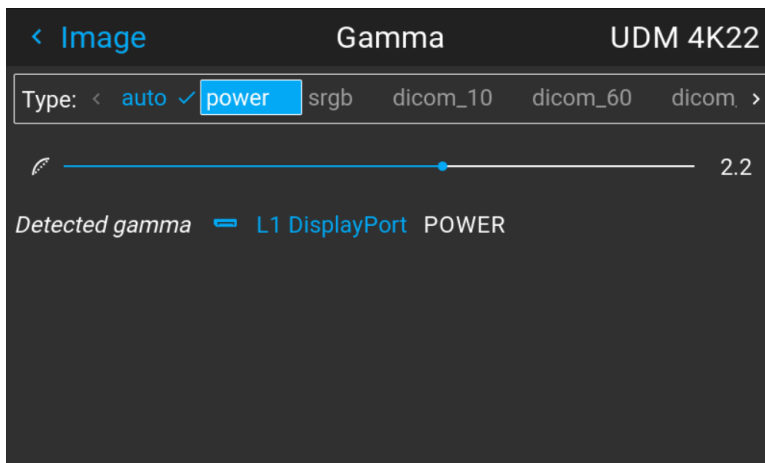

Image 7–15 Example of selecting a gamma type



**Tip:** If not sure what gamma type to select, keep the default value **auto** selected. This automatic mode will determine the used gamma type based on the incoming signal.

**However:** keep in mind when using the automatic mode, your media player needs to be configured correctly as well. While most mainstream media player devices will be configured correctly by default, we cannot guarantee this is the case for every device available on the market. If you notice the projected image seems “off”, it may be necessary to check the configuration of your media player. For more info, check the user guide of your media player device.

## 7.5 Digital Shift & Zoom

### What can be done?

The image can be optically shifted by using the vertical and horizontal lens shift.

If you want to reach a lens shift beyond what is possible with the optical shift, you can also perform a digital lens shift. This digital shift will occur on the DMD, rather than the lens holder. So take into account that this additional shift is minimal and restricted to the limits of the chip used.

For the optical zoom and lens shift, navigate to *Home* → *Installation* → *Lens*.



Lens shift is only possible when the used lens has been fully calibrated. To calibrate the current lens, navigate to *System Settings* → *Maintenance* → *Lens Calibration*.

### The effect of Digital Zoom

This function zooms in the picture digitally. When zooming in, the center of the image will increase in size. This means that the outer part of the picture will be outside the picture frame. When zooming out, the result is that the picture will be smaller than the projector's picture frame. The area outside the rendered picture will then be black.

For an example, see the following photos. The red lines in the figures represent the DMD outline.

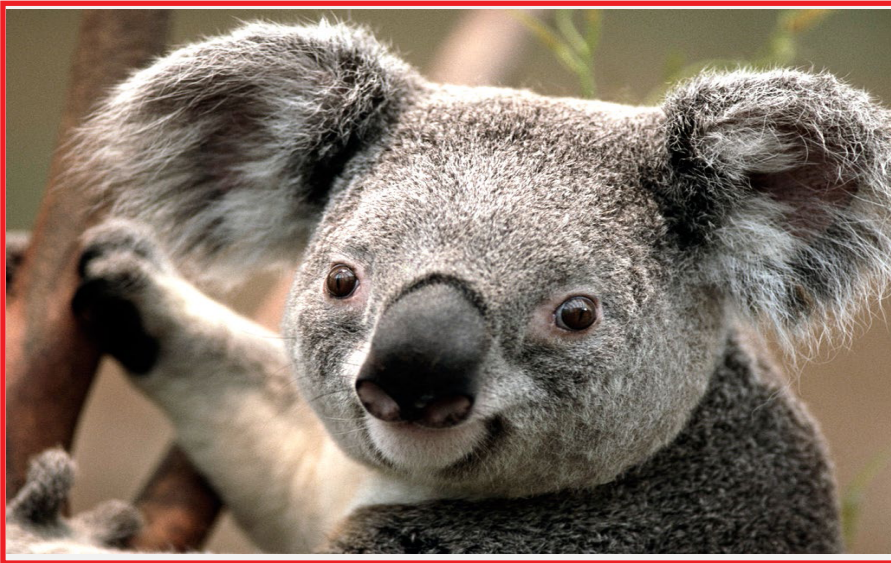

Image 7-16 Originally picture, not digitally zoomed



Image 7-17 Picture digitally zoomed in

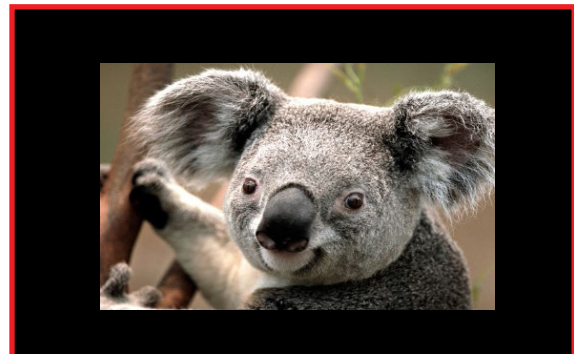

Image 7-18 Picture digitally zoomed out

### The effect of Digital Shift

This function will shift the picture digitally, meaning that the picture will be moved in any direction. As a result, some parts of the picture might be shifted outside the DMD range.

For an example, see the following pictures. The red lines in the figures represent the DMD outline



Image 7–19 Original Picture, not digitally shifted



Image 7–20 Picture shifted horizontally

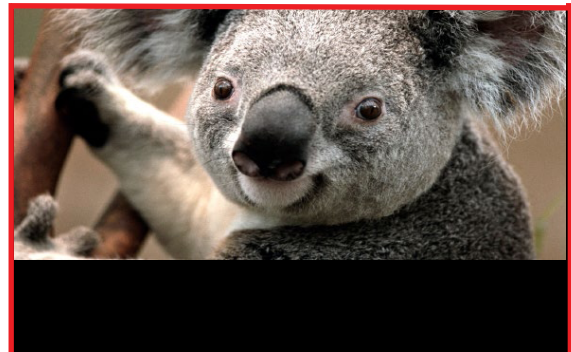

Image 7–21 Picture shifted vertically

## Digital Shift & Zoom

1. In the main menu, select *Image* → *Digital Zoom Shift*.

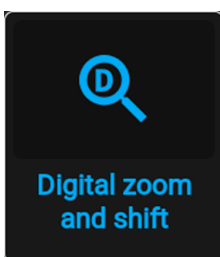

Image 7–22 Image menu, digital zoom and shift

The Digital Zoom Shift menu is displayed.

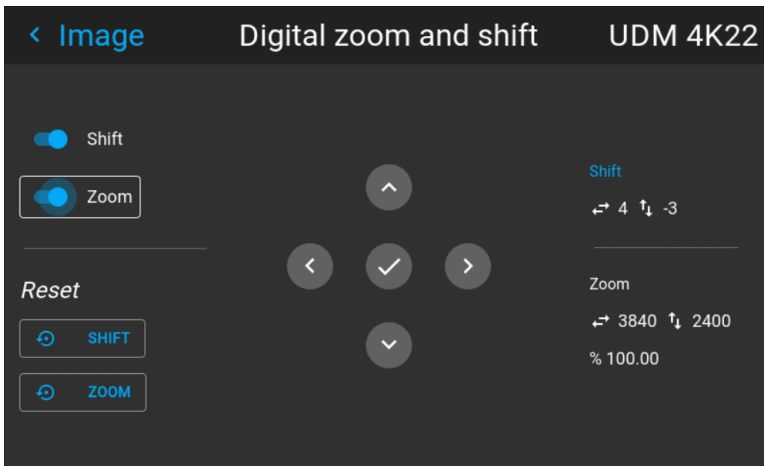

Image 7–23 Example of the digital zoom and shift menu

2. In order to optimize the digital zoom, enable the **Zoom** slider. In order to optimize the digital shift, enable the **Shift** slider.
3. When one or both of the modes are enabled, use the arrow keys to select the mini-keypad in this menu. Use the **enter** key to activate this mini-keypad.

If digital shift is enabled, the keypad will transform into the keypad for digital shift. If only digital zoom is active, it will automatically transform in they keypad for digital zoom.

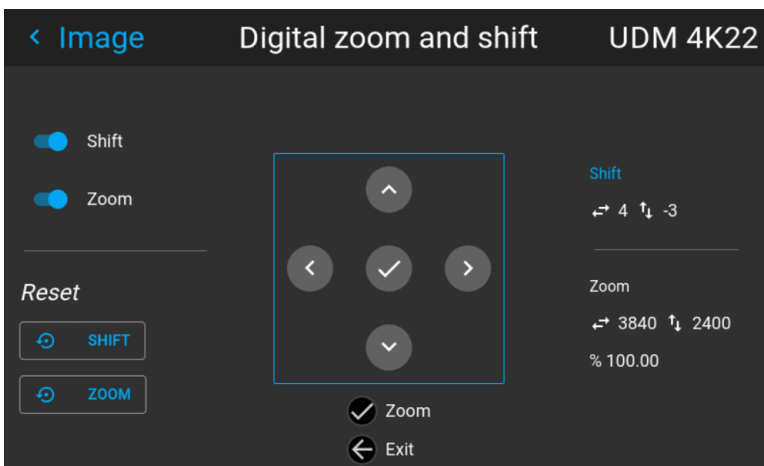

Image 7–24 Example of the enabled digital shift mode

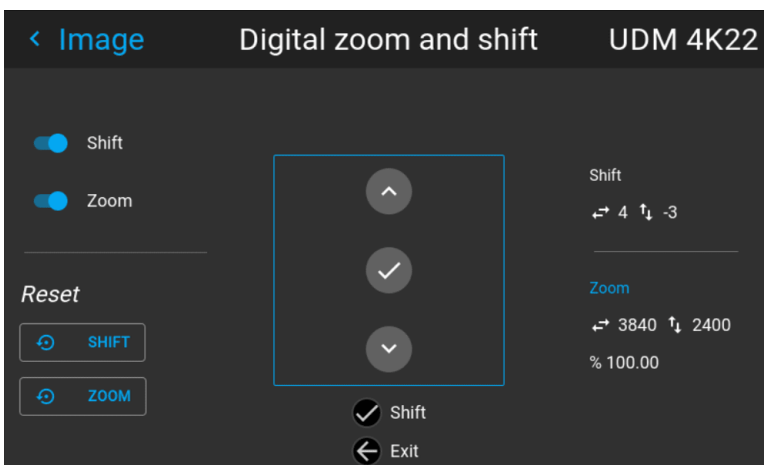

Image 7–25 Example of the enabled digital zoom mode

4. If digital shift is enabled, you can now do the following:
  - Use the ◀ or ▶ key to shift the lens (image) in horizontal direction.

- Use the **▲** or **▼** key to shift the lens (image) in vertical direction.
  - Use the **enter** key to transform the keypad to digital zoom mode (if enabled).
  - Use the **return** key to exit without saving.
5. If digital zoom is enabled, you can now do the following:
- Use the **◀** or **▶** key to zoom the lens in or out.
  - Use the **enter** key to either finish digital shift and zoom.
  - Use the **return** key to exit without saving.

## 7.6 RealColor P7

### Purpose

When blending images from multiple projectors, the measured color coordination of each projector can be altered to a desired common level. This so that the projected colors are identical over all projectors used.

Alternatively, if you are unfamiliar with how to adjust the colors to a specific setting, there are also a certain number of presets available, which forces the color output to specific color standards.

### How to set custom P7 values

1. In the main menu, select *Image* → *Advanced* → *RealColor P7*.

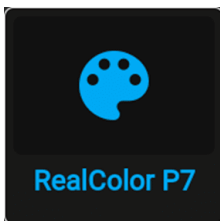

Image 7-26 Advanced settings menu – RealColor P7

The P7 menu is displayed.

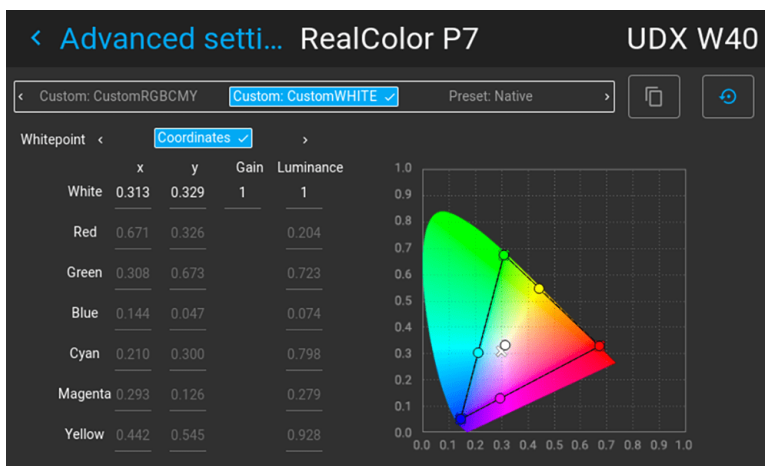



Image 7-27 Example of the RealColor P7 menu, here on a UDX

2. Select the desired *Custom Mode*. Select one of the following *Custom* options and confirm:
  - **Custom RGB**: 3–point color configuration.  
In RGB mode, the C, M and Y coordinates will be calculated automatically based on the R, G and B coordinates.
  - **Custom RGBCMY**: 6–point color configuration (both RGB and CMY).  
In RGBCMY mode, each color can be given a specific coordinate within the measured color triangle.
  - **Custom WHITE**: Configure only the White temperature.
3. Choose how to determine the *Whitepoint*. Choose one of the following:
  - **Coordinates**: Configure the white point via specific coordinates.  
The white point is specified using an x, y coordinate in the CIE 1931 Chart.

- **Temperature:** Configure the white point via a color temperature slider. The white point is specified on a Kelvin scale between 3200K and 13000K tracking along the black body curve.

4. Define the coordinates for each available color.

Click on a coordinate value and select the current value. Enter the desired value with the numeric keys.

 *Note:* You can only pick coordinates within the measured color triangle.



You can reset all coordinates to the default values (to native) by clicking the Reset icon.



## How to choose one of the P7 presets

1. In the main menu, select *Image* → *Advanced* → *Realcolor P7*.

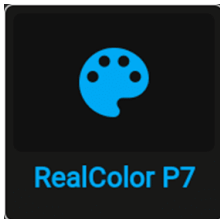

Image 7–28 Advanced settings menu – RealColor P7

The P7 menu is displayed.

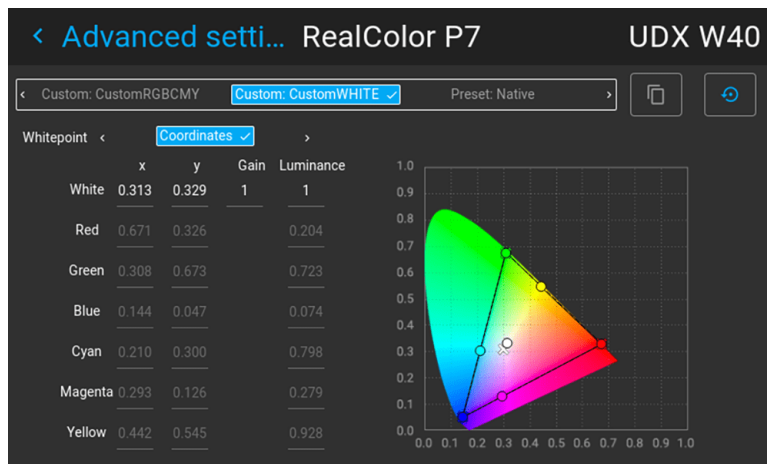

Image 7–29 Example of the RealColor P7 menu

2. Select one of the pre-defined presets:
  - **Standard:** A color standard for all UDX projectors, which may be considered the new native settings for all UDX projectors. Default for UDX.
  - **Native:** Projector native color settings.
  - **DCI-P3:** Color standard for Cinema.
  - **EBU:** European color standard for broadcasting.
  - **SMPTE-C:** American color standard for broadcasting.
  - **Rec. 709:** Color standard for high-definition televisions (HDTV).



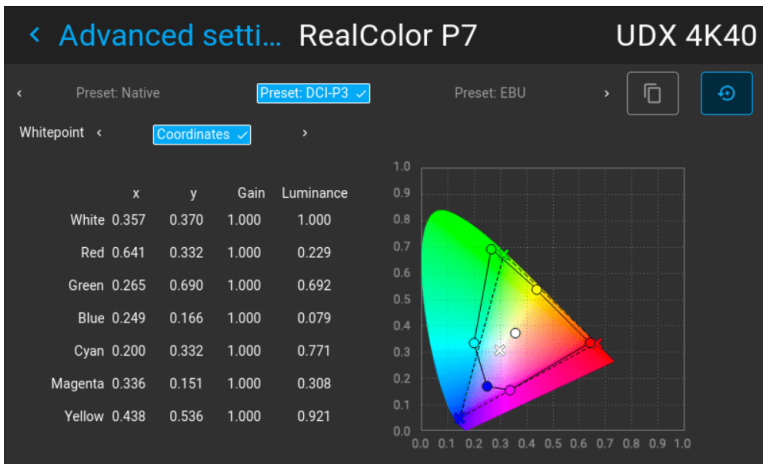

Image 7–30 Example of one of the presets, here DCI-P3

**Note:** After choosing one of the presets, you can still alter the values of the coordinates to your own choosing, similarly to how you set custom P7 values.

Use the **Reset** icon to return to the default values of the chosen preset.



## 7.7 Displaying HDR content

### About HDR and PQ

Perceptual Quantizer (PQ) is a non-linear electro-optical transfer function (EOTF) that allows for the display of High Dynamic Range (HDR) content with a luminance level of up to 10 000 cd/m<sup>2</sup> and can be used with the Rec. 2020 color space.

### When do I know my content is HDR encoded?

If the source signal is HDR encoded, an HDR icon will be visible next to the source signal. This is visible both in the Source selection menu, as well as the status menu.

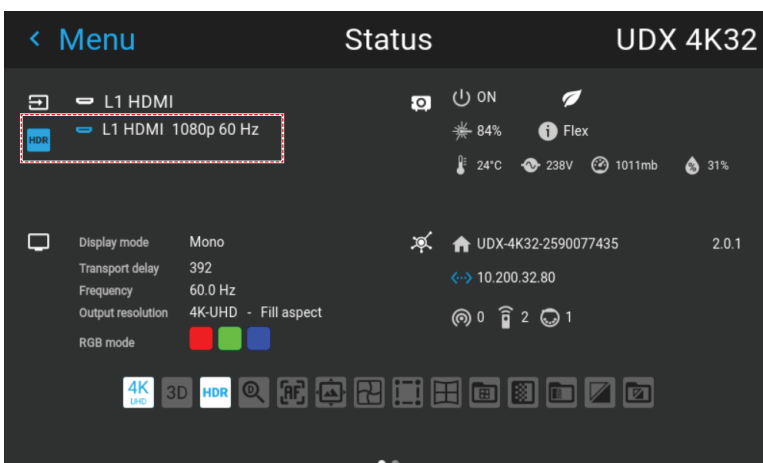

Image 7–31 Example of the HDR icon on the status menu

### How to properly display HDR content?

If your provided HDR content has been mastered with PQ (e.g. HDR10 and Dolby Vision), a few changes can be made in order to project the intended mastering on screen. These changes are necessary because HDR content has been mastered specifically for HDR capable displays that are watched in living rooms. These conditions are different from a non-HDR projector and darker cinema-like environments.

The projected HDR content depends on the following factors:

- **Mastering luminance:** This is content-specific and cannot be changed.
- **Screen luminance:** Every projection screen has a specific luminance (measured in nits or foot-Lambert). Entering this luminance in the projector will adapt the content towards the intended HDR result.
- **HDR Boost:** A variable “booster” that may amplify or downplay the HDR output.

## How to set the HDR-related parameters?

1. Make sure the chosen Gamma Type is set to *AUTO*. For more info, refer to “[Setting the desired Gamma type](#)”, page 65.
2. In the main menu, select *Image* → *Advanced* → *HDR*.



Image 7–32 Advanced settings menu, HDR

The HDR menu is displayed.

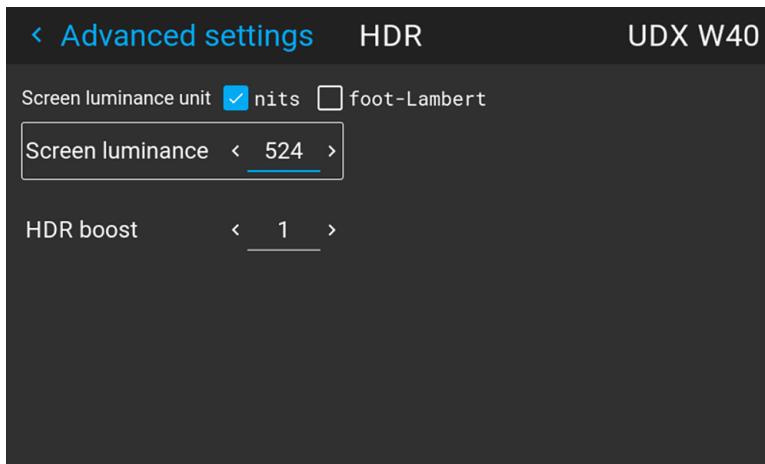

Image 7–33 Example of the HDR menu

3. Select the desired *Screen luminance unit* (nits or foot-Lambert).
4. Enter the *Screen luminance* (which is measured in nits or foot-Lambert).
5. Alter the *HDR boost* if necessary. You can modify this value to somewhere between 0.8 and 1.2.

## 7.8 Dynamic contrast

### About dynamic contrast

Projectors rely on contrast to showcase dark scenes or black parts on the projected surface. Whites and light areas are usually projected without issue, but blacks and dark areas are a different matter. With low contrast, blacks and dark areas appear more grey. The dynamic contrast menu is here to improve the dark scene accuracy.

Dynamic contrast checks the projected content dynamically and adapts the power of the light source accordingly to create the best possible outcome.



Take note that dynamic contrast isn't magic. Adapting the light source to adapt its contrast according to the played content will have an impact on the total light output of the projector. If you do not care about this feature and want your projector to display the brightest possible content instead, you can turn this feature off.

## How to set the dynamic contrast?

1. In the main menu, select *Image* → *Advanced* → *DynaBlack*.

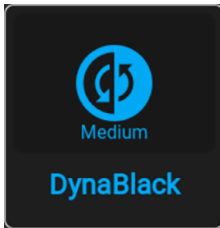

Image 7–34

The DynaBlack menu is displayed.

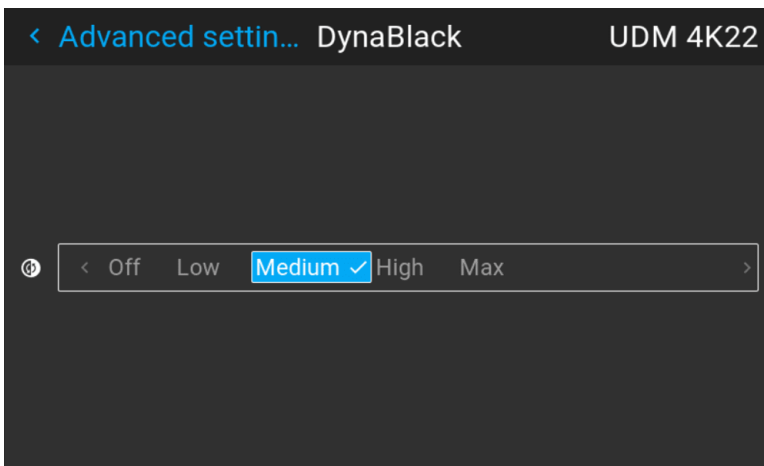

Image 7–35 Example of the DynaBlack menu

2. Select the desired dynamic contrast setting, or leave the default on (medium).

The result will slowly become visible.



Do not panic if there isn't a visible change after a few seconds. Each change in the dynamic contrast menu has an impact on the light source, thus these changes will only become visible over time.



# GUI – Installation

# 8

8.1	Configuring the lens, optical zoom-focus .....	78
8.2	Configuring the lens, shift .....	78
8.3	Configuring the lens, dynamic focus .....	79
8.4	Configuring the lens, Shift to center .....	80
8.5	Configuring the lens, tilt sensor .....	81
8.6	Laser ranging .....	82
8.7	Manipulating the rigging frame .....	83
8.8	Manipulating the rigging frame, center position .....	85
8.9	Orientation .....	85
8.10	Scaling modes.....	86
8.11	Warping .....	87
8.12	Blending & masking .....	100
8.13	Illumination .....	110
8.14	3D projection.....	111

## 8.1 Configuring the lens, optical zoom-focus

### What can be done?

If a motorized lens has been mounted onto the projector, you can fine-tune the projected image.

### Zoom - Focus

1. In the main menu, select *Installation* → *Lens* → *Zoom focus*.

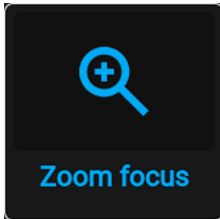

Image 8-1 Lens menu, Zoom & Focus

The Zoom and focus menu is displayed.

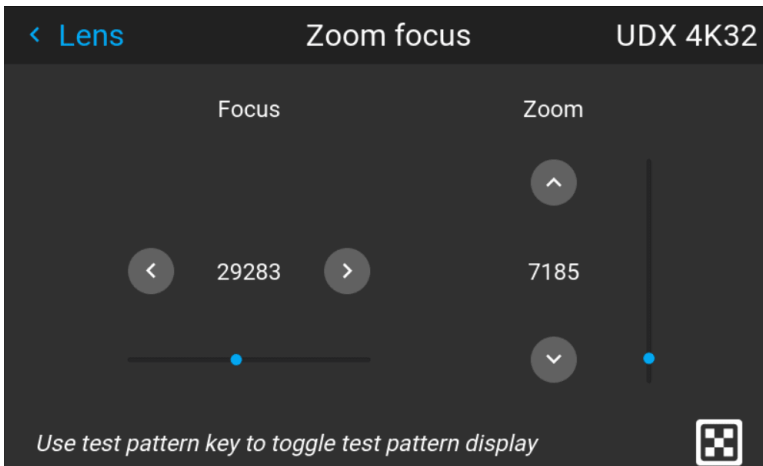

Image 8-2 Example of the zoom and focus adjustment menu

2. Use the ▲ or ▼ key to zoom the lens in or out.  
Use the ◀ or ▶ key to focus the lens to far or near.

## 8.2 Configuring the lens, shift

### What can be done?

The image can be optically shifted by using the vertical and horizontal lens shift.

If you want to reach a lens shift beyond what is possible with the optical shift, you can also perform a digital lens shift. This digital shift will occur on the DMD, rather than the lens holder. So take into account that this additional shift is minimal and restricted to the limits of the chip used.

For the digital zoom and shift, navigate to *Home* → *Image* → *Digital Zoom Shift*. For more info, see “[Digital Shift & Zoom](#)”, page 67.



Optical lens shift is only possible when the used lens has been fully calibrated. To calibrate the lens, navigate to *System Settings* → *Maintenance* → *Lens Calibration*.

### Vertical and Horizontal Shift

1. In the main menu, select *Installation* → *Lens* → *Shift*.

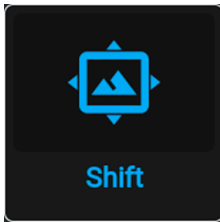

Image 8-3 Lens menu, lens shift

The Lens shift menu is displayed.

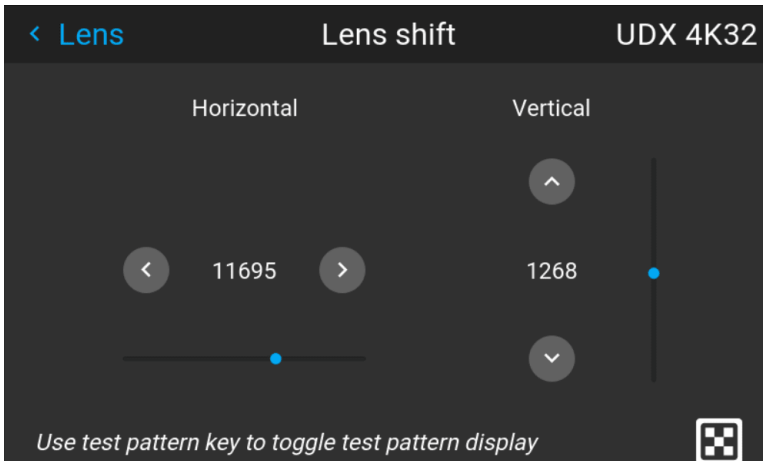

Image 8-4 Example of the lens shift menu

- Use the ◀ and ▶ keys to shift the lens (image) in horizontal direction.  
Use the ▲ and ▼ keys to shift the lens (image) in vertical direction.

## 8.3 Configuring the lens, dynamic focus

### About focus drift and dynamic focus

Due to the design of TLD+ lenses and ultra-short throw lenses (UST lenses), these type of lenses tends to heat up over time when used in projectors. This has the side-effect of a slight shift in focus between the lens in its cold state and the lens in its heated state, which is referred to as “focus drift”.

While there are external solutions available that perform a “focus drift compensation”, a dynamic focus feature has been implemented from Pulse software version 2.0 onward that handles this focus drift. While enabled, the projector will perform the necessary calculations in order to handle this drift in focus.



The amount of focus drift can differ between lenses. For that reason it is important to calibrate the focus drift when a new lens is mounted in the projector.

Use the calibration wizard in the Projector Toolset to calibrate focus drift. For more info on the focus drift calibration, consult the Projector Toolset user guide.

### How to enable dynamic focus?

- To enable dynamic focus mode, select *Installation* → *Lens*.

The Lens menu is displayed.

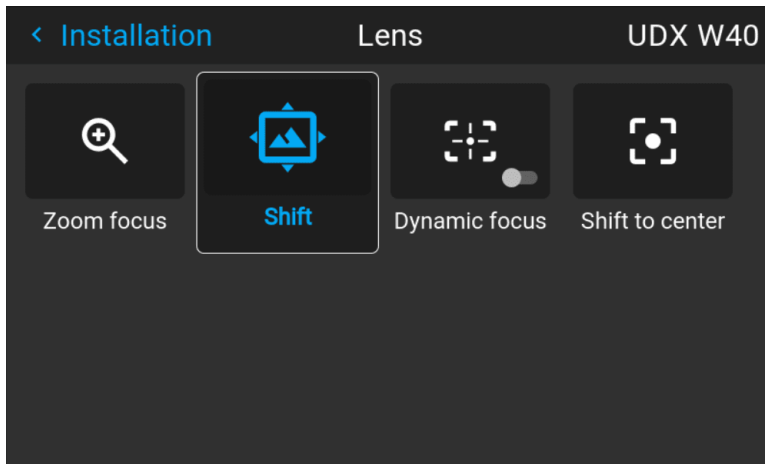

Image 8–5 Example of the Lens menu

2. In the Lens menu, click *Dynamic focus* to toggle between *On* and *Off*.

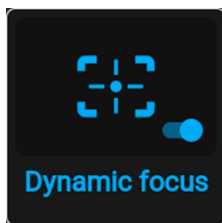

Image 8–6 Lens menu, Dynamic focus enabled

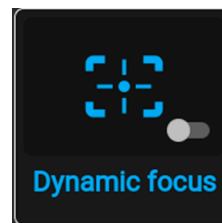



Image 8–7 Lens menu, Dynamic focus disabled

 *Note:* The *Dynamic focus* slider is only visible when the light source is on.

## 8.4 Configuring the lens, Shift to center

### What can be done?

The lens can be forced back to the center position by selecting **Shift to center**.

### How force lens in Mid position

1. To force lens in Mid position, select *Installation* → *Lens* → *Shift to center*.

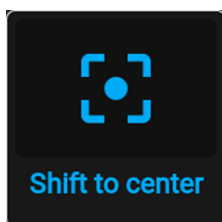

Image 8–8 Lens menu, Shift to center

2. Confirm by pressing the **CONFIRM** button.



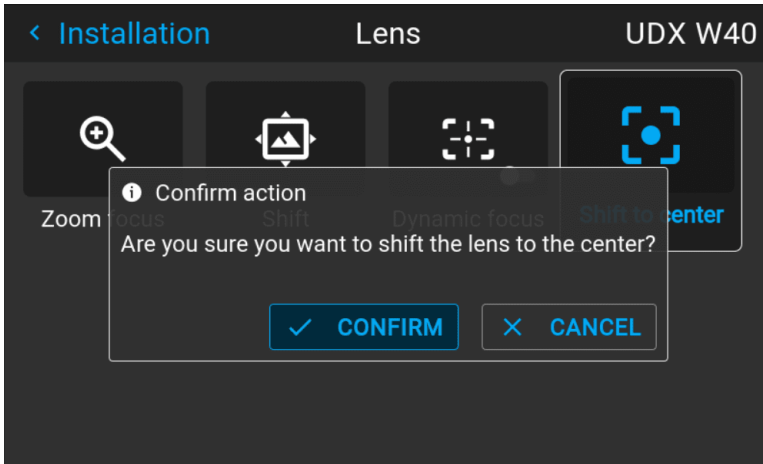

Image 8–9 Example of the Shift to center action

The lens will calibrate itself and return to the center position.

## 8.5 Configuring the lens, tilt sensor

### When to use the tilt sensor menu

The projector has a built-in tilt sensor that detects the angle at which the projector is mounted. If you are in a situation where you need to fine-tune the projector because you want to achieve a picture at a specific angle (e.g. perfectly level, or a perfect fit in a multi-projector setup), you can use the tilt sensor menu as an aide when adjusting the projector feet, rigging frame or other used mounting mechanisms.

### How to read the tilt sensor values

1. In the main menu, select *Installation* → *Lens* → *Tilt sensor*.

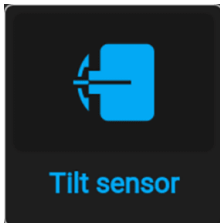

Image 8–10 Lens menu, Tilt sensor

The Tilt sensor menu is displayed.

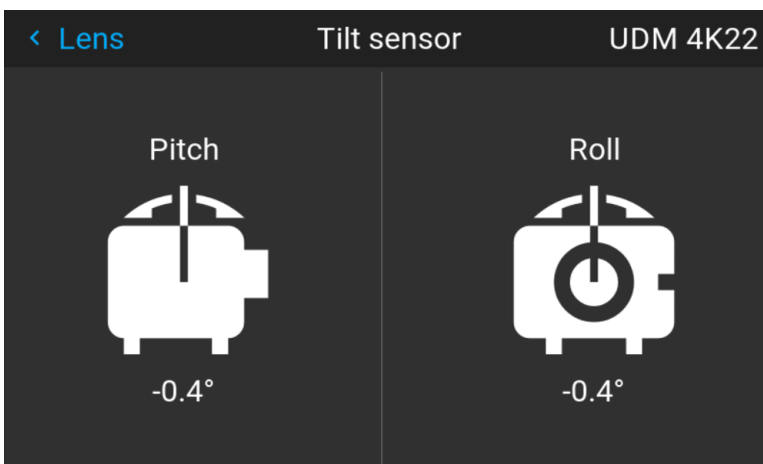

Image 8–11 Example of the tilt sensor menu



If you notice the tilt sensor isn't working correctly (e.g. when compared to a level), you can calibrate the sensor in the settings menu. For more info, see [“Advanced settings – Tilt sensor calibration”](#), page 163.

## 8.6 Laser ranging

### What can be done?

When the optional laser range finder is installed on the projector, you can use the laser source to measure the distance between the front of the projector and the surface you are projecting on.

This can help you fine-tune the position of the projector.



Take into account that while a laser ranging session is active, the projected image will be off. This to have no interference between laser pointer and projected image. Instead, a red border will be projected giving the outline of where the projected image should be.

### How to manipulate the laser range finder?

1. In the main menu, select *Installation* → *Laser ranging*.



Image 8–12 Installation menu, laser ranging

The Laser ranging menu is displayed.

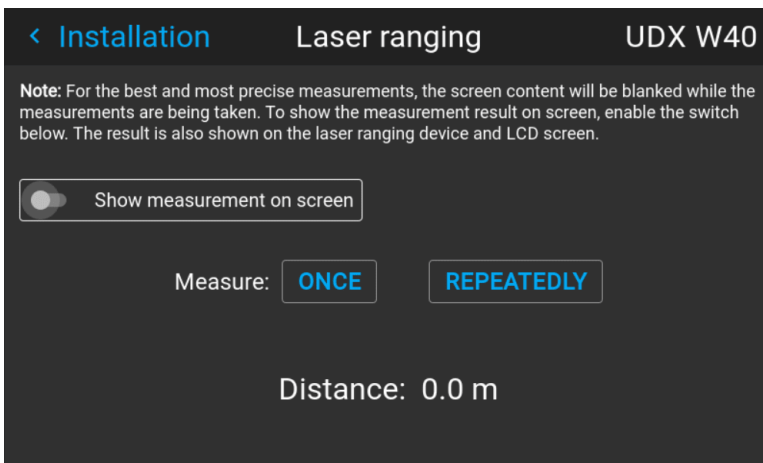

Image 8–13 Example of the laser ranging menu

2. For a single laser ranging calculation, press *Once*. This will continue the laser for 30 seconds.
3. If you want a continued laser ranging (e.g. when fine-tuning the position of the projector), press *Repeatedly*.
4. If you cannot see the display of the laser range finder while performing a laser ranging session, select *Show measurement on screen*. This way, the measurement will be projected alongside the laser dot and the red border.

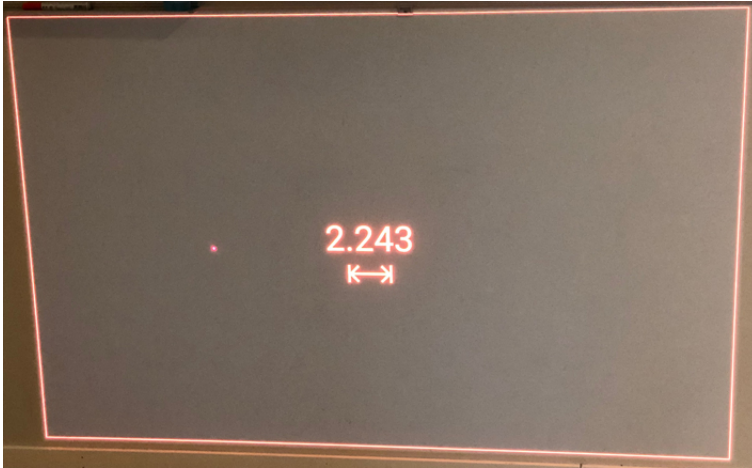

Image 8–14 Example of projected image during laser ranging session with measurement on screen



By default the measurement is in meters. If you want the distance projected in feet, you can change the measurement system in the System settings menu. For more info, refer to “[Units \(measurement\) system setup](#)”, page 138.

## 8.7 Manipulating the rigging frame

### When can you manipulate the rigging frame?

You can manipulate the rigging frame in the Pulse menu when:

- The projector is mounted in a motorized rigging frame.
- The wiring of the motorization is connected to the projector, including the XLR connector.
- The XLR connector is enabled and powered to 24V. For more info on how to power the XLR connector, see “[Front XLR output voltage control](#)”, page 135.

### How to manipulate the rigging frame?

1. In the main menu, select *Installation* → *Lens* → *Motorized frame*.

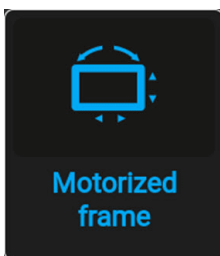

Image 8–15 Lens menu – Motorized frame

The Motorized frame menu is displayed.

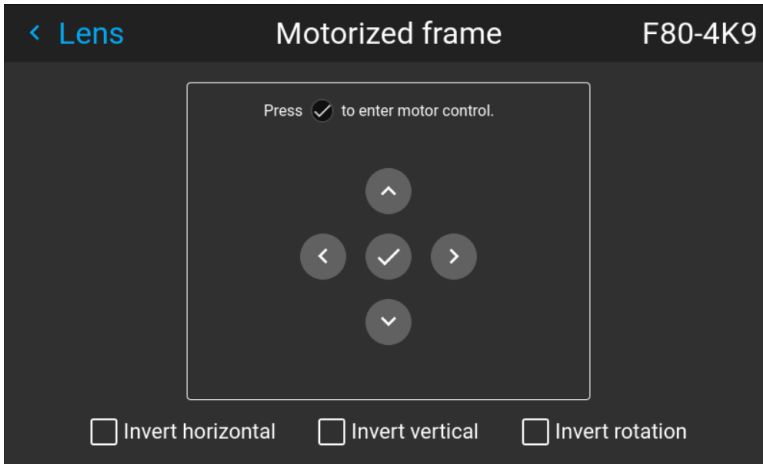

Image 8–16 Example of the Motorized frame menu

2. Press the OK key or button to activate the frame shift motors.

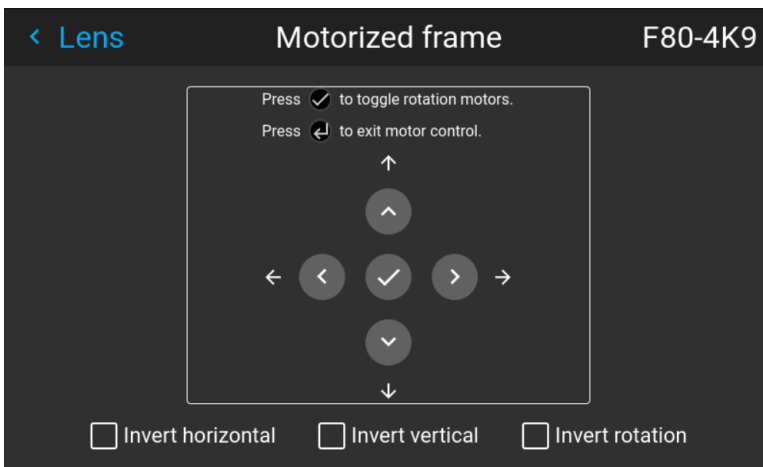

Image 8–17 Example of horizontal and vertical frame shift

3. Use the ▲ or ▼ button to shift the rigging frame (image) in vertical direction.  
Use the ◀ or ▶ button to shift the rigging frame (image) in horizontal direction.
4. Confirm with the OK button.  
The frame rotation menu is displayed.

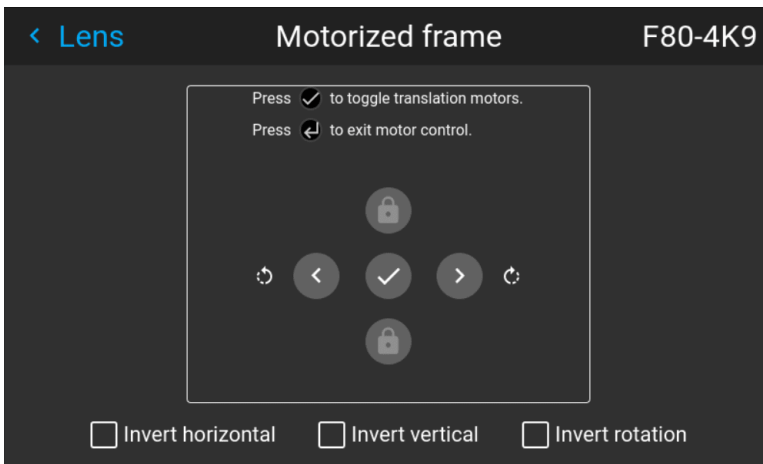

Image 8–18 Example of frame rotation

5. Use the ◀ or ▶ button to rotate the rigging frame (image) either clockwise or counterclockwise.
6. Confirm with the OK button to return to the frame shift menu, or use the Menu back button to return to the Lens menu.

## 8.8 Manipulating the rigging frame, center position

### What can be done?

The motorized frame can be forced back to the center position by selecting **Center motorized frame**.

### How to reset the motorized frame?

1. In the main menu, select *Installation* → *Lens* → *Center motorized frame*.

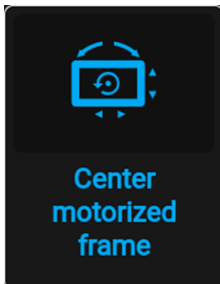

Image 8–19 Lens menu, Center motorized frame

A *confirm action* prompt will be displayed.

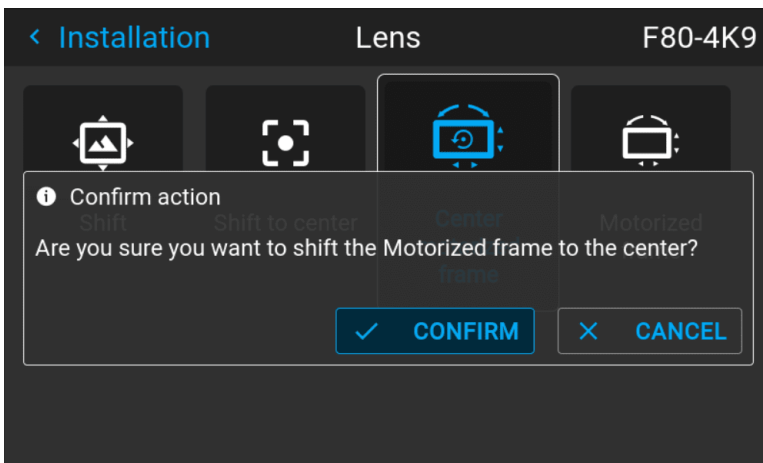

Image 8–20 Example of the Center motorized frame action prompt

2. Confirm to reset the frame to its center position.  
Wait until the frame motors have stopped before doing other actions.

## 8.9 Orientation

### What can be done?

The way of physical installation of the projector can be defined to the projector.

The following installation are possible:

- **Desktop front:** Projected image will not be flipped or mirrored.
- **Desktop rear:** Projected image will be flipped horizontally (left side switches to the right side).
- **Ceiling front:** Projected image will be flipped vertically (top side switches to the bottom side).
- **Ceiling rear:** Projected image will be flipped both vertically and horizontally.
- **Auto front:** The tilt sensor will detect if the projector is desktop or ceiling mounted and will project a readable image accordingly.
- **Auto rear:** The image will be flipped horizontally. The tilt sensor will detect if the projector is desktop or ceiling mounted and will project a readable image accordingly.

## How to set the correct orientation

1. In the main menu, select *Installation* → *Orientation*.



Image 8–21 Installation menu, orientation

The Orientation menu is displayed.

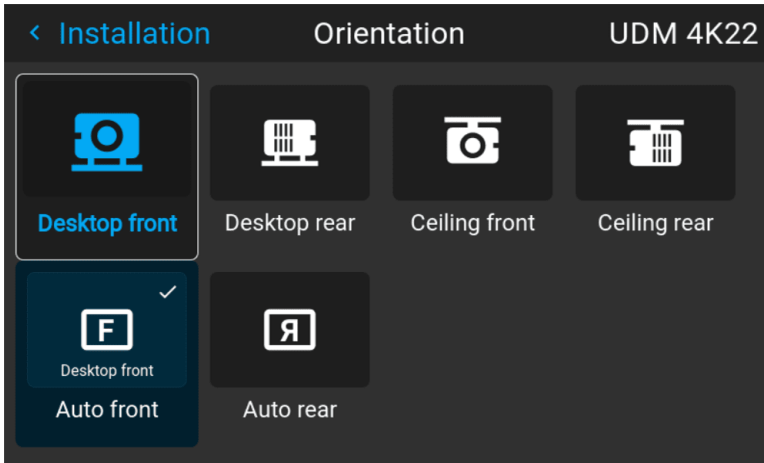

Image 8–22 Example of the orientation menu

2. Use the ◀ or ▶ keys to select the projector orientation mode and press **OK** to activate.

## 8.10 Scaling modes

### About scaling modes

While the default mode of projection is to fill the screen while respecting the aspect ratio (fill aspect), it is also possible to stretch the image in a different way. You can choose from one of the following scaling methods:

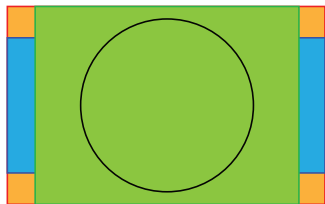
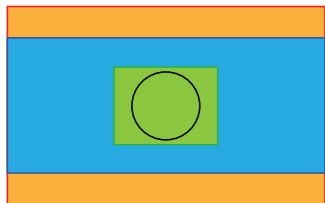
Scaling Mode	Explanation	Example image <sup>2</sup>
Fill aspect	<b>Default scaling mode.</b> Stretches the image to the native resolution of the DMD, while respecting the original aspect ratio.	
1:1	An exact rendering of the source signal, which may be smaller than the native resolution	

2. Example using a screen of 2,35:1, an input signal of 4:3 and a projector with a native resolution of 3840 x 2400

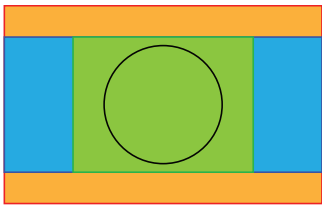
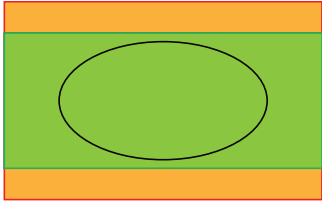
Scaling Mode	Explanation	Example image <sup>3</sup>
Fill screen	Fills the screen to the screen size defined in the Screen Size menu, while respecting the original aspect ratio. For more info on adjusting the Screen Size menu, see “Warping – Screen Size”, page 88.	
Stretch	This mode stretches the image to the screen size defined in the Screen Size menu, while ignoring the original aspect ratio. For more info on adjusting the Screen Size menu, see “Warping – Screen Size”, page 88.	

### Setting a scaling mode

1. In the main menu, select *Installation* → *Scaling*.

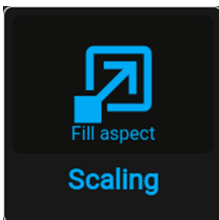

Image 8–23 Installation menu, scaling

The scaling mode menu is displayed.

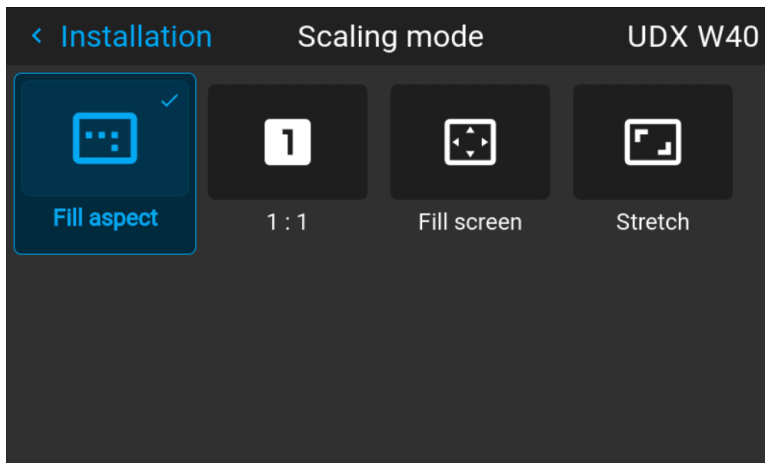

Image 8–24 Example of the scaling mode menu

2. In the Scaling menu, select the desired scaling mode and confirm.

## 8.11 Warping

### About warping

Image warping is the process of digitally manipulating an image to compensate for the distortion of the screen. Consequently, it can also be used to generate an image with irregular shape.

While an image can be transformed in various ways, pure warping doesn’t affect the colors.

3. Example using a screen of 2,35:1, an input signal of 4:3 and a projector with a native resolution of 3840 x 2400

## 8.11.1 Warping – On/Off

### About warping on/off

By toggling between on and off the warping functionality can be enabled or disabled.

### How to toggle

1. In the main menu, select *Installation* → *Warp*.



Image 8–25 Installation menu, warp

The Warp menu is displayed.

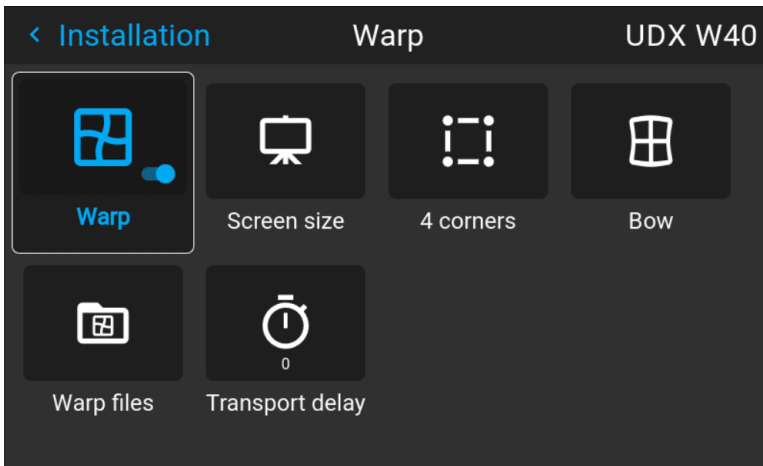

Image 8–26 Example of the Warp menu

2. In the Warp menu, click *Warp* to toggle between *On* and *Off*.

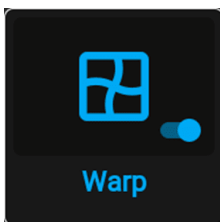

Image 8–27

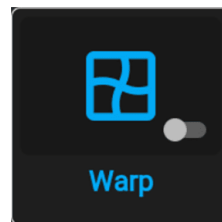

Image 8–28

## 8.11.2 Warping – Screen Size

### About (Warp) Screen Size adjustment

If the used source aspect ratio is different than the projector aspect ratio (e.g. source is 16:9 and projector is 16:10), then black bars will be projected. In this example case a black bar on top and bottom of the image will be projected. The warp area contains not only the image information but also the black bars.

If we want to position (e.g. the active left top corner exactly on the screen using 4 corner warp), then it is very hard to do that as we are moving the black left top corner and we do not have control over the exact position of image left top corner. By moving the outline of the warp screen size to the active image information, the corner points of the warp area are now exactly on the corner points of the active image information and makes warping much easier.





Image 8-29 Warp outline example

## Using the screen aspect ratio presets

1. In the main menu, select *Installation* → *Warp* → *Screen Size*.

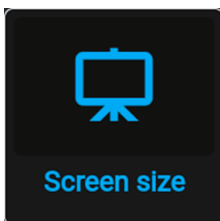

Image 8-30 Warp menu, screen size

The Screen Size menu is displayed.

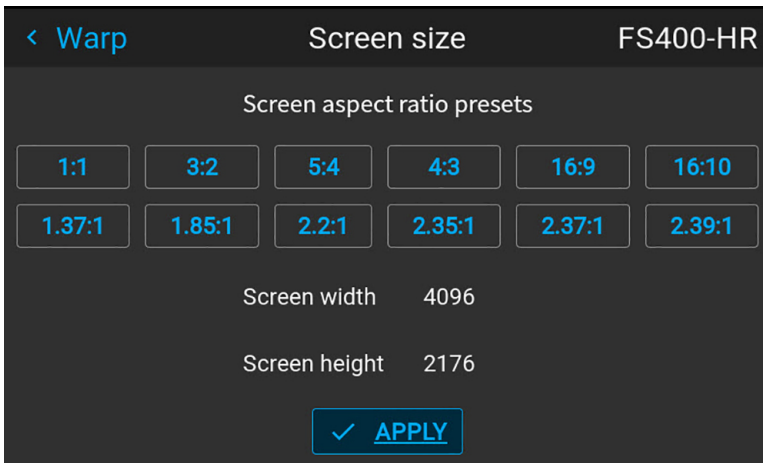

Image 8-31 Example of the screen size menu

2. Click on one of the predefined presets for the screen aspect ratio.

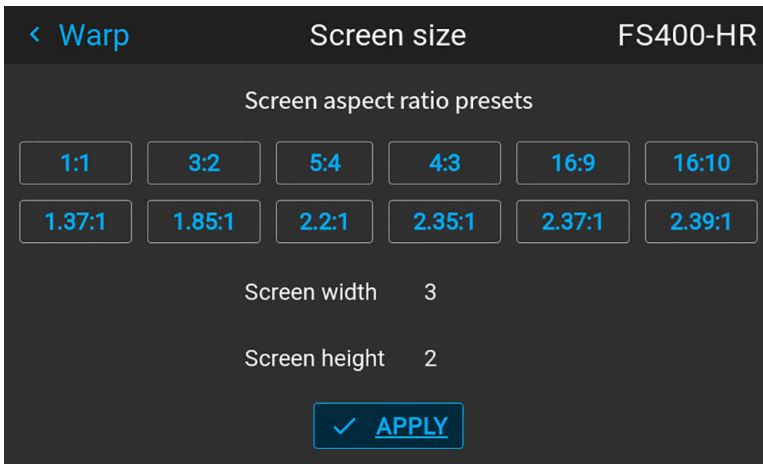

Image 8–32 Example of the screen size menu, with preset “3:2” selected.

The selected ratio is filled out next to *Screen width* and *Screen height*.

3. Click **Apply**.

### How to adjust the image with pixels?

1. In the main menu, select *Installation* → *Warp* → *Screen Size*.

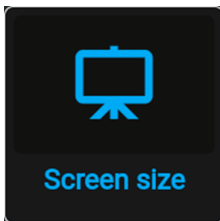

Image 8–33 Warp menu, screen size

The Screen Size menu is displayed.

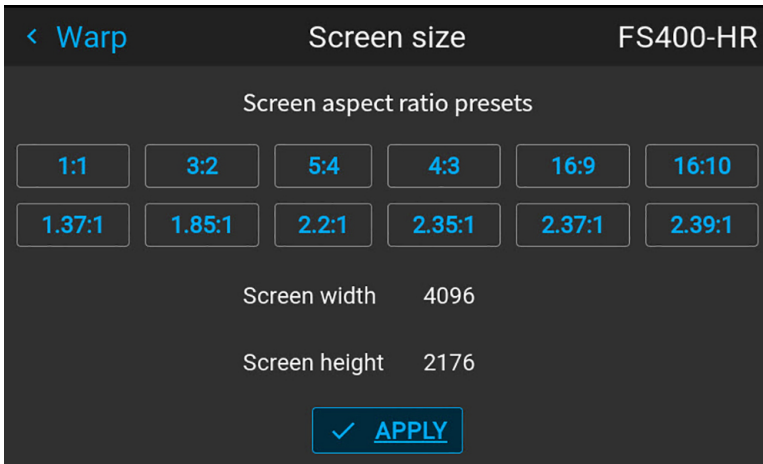

Image 8–34 Example of the screen size menu

2. Select either *Screen width* or *Screen height*.
3. Set the new value to shrink either the width or height of the warp outline so that the outline is equal with the active source.

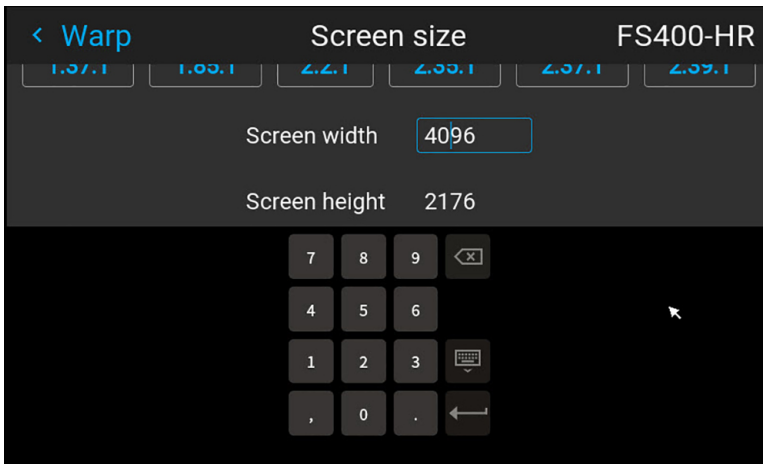



Image 8–35 Example of the Screen size menu, editing the screen width

-  *Tip:* A red border will be projected along with the current image. The border is a visual tool, showing the result of the adjusted outline.

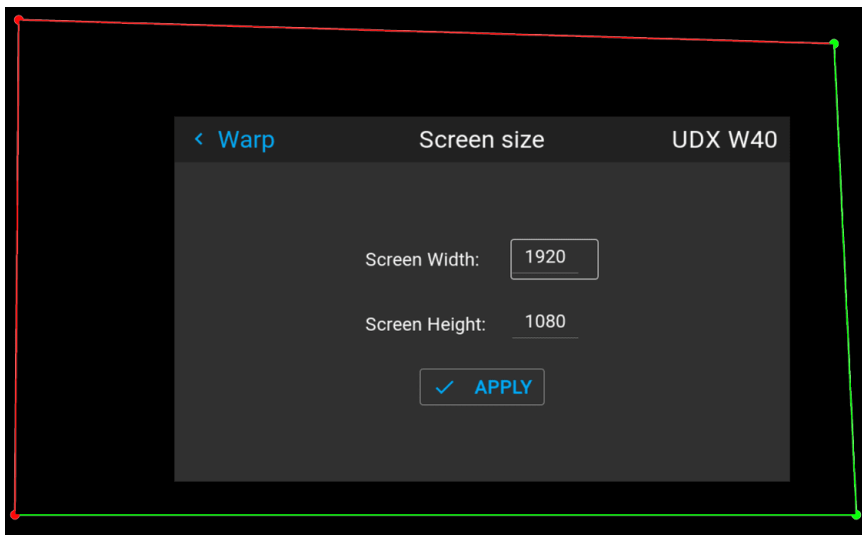



Image 8–36

-  *Tip:* The value can also be entered by the numeric keys on the remote control. Press \* to delete existing numbers, and enter the new value by the numeric keys.

4. Click **Apply**.

### 8.11.3 Warping – 4 corners adjustment

#### About 4 Corners adjustment

4 corner adjustment is typically used when the mechanical installation of the projector prevents it from pointing perpendicularly at the screen. For example, you can overshoot the screen and use 4 corner adjustment to pull your projected image corners back into the screen.

Some examples:



Image 8-37 4 corner adjustment

## How to adjust the image?

1. In the main menu, select *Installation* → *Warp* → *4 Corners*.

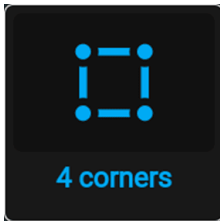

Image 8-38 Warp menu, 4 corners

The 4 corners menu is displayed.

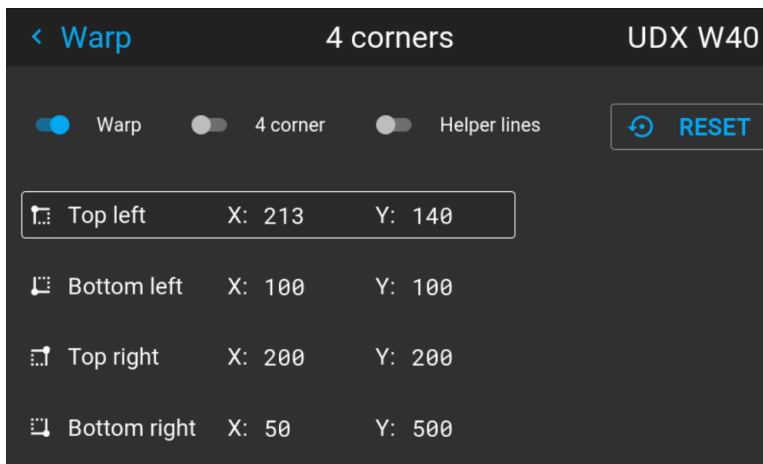

Image 8-39 Example of the 4 corners menu

2. To enable 4 Corners warping, enable the *4 corner* slider.
3. To have a visual representation of what your warp will look like, enable the *Helper lines* slider.

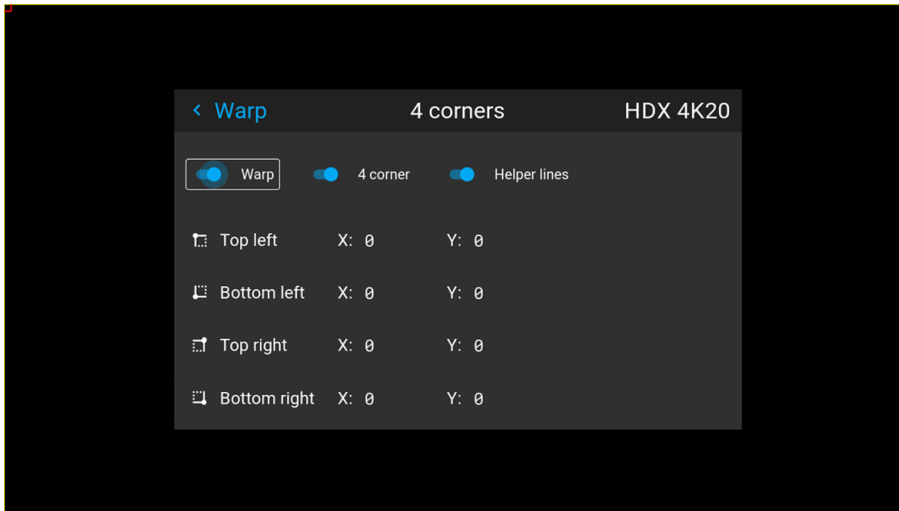

Image 8–40 Example of 4 corners warping menu, with helper lines active on the edges of the screen

4. To set warping on one of the four corners, select one of the four corners and confirm.
5. Set the desired X and Y coordinates for this corner, using the arrow keys, and confirm.

After confirming, the helper lines for that corner will jump to the entered XY coordinate (if helper lines were enabled).

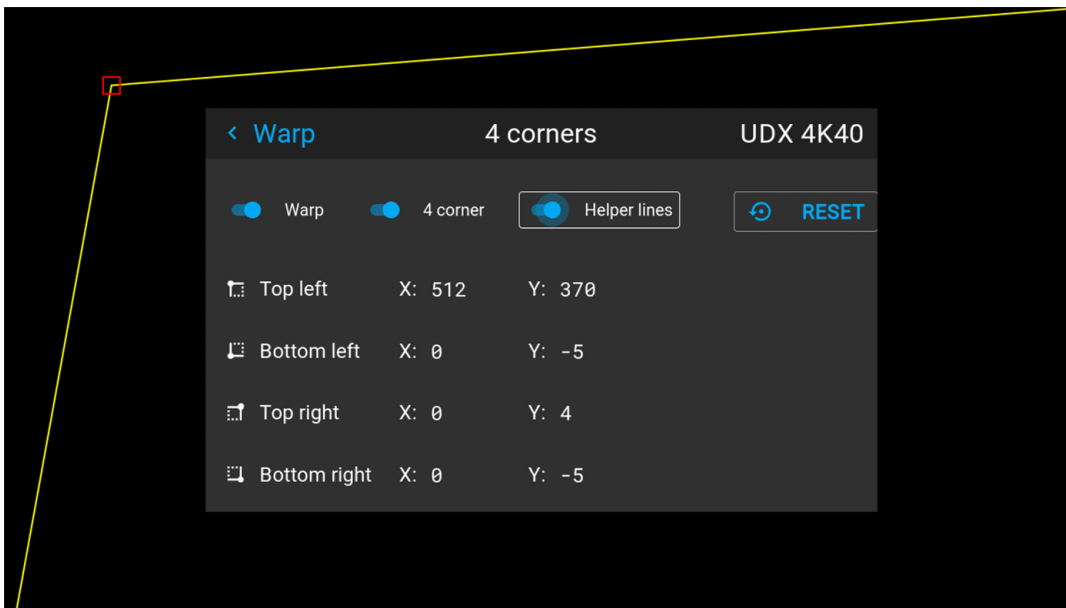

Image 8–41 Example of the 4 corners menu, with 4 corner warping and helper lines enabled

6. Repeat from go to step 4 for each corner, until all corners are warped in the desired position.



To reset the 4 corner adjustments, select *Reset* and press the **OK** button.

## 8.11.4 Warping – Bow

### About bow adjustment

A bow distortion can be adjusted so that a normal image is displayed. Positive adjustments introduce more outside bow distortion. Negative adjustments introduce more inside bow distortion.

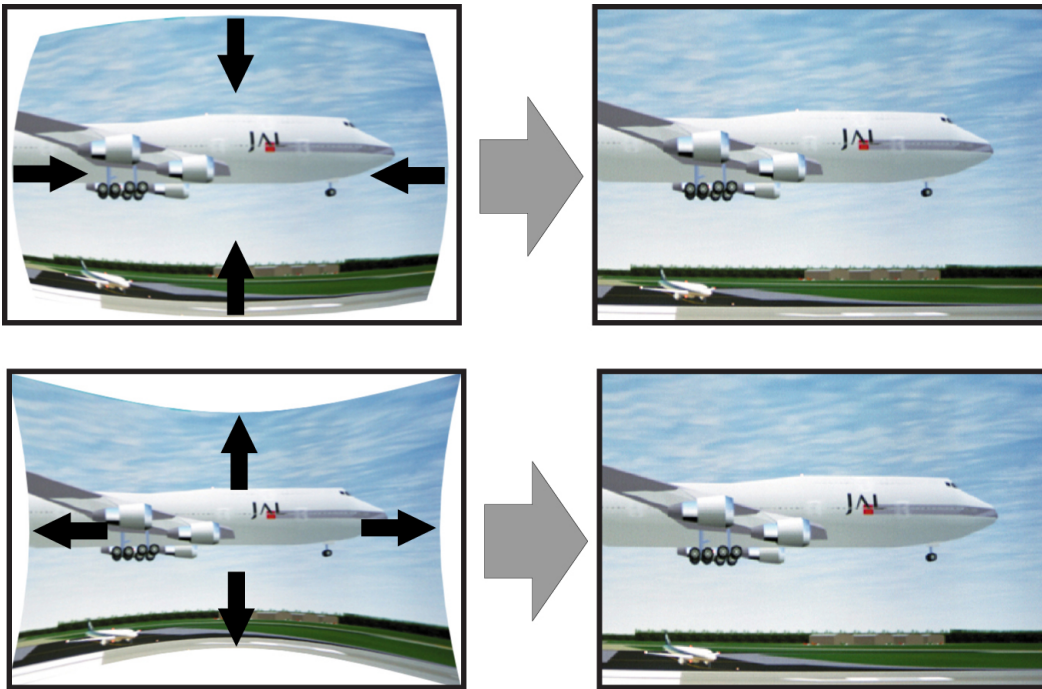

Image 8-42 Bow distortion

### Definition of angle and linearity (length) in the bow warp procedure

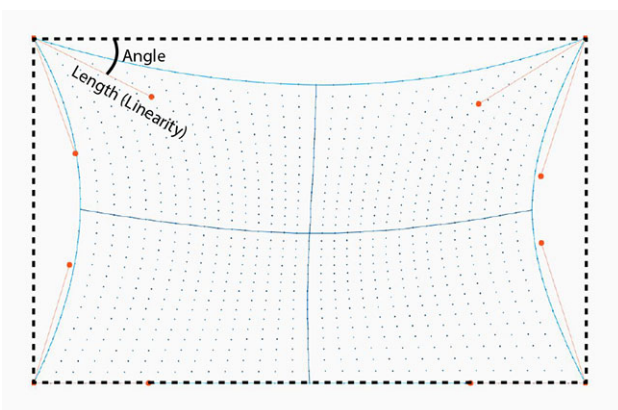

Image 8-43

### Symmetric bow correction

1. In the main menu, select *Installation* → *Warp* → *Bow*.

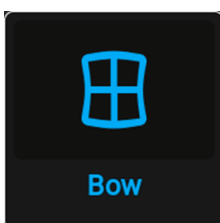

Image 8-44 Warp menu, Bow

The bow menu is displayed.

2. To enable bow correction, make sure the *Bow* slider is enabled (visible by the blue highlight).
3. To perform a symmetric adjustment, make sure the *Symmetric* slider is set to *On* (visible by the blue highlight).

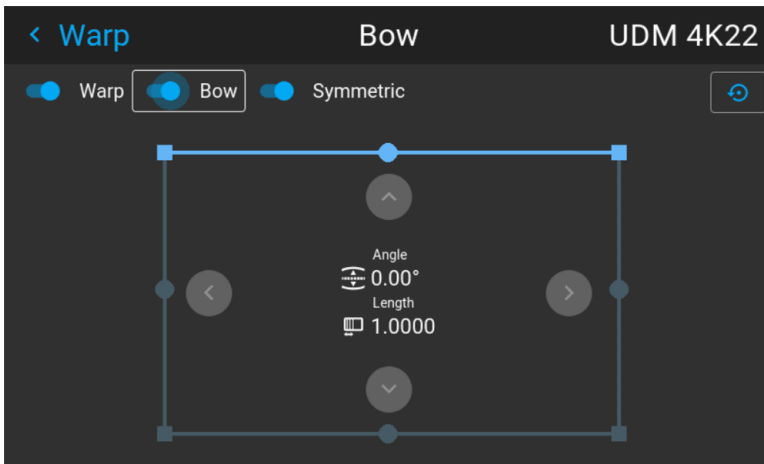

Image 8–45 Both the Bow and Symmetric sliders are set to on

4. Use the arrow keys to select the helping lines that represent the picture and confirm. The helping lines that represent the projected picture are now colored blue, while the others are colored white.

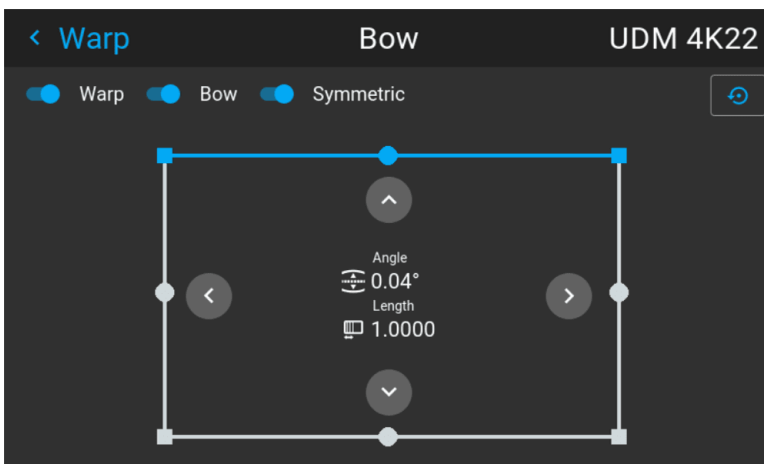

Image 8–46 The upper line is colored blue, the other sides are colored white

5. Use the arrow keys to select the side of the picture that needs a correction and confirm.

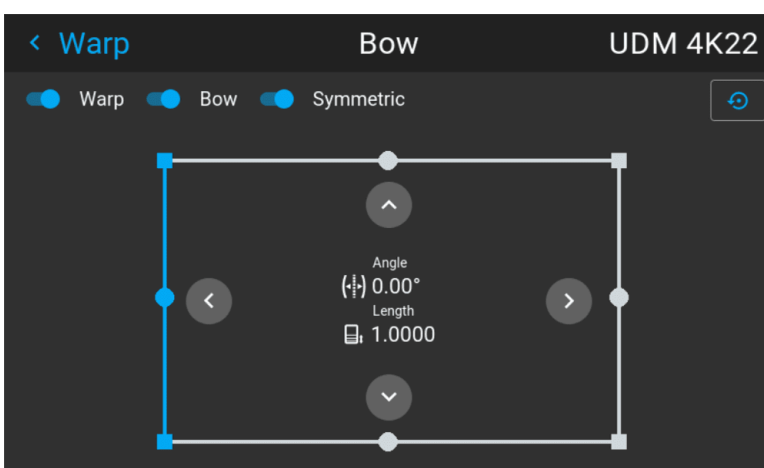



Image 8–47 Symmetric bow correction

6. Use the arrow keys to adjust the angle and linearity (length) of the vectors. Press enter to confirm and switch between angle and length.

 **Tip:** The angle is adjusted by using the up and down arrow keys. The linearity is adjusted by using the left and right arrow keys.

The correction will occur symmetrically on each side of the center of the highlighted side.

- Repeat this step for all sides of the picture that has to be corrected, until the desired transformation has been achieved.

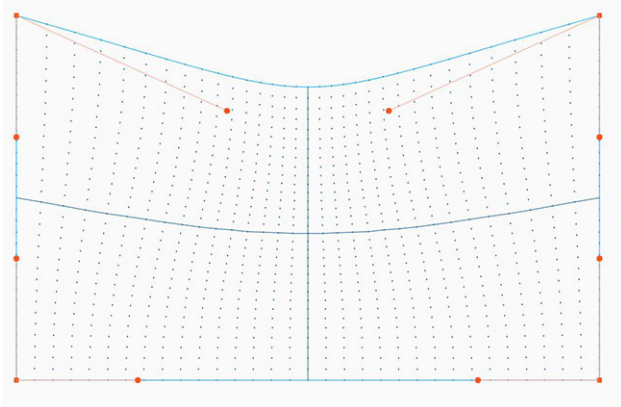

Image 8–48 Example of a symmetric bow correction

### Asymmetric bow correction

- In the Bow menu, enable the Bow slider and disable the symmetric slider.

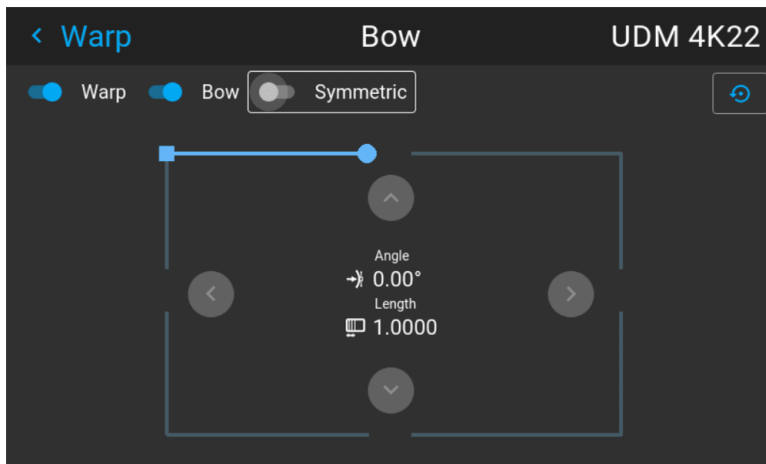

Image 8–49 Example of the bow menu, with the Symmetric slider disabled

There are now two vectors on each side of the picture that can be adjusted individually.

- Use the arrow keys to select the helping lines that represent the picture and confirm. The helping lines that represent the projected picture are now colored blue, while the others are colored white.

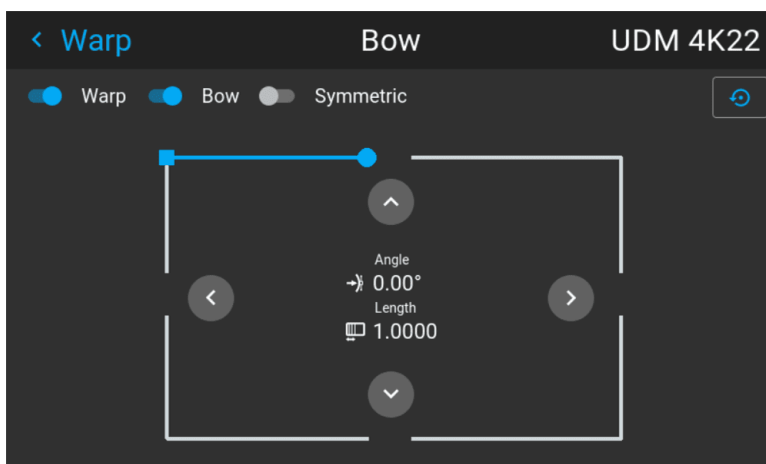

Image 8–50



3. Select the desired slider and confirm.

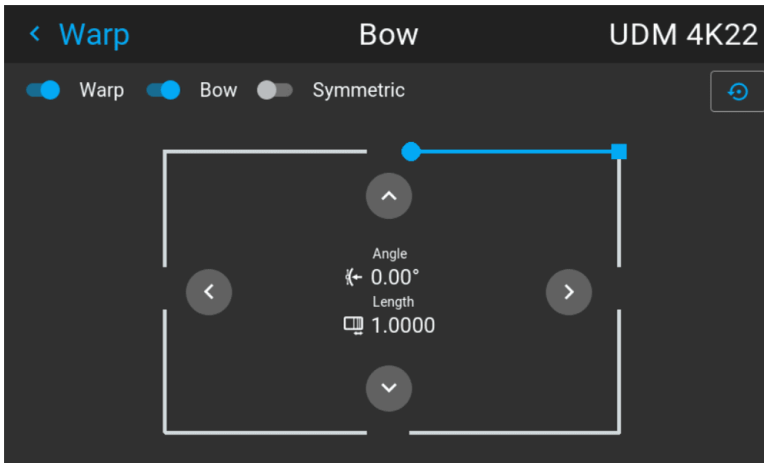

Image 8–51

4. Adjust angle and linearity (length) individually to obtain the correct correction. Press enter to confirm and to switch between angle and length.



*Tip:* Adjust the angle by using the up and down arrow keys. Adjust the linearity by using the left and right arrow keys.

5. Repeat the previous steps for each side of the picture that must be corrected.
6. When completed, a transformation will occur in a way similar to the following example. Observe that the upper side of the picture now has an asymmetric correction.

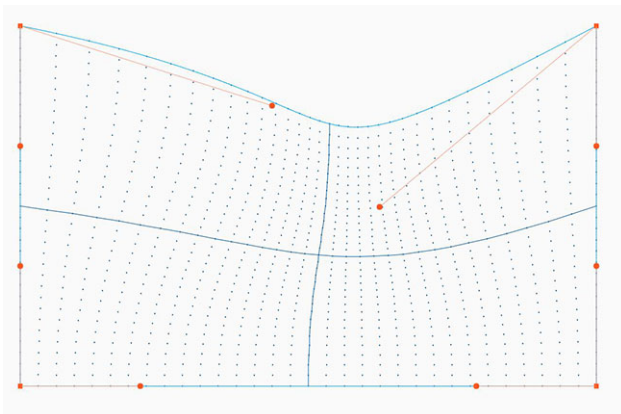

Image 8–52 Example of an asymmetric bow correction



To reset the bow adjustments, select *Reset* and confirm.

## 8.11.5 Warping – Warp files

### About custom Warp Files

Next to setting your specific warp configuration in the GUI, you can also upload or download a custom warp grid in XML format to/from the projector. This is a time-saving option when multiple projectors need an identical Warp configuration.

To upload or download warp files you can use Projector Toolset or Prospector tool to upload/download the warp grid in the format of an XML file. Alternatively, you can contact the “file endpoint” directly via the curl program or some other tool that supports http upload.

For more information on uploading/downloading Warp files using the Projector Toolset, refer to the Projector Toolset user manual.

For more information on uploading/downloading Warp files using curl or other tools that supports HTTP upload, refer to the Pulse API Reference Guide.



When uploading a warp file that is too big, or with warp parameters outside the limits of the projector, some irregularities can occur. It will show up in two ways:

- 1: No warp enabled, picture still unwarped.
- 2: Distortions and artifacts in the edges of the picture.

There will be no error messages or warnings in the display when this occurs. The above mentioned symptoms is the only indication of this case.

## How to activate an uploaded Warp grid?

1. In the main menu, select *Installation* → *Warp*.



Image 8–53 Installation menu, Warp

2. In the Warp menu, select *Warp files*.

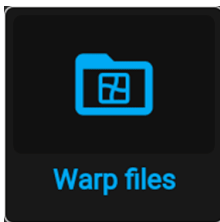

Image 8–54 Warp menu, Warp files

The Warp Files menu is displayed.

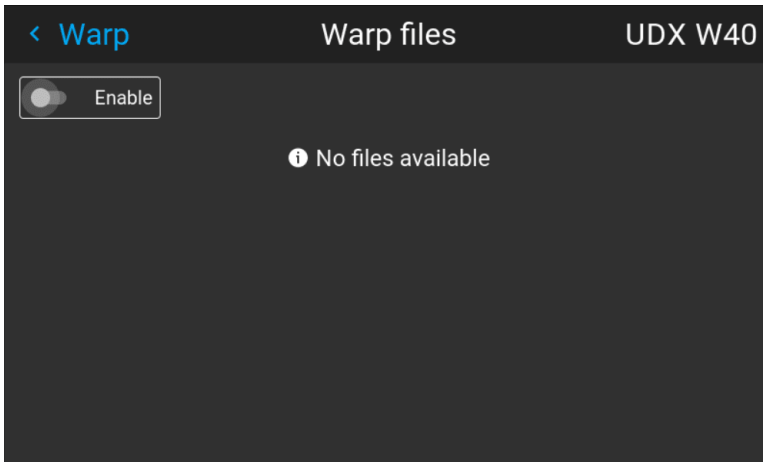

Image 8–55 Example of the Warp files menu

3. Make sure the Enable slider is set to right.
4. Select the desired warp file.

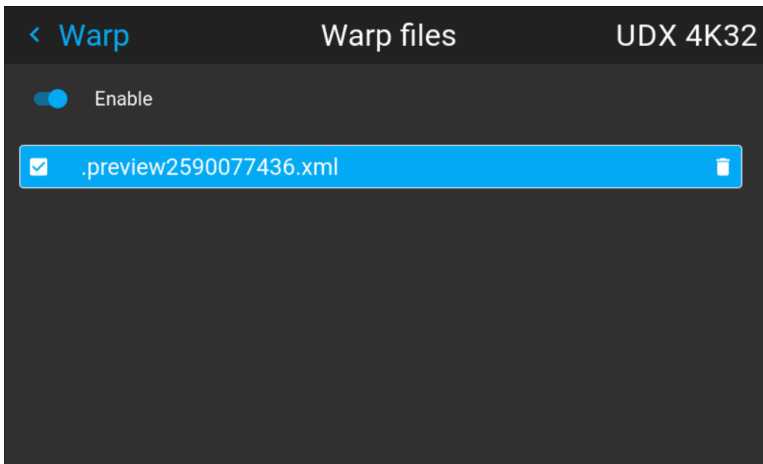

Image 8–56 Example of the Warp files menu

### 8.11.6 Warping – Latency control in a multi projector setup



**Transport latency**

The added delay in the image processing chain. The value is the number of lines relative to the output resolution.



**Latency**

The total time from the first pixel is coming in on an input source, until the first light representing that pixel is visible on the screen. This includes the transport delay. The value is normally given in milliseconds.

#### Functional description

Every projector in a multi-projector setup will have a different latency. This latency depends on the amount of warp and on the frequency of the projected image. In order to have no visible difference in the overall projected image, the user needs to be able to control the latency of each projector.

The latency value can be read out in the status menu for each individual projector.

#### How to configure transport delay?

1. Read out and note the latency of each projector in the multi-projector setup. You can find this latency under **Transport delay** in the status menu for each projector.

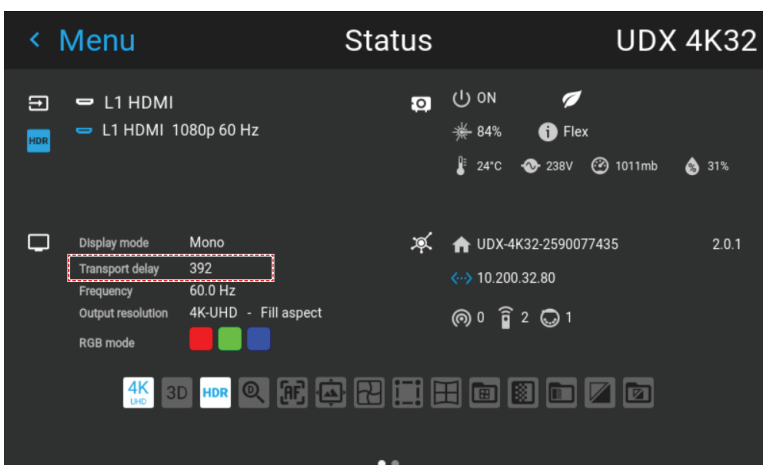

Image 8–57 Example of the Transport delay in the status menu

2. Identify the projector with the longest delay.
3. For each projector in the setup, select *Installation* → *Warp* in the main menu.



Image 8–58 Installation menu, Warp

4. In the Warp menu, select *Transport Delay*.

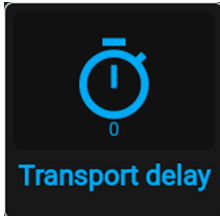

Image 8–59 Warp menu, Transport delay

The Transport menu is displayed.

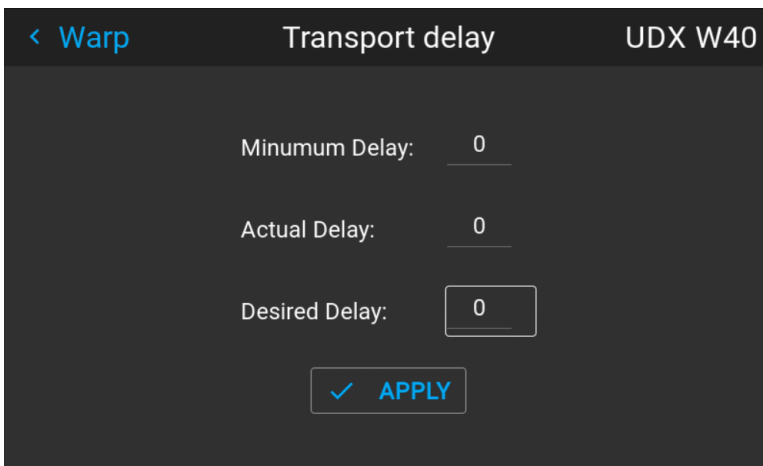

Image 8–60 Example of the Transport delay menu

5. Enter the value either by the arrow keys (one step at a time) or directly by the numeric keys on the remote control.
6. Click “Apply” to confirm the value.
7. Repeat this process for every projector in the setup.

## 8.12 Blending & masking

### About blending

Blending is used in multi channel installation to have a seamless transition between the channels. Image blending gives the appearance of a single view, thus achieving realistic immersion for the majority of wide screen applications.

The principle is that the light intensity in the blend zone from each projector will be adjusted individually, so that the rendering on the screen are perceived as from one projector.

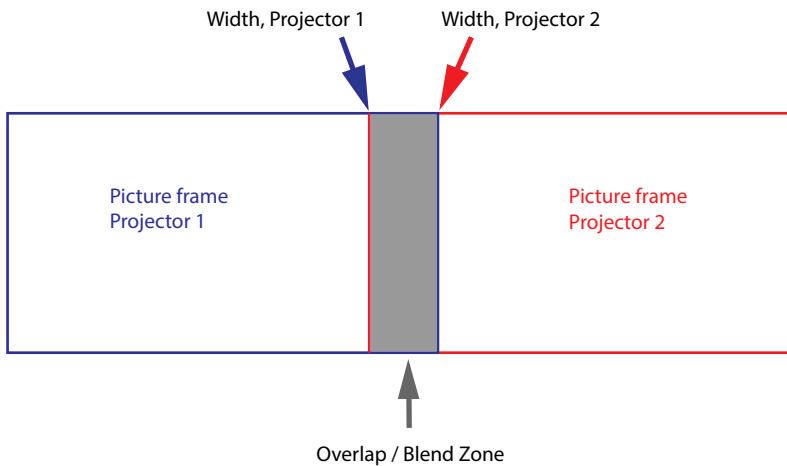

Image 8–61

From the start (mask) position, you can blend zone size per edge (left, top, right, bottom). For each edge there will be a drop-off curve for the blend zone.

### Waiting period and blend maintenance period

The heating and cooling down of the lens in a projector startup and shutdown cycle can have a minor drifting effect on the blending and masking areas. Due to this, it is advised to wait 15–20 minutes after projector startup before performing blending and masking actions. This to make sure the drift on the blend region is as minimal as possible. For a similar reason, it is advised to wait 15–20 minutes after projector startup before starting any blending maintenance in your existing setup.



It is recommended to perform a blend maintenance after every 10–20 startup-shutdown cycles of the projector.

## 8.12.1 Basic blend

### How to set up a basic blend zone?

1. In the main menu, select *Installation* → *Blend and Mask* → *Basic blend*.

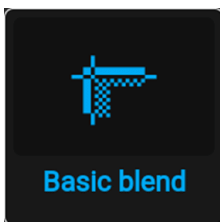

Image 8–62 Blend menu, Basic blend

The Basic blend menu is displayed.

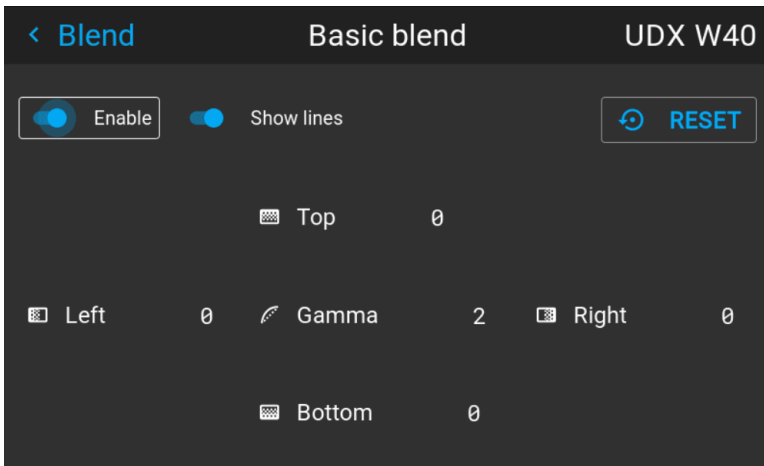

Image 8–63 Example of the basic blend menu

2. To enable blending, put the **Enable** switch to the right. The color of the switch becomes blue when enabled.
3. To project masking lines on the screen, put the **Show lines** switch to the right. The color of the switch becomes blue when enabled.
4. Determine the start position of the blend area height and width to determine the dimension of the blend zone.

When the helping lines are activated, you will get a visual indication of the screen of the installed blending area.

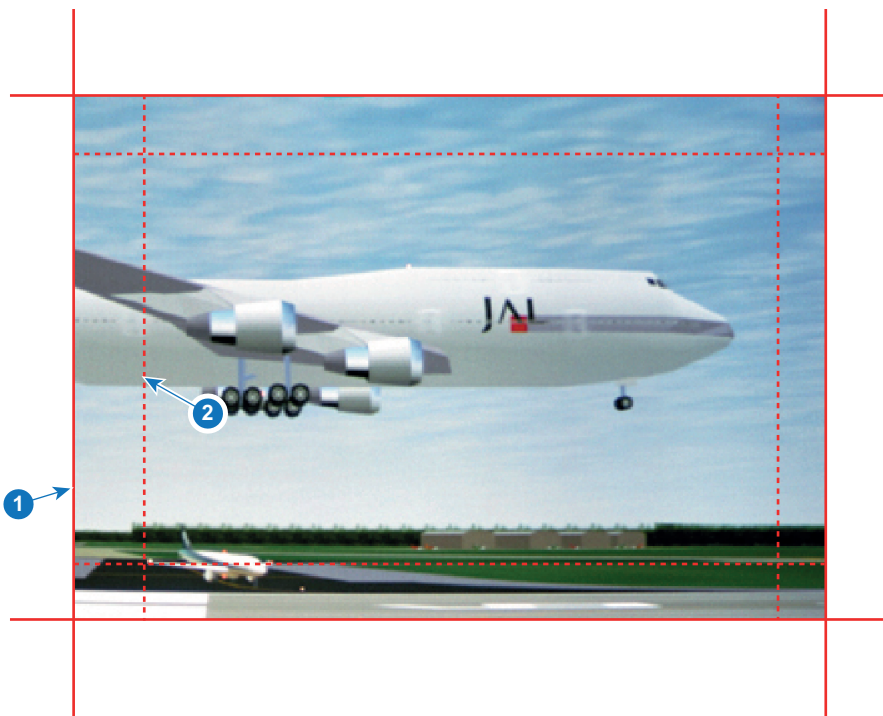

Image 8–64

- 1 Start position (mask)
- 2 Blending width

5. Select one of the four starting positions values with the arrow keys and confirm.
6. Use the arrow keys or remote digits to change the value of the blend zone and confirm.
7. Repeat this process for all other desired sides.
8. Continue by creating the blend mask. For more info, see [“Blend & Blend mask”, page 103](#).



Do not forget to disable the **Show lines** button after you achieved the desired blend zone.

## 8.12.2 Blend & Blend mask

### About masking and blending width or height

Offset is used to clip the image on one or multiple sides (masking). This is used to hide parts of the picture that should not be shown on the screen. For example: if the source is a Windows PC, you can hide the menu bar using this method.

The larger the Mask value, the more the image is masked (by black bar) at the corresponding side. E.g. Top mask of 100 will blank the top 100 lines.

Height or width is used to create a blending zone with a smooth brightness drop off. This is used to compensate for the double brightness in overlap areas. The value is the size of the blended area in pixels.

### How to set up basic blend zones?

1. In the main menu, select *Installation* → *Blend and Mask* → *Blend mask*.

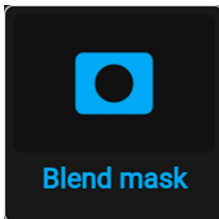

Image 8–65 Blend menu, Blend mask

The Blend mask menu is displayed.

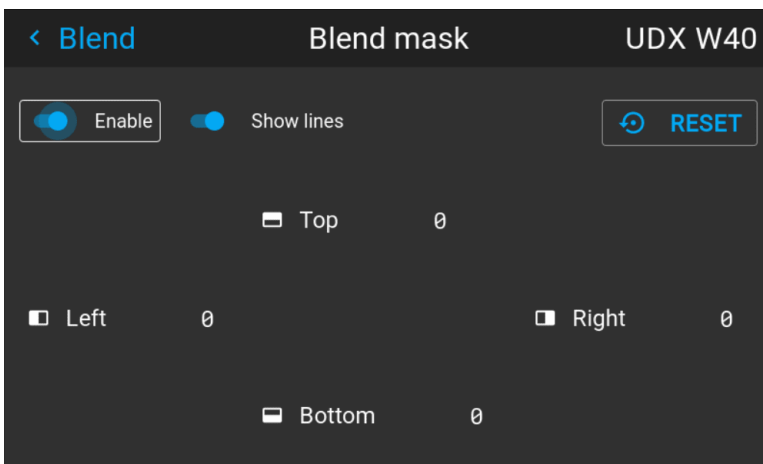

Image 8–66 Example of the blend mask menu

2. To enable the blend mask, put the **Enable** slider to the right. The color of the slider becomes blue when enabled.
3. To project masking lines on the screen, put the **Show lines** slider to the right. The color of the slider becomes blue when enabled.
4. Determine the start position of the mask (1) for the masking height and width, together with the desired size of the mask (2) to determine the width of the masked area.

When the helping lines are activated, you will get a visual indication of the screen of the installed blending area.

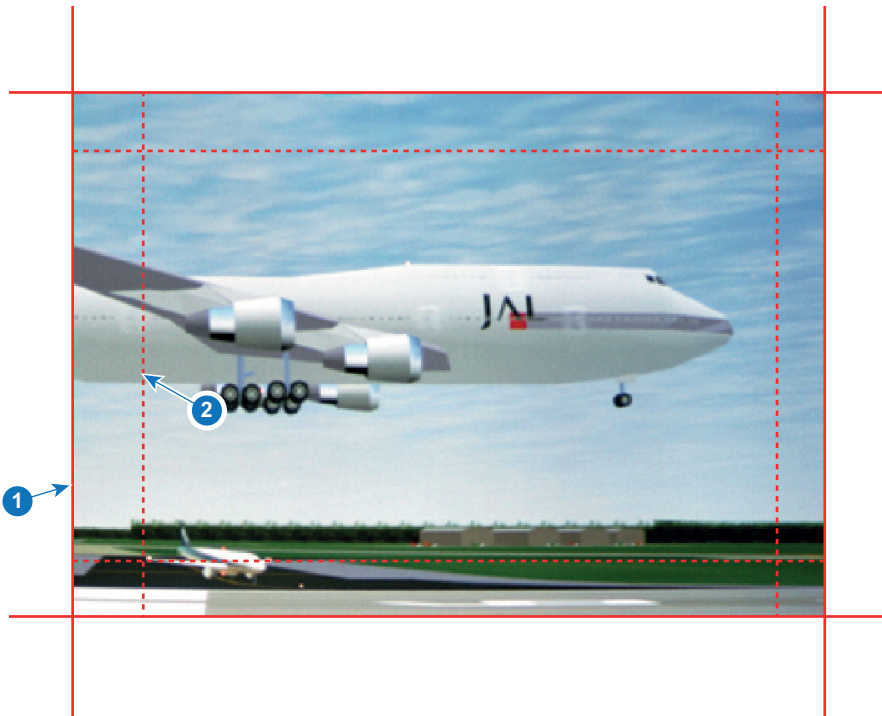

Image 8-67

- 1 Start position (mask)
- 2 Blending width

5. Select one of the four starting positions values with the arrow keys and confirm.
6. Use the arrow keys or remote digits to change the value of the mask and confirm.
7. Repeat this process for all other desired sides.



Do not forget to disable the **Show lines** button after you achieved the desired blend zone.

### Example of the use of blending

When projecting an image with 2 or more projectors, there is always an small overlap that should be corrected by using the blending function.



In order to obtain a satisfying result for the Blend function, the overlap / mask zone are recommended to be at least 10% of the picture width.

The basic principle is that the overlap setup in the source shall correspond with the mask width setup for the projector. That means that if the overlap zone for the source is set to 500 pixels, the width of the mask zone for the projector also must be set to 500 pixels.

First step is to align the image from the projectors as accurate as possible in a mechanical way, meaning without any optical corrections. At the same time, establish an overlap in the pictures between the two screens.

Then adjust the remaining irregularities by using the shift and warp features in the projectors to obtain the last fine tuning of the alignment.

Enable blending and activate Show lines.

First set the mask width for the right edge of the first projector. Enter a width value equal to the overlap area (width1).

Repeat for the left edge of the second projector.

Adjust the offset to cut the image on each side (masking).



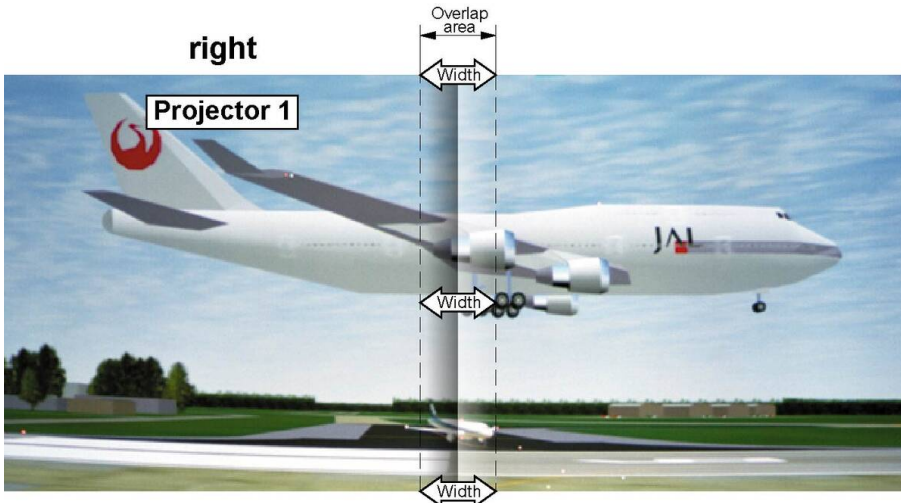

Image 8-68 Set up for projector 1

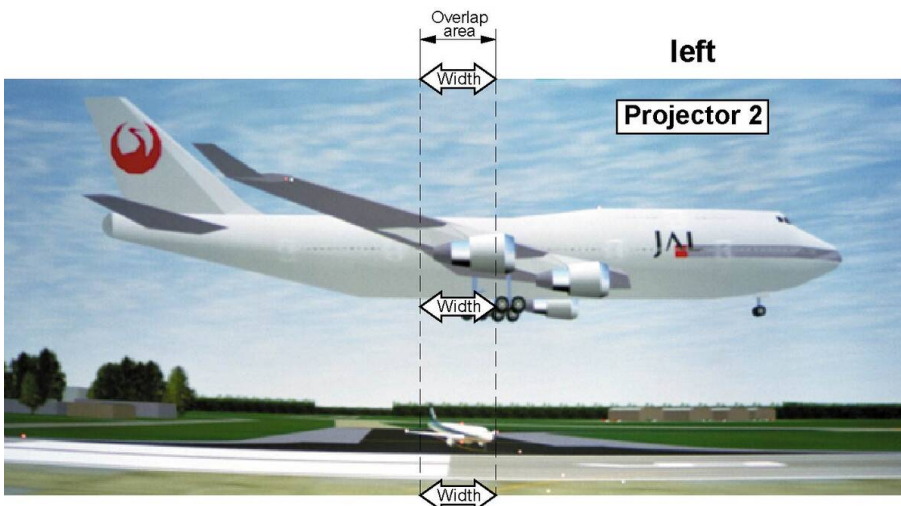

Image 8-69 Set up for projector 2

### 8.12.3 Blend Files

#### About custom Blend Files

Next to setting your specific Blending configuration in the GUI, you can also upload or download a custom Blend configuration file in png, jpg or tiff format to/from the projector. This is a timesaving option when multiple projectors need an identical blending configuration.

To upload or download Blend configuration files you can use Projector Toolset or upload/download the Blend configuration file in the format of an xml file. Alternatively, you can contact the “file endpoint” directly via the curl program or some other tool that supports http upload.

For more information on uploading/downloading blend files using the Projector Toolset, refer to the Projector Toolset user manual. For more information on uploading/downloading blend files using curl or other tools that supports HTTP upload, refer to the Pulse API reference guide.



When uploading custom blend files onto multiple projectors, make sure that the resolution of the blend file is supported by the projector you are uploading it to. A mismatch of projector resolution and blend mask resolution will result in a sub-optimal image performance. Verify the supported resolutions for the specific projector model via the Introspection tool [Introspection – image – resolution – alpha]. For more info on the introspection tool, consult the Pulse API reference guide.

#### How to activate an uploaded Blend configuration file?

1. In the main menu, select *Installation* → *Blend and Mask* → *Blend Files*.

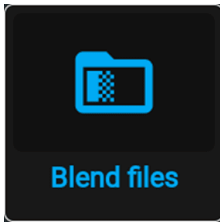

Image 8–70 Blend and mask menu, Blend files

The Blend Files menu is displayed.

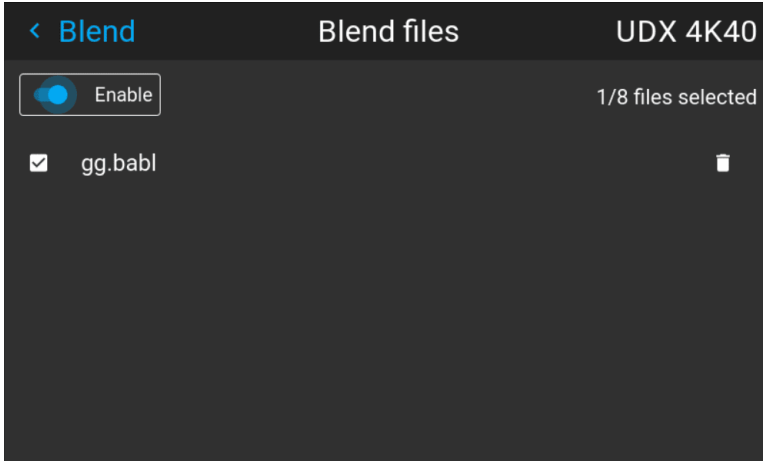

Image 8–71 Example of the blend files menu

2. If any custom Blend files are available, select the desired file.

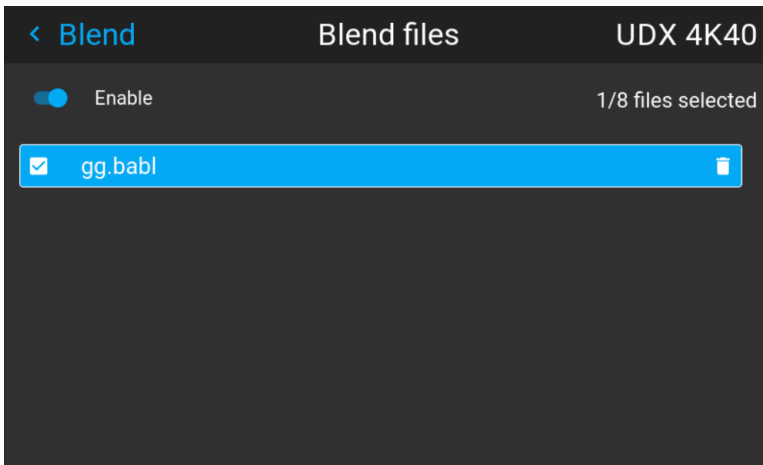

Image 8–72

3. To enable the selected blend file, make sure the **Enable** slider is set to the right. The color of the slider becomes blue when enabled.

## 8.12.4 Basic black level adjustment

### About adjusting the black level

The purpose of the black level adjustment is to align the black levels in the overlapped regions with the black levels in the other regions.

This is needed because the black levels will be brighter in the blend zones, since multiple projectors will project on the same screen area.

The size of the black level area is calculated automatically from the blend zones. This is done by using the start position and size of each edge of the blend and adding an additional size of 8 pixels to reduce the effect known as "sea of mirrors".

You can also specify the offsets manually by turning off the automatic calculation. The black level value is adjusted in a 16-bit resolution from 0 to 65535.

The following figure shows how this occurs in a side by side configuration without any correction of the black level.



Image 8-73

### How to adjust the black level manually

1. In the main menu, select *Installation* → *Blend and Mask* → *Black Level*.

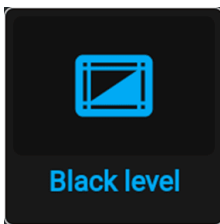

Image 8-74 Blend and Mask menu, Black level

The Basic black level menu is displayed.

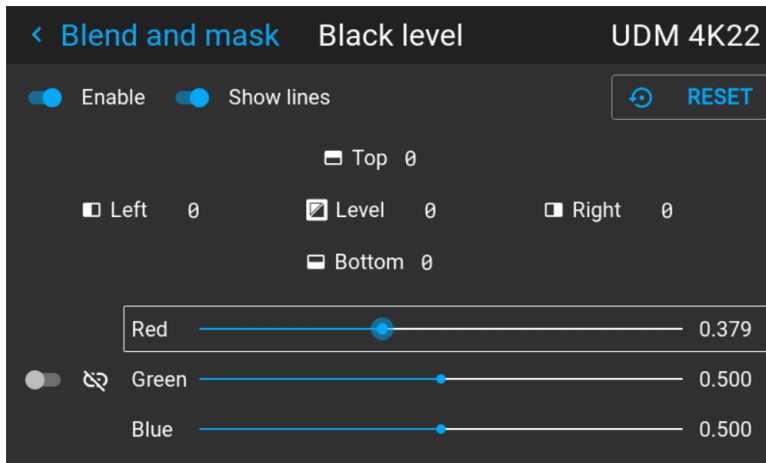

Image 8-75 Example of the default black level menu

2. Enable the **Black level** slider. If you want a visual aid, enable the **Show lines** slider as well.
3. Move the cursor to the side where the overlapped area occurs (*Top*, *Left*, *Right* or *Bottom*) and press enter.
4. Adjust the level with the arrow keys and press enter when the desired black level zone is reached.  
or  
enter the black level value with the numeric keys in the remote control.
5. Move the cursor to *Level*, press enter and adjust this level until the black level equals the level in the blend zone.

This value can also be entered by the numeric keys on the remote control.

- Repeat the same procedure for any other projector connected to this projector, but on the opposite side.

 **Note:** Do not forget to disable the **Show lines** button after you achieved the desired blend zone.

## 8.12.5 RGB gain adjustment

### About RGB gain adjustment

The purpose of black level correction is to ensure a uniform black level in multi projector setups. Even when two projectors are of the same type, different projectors will output slightly different colors for black due to minor variations in their optical components. So if the projected image of the projectors overlap, there will be 3 different black levels: one for the zone where only the picture of the left projector (zone 1), one for the Blend zone (zone 2), and one for the zone where there is only the picture of the right projector (zone 3).



Image 8–76

The black levels for zone 1 and zone 3 are typically corrected by defining a black level mask, which is applied to the image of each projector. This system is already in place but the applied mask is monochrome.

Using the Basic Black Level menu, you can already specify the area of the mask and its contents. But by using the RGB Adjustment page, you can specify the multiplication factors (gains) for the Red, Green and Blue colors separately.

### How to perform an RGB adjustment

- In the main menu, select *Installation* → *Blend and Mask* → *Black Level*.

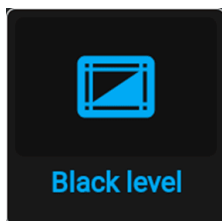

Image 8–77 Blend and Mask menu, Black level

The Basic black level menu is displayed.

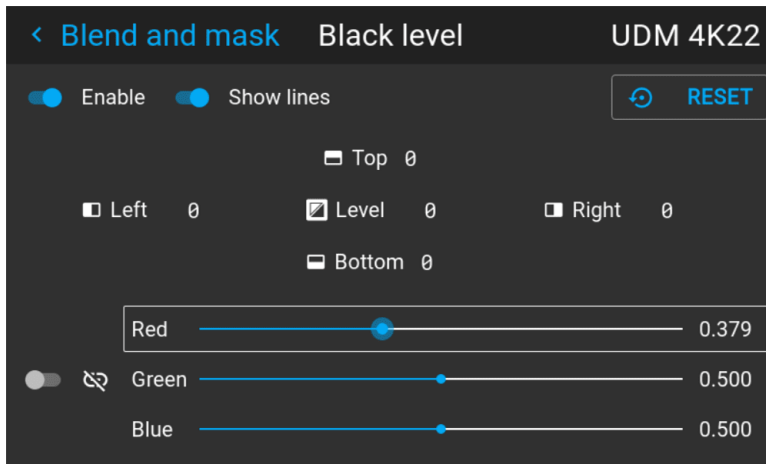

Image 8–78 Example of the default black level menu

2. Select one of the three sliders on the bottom of the menu (Red, Green or Blue).
3. Use the left and right arrow keys to modify the gain of the chosen color.
4. Repeat for every slider until the desired result is achieved on screen.

## 8.12.6 Black Level Files

### About custom Black Level Files

Next to setting your specific Black Level Adjustment in the GUI, you can also upload or download a custom Black Level adjustment file in png, jpeg or tiff format to/from the projector.

To upload or download Black Level adjustment files you can use Projector Toolset or upload/download the Black Level adjustment file in the format of an XML file. Alternatively, you can contact the “file endpoint” directly via the curl program or some other tool that supports http upload.

For more information on uploading/downloading Black Level files using the Projector Toolset, refer to the Projector Toolset user manual. For more information on uploading/downloading Black Level files using curl or other tools that supports HTTP upload, refer to the Pulse API Reference Guide.



When uploading custom black level files onto multiple projectors, make sure that the resolution of the file is supported by the projector you are uploading it to. A mismatch of projector resolution and black level file resolution will result in a sub-optimal image performance. Verify the supported resolutions for the specific projector model via the Introspection tool [Introspection – image – resolution – alpha]. For more info on the introspection tool, consult the Pulse API reference guide.

### How to activate an uploaded Black Level adjustment file?

1. In the main menu, select *Installation* → *Blend and Mask* → *Black Level* → *Black Level Files*.

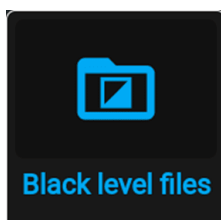

Image 8–79 Blend and mask menu, Black level files

The Black Level Files menu is displayed.

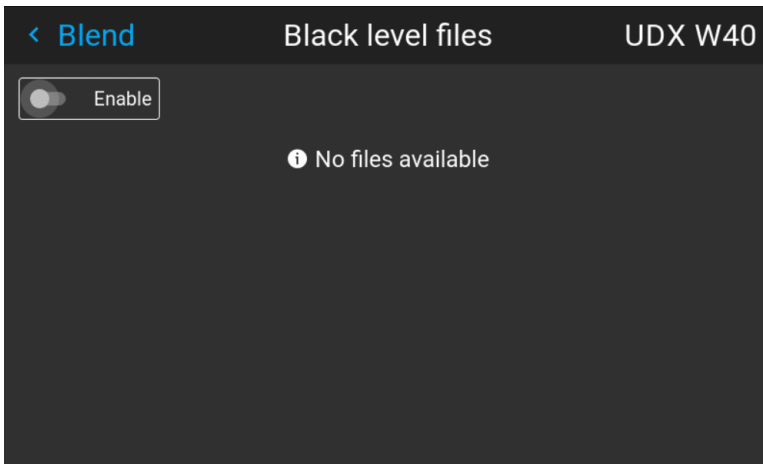

Image 8–80 Example of the black level files menu

2. If any custom Black Level adjustment files are available, select the desired file.

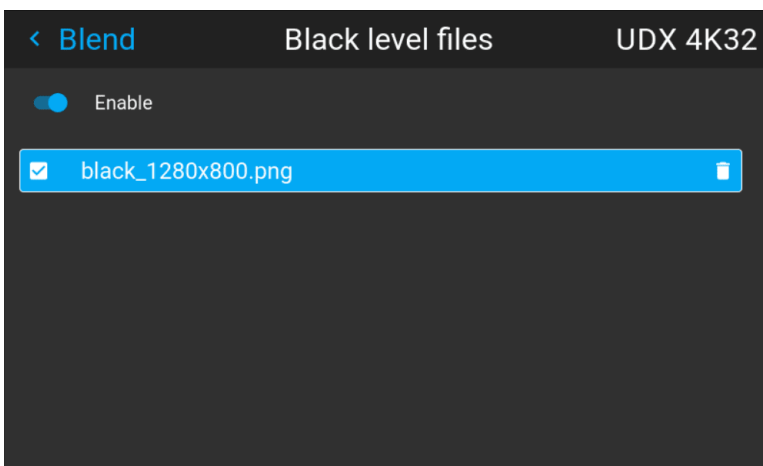

Image 8–81 Example of custom black level files selected

3. Make sure the Enable slider is set to the right to activate the selected black level file

## 8.13 Illumination

### What can be done?

Within a certain percentage, the light output of the light source can be reduced by reducing the power slider.

Alternatively, you can enable CLO mode (Constant light output) for a constant light output over a longer period of time.



You can only change the power output when the shutter is opened.

### About CLO mode

All light sources naturally decrease their intensity over time. In order to prevent a decreasing output in a multi-projector setup, you can activate CLO mode to make sure that the light output remains constant.

CLO mode will ensure that the projector regulates its illumination power to maintain the same level of output light during the lifetime of the light source. This requires that the light source power is not set to 100% from the start, but to a lower value. The lower this value is set, the longer the projector will be able to maintain the output level.



CLO can not be used when the light source is off, the shutter is closed or if the Dynamic Black feature is active (if available).

## How to reduce the power

1. In the main menu, select *Installation* → *Illumination*.



Image 8–82 Installation menu, illumination

The Illumination menu is displayed.

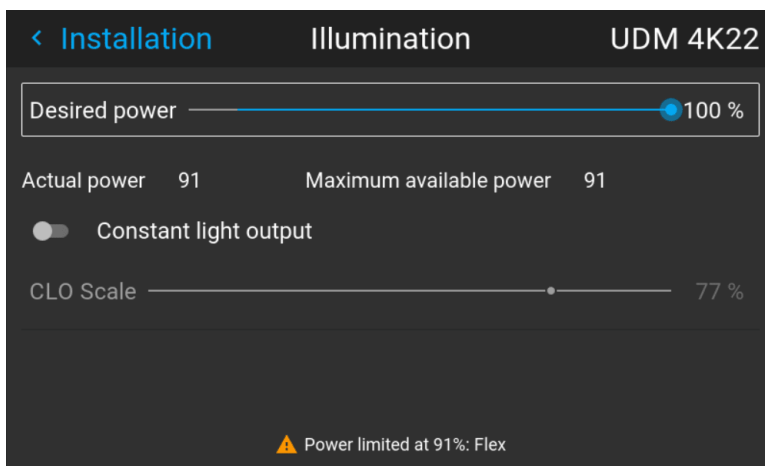

Image 8–83 Example of the Illumination menu

2. Use the Slider to change the power value.
3. Enable the *Constant light output* slider if you want to enable CLO mode.
4. If CLO mode is active, you can use the CLO Scale slider to scale the light output.

## 8.14 3D projection

### 3D setup

The projector is capable of displaying 3D images and movies in active stereoscopic 3D.

Setup of a 3D installation requires an advanced understanding of 3D systems, both for the projector as well as for the system the signal source originates from. In a 3D setup it is crucial that the projected images are perfectly synchronized through the whole signal path, from the signal source to the picture viewed through the 3D goggles.

Regarding setting up the proper signal source, please refer to the user manual or online help for that graphic card. For example: when using NVIDIA Quadro cards, use the NVIDIA Control Panel to manage your 3D settings.

### 8.14.1 Active Stereo & Passive Stereo

#### What is Passive Stereo?

Passive Stereoscopic 3D (also known as “Passive Stereo”) is the standard method of creating the illusion of depth in an image, by means of stereopsis for binocular vision.

To present stereoscopic pictures, two images are projected superimposed onto the same screen through polarizing filters or presented on a display with polarized filters. For Digital Cinema, a silver screen is used so that polarization is preserved. On most passive displays every other row of pixels are polarized for one eye or the other. This method is also known as interlacing.

The viewer wears glasses which contain a pair of opposite polarizing filters. As each filter only passes light which is similarly polarized and blocks the opposite polarized light, each eye only sees one of the images, and the effect is achieved.

## What is Active Stereo?

Field sequential 3D (also known as active 3D or “Active Stereo”) is a technique of displaying stereoscopic 3D images. It works by only presenting the image intended for the left eye while blocking the right eye's view, then presenting the right-eye image while blocking the left eye, and repeating this so rapidly that the interruptions do not interfere with the perceived fusion of the two images into a single 3D image.

This system setup uses liquid crystal shutter glasses (also known as active shutter glasses). Each eye's glass contains a liquid crystal layer which has the property of becoming opaque when voltage is applied, being otherwise transparent. The glasses are controlled by a timing signal that allows the glasses to alternately block one eye, and then the other, in synchronization with the refresh rate of the screen. The timing synchronization to the video equipment may be achieved via a wired signal or via wireless communication, this by using either an infrared or radio frequency (e.g. Bluetooth, DLP link) transmitter.

## Projection method used

This projector can only show active 3D images, used in combination with a 3D emitter and active shutter glasses. While it is allowed to connect passive stereo source signals, the image processing of the projector will convert those signals to an active 3D compatible image.

The options on the projector software allow you to fine-tune the 3D settings accordingly to the specifications of the 3D emitter.



If a 3D emitter is used that radiates IR beams, the IR beams may interfere with the IR communication between projector and the RCU. If such interference occurs, connect the RCU to the projector using the remote cable. It is also advised to turn the IR receivers on the projector off to avoid the 3D emitter interference. To turn off the IR receivers, see [“Pulse RCU, function of the on/off button”, page 31](#).

## 8.14.2 Setup process 3D projection

### How to setup 3D projection?

1. Connect the proper source cables to the projector. For more info, see [“Connection possibilities”, page 112](#).
2. Set up and connect your 3D emitter to the projector. For more info, refer to the user manual of your 3D emitter.
3. Power on the projector completely.
4. Select the correct stitched source Input in the Source menu. See [“Displaying multiple sources: Stitched layouts”, page 56](#).
5. Depending on the chosen 3D emitter and chosen source, correct the 3D setup. For more info, see [“3D Setup”, page 113](#).

## 8.14.3 Connection possibilities



At this moment, the only inputs supporting 3D on the Pulse input boards are the DisplayPort inputs and HDMI input. More inputs may support 3D in a future release.

### Connecting with the quad combo input card

There is only one way of projecting Active stereoscopic 3D with the Combo input card, using the following setup:

- **Source:** Active Stereo (sequential L/R)



- **Layout mode:** Standard layout (1x1 layout)
- **Video Timing:** 2560 x 1600 (WQXGA) @120 Hz
- **Color depth:** 30 bpp
- **Connector:** DisplayPort 1.2 or HDMI

### Connecting with the quad DP 1.2 Input card

You can use one of the following methods. The resulting image will always be an Active Stereo image.

Source	Layout mode	Video Timing / cable	Fixed configuration?	Color depth
Active Stereo (sequential L/R)	Standard layout (1x1 layout)	2560 x 1600 @120 Hz		30 bpp
Active Stereo (sequential L/R)	4 Column mode (4x1 layout)	960 x 2160 @120 Hz		30 bpp
Active Stereo (sequential L/R)	4 Quadrant mode (2x2 layout)	1920 x 1080 @120 Hz		30 bpp
Passive Stereo (separate L/R)	Standard layout (1x1 layout)	3840 x 2160 @60 Hz	<ul style="list-style-type: none"> <li>• Cable 1: left eye</li> <li>• Cable 2: right eye</li> </ul>	30 bpp
Passive Stereo (dual pipe L/R)	2 Column mode (2x1 layout)	1920 x 2160 @60 Hz	<ul style="list-style-type: none"> <li>• Cable 1: left eye, left column</li> <li>• Cable 2: left eye, right column</li> <li>• Cable 3: right eye, left column</li> <li>• Cable 4: right eye, right column</li> </ul>	30 bpp

## 8.14.4 3D Setup

### Why change the 3D setup?

While Barco can provide a 3D emitter and active shutter glasses as options to this projector, you are also free to use a 3D emitter and active shutter glasses of your own choice. Since glasses and emitter can have various specifications compared to the ones Barco can provide, the 3D setup menu allows you to configure the output image to the specifications of your glasses and emitter. The following can be configured:

- **Swap Eyes:** You can choose to invert the stereo Sync output signal ( depending on the chosen 3D emitter and glasses).
- **Swap frame pair:** This setting allows you to correct the frame doubling sequence. If the frame rate of the projected moving 3D content doesn't look smooth, this option may help improve this.
- **Dark time:** You can select how much dark time the projected image will have between frames. You can choose one of the options between 1000 µs and 2500 µs.
- **Output mode:** Choose the desired output mode. For more details, see further.
- **Sync Delay:** You can increase or decrease the sync delay. The scale goes from -10 000 µs to +10 000 µs with a step of 100 µs.

### Choosing the desired output mode

The following output modes are available:

- **AutoStereo:** Automatic mode (2D input = 2D output, 3D input = Active Stereo output).
- **Mono:** Forces all source signals to 2D output.
- **ActiveStereo:** Forces all source signals to Active Stereoscopic 3D.

Use the following table as an indicator of what display mode you require.

Source signal	AutoStereo	Mono	ActiveStereo
2D Source	Output is a 2D image	Output is a 2D image	Output is in Active Stereo
Active Stereo source	Output is in Active Stereo	Output is a 2D image	Output is in Active Stereo
Passive Stereo source	Output is in Active Stereo	Output is a 2D image	Output is in Active Stereo



When a different Display Mode is chosen compared to the source signal (e.g. Active Stereo source with Mono output), advanced image processing will make sure you a desirable image will be displayed.



If a 3D emitter is used that radiates infrared beams (IR beams), the IR beams may interfere with the IR communication between projector and the RCU. If such interference occurs, connect the RCU to the projector using the remote cable. It is also advised to turn the IR receivers on the projector off to avoid the 3D emitter interference. To turn off the IR receivers, see [“Pulse RCU, function of the on/off button”, page 31.](#)

### How to adjust the projector to the 3D emitter?

1. In the main menu, select *Installation* → *3D Setup*.

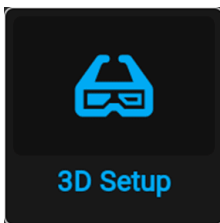

Image 8–84 Installation menu, 3D setup

The 3D setup menu is displayed.

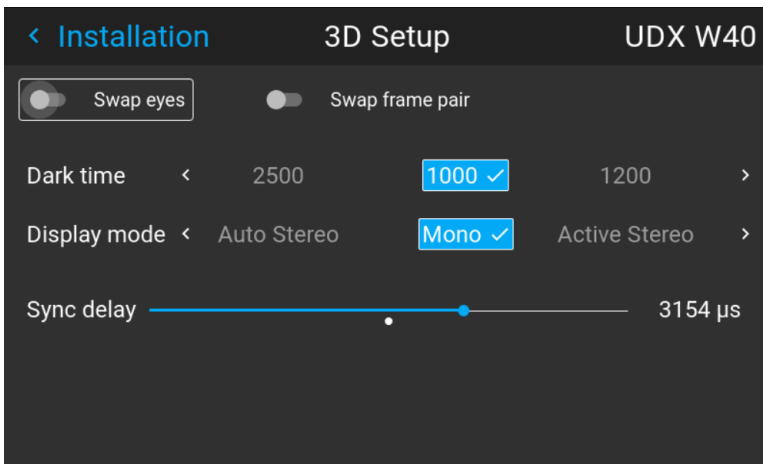

Image 8–85 Example of the 3D setup menu on a UDX

2. If it is necessary to invert the stereo sync output, enable the *Swap eyes* option.
3. If the projected moving 3D content doesn't look smooth enough, enable the *Swap frame pair* option to help improve this.
4. Select the desired the stereo *Dark Time*.
5. Select the desired *Display mode*.
6. Use the slider to set the desired stereo *Sync delay*.

# GUI – Profiles

# 9

9.1	Profiles introduction .....	116
9.2	Profiles setup parameters.....	116
9.3	Saving settings to a new profile.....	117
9.4	Deleting a projector profile.....	119

## 9.1 Profiles introduction

### About Profiles

The profile function makes it possible to store different profiles / projector setups for different use cases, and quickly recall them when needed. This means that it is not necessary to enter a lot of different menus to adjust the projector setup for specific recurring use cases. Due to the limited nature of this function and to avoid terminology confusion with more complex macro's, these are not called “macro's”, but “profiles”.

A few examples of different user cases are:

- Building temporary gaming setups in bright auditorium-level environment, versus a darker “gaming room” or “cave”.
- Playing content from an old DVD versus playing the latest release from an HDR-coded Blu-Ray.
- A rental projector that can be rented out for business presentations, concerts and other events that have different but recurring forms of content.

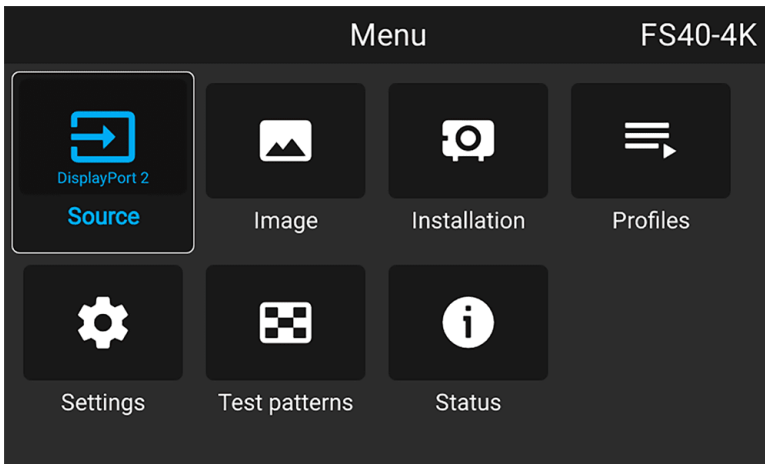

Image 9–1

## 9.2 Profiles setup parameters

### Available profile settings

Profile domain name	Settings saved
Illumination	<ul style="list-style-type: none"> <li>• Illumination power for each source</li> <li>• Light sensor enabled / disabled</li> <li>• Light sensor set point</li> </ul>
Source	Active source selection & EDID
Image	<ul style="list-style-type: none"> <li>• Contrast</li> <li>• Brightness</li> <li>• Saturation</li> <li>• Sharpness</li> <li>• Gamma</li> <li>• Used gamma type</li> <li>• Digital zoom (width / height / factor + enabled/disabled)</li> <li>• Digital shift (x / y + enabled / disabled)</li> <li>• Output resolution</li> </ul>
Display (3D settings)	<ul style="list-style-type: none"> <li>• 3D Display mode used</li> <li>• Swap eyes on / off</li> <li>• Swap frame pair on / off</li> <li>• Dark time and sync delay values</li> </ul>
Realcolor™	<ul style="list-style-type: none"> <li>• Brilliant Color mode (if available)</li> </ul>

Profile domain name	Settings saved
	<ul style="list-style-type: none"> <li>• P7 desired values</li> <li>• P7 measured values</li> </ul>
Warp	<ul style="list-style-type: none"> <li>• Warp status enabled / disabled</li> <li>• Screen size</li> <li>• Warp file selected (if available)</li> <li>• Transport delay</li> </ul> <p><b>Note:</b> Bow and 4 corners warp cannot be saved.</p>
Blend	<ul style="list-style-type: none"> <li>• Blend mask enabled / disabled</li> <li>• All Masks (top / bottom / left / right) and heights (top / bottom / left / right)</li> <li>• Blend files enabled / disabled (if available)</li> <li>• Blend file selected (if available)</li> </ul>
Black level	<ul style="list-style-type: none"> <li>• Black level file enabled / disabled</li> <li>• Black Level file selected (if available)</li> <li>• Basic black level enabled / disabled</li> <li>• Black level settings (top / bottom / left / right)</li> <li>• RGB gain values (Red, Green and Blue values)</li> </ul>
PQ (HDR)	<ul style="list-style-type: none"> <li>• Screen luminance (unit and value)</li> <li>• HDR Boost value</li> <li>• DynaBlack mode</li> </ul>
Installation	<ul style="list-style-type: none"> <li>• Lens parameters (lens zoom, focus, shift and iris (if available))<sup>4</sup></li> <li>• Orientation (mounting &amp; projection)</li> <li>• Scaling mode</li> <li>• Position of motorized frame (if used).</li> <li>• Shutter status (open or closed).</li> </ul>
Cooling <sup>5</sup>	Selected Cooling mode

## 9.3 Saving settings to a new profile

### How to save the current projector settings?

1. Adjust the necessary projector set up values for the actual user case as described in the specific topics in this manual.
2. Enter the menu *Profiles*

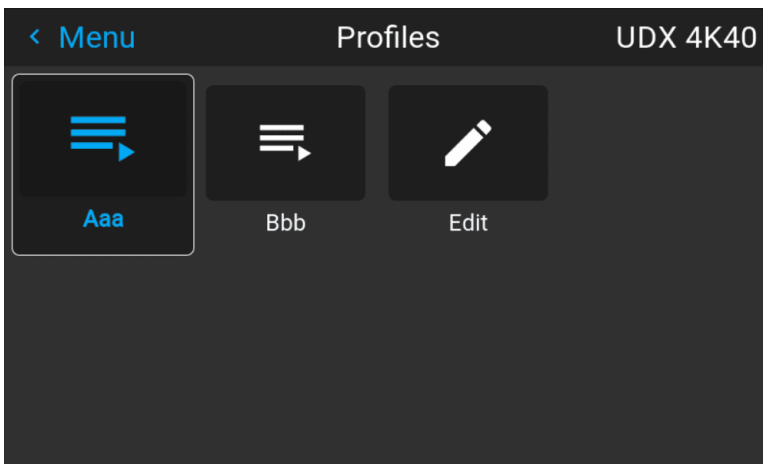

Image 9–2

3. Select the *Edit* button

4. only valid if recalled with same lens  
 5. Only if external cooler is installed



Image 9-3

The Profile edit menu shows up.

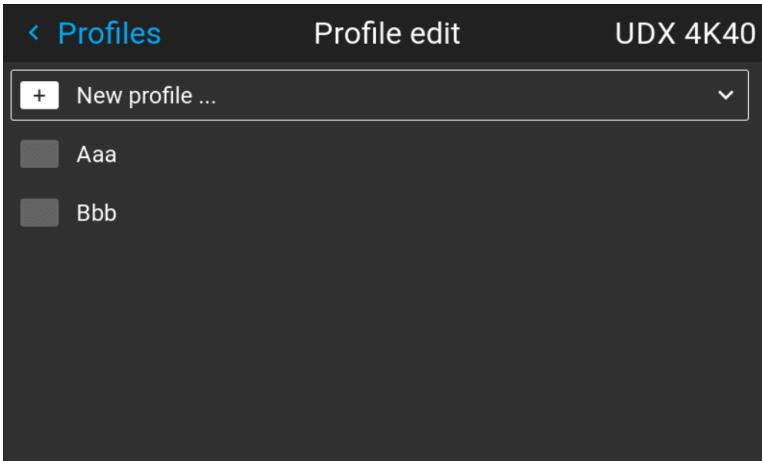

Image 9-4

4. Select New profile

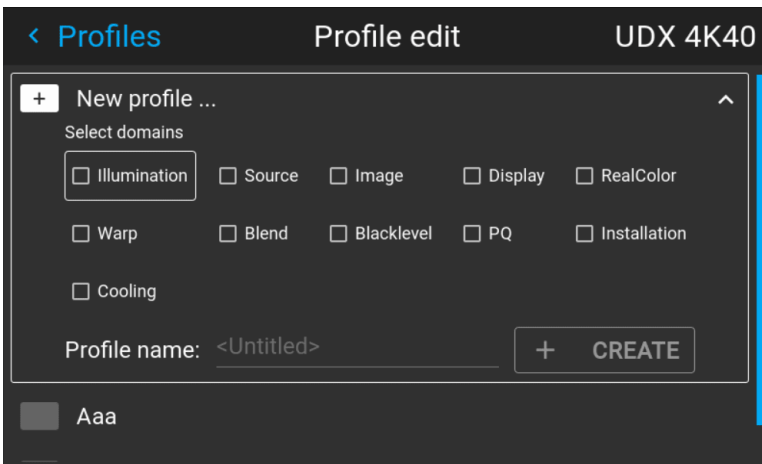



Image 9-5

5. Enter a suitable name for this profile via the pop up keyboard (arrow keys and OK (✓) to select). End the name entry by selecting the “return” key on the pop up keyboard.

6. Select the “Assign to preset slot”. A drop down menu will show up, select the preferred value.

 **Note:** The function “**Assign to preset slot**” enables a shortcut to the actual profile from the remote control. If assigned preset slot are set to 1, this profile can be recalled by pressing the key MACRO and then 01 on the remote control. It is not a requirement to use this function, just an option.

 **Note:** The maximum number of profile presets is 30.

7. Select the domains in the menu that shall be stored in the profile.

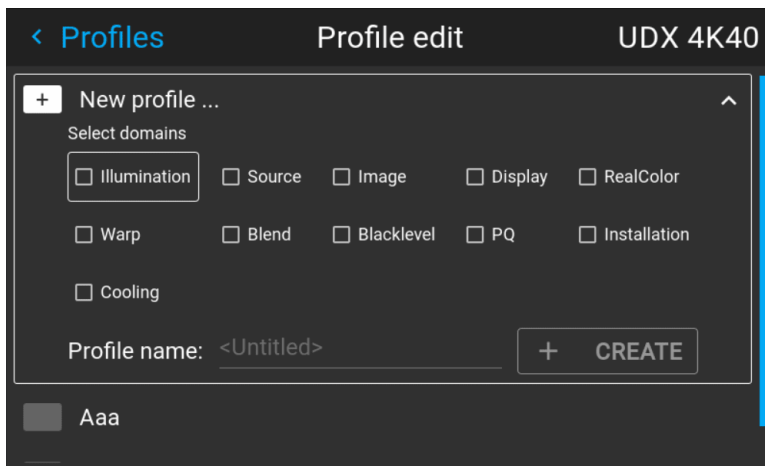

Image 9–6 Select domains

8. Select “Profile name”. A keyboard will show up, and enter a proper name for the profile.
9. Select “create” and confirm by the OK button.  
The new profile is now created and saved.
10. Repeat step 1 to 6 for creating of more profiles.

### Recall a profile.

1. Enter the *Menu/ Profile*

The stored profiles will be visible in the menu. Select the actual profile.

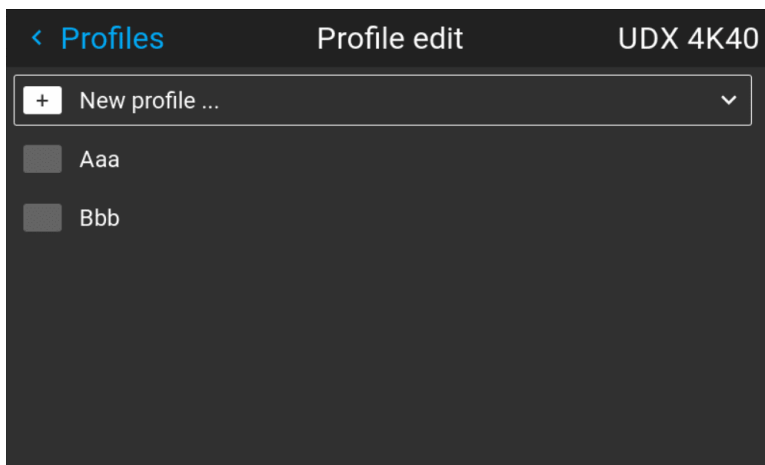

Image 9–7

or

Select the numeric shortcut from the remote control.

## 9.4 Deleting a projector profile

### How to delete a profile

1. In the main menu, select *Profiles* → *Edit*.

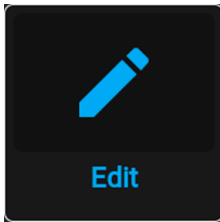

Image 9–8 Profiles menu, edit

The edit menu is displayed.

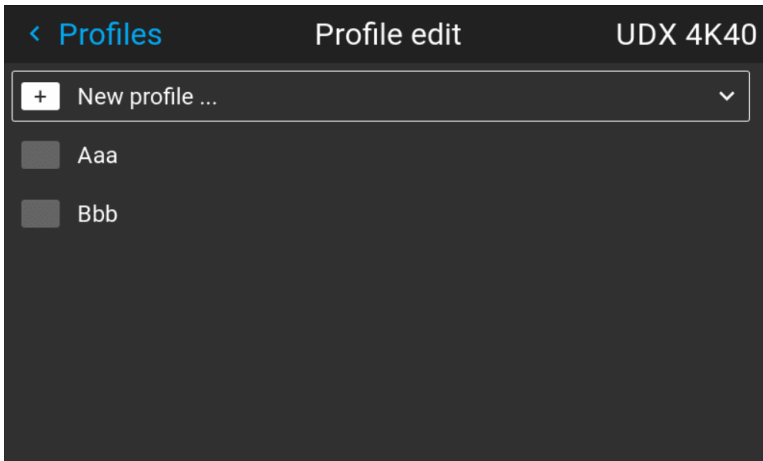

Image 9–9 Profile edit menu

2. Select the undesired projector profile and confirm to expand it.

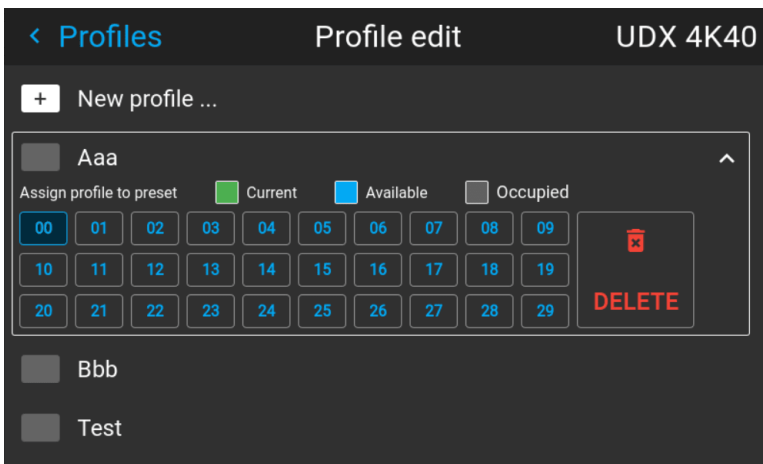

Image 9–10 Example of a projector profile with available preset slots

3. Use the arrow keys to select *Delete* and confirm. confirm the delete action.



# GUI – System Settings

# 10

10.1 Remote control.....	122
10.2 Host name - custom projector name setup.....	124
10.3 Communication, LAN setup.....	125
10.4 DMX.....	133
10.5 Front XLR output voltage control.....	135
10.6 GSM configuration.....	135
10.7 Changing the User Interface language.....	136
10.8 Themes.....	137
10.9 Units (measurement) system setup.....	138
10.10 Controlling the backlight of the LCD Display.....	138
10.11 Date and time setup - manually.....	139
10.12 Date and time setup - automatically.....	140
10.13 Power saving settings.....	142
10.14 Lens features.....	143
10.15 Factory reset.....	144
10.16 Lens Calibration.....	148
10.17 Flex brightness.....	149
10.18 Rigging frame Calibration.....	150
10.19 Electronic Convergence.....	151
10.20 Operational mode.....	153
10.21 Capture mode.....	154
10.22 Login to advanced settings.....	154
10.23 List of open source licenses.....	155

## 10.1 Remote control

### 10.1.1 Broadcast address

#### About broadcast address

Broadcast address is a common address that can be set on the projector. That can be “0” or “1”. The default broadcast address is '0'.

Any command coming from an RCU programmed with that common address will be executed.

#### How to the broadcast address

1. In the main menu, select *Settings* → *Communication* → *Remote control*.

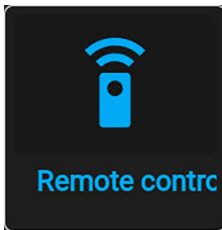

Image 10–1 Communication menu, Remote Control

The Remote control menu is displayed.

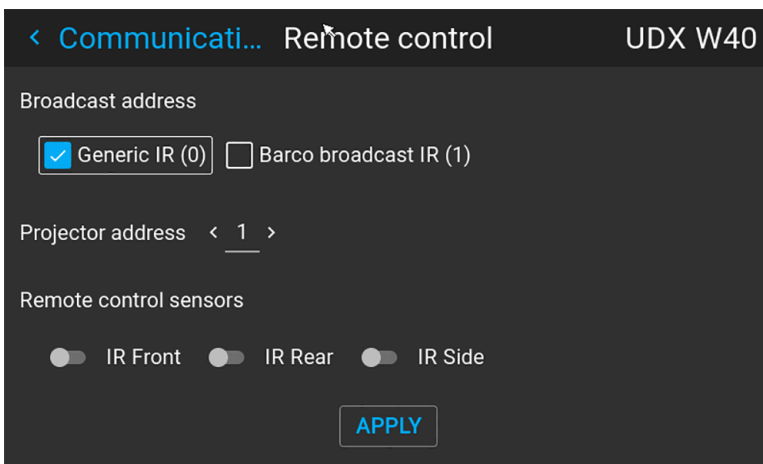

Image 10–2 Example of the Remote control menu

2. To change the broadcast address select the radio button of your choice.

The following choices are possible:

- Generic IR (address 0)
- Barco broadcast IR (address 1)

3. Select **APPLY** and click **OK** to apply the changes.

### 10.1.2 Projector address

#### About individual projector address

As more than one projector can be installed in a room, each projector should be separately addressable with an RCU or with a computer using serial communication. Therefore each projector has its own address. The factory default individual projector address is '0'.

When the address is set, the projector can be controlled with the RCU. Only addresses between 0 and 31 are supported for the RCU.

Next to an individual projector address, each projector has also a broadcast address for group control.

## How to change

1. In the main menu, select *Settings* → *Communication* → *IR control*.

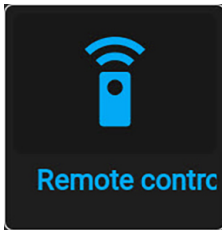

Image 10–3 Communication menu, Remote Control

The Remote control menu is displayed.

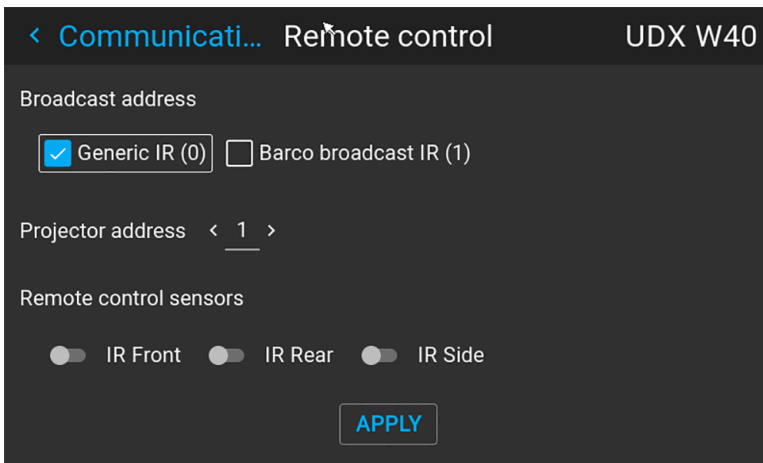

Image 10–4 Example of the Remote control menu

2. Select the current projector address and enter a new address.
3. Select **APPLY** and click **OK** to apply the changes.

From now on the projector will only listen to this new address and to its broadcast address.

### 10.1.3 IR sensors

#### What can be done?

Each IR sensor can be individually disabled or enabled.

When all sensors are turned off, the projector will no longer respond to signals from the remote control. To re-enable the sensors, use the menu keypad on the projector.

#### How to disable

1. In the main menu, select *Settings* → *Communication* → *IR Control*.

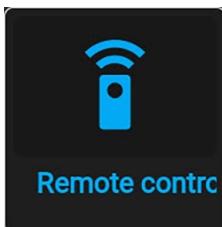

Image 10–5 Communication menu, Remote Control

The IR control menu is displayed.

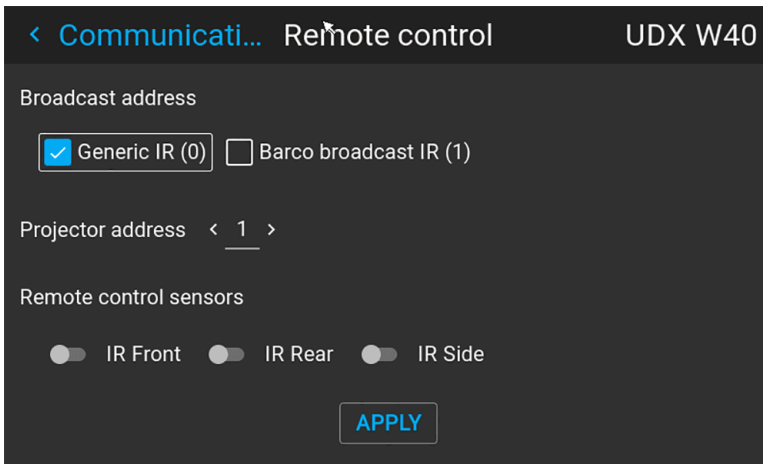

Image 10–6 Example of the IR control menu

2. To disable an IR sensor, select the slider and drag to the left.  
A blue slider means an active IR sensor.  
A gray slider means an inactive IR sensor.
3. Select **APPLY** and click **OK** to apply the changes.

## 10.2 Host name - custom projector name setup

### What can be done?

The default host name of the projector is the projector type along with the serial number of your projector (e.g. “UDX-4K40-0123456789”).

You can change this name to make it easier to spot in a network with multiple devices or projectors

### How to set a different Host name

1. In the main menu, select *Settings* → *Communication* → *Host name*.

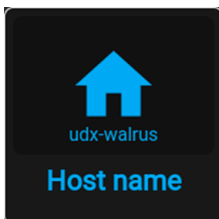

Image 10–7 Communication menu, Host name

The Host name menu is displayed.

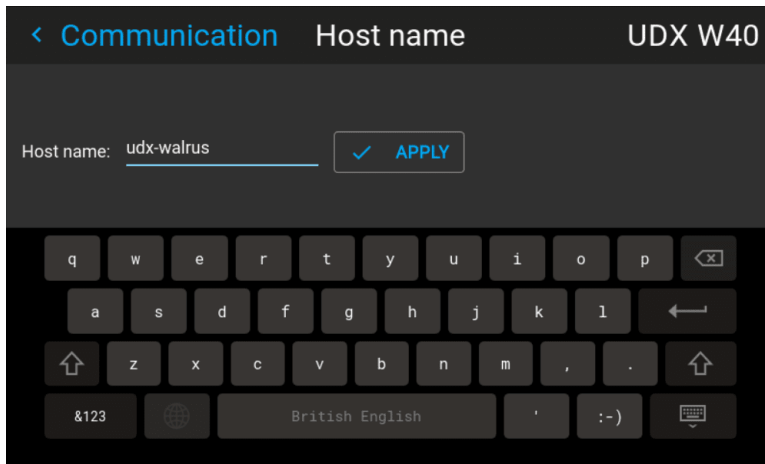

Image 10–8 Example of the host name menu

2. Press confirm to edit the *Host name* field.
3. Use the digital keyboard to change the Host name to the desired custom name.
4. Press the OK key, or press the enter icon to confirm the typed name. Click *Apply to update the host name*.

## 10.3 Communication, LAN setup

### About a network connection

A network connection can be made via a wired connection or via the optional wireless unit.

#### 10.3.1 Introduction to a Network connection

##### **DHCP**



Dynamic host configuration protocol. DHCP is a communications protocol that lets network administrators manage centrally and automate the assignment of IP addresses in an organization's network. Using the Internet Protocol, each machine that can connect to the Internet needs a unique IP address. When an organization sets up its computer users with a connection to the Internet, an IP address must be assigned to each machine. Without DHCP, the IP address must be entered manually at each computer and, if computers move to another location in another part of the network, a new IP address must be entered. DHCP lets a network administrator supervise and distribute IP addresses from a central point and automatically sends a new IP address when a computer is plugged into a different place in the network.



##### **IP**

Internet Protocol. The network layer of TCP/IP. Required for communication with the internet.



##### **Subnet mask**

A number that is used to identify a subnetwork so that IP addresses can be shared on a local area network.



##### **Default Gateway**

A router that serves as an entry point into and exit point out of a network. For example, a local network (LAN) may need a gateway to connect it to a wide area network (WAN) or to the Internet.



##### **MAC address**

Media Access Control address. Unique hardware number, used in combination with the IP-address to connect to the network (LAN or WAN).

## What should be set up for an Ethernet address?

Two ways can be used to assign an address:

- use the *Automatic* setting so that an automatic address will be assigned.
- Assign manually an IP address, Net-mask (subnet-mask), (default) gateway address.
  - Set the IP-Address field to the desired value. This must NOT be 0.0.0.0 for static IP-Address assignment. The IP address identifies a projector's location on the network in the same way a street address identifies a house on a city block. Just as a street address must identify a unique residence, an IP address must be globally unique and have a uniform format.
  - Set the Subnet-Mask as appropriate for the local subnet.
  - Set the Default-Gateway to the IP-Address of the local router (MUST be on the local subnet!) on the same network as this projector that is used to forward traffic to destinations beyond the local network. This must not be 0.0.0.0. If there is no router on the projector's local subnet then just set this field to any IP-Address on the subnet.

### 10.3.2 Wired IP address set up

#### How to automatically set up the IP address

1. In the main menu, select *Settings* → *Communication* → *LAN*.

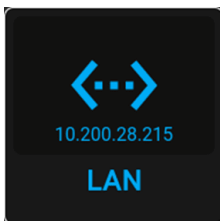

Image 10–9 Communication menu, LAN

The LAN menu is displayed.

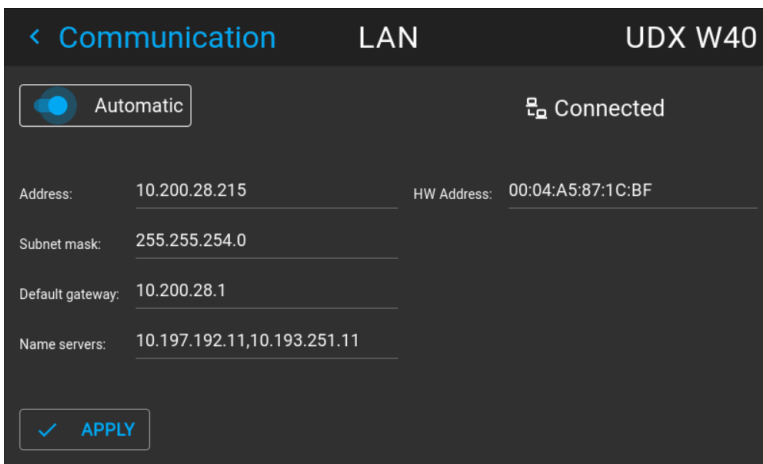

Image 10–10 Example of the LAN menu

2. To enable Automatic, make sure the Automatic slider is set to the right. The color of the slider will be blue. An IP address will be automatically assigned if it can make a connection to the network.. When connected, it is indicated with the connection symbol and the indication *Connected*.
3. Select **APPLY** and confirm.

#### How to manually set up the IP address

1. In the main menu, select *Settings* → *Communication* → *LAN*.

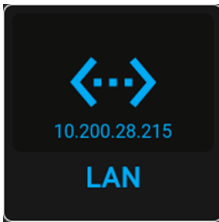

Image 10–11 Communication menu, LAN

The LAN menu is displayed

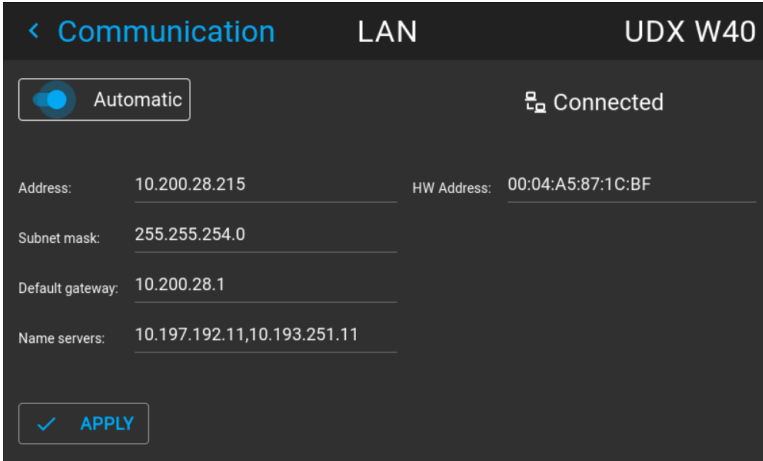

Image 10–12 Example of the LAN menu

2. Disable the Automatic slider. The slider becomes gray.
3. Use the arrow keys to select *Address* and press **OK** button to activate the input box.

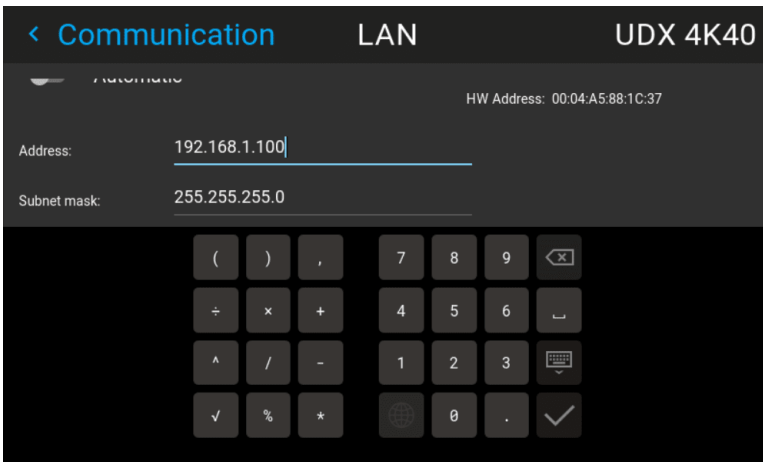



Image 10–13 Example of entering the IP address

4. Use the arrow keys and enter key to enter in the IP address.
  -  **Note:** Digits can be entered with the digit keys on the remote control or the local keypad. When a digit is entered in that way, the next character will be selected automatically.
5. Once filled in, select the ✓ symbol and confirm.
6. Repeat steps 4 and 5 for the Subnet mask and Default Gateway.
7. Select **APPLY** and click **OK** to confirm all changes.

When the connection is established, it is indicated with the connection symbol and the indication *Connected*.

### 10.3.3 Wireless IP address set up

#### When can the wireless IP address be used?

When the optional WiFi module has been installed on the projector, you can configure the projector in such a way it can access the network via WiFi instead of a LAN cable.

For more information on how to install the WiFi module, please refer to the installation manual.

#### How to connect to a wireless network?

1. In the main menu, select *Settings* → *Communication* → *WiFi*.



Image 10–14 Communication menu, WiFi

The WiFi menu is displayed.

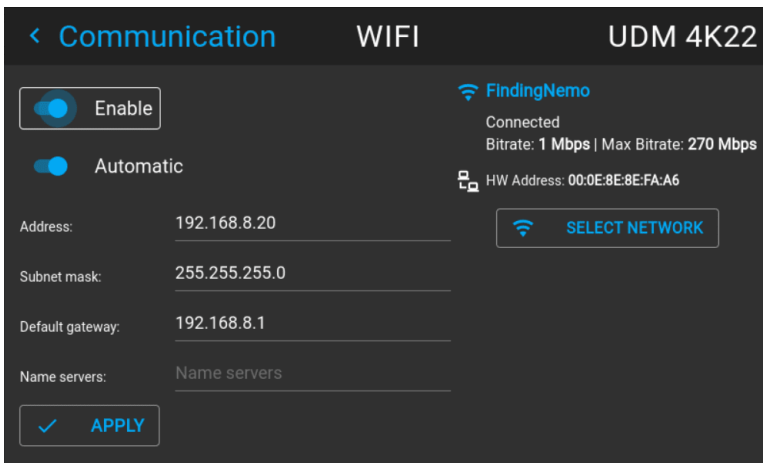

Image 10–15 Example of the WiFi menu

2. Make sure the *Enable* slider is set to the right to enable the WiFi module. The color of the slider becomes blue.
3. Make sure the *Automatic* slider is set to the right to automatically assign an IP address.
4. Use the *Select Network* button to select the desired network from the available list.

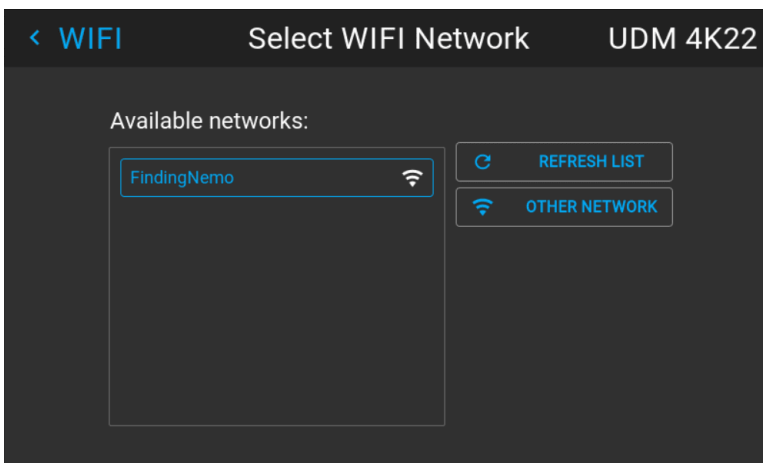



Image 10–16 Example of the available networks list.



-  *Tip:* If the desired wireless network is not in the list or hidden by default, select *Other network*. A form will pop up, allowing you to fill in the details of the network.

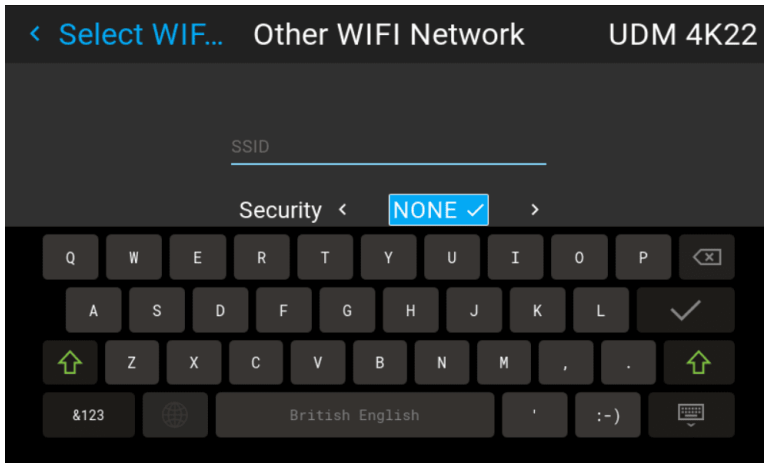



Image 10–17 Example of the entry form to search for other wireless networks

- If required by the chosen wireless network fill in the user name, password and confirm.

-  *Tip:* If you already connected to this network in the past using this projector, the software will remember the user name and password, ensuring you do not have to fill this in again.

- Press *Connect* to connect to the selected network.

- If required by the chosen wireless network, fill in the user name and password and confirm.

An automatic IP address is assigned.

When connected to this network, it is indicated in the upper right corner of the menu with the term “connected”.

### How to manually set up the IP address

- In the main menu, select *Settings* → *Communication* → *WiFi*.

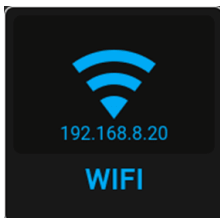

Image 10–18 Communication menu, WiFi

The WiFi menu is displayed.

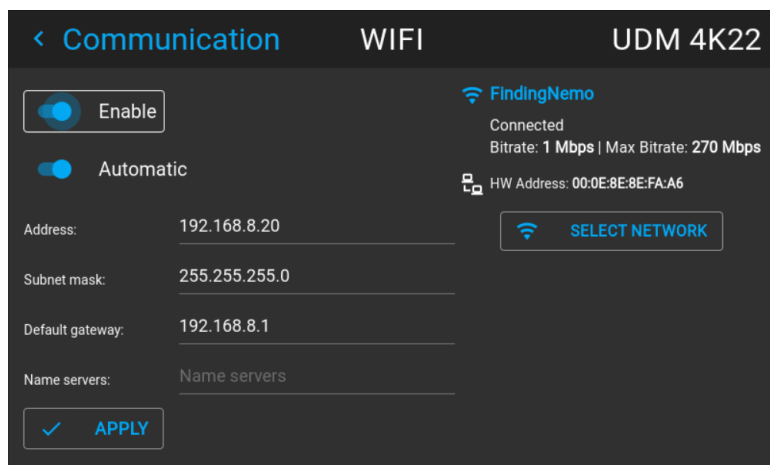

Image 10–19 Example of the WiFi menu

2. Make sure the *Enable* slider is set to the right to enable the WiFi module. The color of the slider becomes blue.
3. Disable the *Automatic* slider by setting it to the left. The switch becomes gray.

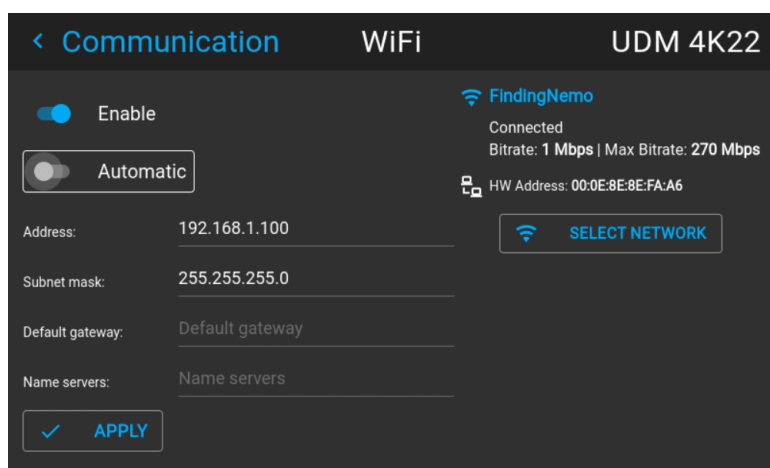



Image 10–20

4. Use the arrow keys to select *Address* and press **OK** button to activate the input box.
5. Use the arrow keys and enter key to enter in the IP address.

 **Note:** Digits can be entered with the digit keys on the remote control or the local keypad. When a digit is entered in that way, the next character will be selected automatically.

6. Once filled in, select the ✓ symbol and confirm.
7. Repeat steps 4 and 5 for the Subnet mask and Default Gateway.
8. Select **APPLY** and click **OK** to confirm all changes.
9. Select the *Select Network* button to select the desired wireless network from the list.

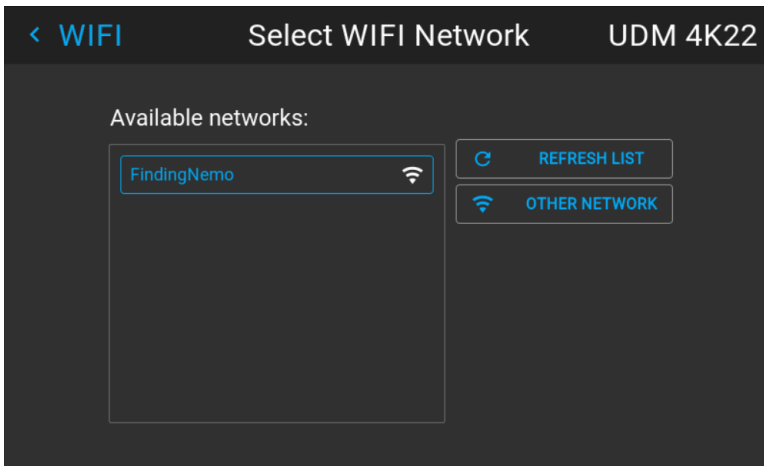

Image 10–21 Example of the available networks list.

10. Press *Connect* to connect to the selected network.
11. If required by the chosen wireless network, fill in the username and password and confirm.  
When connected to this network, it is indicated in the upper right corner of the menu with the term “connected”.

### 10.3.4 LAN over HDBaseT™ IP address set up



LAN over HDBaseT is only supported on HDBaseT™ Input 1 on the Pulse Quad Combo Input board Mk II.

#### About LAN over HDBaseT™

When a LAN cable is mounted in HDBaseT™ input 1, the HDBaseT™ menu will appear in the Settings menu. Using the menu, you can assign a custom IP address, or leave the automatic IP address setup.



Keep into account that the HDBaseT™ network will be unavailable if the projector is in Standby mode or ECO mode (whichever is applicable to your projector). If you want to use this connector as your main network connection, it is thus advised to disable the standby or ECO mode. For more info, see power settings.

#### How to automatically set up the IP address

1. In the main menu, select *Settings* → *Communication* → *HDBaseT™*.

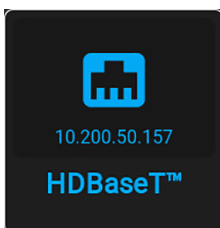

Image 10–22 Communication menu, HDBaseT™

The HDBaseT™ menu is displayed.

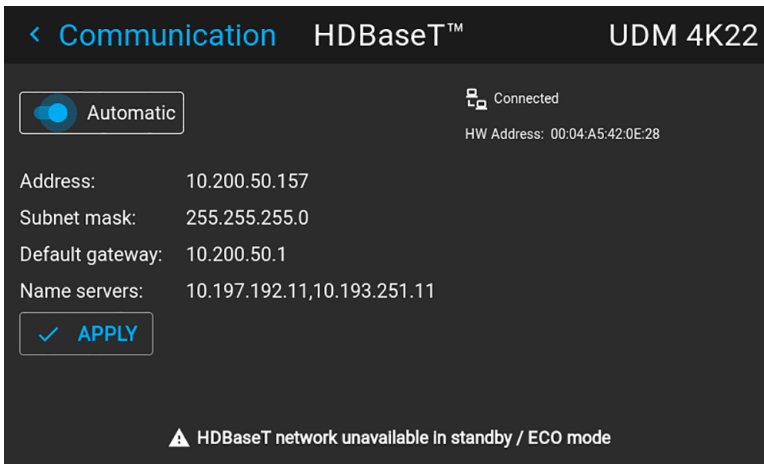

Image 10–23 Example of the HDBaseT™ menu

2. To enable Automatic, make sure the Automatic slider is set to the right. The color of the slider will be blue. An IP address will be automatically assigned if it can make a connection to the network.. When connected, it is indicated with the connection symbol and the indication *Connected*.
3. Select **APPLY** and confirm.

### How to manually set up the IP address

1. In the main menu, select *Settings* → *Communication* → *HDBaseT™*.

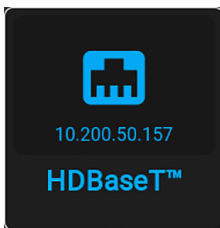

Image 10–24 Communication menu, HDBaseT™

The HDBaseT™ menu is displayed.

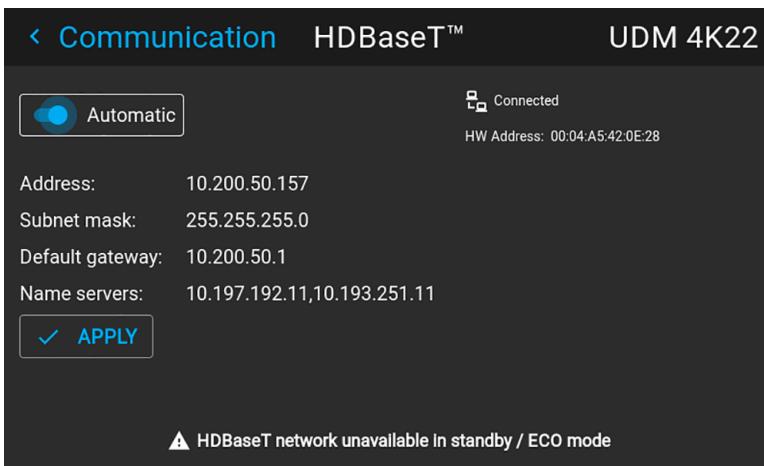

Image 10–25 Example of the HDBaseT™ menu

2. Disable the Automatic slider. The slider becomes gray.
3. Use the arrow keys to select *Address* and press **OK** button to activate the input box.

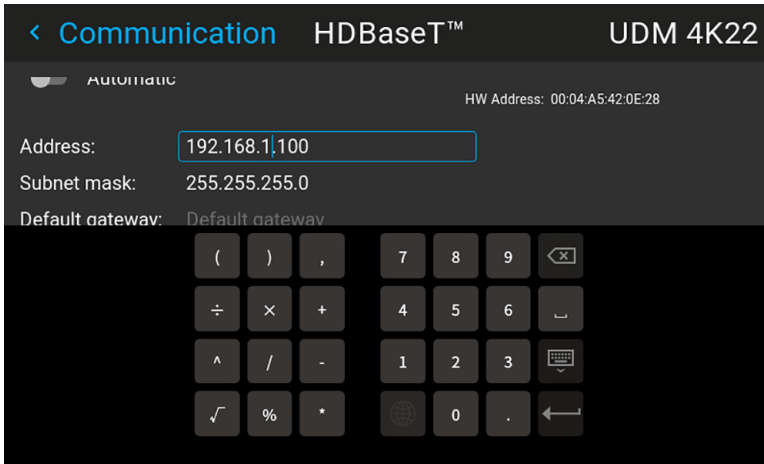



Image 10–26 Example of entering the IP address

4. Use the arrow keys and enter key to enter in the IP address.

 **Note:** Digits can be entered with the digit keys on the remote control or the local keypad. When a digit is entered in that way, the next character will be selected automatically.

5. Once filled in, select the Enter symbol and confirm.
6. Repeat steps 4 and 5 for the Subnet mask and Default Gateway.
7. Select **APPLY** and click **OK** to confirm all changes.

When the connection is established, it is indicated with the connection symbol and the indication *Connected*.

## 10.4 DMX

### About the ways to control the projector via DMX

DMX signals can be connected to the DMX In port on the communicator interface when using a standard DMX cable equipped with XLR connector. The DMX out can be used to create a chain of DMX devices. One universe can control up to 512 channels.

If you are using a DMX console and other automated lighting products compatible with Art-Net, the Ethernet network can serve as the link for DMX control. All DMX controls can be sent over the Ethernet cable. Multiple universes are possible.

For a full list of all DMX channels, values and possible actions, see “DMX chart”, page 193.

### About the DMX menu

DMX Feature	What can be done?
DMX Mode	Two different modes for DMX are available. <ul style="list-style-type: none"> <li>• <b>Basic:</b> A basic configuration where 2 channels are implemented.</li> <li>• <b>Extended:</b> A full configuration, spread over 14 channels.</li> </ul> For the full mapping of each used channel, refer to the DMX chart in the appendices. See “DMX chart”, page 193.
Start Channel	Before a projector can execute DMX commands, a unique address (named DMX address or Starting channel) should be given to the projector. This address can vary from 1 to 512.
DMX Monitor	If a DMX device is connected, the settings per channel can be displayed via the <b>Monitor</b> button.
Reset for Max intensity	You can change the Shutter and intensity via DMX Channel 1 (both in Basic and Extended mode).

DMX Feature	What can be done?
	If no DMX signals are available, you can reset the intensity value to its default (maximum) value of 255 using the <b>Max Intensity</b> button.
Auto power down	The projector can be forced to shut down after a certain time-out period if no DMX signals are available. <b>Note:</b> Value is set in minutes.
DMX Art-Net	DMX can be sent via the Ethernet connector to the projector instead of the classic DMX connector. This function can be enabled or disabled. Art-Net is generally used when more than 512 addresses are used in your setup.
DMX Art-Net Universe	<b>Note:</b> DMX Art-Net Universe can only be used when Art-Net DMX is enabled. If Art-Net is enabled, you can specify which DMX universe this projector belongs to.
Front XLR connector	If available on your projector, the power of the XLR connector on the front side of the projector can be enabled and set to a desired value. <b>Note:</b> If no front XLR connector is available on your projector, this option remains hidden.

## How to set up DMX?

1. In the main menu, select *System Settings* → *Communication* → *DMX*.

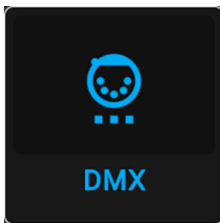

Image 10–27 Communication menu, DMX

The DMX menu is displayed.

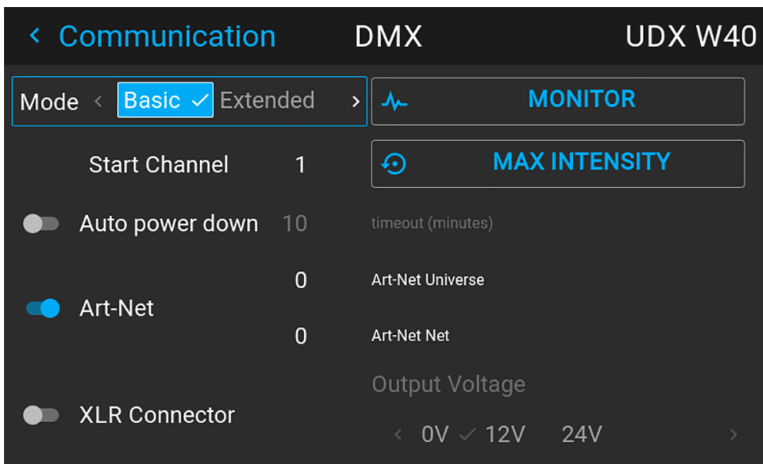

Image 10–28 Example of the DMX menu

2. Choose the desired DMX mode.
3. Choose the desired starting channel.
4. Choose whether or not you want the Auto power-down feature to be enabled. If enabled, determine the time-out.
5. If required, enable Art-Net. If enabled, determine the desired Art-Net Universe and Art-Net channel.
6. If a front XLR connector is available on your projector, you can enable the output voltage on this connector.

## 10.5 Front XLR output voltage control

### What can be done?

The output voltage on the front XLR connector can be enabled or disabled. If enabled, the output voltage level can be set to 0 V, 12 V or 24 V.

The output voltage will depend on the application or peripheral used. For example, the optional external mechanical shutter requires 12 V. The motorized rigging frame on the other end requires 24 V.

### How to enable or disable?

1. In the main menu, select *System Settings* → *Communication* → *DMX*.

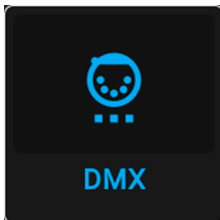

Image 10–29 Communication menu, DMX

The DMX menu is displayed.

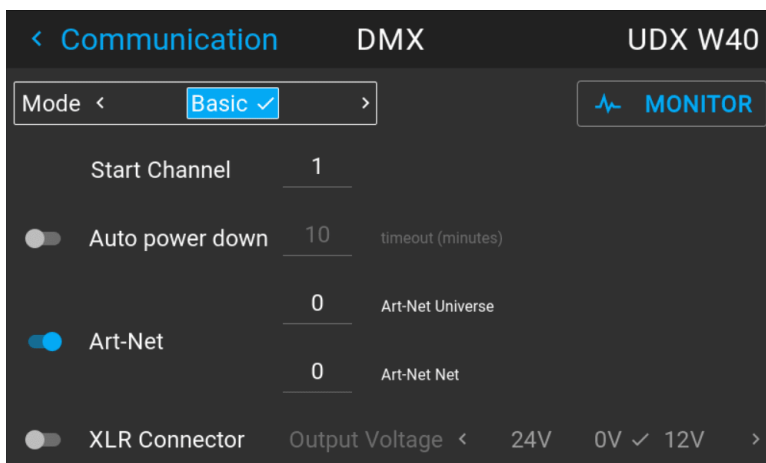

Image 10–30 Example of the DMX menu

2. On the bottom of the DMX menu, **Enable** the *XLR connector* slider.
3. Select the desired *Output Voltage*.

## 10.6 GSM configuration



Only possible when a GSM module with SIM card is installed in the projector.

### When to use the GSM menu

The GSM menu by itself does not have any functionality. The main purpose of this menu is to read out the necessary data from the SIM card in the GSM module.

You may require this information when using specific connectivity functions (e.g. configuring the Projector Management Suite in a mobile-only setup).

## About the SIM card PIN code

To configure the projector software with the installed SIM card for the first time, a correct PIN code (4 digits) must be entered.



As the PIN code cannot be checked with the one on the SIM card, ensure to enter the correct PIN code.



When your SIM card is blocked, you have to remove the SIM card from the GSM module and to insert the SIM card in a mobile phone so that you can enter the PUK code to unblock the SIM card.

## How to activate

1. In the main menu, select *Settings* → *Communication* → *GSM*.



Image 10–31 Communication menu, GSM

At first use, the GSM pin code input menu is displayed. If a correct pin code has been entered in the past, it will not be necessary to enter the pin code again and you can skip the next step.

2. Enter the 4 digits of the PIN code and confirm.

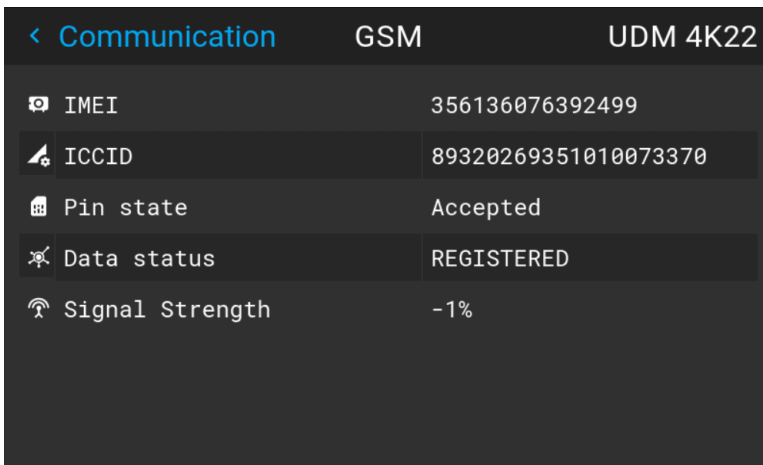

Image 10–32 Example of the GSM menu once the pin code has been applied

## 10.7 Changing the User Interface language

### How to change the language of the user interface

1. In the main menu, select *Settings* → *User interface* → *Language*.

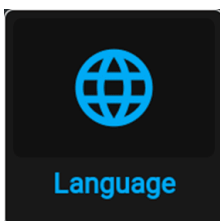

Image 10–33 Interface



The Language menu is displayed.

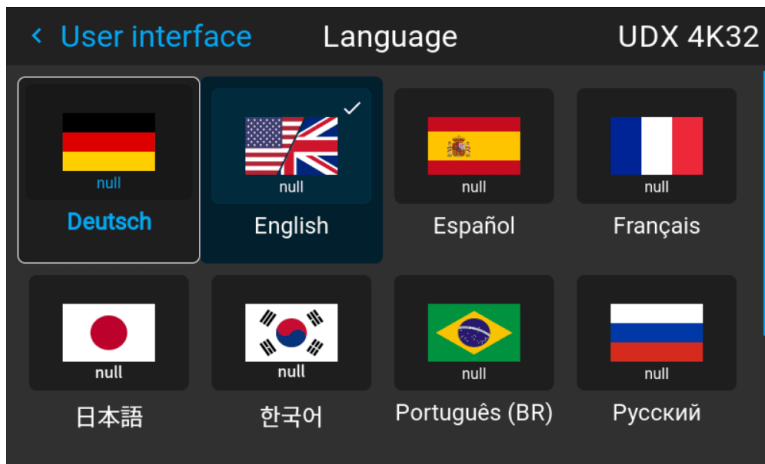

Image 10–34 Example of the Language menu

2. Select the desired language. You can choose between the following:
  - German (DE)
  - English (EN)
  - Spanish (ES)
  - French (FR)
  - Japanese (JA)
  - Korean (KO)
  - Portuguese (PT-BR)
  - Russian (RU)
  - Chinese (ZH)

## 10.8 Themes

### About Themes

Themes are used to apply a predefined functionality to the OSD display. There are two options: light or dark (default).



While the default theme is dark, all images in this manual are taken while using the light theme.

### How to select a different interface theme

1. In the main menu, select *Settings* → *User interface* → *Themes*.

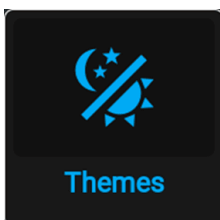

Image 10–35 Settings menu, themes

2. In the themes menu, select the desired *Theme*.  
You can choose one of the following: *Light*, or *Dark*.

## 10.9 Units (measurement) system setup

### About the measurement systems

You can use this menu to change the default measurement systems. By default the metric system is used. But you can choose between the following:

- Temperature: °C or °F
- Distance: meter, centimeter, feet or inch.

### How to set a different metric system

1. In the main menu, select *Settings* → *User interface* → *Units*.



Image 10–36 Settings menu, units

The Units menu is displayed.

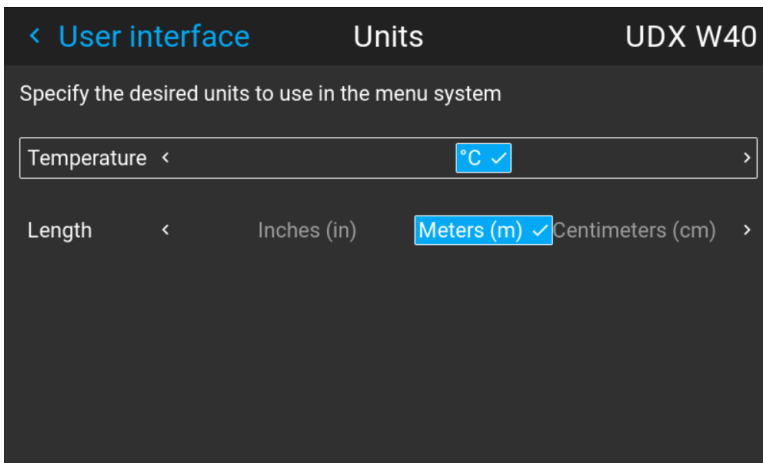

Image 10–37 Example of the Units menu

2. Select the desired *Temperature* unit and *Length* unit and confirm.

## 10.10 Controlling the backlight of the LCD Display

### What lighting can be controlled?

You can choose how quickly the backlight of the LCD turns off. You can select one of the default values, or enter a custom value.

### Stealth Mode

Alternatively, you can turn on **Stealth Mode** instead. By activating this mode, the backlight of the LCD, the backlight of all the buttons of the keypad and the indication LEDs for the LAN and HDbaseT inputs will be disabled.

**Stealth Mode** is enabled and disabled by pressing the OSD button on the remote control for 3 seconds.

### How to set the backlight

1. In the main menu, *Settings* → *User interface* → *Backlight*.

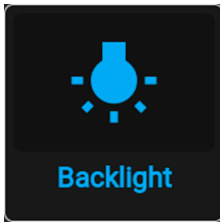

Image 10–38 Settings menu, backlight

The Backlight menu will be displayed.

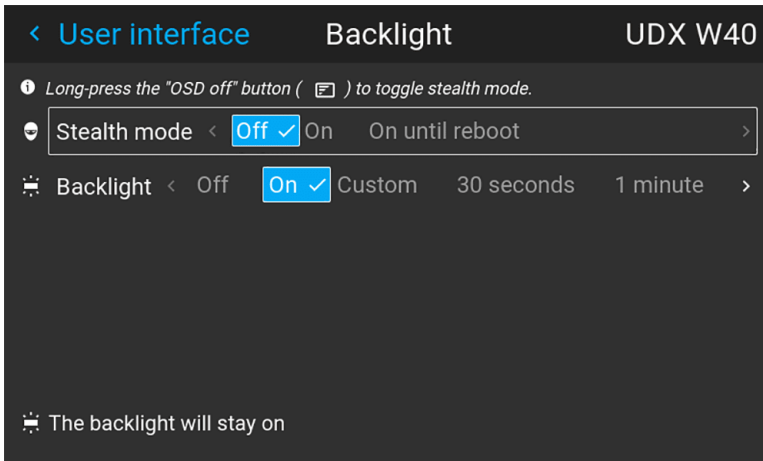

Image 10–39 Example of the backlight menu

2. Choose the desired setting for the backlights. Select one of the predetermined options, or a custom value.

## 10.11 Date and time setup - manually

### About date and time

The date and time setting can be set manually or automatically via an NTP server based on region and city location.



Date is displayed by default as: day / month / year.  
Time is displayed by default as: hour : minutes : seconds, in the 24-hour clock.

### How to set manually

1. In the main menu, select *Settings* → *Date and time*.

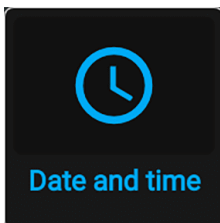

Image 10–40 Settings menu, Date and time

The Date and time menu is displayed.

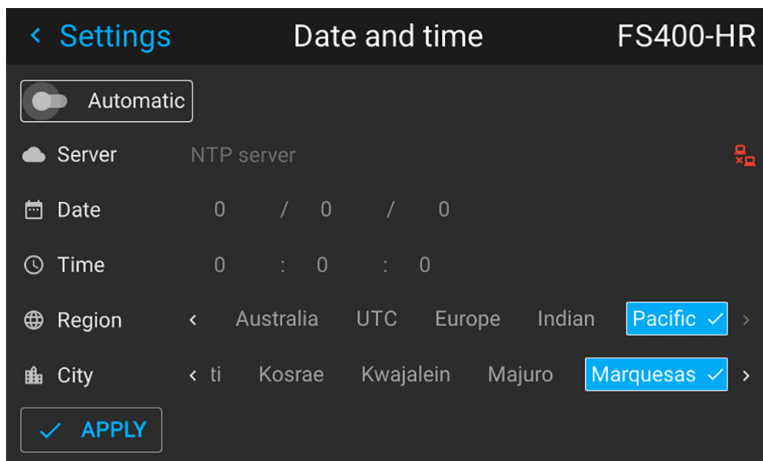

Image 10–41 Example of the Date and time menu

2. Disable the *Automatic* slider.  
 Gray slider: automatic is off  
 Blue slider: automatic is on
3. Select *Date*  
 The Date dialog is prompted. The active day is selected by default.
4. Slide the *Day*, *Month* and *Year* slider up or down until the desired date is obtained.  
 or  
 Alternatively, use the up, down and OK buttons on the RCU or control panel until the desired date is obtained.
5. Select *Time*.  
 The Time dialog is prompted. The active time is selected by default.
6. Slide the Hour, Minute and second slider up or down until the desired time is obtained.  
 or  
 Alternatively, use the up, down and OK buttons on the RCU or control panel until the desired time is obtained.
7. Select **Apply** to activate.

## 10.12 Date and time setup - automatically



Date is displayed by default as: day / month / year.  
 Time is displayed by default as: hour : minutes : seconds, in the 24–hour clock.

### To set date and time automatically

1. In the main menu, select *Settings* → *Date and time*.

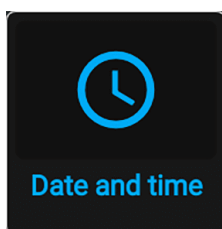

Image 10–42

The Date and time menu is displayed.

2. Enable the *Automatic* slider.

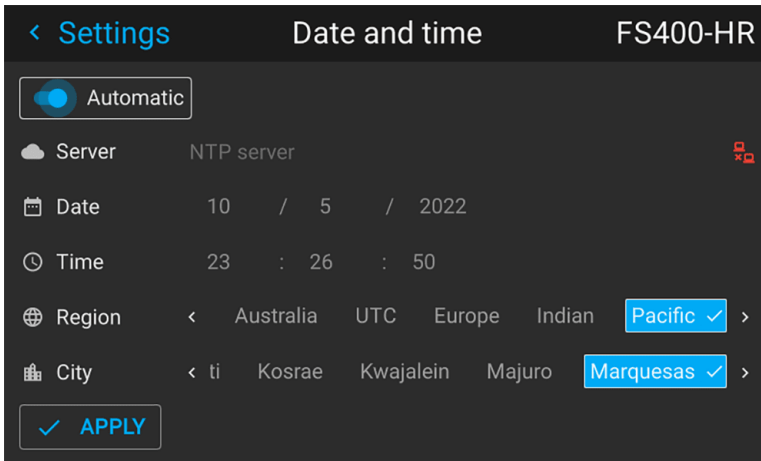

Image 10-43

Gray slider: automatic is off

Blue slider: automatic is on

3. Select *Server* and click **OK**.

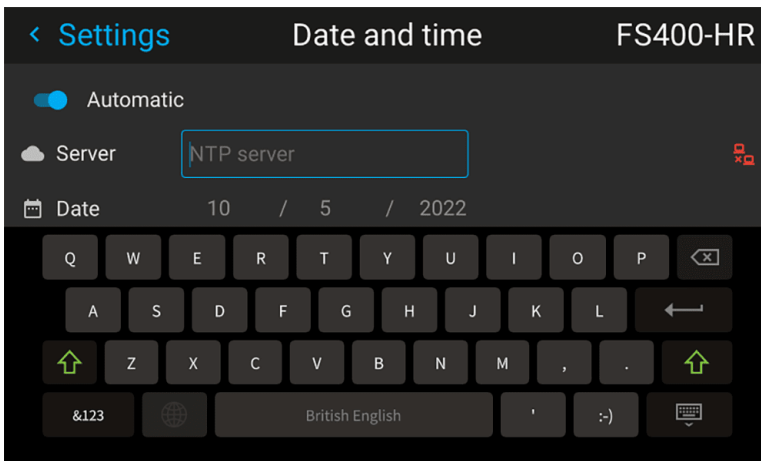

Image 10-44

4. Enter the name or the IP address of the NTP server.



*Tip:* In case you cannot connect to an external NTP server although you can PING this server, the connection is blocked by the local firewall policy. Contact your IT system administrator.

In case the connection is successful, a green icon appears at the right side of the server line.

5. Select *Region* and select with the arrow keys the region where the projector is installed.

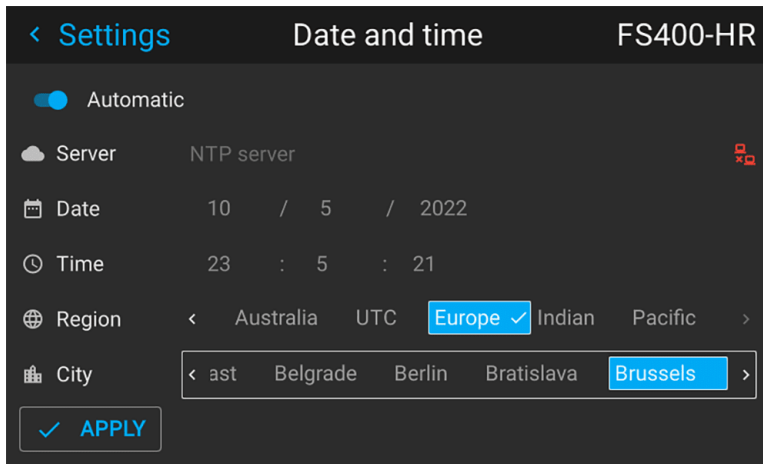

Image 10-45

The list of cities is updated according the selected region.

6. Select **City** and select the city corresponding with your time line.
7. Select **Apply** to activate.

## 10.13 Power saving settings

### Why change the power saving features?

Standby Mode exists in the projector as a power-saving feature. If the projector is projecting no image, it will automatically go to Ready and standby mode after 15 minutes each. While in standby mode, it is no longer possible to use the OSD for anything other than a status overview.

Power saving features comes at the cost of disabling projection functionality. Depending on your specific installation, you may either want to:

- increase the power-saving features to an absolute maximum (e.g. using the Standby ECO mode and reducing time-out to an absolute minimum)
- reduce the power-saving features to allow technicians to modify the projector for as long as needed, or
- disable the power saving features all together.

### Available power modes

- **Ready:** Disables Standby mode all together. Uses the most power, but keeps most of the projector functionality available.
- **Standby mode:** After a set time-out, the projector disables most functionality to save power, safe the communication options. This allows the projector to be awoken either using the local keypad, the RCU or remotely using Projector Toolset, DMX or other automation controllers.
- **Standby ECO mode:** After a set time-out, the projector disables almost all functionality to save power, safe a single small wake-up controller. This allows the projector to be awoken **only** using the local keypad or the RCU. The projector can not be awoken remotely using this method.

### How to change the power saving feature?

1. In the main menu, select *Settings* → *Power settings*.



Image 10-46 Settings menu, Standby mode

The *Standby mode* menu is displayed.

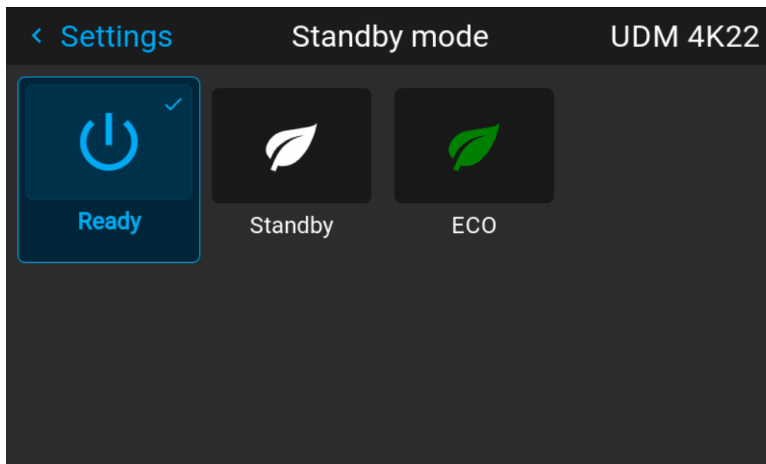

Image 10–47 Example of the Standby mode menu

2. Select the desired standby mode feature, or disable it by choosing *Ready*.

### How to change the chosen standby time-out?

1. In the main menu, select *Settings* → *Power settings*.



Image 10–48 Settings menu, Power settings

The *Power settings* menu is displayed.

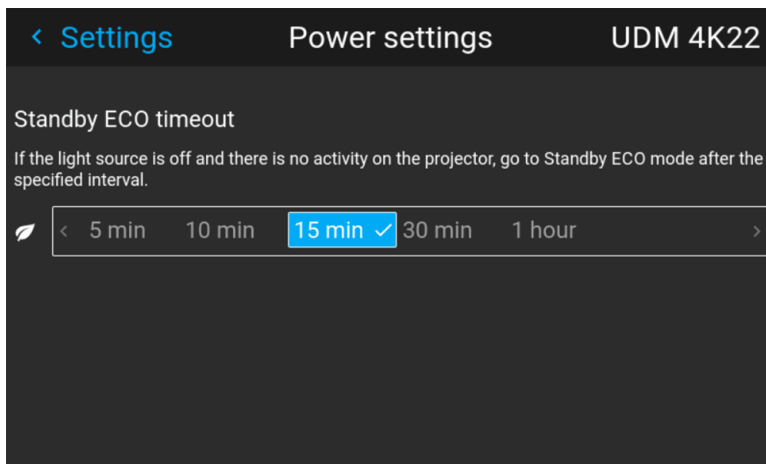

Image 10–49 Example of the Power settings menu, here with ECO standby mode active

2. Select the desired standby time-out timeframe.

## 10.14 Lens features

### What can be done?

Some lens features can be disabled once they are correctly aligned so that a misalignment during a show is not possible.

## How to enable/disable

1. In the main menu, select *System Settings* → *Lens Features*.



Image 10–50 Settings menu, Lens features

The Lens features menu is displayed.

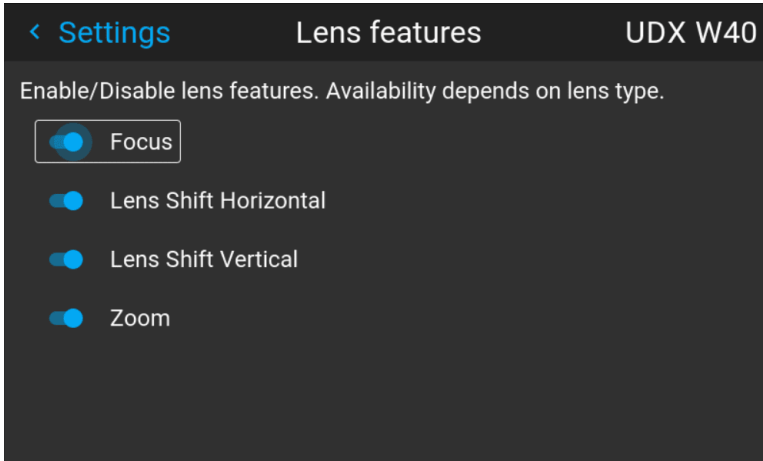

Image 10–51 Example of the lens features menu

Depending on the mounted lens type, different functions may or may not be available such as:

- Focus
  - Horizontal lens shift
  - Vertical lens shift
  - Zoom
2. To enable/disable a feature, click on the slider and drag it to the left to disable the feature or the right to enable the feature.

When enabled, the slider becomes blue; when disabled, the slider is gray.

## 10.15 Factory reset

### What can be done?

All settings and values on the projector can be reset to its default values. This can be done for one or more settings separately, or all settings together (factory reset).

### Factory settings

The following settings are the default factory settings:



All Factory settings are listed, regardless of the projector type or chosen projector options. If an option in this list is not present in your menu, the feature is not available or enabled on your projector.

Option / Domain	Setting	Factory setting
DMX	DMX Mode	Basic
	Start Channel	1



Option / Domain	Setting	Factory setting
	Auto power down Art-net XLR Connector	Disabled
GSM	PIN State	Unconfirmed
Illumination	Power	100%
	Constant light output (CLO)	Disabled
ImageActuator	4K Actuator enabled / disabled	Enabled
Blend	Blend / Mask size Black Level	Disabled, all value to zero
	Black Level Files Blend Files	Disabled. <b>Note:</b> All uploaded blend and black level files will be deleted
ImageCapture	Camera	Camera disabled, all measurements reset to 0
Connectors	Signal range	Auto
	Color space	Auto
	EDID	Default EDID for projector type <b>Note:</b> All uploaded custom EDID files will be deleted.
Convergence	Electronic Convergence	All values to zero
Display	Display mode	AutoStereo
Image features	Contrast	mid value
	Brightness	mid value
	Saturation	mid value
	Sharpness	mid value
	Gamma	mid value, auto
	Digital Shift and Zoom	Disabled, set to mid values
	Cropping	Off
	Aspect Ratio	16:9
	Scaling	Fill Aspect ratio
Orientation	Orientation	Table, Front
RealColor™ P7	P7 Realcolor™	all set to native
Resolution	Output Resolution	4K UHD (4K devices) WQXGA (W devices) WUXGA (U devices)
Source	Source files	Standard
3D	Sync delay	0 µs
	Swap eye	Off
	Dark time	lowest value available
Test patterns	Test Pattern	Off, none selected,

Option / Domain	Setting	Factory setting
		<b>Note:</b> All uploaded custom test patterns will be deleted
Uniformity	DynaBlack	Off
Warp	Screen size	5120x3200 / 2560x1600
	4 corner Bow	Warp disabled, no warp
	Warp files	Disabled <b>Note:</b> all uploaded warp files will be deleted
Network	Communication	LAN, Automatic settings
Optics	High Contrast	Off
Peripheral	Settings for External Cooler	Cooling mode set to internal.
	Settings for Motorized Frame	All values to mid value
Profiles	Settings for projector profiles	All profiles will be deleted
Screen	Screen luminance unit	nits
	Screen Luminance	400
	HDR Boost	1.0
System	Auto off / Eco Mode / Standby Mode (depending on availability)	Enabled
	Ready Time-out	auto
	Operational Mode	Normal
Time	Time server	Automatic disabled, NTP server removed
	Date	0 / 0 / 0
	Time	0 : 0 : 0
	Region / City	UTC
User	User profiles	Only default users remain
	Capture mode	Disabled
User interface	Theme	Dark
	Units – Temperature	°C
	Units – Length	Meters (m)
	Language	English
	Backlight – Stealth Mode Backlight – Timeout	Off 5 minutes

### How to reset all projector settings

1. In the main menu, select *Settings* → *Maintenance* → *Reset*.



Image 10–52 Settings menu, factory reset

The Reset menu is displayed.

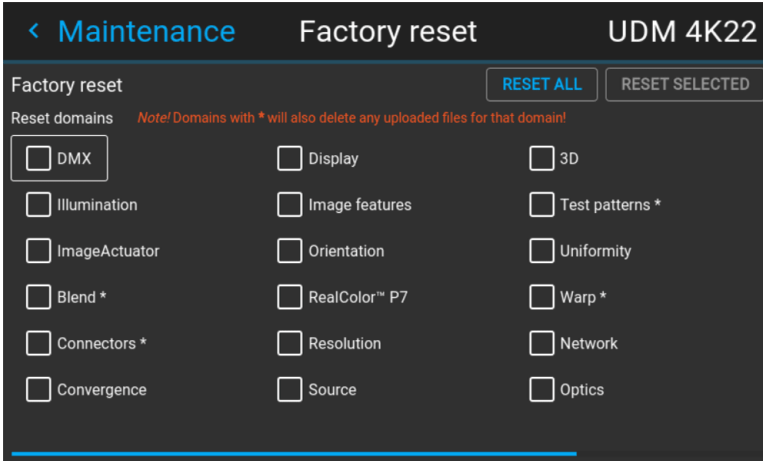

Image 10–53 Example of the reset menu

2. In the Reset menu, select *RESET ALL* and confirm with **OK**.

### How to reset one or more projector settings

1. In the main menu, select *Settings* → *Maintenance* → *Reset*.

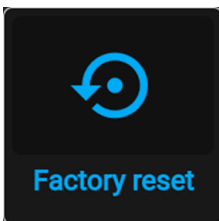

Image 10–54 Settings menu, factory reset

The Reset menu is displayed.

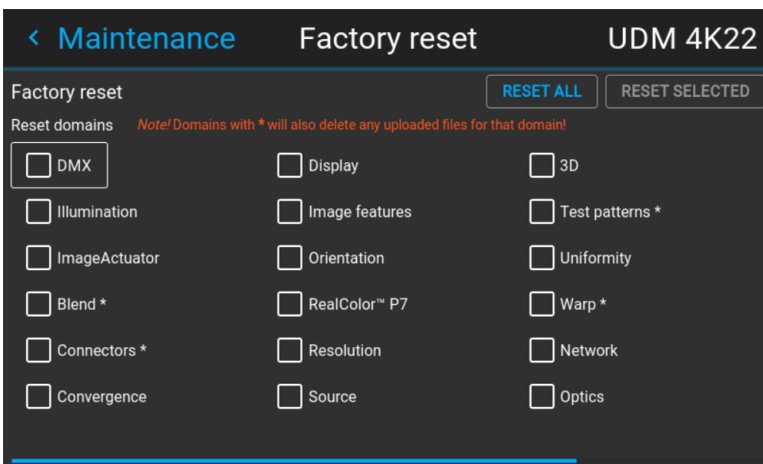

Image 10–55 Example of the reset menu

2. Navigate to the checkbox next to the settings that need to be reset and press **OK**.

Multiple selections are possible.

3. Select **RESET SELECTED** and confirm with **OK** to reset all selected settings.

## 10.16 Lens Calibration

### How to calibrate

1. In the main menu, *Settings* → *Maintenance* → *Lens Calibration*.



Image 10–56 Maintenance menu, lens calibration

The Lens Calibration menu is displayed, alongside the status of each

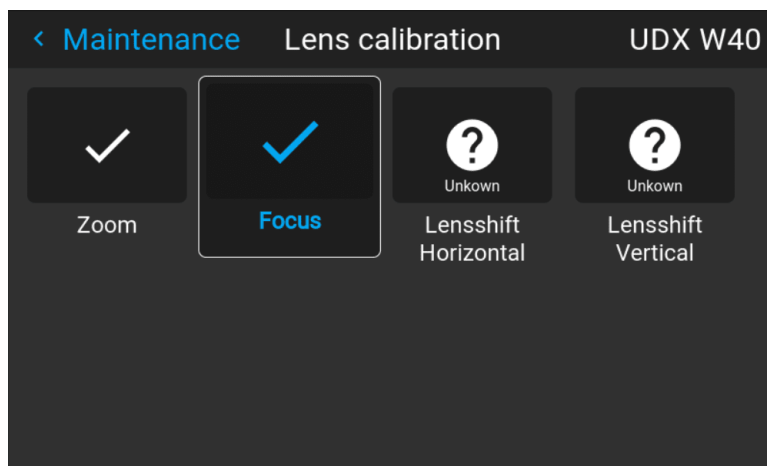

Image 10–57 Example of the lens calibration menu

2. In the Lens Calibration menu, select the desired calibration action and click **OK**.  
You can select one of the following functions, depending on the type of mounted lens:

- Horizontal lens shift
- Vertical lens shift
- Focus
- Zoom

The text **Calibrating** will be displayed in the icon of the selected function until the calibration is completed.

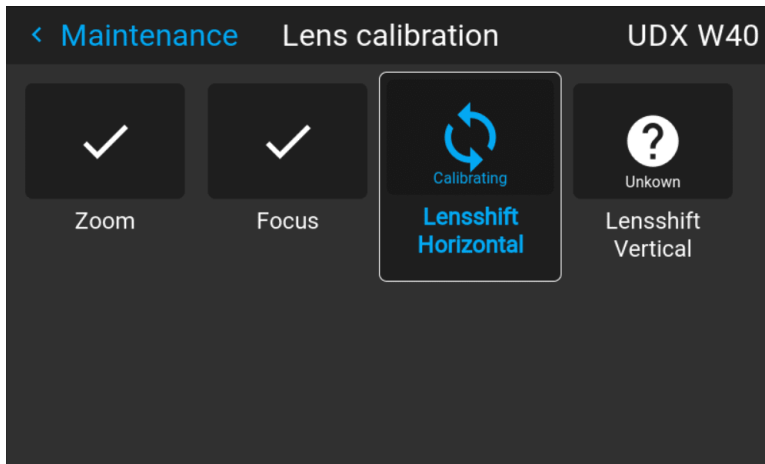

Image 10–58 example of calibration in progress

When an error is detected, the message *Calibration Error* is displayed next to function.

## 10.17 Flex brightness



This feature is available by default on the following devices: UDM 4k22, UDM W22.  
This feature is also available as an option on the following devices: UDM 4K15, UDM W19, UDM W15.

### Overview

With the FLEX technology the projector owners can lock the light output to different levels. The locking can be done via 3 different ways:

- Via Projector Toolset when connected via an ethernet connection with the projector. For more information on how to set up and use the Flex license, see the Projector Toolset's user guide, chapter *“Configuration, License / registration”*.
- Via Barco Insights Management Suite when the GSM module is installed. For more information on how to set up and use the Flex license, see Projector Management Suite user guide, chapter “Projector Configuration tab” – “Flex brightness”
- Via the OSD menu of the projector itself

To lock to a specific value a 4 digit code is necessary. These codes can be created by the projector owner using Projector Toolset or the Projector Management Suite.

### Availability

The flex brightness function is license protected. This license is already available in the projector. To activate the flex brightness a flex code is necessary. This flex code can be requested for free and uploaded via Projector Toolset or the Projector Management Suite. For more information about uploading this flex code, see Projector Toolset's user guide, chapter *“FLEX, light output control”*.

For other models, Flex brightness is an option. You can order and buy a license file. This license file is linked with the projector type and projector serial number. Once you received you license file, upload this file via Projector Toolset to your projector. Once the file is uploaded, the same file has to be used to upload the Flex code.

### Flex codes

Once your flex code is correctly uploaded, the projector creates a number of flex codes, one for each possible maximum light output. These codes are used for rental activities when adapting the light output of the projector.

The created flex codes are only visible in Projector Toolset and the Projector Management Suite by the projector owner. To make these visible he will need his license for this typical projector.

## Maximum Light output setup via OSD menu

1. In the main menu, select *Settings* → *Maintenance* → *Flex*.

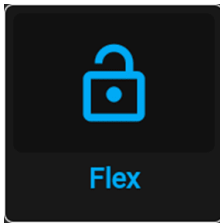

Image 10–59 Maintenance menu, Flex

The *Flex license* menu is displayed.

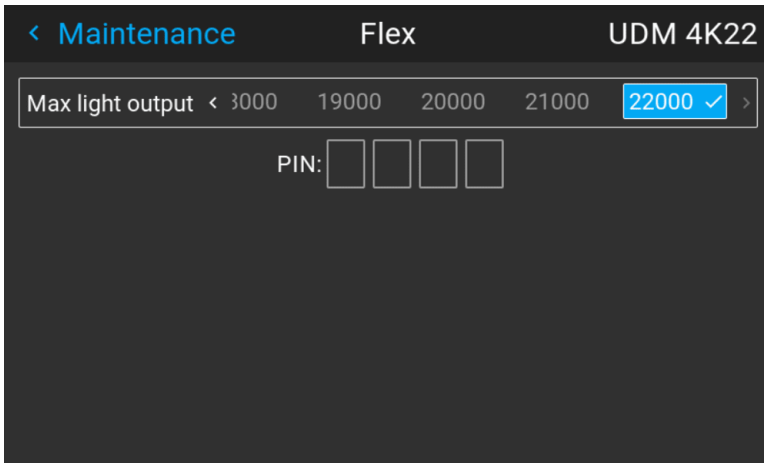

Image 10–60 Example of the Flex license menu

2. Choose the desired Light output (in lumens) for which you have a code available.
3. Enter the code via the OSD menu and confirm.

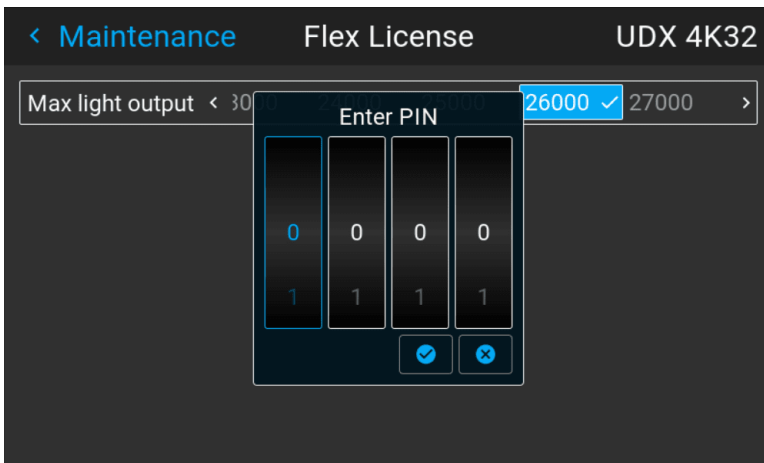

Image 10–61 Example of entering the code in the Flex license menu

## 10.18 Rigging frame Calibration

### How to calibrate the motorized rigging frame

1. In the main menu, select *Settings* → *Maintenance* → *Frame Calibration*.

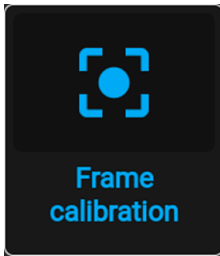

Image 10–62 Maintenance menu, Frame calibration

The Frame calibration menu is displayed.

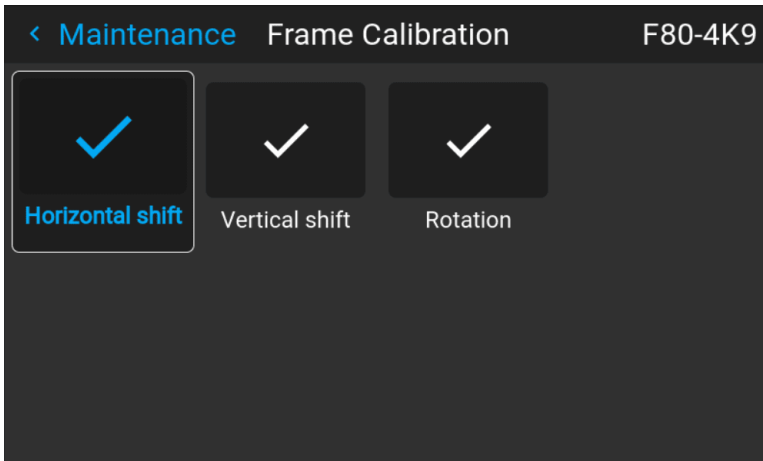

Image 10–63 Example of the Frame calibration menu

2. In the Frame Calibration menu, select the desired calibration action and click **OK**.

You can select one of the following functions:

- Horizontal shift
- Vertical shift
- Rotation

The text **Calibrating** will be displayed until the calibration is completed.



Image 10–64 Example of a calibration in progress

When an error is detected, the message *Calibration Error* is displayed next to function.

## 10.19 Electronic Convergence

### What can be done?

The convergence patterns can be used to check the convergence alignment of red, green and blue. If there is a misalignment of at least one 1 pixel, an electronic realignment is possible.

Mechanical realignment of the convergence can only be done by a qualified service technician.

### How to display the convergence settings

1. In the main menu, navigate to *Settings* → *Maintenance* → *Electronic Convergence*.

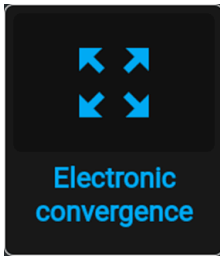

Image 10-65 Maintenance menu, electronic convergence

The Electronic Convergence menu is displayed.

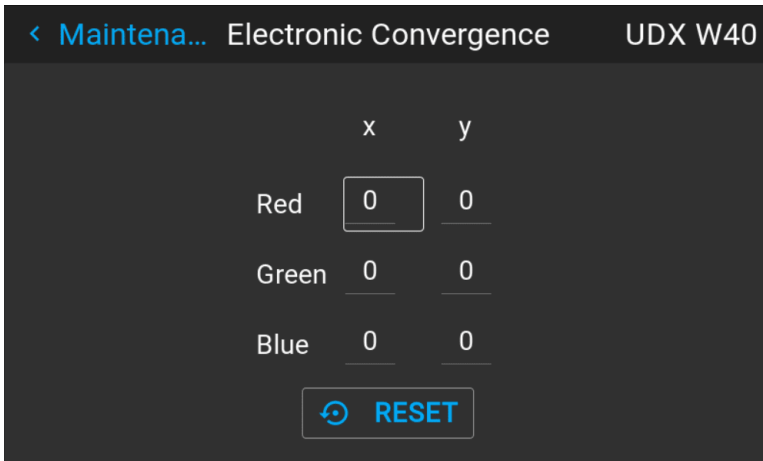

Image 10-66 Example of the electronic convergence menu

2. Select the desired X or Y value for one of the three colors and confirm.
3. Use the arrow keys to raise or lower the value and confirm.
4. Confirm all changes by pressing **Enter**.

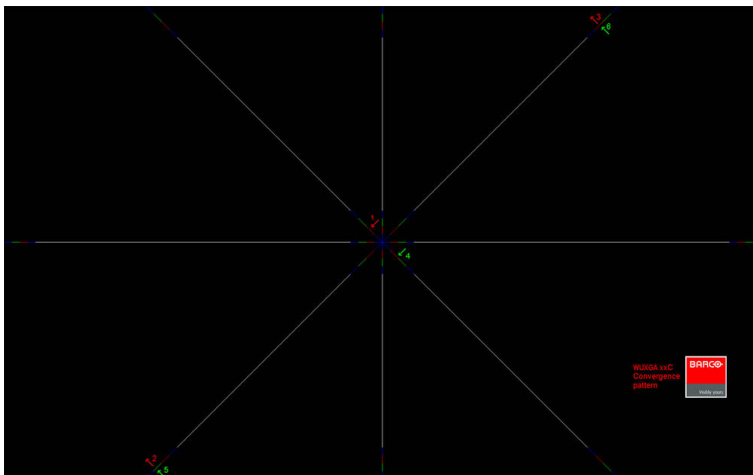

Image 10-67



*Tip:* Press **Reset** to return all values to the factory settings.

5. Repeat all steps until the desired alignment is achieved.



## 10.20 Operational mode

### Overview

The UDM range now offers you a possibility to choose the most relevant user mode for your application. You can select, setup and tweak the mode which you need, while a smart monitoring algorithm in the background keeps on balancing and optimizing between illumination output power, minimal noise level and optimized temperature household.

These are the presets being offered to start from:

1. “*Normal mode*”: This is the standard mode delivering highest possible brightness while ensuring a life time of 20 000 hours and keeping the noise level around 48 dBA.
2. “*Silent mode*”: controlling maximal fan speed staying 47 dBA.

### How to change the operational mode of your projector

1. In the main menu, navigate to *Settings* → *System* → Operational mode.

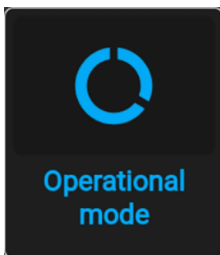

Image 10–68 Maintenance menu, operational mode

The Operational Mode menu is displayed.

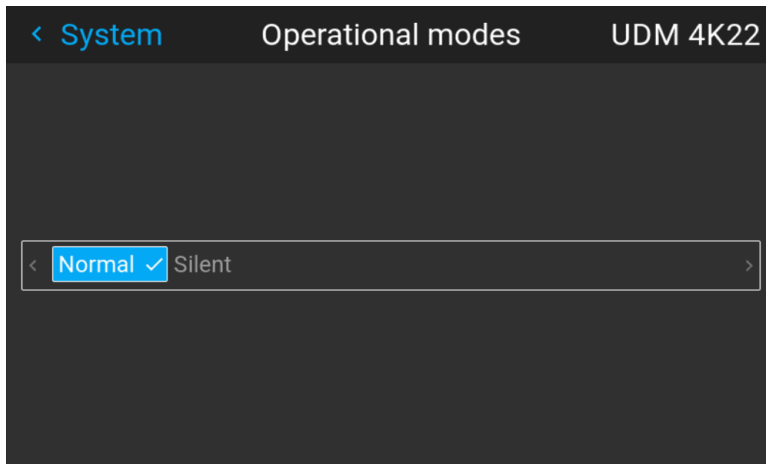

Image 10–69 Example of the Operational modes menu

2. Choose the desired operational mode.  
You may immediately notice a small difference, depending on the chosen operational mode.
3. Navigate to the Illumination menu and update the desired light output, depending on the chosen operational mode.



**Note:** If the light source cannot sustain the desired power, it will automatically be reduced to a power level that's sustainable for the light source and the chosen cooling power.

## 10.21 Capture mode

### Why use capture mode?

Various technical features are used inside the projector to display the best possible image on the projected surface. However, in expositions and setups where visitors are expected to film or take pictures of the projected surface, some of these technical features may have side-effects on the captured footage, such as solarization.

Enabling the Capture mode feature disables some of the technical features of the projector that are known to cause solarization and gives the visiting audience an experience they can “capture” and post on social media without worries.

### How to enable Capture mode

1. In the main menu, navigate to *Settings* → *System* .
2. In the Lens menu, click *Capture mode* to toggle between *On* and *Off*.

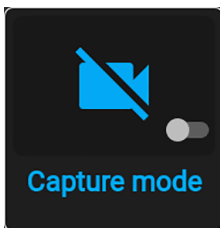

Image 10-70 System menu, Capture mode disabled

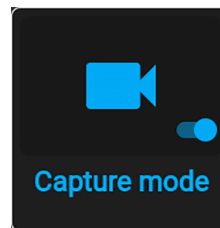

Image 10-71 System menu, Capture mode enabled

## 10.22 Login to advanced settings

### How to login

1. In the main menu, *Settings* → *Maintenance* → *Login*.

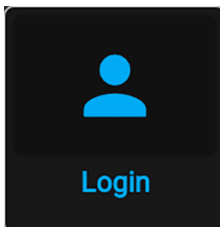

Image 10-72

The Login menu is displayed.

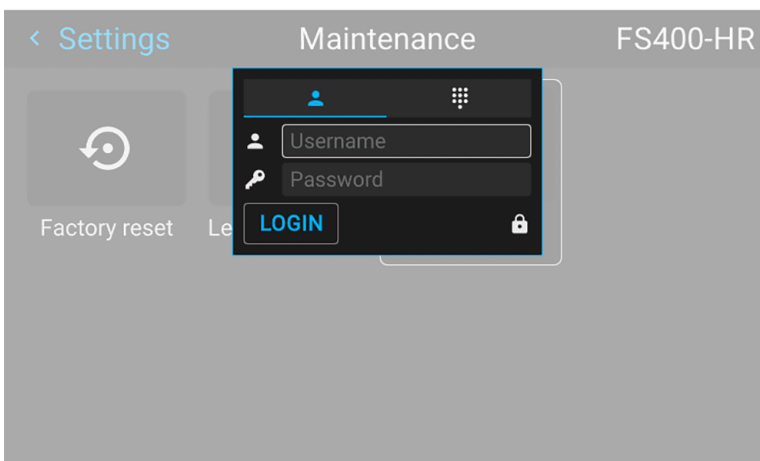

Image 10-73

There are 2 ways to login:

- Via user & password, go to step 2
- Via a digit code, go to step 5

**2.** To login via user & password, select *User* and click **OK**.

**3.** Navigate to *user name* and click **OK**.

A keyboard is displayed. Enter the user name

Navigate to Password and enter the password.

**4.** Select **LOGIN** and click **OK** to login.

**5.** To login via digit code, select digit keyboard and click **OK**.

**6.** Navigate to Pin code and click **OK**.

A keyboard is displayed. Enter the pin code.

## 10.23 List of open source licenses

### About open source licenses

Open source licenses are licenses that comply with the Open Source Definition. In brief, they allow software to be freely used, modified, and shared.

To be open and transparent about the open source software used on the projector, there is a list of all open source licenses available in the software.

### How to find the open source licenses

For the complete and most up-to-date list of the used open source software and the version used, go to the main menu and select *Settings* → *General* → *Open source licenses*.

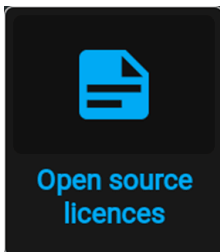

Image 10–74 General menu – Open source licenses



# Advanced Settings

# 11

11.1	Remote access – Enable source preview .....	158
11.2	Remote access – Enable camera preview .....	159
11.3	Advanced Settings – Color .....	160
11.4	Advanced Settings – Statistics .....	161
11.5	Checking the status of the Laser Banks .....	162
11.6	Advanced settings – Tilt sensor calibration .....	163

## About the Advanced Settings menu

The Advanced Settings and Remote access menus are hidden by default for the regular user. You can only make these menus visible after entering a *User name* and *Password* or a *Service code* with the remote control. See “[Login to advanced settings](#)”, page 154 for more info.

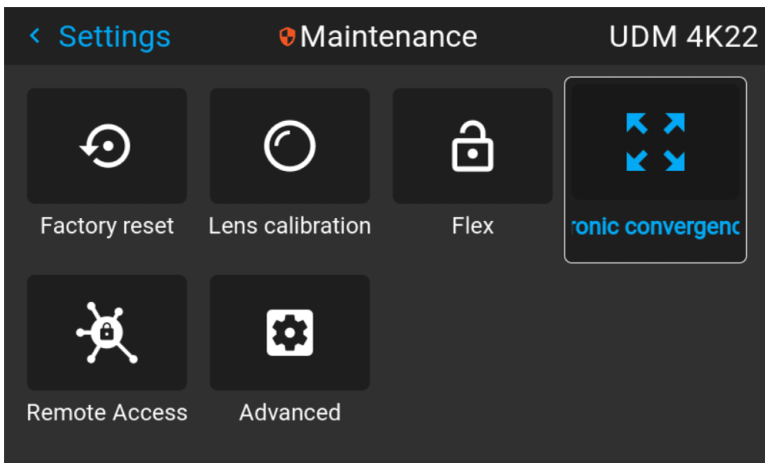

Image 11-1 Example of the Maintenance menu, with the Advanced menu and Remote access menu unlocked



The Advanced Settings and Remote access menu items will remain visible until you leave the Maintenance menu.

## 11.1 Remote access – Enable source preview

### Source preview

Up until Pulse software 2.0.x, you were able to see a preview of the connected source when you remotely accessed the projector. This was a feature you could disable using Projector Toolset.

However, from Pulse 2.1.x onward, this feature is disabled by default and can now be enabled in both Projector Toolset and the Pulse GUI.



Upgrading your projector from a software version 2.0.x or older to 2.1.x or newer will disable *Source preview* by default. Once the software has been successfully upgraded, you can always opt to enable this feature again.

### How to enable source preview

1. In the main menu, select *Settings* → *Maintenance* and login to visualize the hidden Remote access menu.
2. Select *Remote access*.

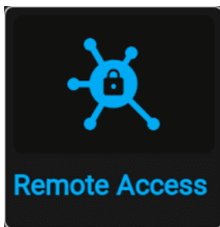

Image 11–2 Maintenance menu, Remote access

The *Remote access* menu is displayed.

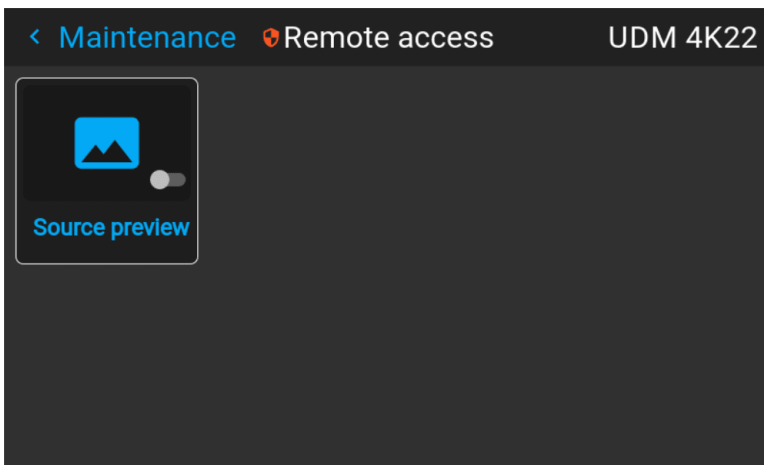

Image 11–3 Example of the Remote access menu

3. Enable the slider to enable the source preview feature.

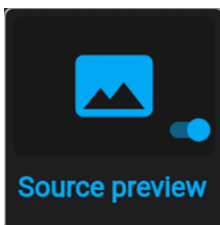

Image 11–4 Remote access menu, Source preview is enabled

## 11.2 Remote access – Enable camera preview

### Camera preview

Up until Pulse software 2.0.x, you were able to see the footage of the camera when you remotely accessed the projector. This was a feature you could disable using Projector Toolset.

However, from Pulse 2.1.x onward, this feature is disabled by default and can now be enabled in both Projector Toolset and the Pulse GUI.



Upgrading your projector from a software version 2.0.x or older to 2.1.x or newer will disable *Camera preview* by default. Once the software has been successfully upgraded, you can always opt to enable this feature again.

### How to enable Camera preview

1. In the main menu, select *Settings* → *Maintenance* and login to visualize the hidden Remote access menu.
2. Select *Remote access*.

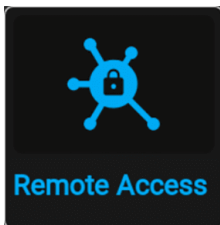

Image 11–5 Maintenance menu, Remote access

The *Remote access* menu is displayed.

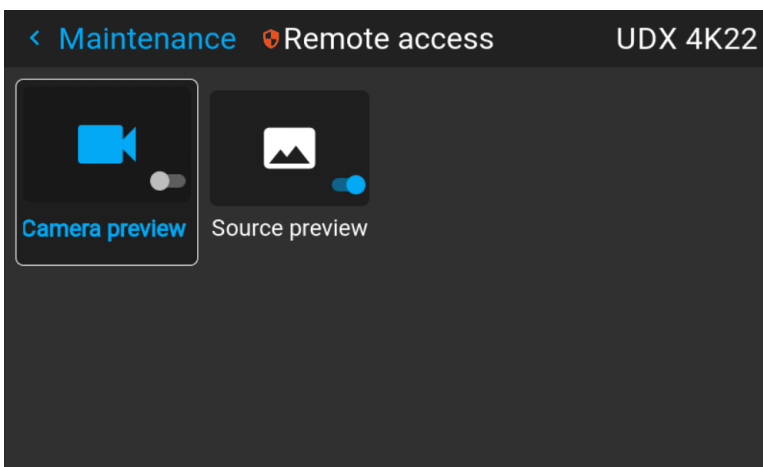

Image 11–6 Example of the Remote access menu

3. Enable the slider to enable the Camera preview feature.

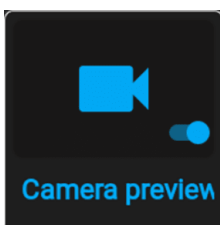

Image 11–7 Remote access menu, Camera preview is enabled

## 11.3 Advanced Settings – Color



**CAUTION:** The native colors have been measured and set during factory production. Do not change them, unless parts of the optical path have been replaced due to servicing. If you need to change the native colors on the device, make sure to also perform a **P7 calibration**, using the Projector Toolset and a chroma meter. For more info on P7 calibration, refer to the Projector Toolset Reference guide.

### How to adjust the P7 native settings

1. In the main menu, navigate to *Settings* → *Maintenance* → *Advanced*, while you are logged in.

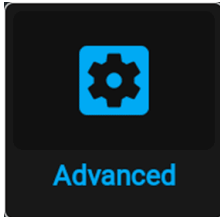

Image 11–8 Maintenance menu, Advanced

2. In the Advanced Settings menu, select *Native RealColor*.

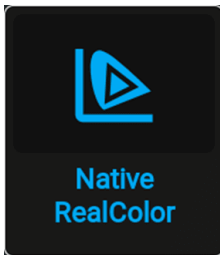

Image 11–9 Advanced Settings, Native Realcolor

The RealColor calibration menu will be displayed.

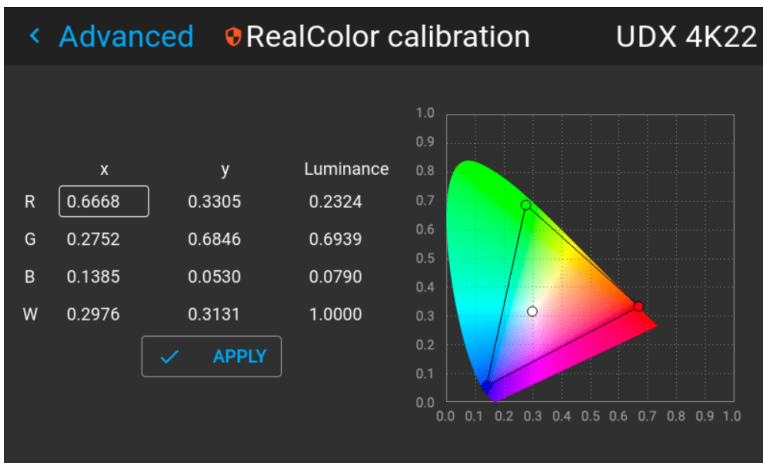

Image 11–10 Example of the RealColor calibration menu

3. Select the desired value to change and confirm.
4. Change the values to the desired position, taking into account the color gamut values.
5. Select **APPLY** and confirm.



## 11.4 Advanced Settings – Statistics

### What can be seen?

The statistics screen shows the general information about the projector, spread over two tab pages.

The following items will be displayed:

- Laser runtime
- Laser Strikes
- Laser bank x runtime
- Projector runtime
- System runtime
- System uptime

### How to display the statistics

1. In the main menu, navigate to *System Settings* → *Maintenance* → *Advanced Settings*, while you are logged in.

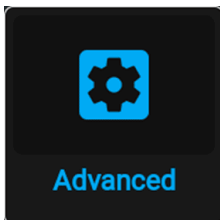

Image 11–11 Maintenance menu, Advanced

2. In the Advanced Settings menu, select *Statistics*.

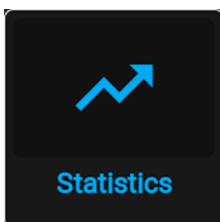

Image 11–12 Advanced settings, Statistics

The Statistics will be displayed.

 A screenshot of the "Light source statistics" screen for a UDX 4K32 projector. The screen shows a list of statistics with a blue vertical bar on the right side.
 

Light source statistics		UDX 4K32
Laser run time	510 hours	
Laser strikes	199	
Laser bank 1 run time	510 hours	
Laser bank 2 run time	510 hours	
Laser bank 3 run time	510 hours	
Laser bank 4 run time	510 hours	
Laser bank 5 run time	510 hours	
Laser bank 6 run time	510 hours	
Laser bank 7 run time	510 hours	
Laser bank 8 run time	510 hours	
Laser bank 9 run time	510 hours	
Laser bank 10 run time	510 hours	
Laser bank 11 run time	510 hours	

Image 11–13 Example of the Statistics menu

## 11.5 Checking the status of the Laser Banks

### About failing laser banks

The projector is powered by a laser light source, which has multiple laser banks. The light output and color performance is dependant on the number of active laser banks.

If one or more laser banks have failed of a certain type, you will notice a decreased light input and decrease in color performance. But the projector will keep on playing, unless too many banks of a certain color will have failed.



In order to disable a certain laser bank, or calibrate the projector after disabling one or more laser banks, please refer to the Projector Toolset User Manual.

### How to check the status of the Laser Banks

1. In the main menu, navigate to *Settings* → *Maintenance* → *Advanced*, while you are logged in.

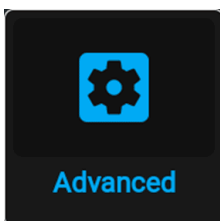

Image 11–14 Maintenance menu, Advanced

2. Enter the service code.
3. In the *Service* menu, select *Laser Banks*.

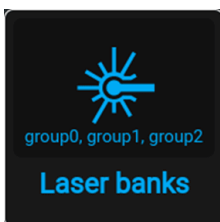

Image 11–15 Advanced menu, Laser banks

The Laser group statistics menu is displayed.

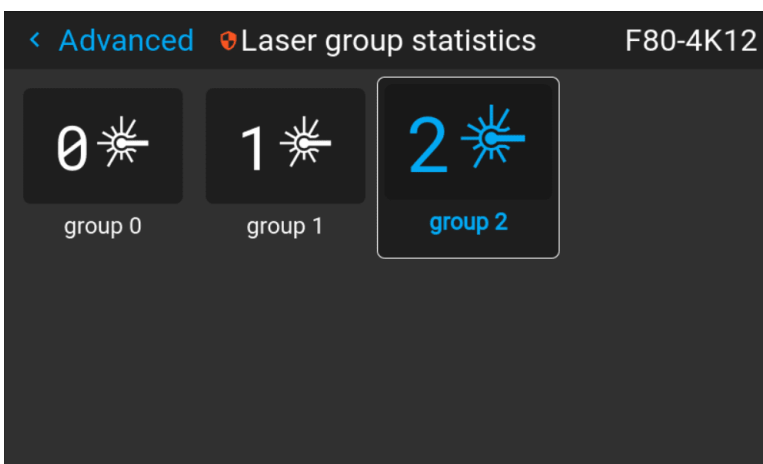

Image 11–16 Example of the Laser group statistics menu

4. Select the desired laser group.
5. In the laser banks group page, you can see which laser banks are part of this specific group. You can also see which laser banks are operational and which have failed.

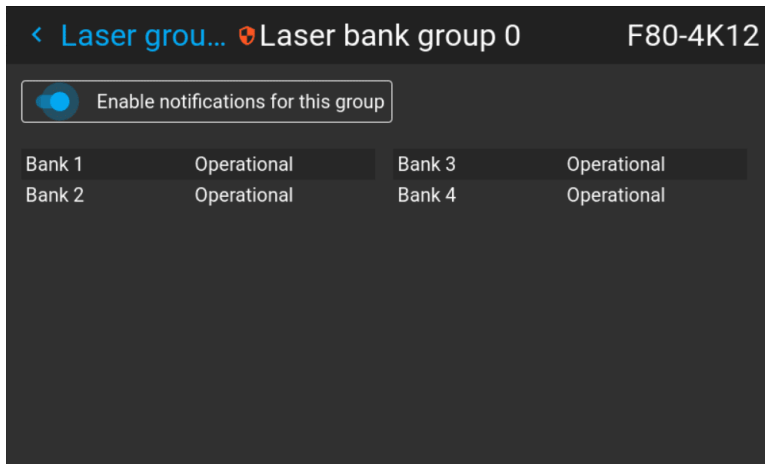

Image 11–17 Example of the laser bank group menu

- If you want notifications to be disabled for a specific group of laser banks, disable the *Enable notifications for this group* slider.

## 11.6 Advanced settings – Tilt sensor calibration



**CAUTION:** The calibration procedure resets the values of the tilt sensor to 0 in the current position of the projector. For the optimal working of the tilt sensor it is important to make sure the projector is perfectly level when performing this procedure. If not, the tilt sensor will not function as desired once the calibration has been completed.

### Required tools

Level

### How to calibrate the tilt sensor?

- Place the projector on a flat surface and make sure it is positioned level in all directions. Use a level tool to help ensure this.
- In the main menu, navigate to *Settings* → *Maintenance* → *Advanced*, while you are logged in.

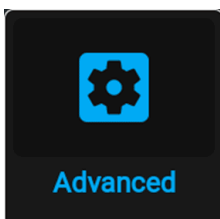

Image 11–18 Maintenance menu, Advanced

- Enter the service code.
- In the *Service* menu, select *Tilt sensor calibration*.



Image 11–19 Advanced menu, Tilt sensor calibration

- Confirm your action.

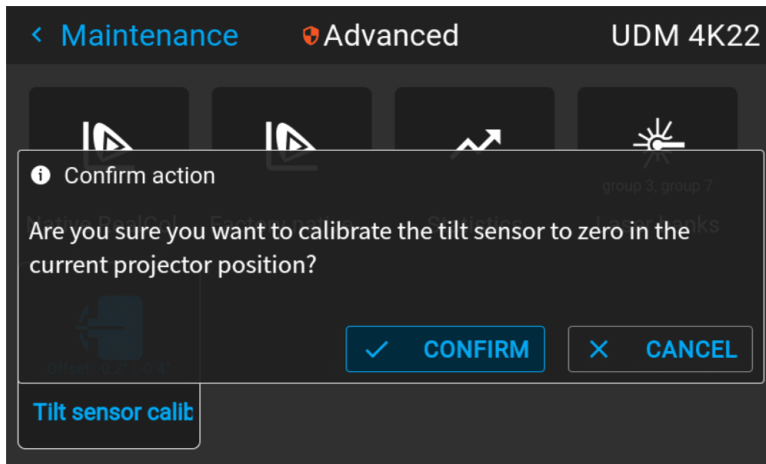

Image 11–20 Example of the Advanced menu with the Tilt sensor menu

The tilt sensor will be set to zero in the current position of the projector.

# GUI – Status menu

# 12

12.1 Status menu overview.....	166
--------------------------------	-----



No settings can be modified in the status menu. Its only for consulting.

## 12.1 Status menu overview

### How to access the status menu

While in the main menu, press Status.

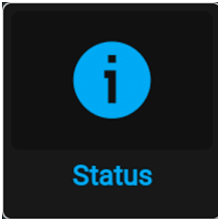

Image 12–1 Main menu, status

The status menu is displayed.

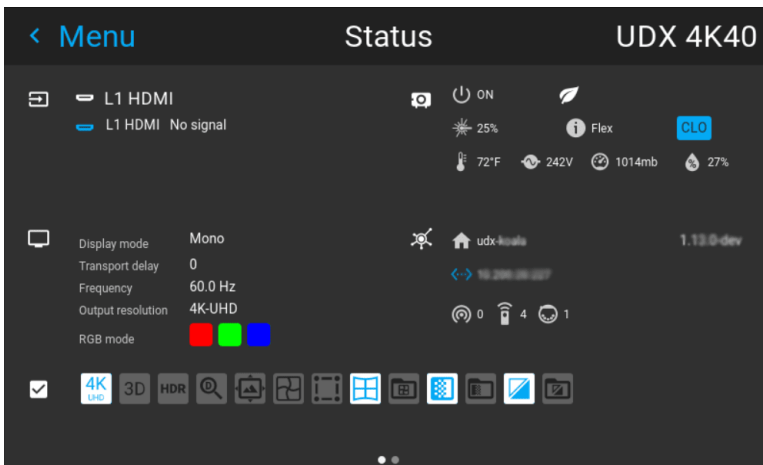

Image 12–2 Example of the first page of the status menu

Swipe the screen left of right to swap between the Status pages.

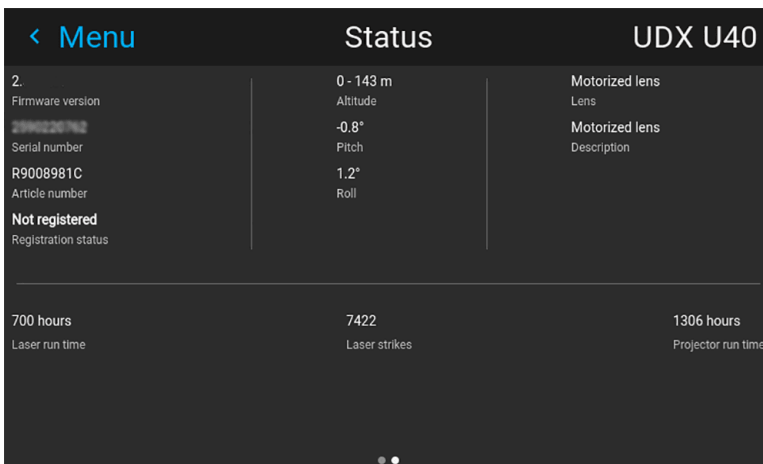

Image 12–3 Example of the second page of the Status menu

### What can be seen on the Status page?

- Connected source and signal details
- Display settings (e.g. display mode, transport delay, output resolution, etc)
- Projector power and environmental details (e.g. power, temperature, pressure, etc)
- Network status (e.g. host name, IP address, software version)
- Active function icons (e.g. warp, blend, files, etc). Active functions are highlighted, while inactive functions are muted.

## What can be seen on the About page?

- Projector information, e.g. firmware version, serial number, projector article number and registration status (only if applicable for your device)
- Mounted lens: Lens type and Lens description (if available).
- Installation information: Altitude, pitch angle, roll angle, distance (only if applicable for your device)
- Basic statistics, Light source run time, light source strikes, projector runtime.





# Product maintenance

# 13

13.1	Software update .....	170
13.2	Cleaning the lens .....	171
13.3	Cleaning the exterior of the projector .....	172
13.4	Cleaning / replace the air filters .....	172

## About this chapter

This chapter contains general maintenance procedures.

## 13.1 Software update



**CAUTION:** Do not power off or unplug the projector while the software update is ongoing.

### How to update the software

1. Power on the projector. Wait until the **Power on/off** button is lit white or blue.
2. Download and install the latest version of Projector Toolset for Pulse. The program can be downloaded for free from Barco's website, (URL: <http://www.barco.com>). Click on *myBarco* and log in to get access to secured information. Registration is necessary.

If you are not yet registered, click on *New to myBarco* and follow the instructions. With the created login and password, it is possible to log in where you can download the software.

3. Download the latest firmware (format .fw) from Barco's website in the same way as for Projector Toolset.
4. Start Projector Toolset and make a connection with the projector. For more information, see the “*Projector Toolset*” user guide.
5. Select tab **Update settings**.
6. Fill out the path to the update file (1)

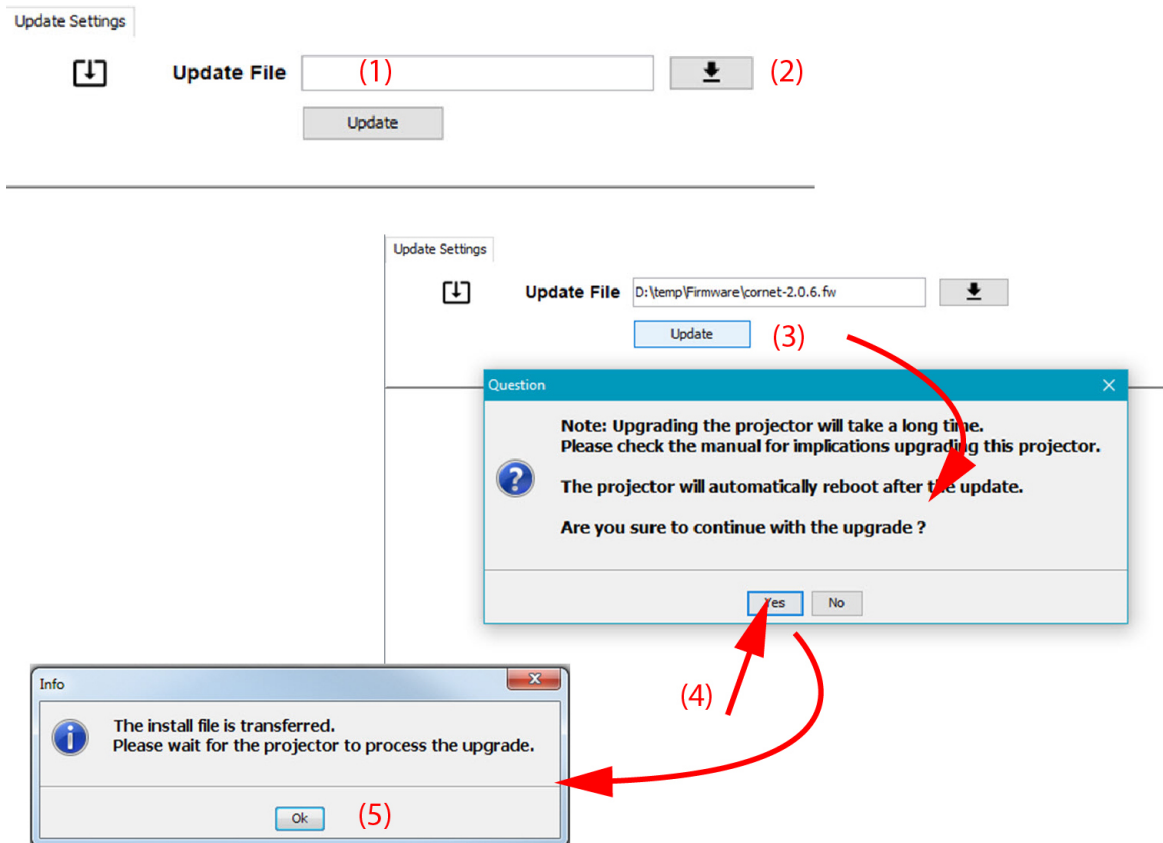

Image 13–1 Update Pulse projector

or

click on the path selection icon (2) to open a browser window.

7. Browse to the desired update package (format .fw) and click **Select Update Package**.

The path will be filled out in the input field next to *Update File*.

8. Click **Update** (3).

The update starts. This action can take a long time. A message is displayed.

- Click **Yes** to continue (4).

The update file will be transferred to the projector and installed. The projector will reboot.

A message is displayed. Click **Ok** to clear the message.

## How to update the software if the projector isn't connected to the network

- Power on the projector. Wait until the **Power on/off** button is either lit white or blue.
- Download the latest firmware file (format .fw) from Barco's website. The firmware can be downloaded for free from Barco's website, (URL: <http://www.barco.com>). Click on *myBarco* and log in to get access to secured information. Registration is necessary.

If you are not yet registered, click on *New to myBarco* and follow the instructions. With the created login and password, it is possible to log in where you can download the software.

- Place the firmware file on a clean USB flash drive.



*Note:* Make sure the flash drive is FAT32 compatible & no other files are on the flash drive.

- Plug the flash drive in the USB port on the Communication Panel.

The update file will be transferred to the projector and installed. The projector will reboot when completed.



**CAUTION:** While it is technically possible to “downgrade” the software to an older version using this method, it is **NOT** recommended and should be avoided as much as possible. Certain features will no longer be supported, projectors can display unwanted behavior during the downgrade and in some rare cases, this may even bring damage to the device. Always contact Barco if you want to make sure a downgrade will not hurt your device.



Take note that the update process can take a long time to complete.



For more info about the Projector Toolset see user guide of the Projector Toolset.

## 13.2 Cleaning the lens



To minimize the possibility of damage to optical coatings, or scratches to lens surfaces follow the cleaning procedure as described here precisely.

### Required tools

- Compressed air
- Clean micro fiber lens cleaning cloth (e.g. Toraysee® cloth(s))
- Clean cotton cloth
- Lens cleaner (e.g. ZEISS lens cleaner, Purosol™ or other water based lens cleaner products)

### How to clean the lens?

- Blow off dust with clean compressed air (or pressurized air cans<sup>6</sup>).
- Clean with lens cleaner together with a clean lens cleaning cloth to remove the dust and contamination. Use big wipes in one single direction.



**Warning:** Do not wipe back and forwards across the lens surface as this tends to grind dirt into the coating.

- Use a dry lens cleaning cloth to remove left liquid or stripes. Polish with small circles.

<sup>6</sup> Pressurized air cans are not efficient if there is too much dust on the surface, the pressure is too low

4. If there are still fingerprints on the surface, wipe them off with lens cleaner together with a clean lens cleaning cloth. Polish again with a dry one.



If smears occur when cleaning lenses, replace the cloth. Smears are the first indication of a dirty cloth.

## 13.3 Cleaning the exterior of the projector

### How to clean the exterior of the projector ?

1. Switch off the projector and unplug the projector from the mains power net.
2. Clean the housing of the projector with a damp cloth. Stubborn stains may be removed with a cloth lightly dampened with a mild detergent solution.

## 13.4 Cleaning / replace the air filters

### About the air filters

There are three air filters in the projector; at the front, at the top and on the right side of the projector. It is no regular interval for cleaning or replace the filters, but they must be inspected regularly to avoid clogging, and by that also a possibility of increased temperature internally in the projector.

### Cleaning of the filters

The top-, and side filter can be rinsed with lukewarm water and dried.

The filter in the front can be vacuum cleaned.

### About the cover locks

All the covers are fastened to the projector by “easylock” tabs. The procedure below shows the technique for releasing and locking of the tabs.

### Required tools

Flat screwdriver 5mm

### Unlocking the covers

1. Push down the inner side of the easylock with a screwdriver.

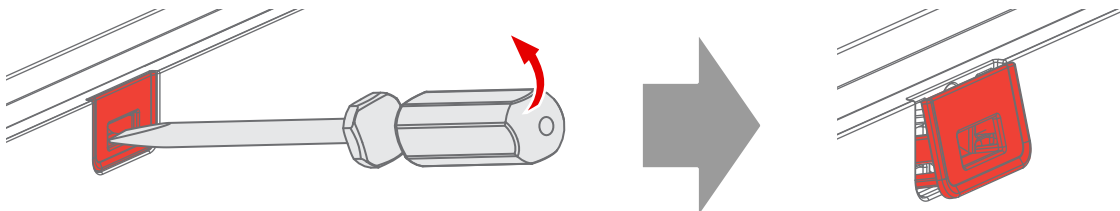

Image 13-2

As a result the lock jumps loose.

### Locking the covers

1. Ensure that the cover is in the correct position.
2. Press the easylock into the housing.

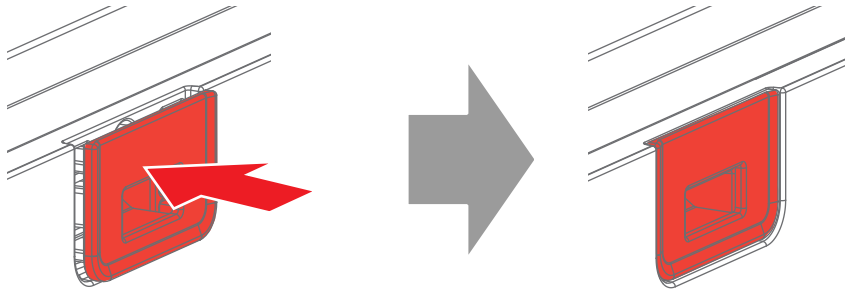

Image 13-3



If the top cover do not have “easylocks” for the filter cover (older UDM models), the filter must be serviced by authorized Barco personnel.  
The filter also can be vacuum cleaned from the outside, with less cleaning efficiency.

## Removing the top filter

1. Unlock the “easylock”, and flip the filter cover up.

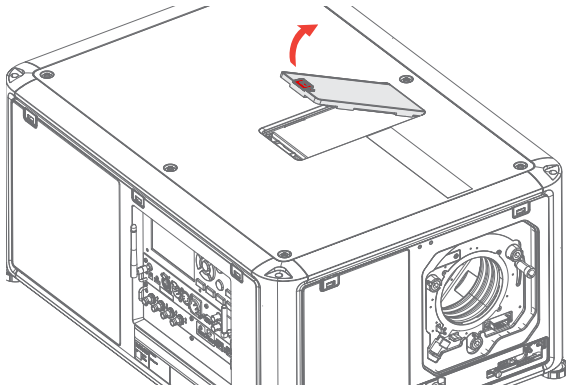

Image 13-4

2. Remove the filter from the projector.

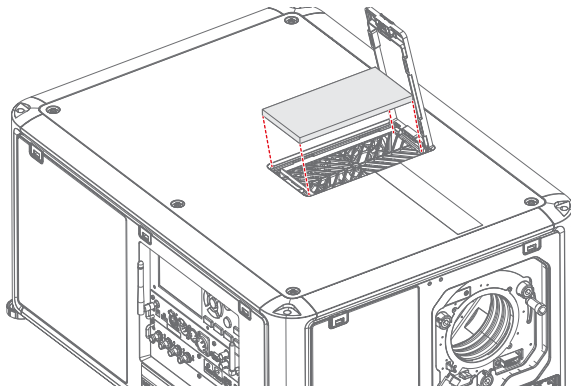

Image 13-5

3. Clean the filter with lukewarm water, and let it dry.
4. Insert the filter, and close and lock the filter cover.

## Removing the right side filter

1. Unlock the “easylocks”, and remove the right side cover.

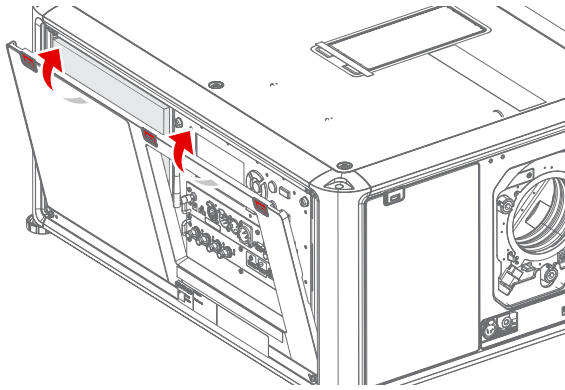

Image 13-6

2. Remove the filter from the projector.

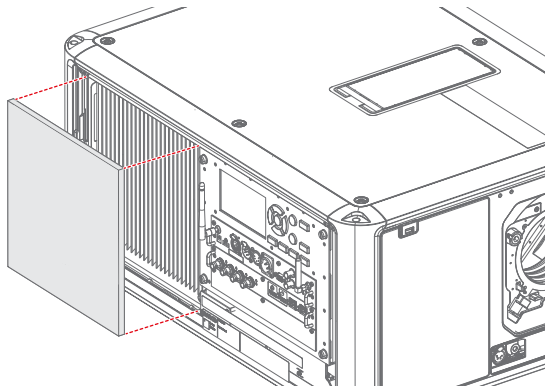



Image 13-7

3. Clean the filter with lukewarm water, and let dry.
4. Reinstall the filter in to the correct position.
5. Reinstall the side cover in the correct position, and press the “easylock”s

 *Note:* Ensure that the cover is in correct position, and correctly locked to the projector.

## Removing the front filter

1. Unlock the “easylocks”, and remove the front cover.

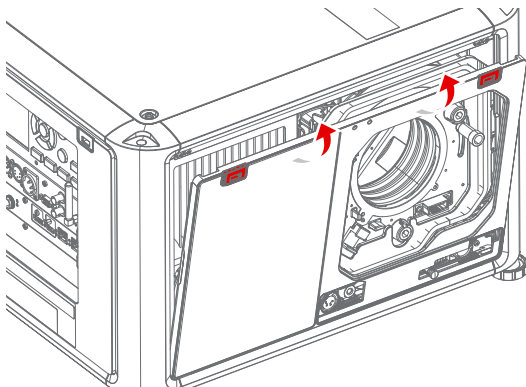

Image 13-8

2. Remove the filter from the front cover.

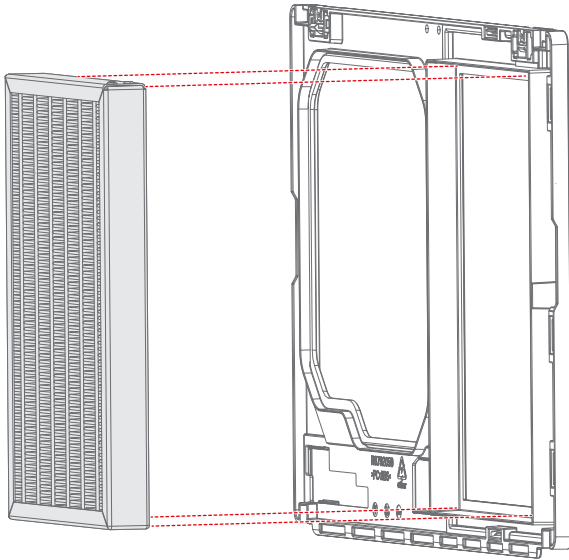

Image 13-9

3. Vacuum clean the filter.
4. Reinstall the filter in the front cover.
5. Reinstall the front cover in the correct position, and press the “easylock”s



*Note:* Ensure that the cover is in correct position, and correctly locked to the projector.





# Specifications

# A

A.1	Specifications SDI inputs.....	178
A.2	Specifications HDMI inputs.....	178
A.3	Specifications HDBaseT inputs.....	179
A.4	Specifications DisplayPort 1.2 inputs.....	180
A.5	Specifications SFP inputs.....	181

## About this chapter

This chapter gives an overview of the projector specifications

## A.1 Specifications SDI inputs



For readability, the video timings listed are summarized. For the full list of video timings, refer to the appendices.



HD-SDI follows the SMPTE 292M standard.  
3G SDI follows the SMPTE 425M standard Level A.  
12G-SDI<sup>7</sup> follows the SMPTE ST-2082-1 and ST-2082-10 standards.

### SDI specifications

Specification	Value		
Color space	YCbCr		
Color depth	10 bpc		
Chroma sampling	4:2:2		
Audio	not supported		
For future release	<ul style="list-style-type: none"> <li>• 3D support</li> <li>• Interlaced support</li> <li>• Segmented frame support</li> </ul>		
Video timings progressive <sup>8</sup>	Type	Port type	Format
	HD-SDI	Single link	<ul style="list-style-type: none"> <li>• Up to 1920 x 1080 @24 Hz</li> <li>• Up to 1920 x 1080 @25 Hz</li> <li>• Up to 1920 x 1080 @30 Hz</li> <li>• Up to 1280 x 720 @50 Hz</li> <li>• Up to 1280 x 720 @60 Hz</li> </ul>
		Quad link	
	3G-SDI Level A <sup>9</sup>	Single link	Up to 2048 x 1080 @50 Hz Up to 2048 x 1080 @60 Hz
		Quad link	
3G-SDI “BarcoLink”	Single link Quad link	1920 x 1200 @50 Hz, @59.94 Hz and @60 Hz	
12G-SDI (Channel A only)	Single link	3840 x 2160 @50 Hz and @60 Hz 4096 x 2160 @50 Hz and @60 Hz	
12G-SDI “BarcoLink 4k” (Channel A only)	Single link	3840 x 2400 @50 Hz, @59.94 Hz and @60 Hz.	

## A.2 Specifications HDMI inputs



For readability, the video timings listed are summarized. For the full list of video timings, refer to the appendices.

### HDMI specifications

Specification	Value
Pixel rate	25 – 600 MHz pixel clock
HDCP support	<ul style="list-style-type: none"> <li>• HDCP 1.x</li> </ul>

7. Quad Combo Input Mk II only.

8. For the full list of video timings, see Appendix user guide

9. Quad Combo Input Mk I only.

Specification	Value
	<ul style="list-style-type: none"> <li>• HDCP 2.2</li> <li>• RGB 4:4:4</li> </ul>
<b>Color space</b>	<ul style="list-style-type: none"> <li>• YCbCr 4:2:0</li> <li>• YCbCr 4:2:2</li> <li>• YCbCr 4:4:4</li> <li>• RGB 4:4:4</li> </ul>
<b>Color depth</b>	<ul style="list-style-type: none"> <li>• 24 bpp</li> <li>• 30 bpp</li> <li>• 36 bpp</li> </ul>
<b>3D support</b>	<ul style="list-style-type: none"> <li>• Field sequential 3D (Active 3D) <ul style="list-style-type: none"> <li>- Frame-packed</li> <li>- Top Bottom progressive</li> <li>- Side-by-side progressive</li> </ul> </li> <li>• Passive 3D <b>not</b> supported.</li> </ul>
<b>For future release</b>	<ul style="list-style-type: none"> <li>• Interlaced support</li> </ul>
<b>Audio</b>	Not supported
<b>Video timings<sup>8</sup></b>	<ul style="list-style-type: none"> <li>• Up to 4096 x 2160 @24 Hz</li> <li>• Up to 4096 x 2160 @25 Hz</li> <li>• Up to 4096 x 2160 @30 Hz</li> <li>• Up to 2048 x 1080 @48 Hz</li> <li>• Up to 4096 x 2160 @50 Hz</li> <li>• Up to 4096 x 2160 @60 Hz</li> </ul>
<b>Native video timings</b>	<ul style="list-style-type: none"> <li>• UDM-W: 1920 x 1200 @60 Hz</li> <li>• UDM-4K: 3840 x 2400 @60 Hz</li> </ul>

## A.3 Specifications HDBaseT inputs



For readability, the video timings listed are summarized. For the full list of video timings, refer to the appendices.

### HDBase T specifications

Specification	Value
<b>Pixel rate</b>	25 – 297 MHz pixel clock
<b>Color space</b>	<ul style="list-style-type: none"> <li>• YCbCr 4:2:2</li> <li>• YCbCr 4:4:4</li> <li>• RGB 4:4:4</li> </ul>
<b>Color depth</b>	<ul style="list-style-type: none"> <li>• 24 bpp</li> <li>• 30 bpp</li> <li>• 36 bpp</li> </ul>
<b>HDCP support</b>	HDCP 1.x supported on HDBaseT Input 1
<b>Network support</b>	Yes, on HDBaseT Input 1
<b>For future release</b>	<ul style="list-style-type: none"> <li>• 3D support</li> <li>• Interlaced support</li> </ul>
<b>Not supported</b>	<ul style="list-style-type: none"> <li>• Audio</li> <li>• Power over HDBaseT</li> </ul>

Specification	Value	
Video timings progressive <sup>8</sup>	Layout mode	Supported formats
	Standard layout (1x1 layout)	<ul style="list-style-type: none"> <li>Up to 4096 x 2160 @24 Hz</li> <li>Up to 4096 x 2160 @25 Hz</li> <li>Up to 4096 x 2160 @30 Hz</li> <li>Up to 2048 x 1080 @48 Hz</li> <li>Up to 2560 x 1600 @50 Hz</li> <li>Up to 2560 x 1600 @60 Hz</li> </ul>
	2 Column mode (2x1 layout)	<ul style="list-style-type: none"> <li>1920 x 2160 @50 Hz</li> <li>1920 x 2160 @60 Hz</li> <li>2048 x 2160 @50 Hz</li> <li>2048 x 2400 @60 Hz</li> </ul>
Native video timings	<ul style="list-style-type: none"> <li>UDM-W: 1920 x 1200 @60 Hz</li> <li>UDM-4K: 3840 x 2160 @60 Hz</li> </ul>	



**CAUTION:** The HDBaseT inputs can bridge a distance of 100 m but are sensitive to radiated electromagnetic interference: radiated electromagnetic interference (e.g. from GSM or switching inductive or capacitive loads) within the limits of electromagnetic compatibility requirements of 3 V/m can cause random flashes or temporary loss of the projected image.

As such, shielded CAT-6 cables with metal RJ-45 connectors are recommended; choose cable length no longer than required and route HDBT cable optimally screened from possible sources of electromagnetic emission.

## A.4 Specifications DisplayPort 1.2 inputs



For readability, the video timings listed are summarized. For the full list of video timings, refer to the appendices.

### DisplayPort 1.2 specifications

Pixel rate	Up to 600 MHz pixel clock		
Color space	<ul style="list-style-type: none"> <li>YCbCr 4:2:2</li> <li>YCbCr 4:4:4</li> <li>RGB 4:4:4</li> </ul>		
Color depth	<ul style="list-style-type: none"> <li>24 bpp</li> <li>30 bpp</li> <li>36 bpp</li> </ul>		
Data rate support	<ul style="list-style-type: none"> <li>1.62 Gbps: Reduced Bit Rate (RBR)</li> <li>2.7 Gbps: High Bit Rate (HBR)</li> <li>5.4 Gbps: High Bit Rate 2 (HBR2)</li> </ul>		
For future release	<ul style="list-style-type: none"> <li>Interlaced support</li> <li>HDCP 1.4</li> </ul>		
Audio	not supported		
3D support	<ul style="list-style-type: none"> <li>Field sequential 3D (Active 3D)</li> <li>Passive stereoscopic 3D (Passive stereo) converted to active 3D</li> </ul>		
Video timings progressive <sup>10</sup>	2D / 3D	Layout Mode <sup>11</sup>	Supported formats

10. For the full list of video timings, see Appendix

11. Only 1x1 layout is supported on the Quad Combo input Mk1 and Mk2. The Quad DP1.2 input supports all layout configurations.

	2D	Standard layout (1x1 layout)	<ul style="list-style-type: none"> <li>Up to 4096 x 2160 @24 Hz</li> <li>Up to 4096 x 2160 @30 Hz</li> <li>Up to 2048 x 1080 @48 Hz</li> <li>Up to 4096 x 2160 @50 Hz</li> <li>Up to 4096 x 2160 @60 Hz</li> <li>Up to 2560 x 1600 @120 Hz</li> </ul>
	2D	2 column mode (2x1 layout)	<ul style="list-style-type: none"> <li>1920 x 2160 @60 Hz</li> <li>1920 x 2160 @120 Hz</li> <li>1920 x 2400 @60 Hz</li> <li>2048 x 2160 @60 Hz</li> <li>2048 x 2160 @120 Hz</li> </ul>
	2D	4 quadrant mode (2x2 layout)	<ul style="list-style-type: none"> <li>960 x 1080 @120 Hz</li> <li>960 x 1200 @120 Hz</li> <li>1280 x 1080 @60 Hz</li> <li>1280 x 1080 @120 Hz</li> <li>1280 x 1600 @60 Hz</li> <li>1280 x 1600 @120 Hz</li> <li>1920 x 1080 @120 Hz</li> <li>1920 x 1200 @120 Hz</li> <li>2048 x 1080 @120 Hz</li> </ul>
	2D	4 column mode (4x1 layout)	<ul style="list-style-type: none"> <li>960 x 2160 @120 Hz</li> <li>960 x 2400 @120 Hz</li> <li>1024 x 2160 @60 Hz</li> </ul>
	Active 3D	Standard layout (1x1 layout)	<ul style="list-style-type: none"> <li>1600 x 1200 @120 Hz</li> <li>2560 x 1080 @120 Hz</li> <li>2560 x 1600 @120 Hz</li> </ul>
	Active 3D	2 column mode (2x1 layout)	1920 x 2160 @120 Hz
	Active 3D	4 quadrant mode (2x2 layout)	<ul style="list-style-type: none"> <li>1920 x 1080 @120 Hz</li> <li>1920 x 1200 @120 Hz</li> <li>2048 x 1080 @120 Hz</li> </ul>
	Active 3D	4 column mode (4x1 layout)	<ul style="list-style-type: none"> <li>960 x 2160 @120 Hz</li> <li>960 x 2400 @120 Hz</li> <li>1024 x 2160 @120 Hz</li> </ul>
	Passive stereo	Standard layout (1x1 layout)	3840 x 2160 @60 Hz
	Passive stereo	2 column mode (2x1 layout)	1920 x 2160 @60 Hz
<b>Native video timings</b>	<ul style="list-style-type: none"> <li>UDM-W: 1920 x 1200 @60 Hz</li> <li>UDM-4K: 3840 x 2400 @60 Hz</li> </ul>		



**CAUTION:** In order to display high resolution images (e.g.: 3840 x 2160 @60 Hz) via the DP1.2 input, the quality of the cable must be adequate, in addition the length of the cable can also influence the performance. In case there is an issue with one of these criteria the automatic link-training initiated by the DP-standard may decide to switch to a lower resolution.

## A.5 Specifications SFP inputs



For readability, the video timings listed are summarized. For the full list of video timings, refer to the appendices.

**SFP specifications**

<b>Color space</b>	YCbCr		
<b>Color depth</b>	10 bpc		
<b>Chroma sampling</b>	4:2:2		
<b>Audio support</b>	not supported		
<b>Video timings progressive<sup>12</sup></b>	<b>Type</b>	<b>Port type</b>	<b>Format</b>
	HD-SDI	Single link	<ul style="list-style-type: none"> <li>• Up to 1920 x 1080 @24 Hz</li> <li>• Up to 1920 x 1080 @25 Hz</li> <li>• Up to 1920 x 1080 @30 Hz</li> <li>• Up to 1280 x 720 @50 Hz</li> <li>• Up to 1280 x 720 @60 Hz</li> <li>• Up to 1280 x 720 @24 Hz</li> <li>• Up to 1280 x 720 @30 Hz</li> <li>• Up to 1280 x 720 @25 Hz</li> </ul>
	3G-SDI	Single link	1920 x 1080 @50 Hz and @60 Hz 1920 x 1200 @50 Hz, @59.94 Hz and @60 Hz. 2048 x 1080 @50 Hz and @60 Hz
12G-SDI	Single link	3840 x 2160 @50 Hz and @60 Hz 4096 x 2160 @50 Hz and @60 Hz 3840 x 2400 @50 Hz, @59.94 and @60 Hz	

12. For the full list of video timings, see Appendix

# Video timing tables

# B

B.1	Overview video timings .....	184
B.2	Overview video timings SDI Inputs .....	185
B.3	Overview video timings HDMI 2.0 inputs .....	186
B.4	Overview video timings DisplayPort 1.2 inputs .....	188
B.5	Overview video timings HDBaseT inputs .....	190

## About this chapter

This chapter contains the tables with video timings for video interfaces.

## B.1 Overview video timings

### List of compatible signals

The following table specifies the video signals that the projector can project. Barco Events projectors supports the signal with “X” in the Compatible signals column.

**Note:** Support for refresh rates 24.00, 30.00, 60.00 Hz automatically includes support of 1/1.001 x those refresh rates.

Resolution	Vertical refresh rate (Hz)	Compatible signal				
		HDMI 2.0 Inputs	12G SDI Input on Mk II Input board & Fiber Network Inputs	3G SDI Inputs	DisplayPort 1.2 Inputs	HDBaseT & HDMI 1.4 Inputs
640 x 480	60	X	—	—	X	X
720 x 480	60	X	—	—	—	X
720 x 576	50	X	—	—	—	X
800 x 600	60	X	—	—	X	X
1024 x 768	60	X	—	—	X	X
1280 x 720	24	—	X	X	—	—
1280 x 720	25	—	X	X	—	—
1280 x 720	30	—	X	X	—	—
1280 x 720	50	X	X	X	X	X
1280 x 720	60	X	X	X	X	X
1280 x 800	60	X	—	—	X	X
1280 x 960	60	X	—	—	X	X
1280 x 1024	60	X	—	—	X	X
1400 x 1050	60	X	—	—	X	X
1600 x 1200	60	X	—	—	X	X
1600 x 1200	120	—	—	—	X	—
1920 x 1080	24	X	X	X	X	X
1920 x 1080	25	X	X	X	—	X
1920 x 1080	30	X	X	X	—	X
1920 x 1080	50	X	X	X	X	X
1920 x 1080	60	X	X	X	X	X
1920 x 1080	120	—	—	—	X	—
1920 x 1200	50	X	X	X	X	X
1920 x 1200	60	X	X	X	X	X
1920 x 1200	120	—	—	—	X	—
2048 x 1080	24	X	—	—	X	X
2048 x 1080	25	X	—	—	X	X



Resolution	Vertical refresh rate (Hz)	Compatible signal				
		HDMI 2.0 Inputs	12G SDI Input on Mk II Input board & Fiber Network Inputs	3G SDI Inputs	DisplayPort 1.2 Inputs	HDBaseT & HDMI 1.4 Inputs
2048 x 1080	30	X	—	—	X	X
2048 x 1080	48	X	—	—	X	X
2048 x 1080	50	X	X	X	X	X
2048 x 1080	60	X	X	X	X	X
2048 x 1080	120	—	—	—	X	—
2560 x 1600	50	X	—	—	X	X
2560 x 1600	60	X	—	—	X	X
2560 x 1600	120	—	—	—	X	—
3840 x 2160	24	X	—	—	X	X
3840 x 2160	25	X	—	—	X	X
3840 x 2160	30	X	—	—	X	X
3840 x 2160	50	X	X	—	X	—
3840 x 2160	60	X	X	—	X	—
3840 x 2400	50	X	—	—	X	—
3840 x 2400	60	X	—	—	X	—
4096 x 2160	24	X	—	—	X	X
4096 x 2160	25	X	—	—	X	X
4096 x 2160	30	X	—	—	X	X
4096 x 2160	50	X	X	—	X	—
4096 x 2160	60	X	X	—	X	—

## B.2 Overview video timings SDI Inputs

### Overview

The following standard video formats are available for the projector.

Video timing (active pixels x active lines)	Vertical refresh rate (Hz) <sup>13</sup>	Type	Port Type
1280 x 720	24	HD-SDI	Single Link & Quad Link
1280 x 720	25	HD-SDI	Single Link & Quad Link
1280 x 720	30	HD-SDI	Single Link & Quad Link
1280 x 720	50	HD-SDI	Single Link & Quad Link

13. Support for refresh rates 24.00, 30.00 and 60.00 Hz automatically includes support of 1/1.001 x those refresh rates.

Video timing (active pixels x active lines)	Vertical refresh rate (Hz) <sup>14</sup>	Type	Port Type
1280 x 720	60	HD-SDI	Single Link & Quad Link
1920 x 1080	24	HD-SDI	Single Link & Quad Link
1920 x 1080	25	HD-SDI	Single Link & Quad Link
1920 x 1080	30	HD-SDI	Single Link & Quad Link
1920 x 1080	50	3G-SDI	Single Link & Quad Link
1920 x 1080	60	3G-SDI	Single Link & Quad Link
1920 x 1200	50	3G-SDI "BarcoLink"	Single Link & Quad Link
1920 x 1200	59.94	3G-SDI "BarcoLink"	Single Link & Quad Link
1920 x 1200	60	3G-SDI "BarcoLink"	Single Link & Quad Link
2048 x 1080	50	3G-SDI	Single Link & Quad Link
2048 x 1080	60	3G-SDI	Single Link & Quad Link
3840 x 2160	50	12G-SDI <sup>15</sup>	Single Link
3840 x 2160	60	12G-SDI <sup>15</sup>	Single Link
3840 x 2400	50	12G-SDI "BarcoLink 4k" <sup>15</sup>	Single Link
3840 x 2400	59.94	12G-SDI "BarcoLink 4k" <sup>15</sup>	Single Link
3840 x 2400	60	12G-SDI "BarcoLink 4k" <sup>15</sup>	Single Link
4096 x 2160	50	12G-SDI <sup>15</sup>	Single Link
4096 x 2160	60	12G-SDI <sup>15</sup>	Single Link

## B.3 Overview video timings HDMI 2.0 inputs

### Overview

The following standard video formats are available for the projector.

**Note:** support for refresh rates 24.00, 30.00, 60.00 Hz automatically includes support of 1/1.001 x those refresh rates

Video timing (active pixels x active lines)	Vertical refresh rate (Hz)	3D support?
640 x 480	60	
720 x 480	60	
720 x 576	50	
800 x 600	60	

14. Support for refresh rates 24.00, 30.00 and 60.00 Hz automatically includes support of 1/1.001 x those refresh rates.

15. 12G SDI board only, and only on Channel A

<b>Video timing (active pixels x active lines)</b>	<b>Vertical refresh rate (Hz)</b>	<b>3D support?</b>
1024x 768	60	
1280 x720	50	Frame packing Top – bottom
1280 x 720	60	Frame packing Top – bottom
1280 x 800	60	
1280 x 960	60	
1280 x1024	60	
1400 x 1050	60	
1600 x 1200	60	
1920 x 1080	24	Frame packing Top – bottom
1920 x 1080	25	
1920 x 1080	30	
1920 x 1080	50	Side by Side (SbS) progressive
1920 x 1080	60	Side by Side (SbS) progressive
1920 x 1200	50	
1920 x 1200	60	
2048 x 1080	24	
2048 x 1080	25	
2048 x 1080	30	
2048 x 1080	48	
2048 x 1080	50	
2048 x 1080	60	
2560 x 1600	50	
2560 x 1600	60	
3840 x 2160	24	
3840 x 2160	25	
3840 x 2160	30	
3840 x 2160	50	
3840 x 2160	60	
3840 x 2400	50	
3840 x 2400	60	
4096 x 2160	24	
4096 x 2160	25	
4096 x 2160	30	

Video timing (active pixels x active lines)	Vertical refresh rate (Hz)	3D support?
4096 x 2160	50	
4096 x 2160	60	

## B.4 Overview video timings DisplayPort 1.2 inputs

### Overview

The following standard video formats are available for the projector.

**Note:** support for refresh rates 24.00, 30.00, 60.00 Hz automatically includes support of 1/1.001 x those refresh rates

Video timing (active pixels x active lines)	Vertical refresh rate (Hz)	Available layout modes, other than standard layout (1 x 1 layout) <sup>16</sup>	Support for 3D?
640 x 480	60		
800 x 600	60		
960 x 1080	120	4 Quadrant mode (2 x 2 layout)	Active 3D
960 x 1200	120	4 Quadrant mode (2 x 2 layout)	Active 3D
960 x 2160	120	4 Column mode (4 x 1 layout)	Active 3D
960 x 2400	120	4 Column mode (4 x 1 layout)	Active 3D
1024x 768	60		
1024 x 2160	60	4 Column mode (4 x 1 layout)	
1024 x 2160	120	4 Column mode (4 x 1 layout)	Active 3D
1280 x720	50		
1280 x 720	60		
1280 x 800	60		
1280 x 960	60		
1280 x1024	60		
1280 x 1080	60	4 Quadrant mode (2 x 2 layout)	
1280 x 1080	120	4 Quadrant mode (2 x 2 layout)	Active 3D
1280 x 1600	60	4 Quadrant mode (2 x 2 layout)	

16. Other layout modes are only available on Input boards that have multiple DP inputs.

<b>Video timing (active pixels x active lines)</b>	<b>Vertical refresh rate (Hz)</b>	<b>Available layout modes, other than standard layout (1 x 1 layout)<sup>17</sup></b>	<b>Support for 3D?</b>
1280 x 1600	120	4 Quadrant mode (2 x 2 layout)	Active 3D
1400 x 1050	60		
1600 x 1200	60		
1600 x 1200	120		Active 3D
1920 x 1080	50		
1920 x 1080	60		
1920 x 1080	120	4 Quadrant mode (2 x 2 layout)	Active 3D
1920 x 1200	50		
1920 x 1200	60		
1920 x 1200	120	4 Quadrant mode (2 x 2 layout)	Active 3D
1920 x 2160	60	2 Column mode (2 x 1 layout)	Passive stereo
1920 x 2160	120	2 Column mode (2 x 1 layout)	Active 3D
1920 x 2400	60	2 Column mode (2 x 1 layout)	
2048 x 1080	24		
2048 x 1080	25		
2048 x 1080	30		
2048 x 1080	48		
2048 x 1080	50		
2048 x 1080	60		
2048 x 1080	120	4 Quadrant mode (2 x 2 layout)	Active 3D
2048 x 2160	60	2 Column mode (2 x 1 layout)	
2048 x 2160	120	2 Column mode (2 x 1 layout)	Active 3D
2560 x 1080	120		Active 3D
2560 x 1440	120		Active 3D
2560 x 1600	50		
2560 x 1600	60		
2560 x 1600	120		
3840 x 2160	24		

17. Other layout modes are only available on Input boards that have multiple DP inputs.

Video timing (active pixels x active lines)	Vertical refresh rate (Hz)	Available layout modes, other than standard layout (1 x 1 layout) <sup>18</sup>	Support for 3D?
3840 x 2160	25		
3840 x 2160	30		
3840 x 2160	50		
3840 x 2160	60		Passive Stereo
3840 x 2400	50		
3840 x 2400	60		
4096 x 2160	24		
4096 x 2160	25		
4096 x 2160	30		
4096 x 2160	50		
4096 x 2160	60		

## B.5 Overview video timings HDBaseT inputs

### Overview

The following standard video formats are available for the projector.

**Note:** support for refresh rates 24.00, 30.00, 60.00 Hz automatically includes support of 1/1.001 x those refresh rates.

Video timing (active pixels x active lines)	Vertical refresh rate (Hz)
640 x 480	60
720 x 480	60
720 x 576	50
800 x 600	60
1024 x 768	60
1280 x 720	50
1280 x 720	60
1280 x 800	60
1280 x 960	60
1280 x 1024	60
1400 x 1050	60
1600 x 1200	60
1920 x 1080	24
1920 x 1080	25
1920 x 1080	30
1920 x 1080	50

18. Other layout modes are only available on Input boards that have multiple DP inputs.

<b>Video timing (active pixels x active lines)</b>	<b>Vertical refresh rate (Hz)</b>
1920 x 1080	60
1920 x 1200	50
1920 x 1200	60
1920 x 2160	50
1920 x 2160	60
2048 x 1080	24
2048 x 1080	25
2048 x 1080	30
2048 x 1080	48
2048 x 1080	50
2048 x 1080	60
2048 x 2160	50
2048 x 2160	60
2560 x 1600	50
2560 x 1600	60
3840 x 2160	24
3840 x 2160	25
3840 x 2160	30
4096 x 2160	24
4096 x 2160	25
4096 x 2160	30





# DMX chart

# C

C.1	DMX chart input board positioning .....	194
C.2	DMX chart, Basic.....	194
C.3	DMX chart, Extended.....	195

## C.1 DMX chart input board positioning

### About the input boards

6 Input selection ranges are reserved in the DMX chart per input board location (named L1 and L2). With the current version of DMX support, it is important to take into account to keep the input boards in their original slots.

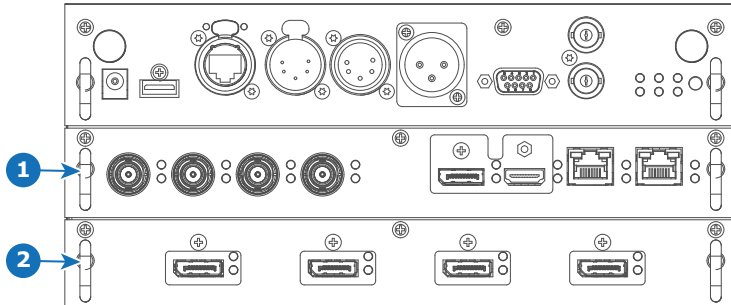

Image C-1

- 1 Slot L1, here filled with the Quad combo Input board
- 2 Slot L2, here filled with the Quad DP 1.2 Input board

## C.2 DMX chart, Basic

### Overview

Ch.	Function	Value	Default	Action
1	Shutter + Intensity	0 - 7	255	Close shutter
		8 - 255		Adjust intensity
2	Function select	0 - 7	0	No function
		8 - 15		Activate first profile preset (If held for 1 second)
		16 - 23		Activate second profile preset (If held for 1 second)
		24 - 31		Activate third profile preset (If held for 1 second)
		32 - 39		Activate fourth profile preset (If held for 1 second)
		40 - 47		Activate fifth profile preset (If held for 1 second)
		48 - 55		Activate sixth profile preset (If held for 1 second)
		56 - 63		Activate seventh profile preset (If held for 1 second)
		64 - 71		Activate eighth profile preset (If held for 1 second)
		72 - 79		Activate ninth profile preset (If held for 1 second)
		80 - 87		Activate tenth profile preset (If held for 1 second)
		88 - 95		Select input 1: HDMI Input (If held for 1 second) <sup>19</sup>
		96 - 103		Select input 2: DisplayPort Input (If held for 1 second) <sup>19</sup>
		104 - 111		Select input 3: SDI Input A (If held for 1 second) <sup>19</sup>
112 - 119	Select input 4: SDI Input B (If held for 1 second) <sup>19</sup>			
120 - 127	Select input 5: HDBaseT Input 1 (if held for 1 second) <sup>19</sup>			
128 - 135	Select input 6: Quad SDI input (if held for 1 second) <sup>19</sup>			

19. Only when the Quad Combo input board is installed in slot L1

Ch.	Function	Value	Default	Action
		136 - 143		Select input 7: Quad DP board Input A (if held for 1 second) <sup>20</sup>
		144 - 151		Select input 8: Quad DP board Input B (if held for 1 second) <sup>20</sup>
		152 - 159		Select input 9: Quad DP board Input C (if held for 1 second) <sup>20</sup>
		160 - 167		Select input 10: Quad DP board Input D (if held for 1 second) <sup>20</sup>
		168 - 175		Select input 11: Quad DP board Inputs A-B (if held for 1 second) <sup>20</sup>
		176 - 183		Select input 12: Quad DP board quad column mode (if held for 1 second) <sup>20</sup>
		184 - 207		Reserved for future functionality
		208 - 215		Power on / Light source on (If held for 5 seconds)
		216 - 223		Power down / Light source off (if held for 5 seconds)
		224 - 255		Reserved for future functionality

## C.3 DMX chart, Extended

### Overview

Ch.	Function	Value	Default	Actions
1	Shutter + Intensity	0 - 7	255	Close shutter
		8 - 255		Adjust intensity
2	Brightness	0 - 255	128	Adjusts the brightness between 0 and 100% on input.
3	Contrast	0 - 255	128	Adjusts the contrast between 0 and 100% on input
4	Input selection	0 - 7	0	No function
		8 - 15		Activate first profile preset (If held for 1 second)
		16 - 23		Activate second profile preset (If held for 1 second)
		24 - 31		Activate third profile preset (If held for 1 second)
		32 - 39		Activate fourth profile preset (If held for 1 second)
		40 - 47		Activate fifth profile preset (If held for 1 second)
		48 - 55		Activate sixth profile preset (If held for 1 second)
		56 - 63		Activate seventh profile preset (If held for 1 second)
		64 - 71		Activate eighth profile preset (If held for 1 second)
		72 - 79		Activate ninth profile preset (If held for 1 second)
		80 - 87		Activate tenth profile preset (If held for 1 second)
		88 - 95		Select input 1: HDMI Input (If held for 1 second) <sup>19</sup>
		96 - 103		Select input 2: DisplayPort Input (If held for 1 second) <sup>19</sup>
		104 - 111		Select input 3: SDI Input A (If held for 1 second) <sup>19</sup>
112 - 119	Select input 4: SDI Input B (If held for 1 second) <sup>19</sup>			
120 - 127	Select input 5: HDBaseT Input 1 (if held for 1 second) <sup>19</sup>			

20. Only when the Quad DisplayPort input board is installed in slot L2

Ch.	Function	Value	Default	Actions
		128 - 135		Select input 6: Quad SDI input (if held for 1 second) <sup>19</sup>
		136 - 143		Select input 7: Quad DP board Input A (if held for 1 second) <sup>20</sup>
		144 - 151		Select input 8: Quad DP board Input B (if held for 1 second) <sup>20</sup>
		152 - 159		Select input 9: Quad DP board Input C (if held for 1 second) <sup>20</sup>
		160 - 167		Select input 10: Quad DP board Input D (if held for 1 second) <sup>20</sup>
		168 - 175		Select input 11: Quad DP board Inputs A-B (if held for 1 second) <sup>20</sup>
		176 - 183		Select input 12: Quad DP board quad column mode (if held for 1 second) <sup>20</sup>
		184 - 255		Reserved for future functionality
5	Focus (MSB)	0 - 255	128	Set coarse lens focus adjustment <sup>21</sup>
6	Focus (LSB)	0 - 255	128	Set fine lens focus adjustment <sup>21</sup>
7	Zoom (MSB)	0 - 255	128	Set coarse lens zoom adjustment <sup>21</sup>
8	Zoom (LSB)	0 - 255	128	Set fine lens zoom adjustment <sup>21</sup>
9	Lens shift vertical (MSB)	0 - 255	128	Set coarse lens shift in vertical direction
10	Lens shift vertical (LSB)	0 - 255	128	Set fine lens shift in vertical direction
11	Lens shift horizontal (MSB)	0 - 255	128	Set coarse lens shift in horizontal direction
12	Lens shift horizontal (LSB)	0 - 255	128	Set fine lens shift in horizontal direction
13	Light Source Power <sup>22</sup>	0	0	Set light source to 100%
		1 - 61		Set light source to value From 100% to 40% in 1% reductions (e.g. 11 is 90%, 26 is 75%, etc)
		64		Set light source to 35%
		67		Set light source to 30%
		70		Set light source to 25%
		73		Set light source to 20%
		76		Set light source to 15%
		79		Set light source to 10%
		80 - 87		Power on / Light source on (If held for 5 seconds)
		88- 95		Power down / Light source off (if held for 5 seconds)
96 - 255	Reserved for future functionality			
14	Various	0 - 7	0	Reserved for future functionality
		8 - 15		Calibrate lens zoom & focus (if held for 5 seconds)
		16 - 23		Calibrate lens horizontal and vertical shift (if held for 5 seconds)

21. Only when lens has been calibrated

22. If the Light Source is forced to an output below its minimum value, it will remain at its minimum output value

<b>Ch.</b>	<b>Function</b>	<b>Value</b>	<b>Default</b>	<b>Actions</b>
		24 - 31		Calibrate lens (zoom, focus and shift) (if held for 5 seconds)
		32 - 255		Reserved for future functionality



# WiFi & GSM compliance information

# D

D.1	Compliance FCC .....	200
D.2	Compliance IC.....	200
D.3	KCC Certification .....	201

## About this chapter

This chapter contains important compliance information related to the WiFi and GSM module.



Regulatory information for US and Canada can be accessed in the OSD of the projector. In order access it, select *System Settings* → *Regulatory Information* → *Country*.

## D.1 Compliance FCC

### Federal Communication Commission Interference Statement

You are cautioned that changes or modifications not expressly approved by the part responsible for compliance could void the user's authority to operate the equipment.

This equipment has been tested and found to comply with the limits for a Class A digital device, pursuant to Part 15 of the FCC rules. These limits are designed to provide reasonable protection against harmful interference in a residential installation. This equipment generates, uses and can radiate radio frequency energy and, if not installed and used in accordance with the instructions, may cause harmful interference to radio communications. However, there is no guarantee that interference will not occur in a particular installation.

If this equipment does cause harmful interference to radio or television reception, which can be determined by turning the equipment off and on, the user is encouraged to try to correct the interference by one or more of the following measures:

- Reorient or relocate the receiving antenna.
- Increase the separation between the equipment and receiver.
- Connect the equipment into an outlet on a circuit different from that to which the receiver is connected.
- Consult the dealer or an experienced radio/TV technician for help.

**This device complies with Part 15 of the FCC Rules. Operation is subject to the following two conditions:**

1. This device may not cause harmful interference, and
2. This device must accept any interference received, including interference that may cause undesired operation of the device.

### FCC RF Radiation Exposure Statement:

1. This Transmitter must not be co-located or operating in conjunction with any other antenna or transmitter.
2. This equipment complies with RF radiation exposure limits set forth for an uncontrolled environment.  
This equipment should be installed and operated with a minimum distance of 20 cm between the radiator and your body.

## D.2 Compliance IC

### Radio Frequency (RF) exposure information

This equipment (IC 23575-R8767900X) complies with IC radiation exposure limits set forth for an uncontrolled environment.

This equipment should be installed and operated with a minimum distance of 20 centimeters between the radiator and your body.

### Industry Canada statement

This device complies with Industry Canada's license-exempt RSSs

Operation is subject to the following two conditions:

1. this device may not cause interference, and
2. this device must accept any interference, including interference that may cause undesired operation of the device.

Operation in the band 5150-5250 MHz is only for indoor use to reduce the potential for harmful interference to co-channel mobile satellite systems. For the frequency 5600-5650 MHz, no operation is permitted".

### Industry Canada class A emission compliance statement

This equipment has been tested and found to comply with the limits for a Class A digital device, pursuant to Canadian ICES-003.

These limits are designed to provide reasonable protection against harmful interference when the equipment is operated in a commercial environment. This equipment generates, uses, and can radiate radio frequency



energy and, if not installed and used in accordance with the instruction manual, may cause harmful interference to radio communications. Operation of this equipment in a residential area is likely to cause harmful interference in which case the user will be required to correct the interference at his own expense.

### Informations concernant l'exposition aux fréquences radio (RF)

Cet équipement (IC 23575-R8767900X) est conforme aux limites d'exposition aux rayonnements IC établies pour un environnement non contrôlé.

Cet équipement doit être installé et utilisé avec un minimum de 20 cm de distance entre la source de rayonnement et votre corps.

### Avis d'industrie Canada

Le présent appareil est conforme aux CNR d'Industrie Canada applicables aux appareils radio exempts de licence.

L'exploitation est autorisée aux deux conditions suivantes:

1. l'appareil ne doit pas produire de brouillage, et
2. l'utilisateur de l'appareil doit accepter tout brouillage radioélectrique subi, même si le brouillage est susceptible d'en compromettre le fonctionnement.

La bande 5 150-5 250 MHz est réservés uniquement pour une utilisation à l'intérieur afin de réduire les risques de brouillage préjudiciable aux systèmes de satellites mobiles utilisant les mêmes canaux.

Pour la fréquence 5600-5650 MHz, aucune opération est autorisée

### Avis de conformité a la réglementation d'Industrie Canada

Cet appareil numérique de la classe A est conforme a la norme NMB-003 du Canada.

## D.3 KCC Certification

### KCC 인증



기기명칭: 특정소출력무선기기(무선랜을 포함한 무선접속시스템용 무선기기)

인증자상호: Barco N.V.

모델명: eBox Pulse

인증번호: R-C-BVY-eBoxPulse

모듈 ID: KCC-CRM-TCS-HE910-D

제조연월: 2019.

제조사/제조국: Barco NV/벨기에와 중국

#### EMC 경고:

이 기기는 업무용 환경에서 사용할 목적으로 적합성평가를 받은 기기로서 가정용 환경에서 사용하는 경우 전파간섭의 우려가 있습니다.



# Regulatory information

# E

E.1	Product compliance .....	204
E.2	China RoHS compliance .....	205
E.3	Taiwan RoHS compliance.....	206
E.4	Turkey RoHS compliance.....	207
E.5	Disposal information .....	207
E.6	Contact information.....	208
E.7	Production address.....	208

## E.1 Product compliance

### UK Compliance

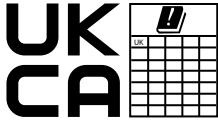

This product is fit for use in the UK.

**Authorised Representative:** Barco UK Ltd

**Address:** Building 329, Doncastle Road  
Bracknell RG12 8PE, Berkshire, United Kingdom

### EurAsian Conformity (EAC)



This product complies with the Safety of Low-Voltage Equipment (LVE Technical Regulation 004/2011, CU TR 004/2011) and the Electromagnetic Compatibility of Technical Products (EMC Technical regulation, CU TR 020/2011)

### Federal Communications Commission (FCC Statement)

This equipment has been tested and found to comply with the limits for a class A digital device, pursuant to Part 15 of the FCC rules. These limits are designed to provide reasonable protection against harmful interference when the equipment is operated in a commercial environment. This equipment generates, uses, and can radiate radio frequency energy and, if not installed and used in accordance with the instruction manual, may cause harmful interference to radio communications. Operation of this equipment in a residential area may cause harmful interference, in which case the user will be responsible for correcting any interference at his own expense

Changes or modifications not expressly approved by the party responsible for compliance could void the user's authority to operate the equipment

FCC responsible: Barco Inc.  
3059 Premiere Parkway Suite 400  
30097 Duluth GA, United States  
Tel: +1 678 475 8000

### EMC notices

#### EN55032/CISPR32 Class A MME (MultiMedia Equipment)

**Warning :** This equipment is compliant with Class A of CISPR 32. In a residential environment this equipment may cause radio interference.

#### GB/T 9254.1 A級ITE(信息技术设备)

**警告：**在居住环境中，运行此设备可能会造成无线电干扰。

#### BSMI Taiwan Class A statement:

**警告使用者：**此為甲類資訊技術設備，於居住環境中使用，可能會造成射頻擾動，在此情況下，使用者會被要求採取某些適當的對策。

### BSMI Reporting Obligor Information / 報驗義務人資訊

- 一、 商品在國內產製時，為商品之產製者或輸出者。  
但商品委託他人產製，並以在國內有住所或營業所之委託者名義，於國內銷售或輸出時，為委託者。
- 二、 商品在國外產製時，為商品之輸入者。  
但商品委託他人輸入，並以在國內有住所或營業所之委託者名義，於國內銷售時，為委託者。
- 三、 商品之產製者、輸出入者、委託產製或委託輸出入者不明或無法追查時，為銷售者。  
前項所稱產製者，包括具有下列情形之一者：
  - 一、 組裝者：商品由個別零組件以組裝銷售。
  - 二、 修改者：符合檢驗規定之商品於進入市場前，為銷售目的而修改。

## E.2 China RoHS compliance

### 中国大陆 RoHS (Information for China ROHS compliance)

根据中国大陆《电器电子产品有害物质限制使用管理办法》（也称为中国大陆RoHS），以下部分列出了Barco产品中可能包含的有毒和/或有害物质的名称和含量。中国大陆RoHS指令包含在中国信息产业部MCV标准：“电子信息产品中有毒物质的限量要求”中。

According to the “Management Methods for the Restriction of the Use of Hazardous Substances in Electrical and Electronic Products” (Also called RoHS of Chinese Mainland), the table below lists the names and contents of toxic and/or hazardous substances that Barco's product may contain. The RoHS of Chinese Mainland is included in the MCV standard of the Ministry of Information Industry of China, in the section “Limit Requirements of toxic substances in Electronic Information Products”.

零件项目(名称) Component name	有毒有害物质或元素 Hazardous substances and elements					
	铅 (Pb)	汞 (Hg)	镉 (Cd)	六价铬 (Cr6+)	多溴联苯 (PBB)	多溴二苯醚 (PBDE)
印制电路配件 Printed Circuit Assemblies	X	O	O	O	O	O
外接电(线)缆 External cables	X	O	O	O	O	O
内部线路 Internal wiring	X	O	O	O	O	O
镜头支架 Lens holder	X	O	O	O	O	O
光学镜头 Optical lenses	X	O	O	O	O	O
螺帽,螺钉(栓),螺旋(钉),垫圈,紧固件 Nuts, bolts, screws, washers, fasteners	X	O	O	O	O	O
激光发生器 Laser	X	O	O	O	O	O
电源供应器 Power Supply Unit	X	O	O	O	O	O
风扇 Fan	X	O	O	O	O	O
附電池遙控器 Remote control	X	O	O	O	O	O
泵 Pump	X	O	O	O	O	O

本表格依据SJ/T 11364的规定编制

This table is prepared in accordance with the provisions of SJ/T 11364.

O: 表示该有毒有害物质在该部件所有均质材料中的含量均在 GB/T 26572 标准规定的限量要求以下。

O: Indicates that this toxic or hazardous substance contained in all of the homogeneous materials for this part is below the limit requirement in GB/T 26572.

X: 表示该有毒有害物质至少在该部件的某一均质材料中的含量超出 GB/T 26572 标准规定的限量要求。

X: Indicates that this toxic or hazardous substance contained in at least one of the homogeneous materials used for this part is above the limit requirement in GB/T 26572.

在中国大陆销售的相应电子信息产品（EIP）都必须遵照中国大陆《电子电气产品有害物质限制使用标识要求》标准贴上环保使用期限（EFUP）标签。Barco产品所采用的EFUP标签（请参阅实例，徽标内部的编号使用于指定产品）基于中国大陆的《电子信息产品环保使用期限通则》标准。



All Electronic Information Products (EIP) that are sold within Chinese Mainland must comply with the “Marking for the restriction of the use of hazardous substances in electrical and electronic product” of Chinese Mainland, marked with the Environmental Friendly Use Period (EFUP) logo. The number inside the EFUP logo that Barco uses (please refer to the photo) is based on the “General guidelines of environment-friendly use period of electronic information products” of Chinese Mainland.

## E.3 Taiwan RoHS compliance

### 限用物質含有情況標示聲明書 (Declaration of the Presence Condition of the Restricted Substances Marking)

設備名稱： 投影機， 型號 (型式)： UDM Equipment name: Projector, Type designation: UDM						
	限用物質及其化學符號 Restricted substances and its chemical symbols					
單元 Unit	鉛 Lead (Pb)	汞 Mercury (Hg)	鎘 Cadmium (Cd)	六價鉻 Hexavalent chromium (Cr6+)	多溴聯苯 Polybrominated biphenyls (PBB)	多溴二苯醚 Polybrominated diphenyl ethers (PBDE)
印製電路板配件 Printed Circuit Assemblies	—	○	○	○	○	○
外接電 (線) 纜 External cables	—	○	○	○	○	○
內部線路 Internal wiring	—	○	○	○	○	○
光學鏡頭 Optical lenses	—	○	○	○	○	○
鏡頭支架 Lens holder	—	○	○	○	○	○
螺帽, 螺釘 (栓), 螺旋 (釘), 墊圈, 緊固件 Nuts, bolts, screws, washers, fasteners	—	○	○	○	○	○
激光發生器 Laser	—	○	○	○	○	○
電源供應器 Power Supply Unit	—	○	○	○	○	○
風扇 Fan	—	○	○	○	○	○
遙控器 Remote Control	—	○	○	○	○	○

<b>設備名稱： 投影機， 型號 (型式)： UDM</b> <b>Equipment name: Projector, Type designation: UDM</b>						
	<b>限用物質及其化學符號</b> <b>Restricted substances and its chemical symbols</b>					
<b>單元</b> <b>Unit</b>	<b>鉛</b> <b>Lead</b> <b>(Pb)</b>	<b>汞</b> <b>Mercury</b> <b>(Hg)</b>	<b>鎘</b> <b>Cadmium</b> <b>(Cd)</b>	<b>六價鉻</b> <b>Hexavalent chromium</b> <b>(Cr6+)</b>	<b>多溴聯苯</b> <b>Polybrominated biphenyls</b> <b>(PBB)</b>	<b>多溴二苯醚</b> <b>Polybrominated diphenyl ethers</b> <b>(PBDE)</b>
泵 Pump	—	○	○	○	○	○
<p>備考1. “超出0.1 wt %” 及 “超出0.01 wt %” 係指限用物質之百分比含量超出百分比含量基準值。 Note 1: “Exceeding 0.1 wt %” and “exceeding 0.01 wt %” indicate that the percentage content of the restricted substance exceeds the reference percentage value of presence condition.</p> <p>備考2. “○” 係指該項限用物質之百分比含量未超出百分比含量基準值。 Note 2: “○” indicates that the percentage content of the restricted substance does not exceed the percentage of reference value of presence.</p> <p>備考3. “—” 係指該項限用物質為排除項目。 Note 3: The “—” indicates that the restricted substance corresponds to the exemption.</p>						

## E.4 Turkey RoHS compliance

### Turkey RoHS compliance



Türkiye Cumhuriyeti: AEEE Yönetmeliğine Uygundur.  
[Republic of Turkey: In conformity with the WEEE Regulation]

## E.5 Disposal information

### Disposal Information



Waste Electrical and Electronic Equipment (WEEE)

This symbol on the product indicates that, under the European Directive 2012/19/EU governing waste from electrical and electronic equipment, this product must not be disposed of with other municipal waste. Please dispose of your waste equipment by handing it over to a designated collection point for the recycling of waste electrical and electronic equipment. To prevent possible harm to the environment or human health from uncontrolled waste disposal, please separate these items from other types of waste and recycle them responsibly to promote the sustainable reuse of material resources.

For more information about recycling of this product, please contact your local city office or your municipal waste disposal service. For details, please visit the Barco website at: <http://www.barco.com/AboutBarco/weee>

## Disposal of batteries in the product



This product contains batteries covered by the Directive 2006/66/EC which must be collected and disposed of separately from municipal waste.

If the battery contains more than the specified values of lead (Pb), mercury (Hg) or cadmium (Cd), these chemical symbols will appear below the crossed-out wheeled bin symbol.

By participating in separate collection of batteries, you will help to ensure proper disposal and to prevent potential negative effects on the environment and human health.

## E.6 Contact information

### Barco contact information

Registered office address: Habornveien 53, N-1630 Gamle Fredrikstad, Norway

Contact address: Beneluxpark 21, 8500 Kortrijk, Belgium

### Importers contact information

To find your local importer, contact Barco directly or one of Barco's regional offices via the contact information given on Barco's web site, [www.barco.com](http://www.barco.com).

## E.7 Production address

### Factories

#### Barco NV (BELGIUM)

President Kennedypark 35, B-8500 Kortrijk

#### CFG Barco (Beijing) Electronics Co., Ltd.

#### 中影巴可 (北京) 电子有限公司\*

No. 16, Changsheng Road Changping Park, Changping District, 102200, Beijing, P.R.C

北京市昌平区中关村科技园区昌盛路16号巴可工厂第三层: 102200

### Made in information

The made in country is indicated on the product ID label on the product itself.

### Production date

The month and year of production is indicated on the product ID label on the product itself.



# Glossary

## **Default Gateway**

A router that serves as an entry point into and exit point out of a network. For example, a local network (LAN) may need a gateway to connect it to a wide area network (WAN) or to the Internet.

## **DHCP**

Dynamic host configuration protocol. DHCP is a communications protocol that lets network administrators manage centrally and automate the assignment of IP addresses in an organization's network. Using the Internet Protocol, each machine that can connect to the Internet needs a unique IP address. When an organization sets up its computer users with a connection to the Internet, an IP address must be assigned to each machine. Without DHCP, the IP address must be entered manually at each computer and, if computers move to another location in another part of the network, a new IP address must be entered. DHCP lets a network administrator supervise and distribute IP addresses from a central point and automatically sends a new IP address when a computer is plugged into a different place in the network.

## **DMX**

DMX-512 Lighting protocol over RS-485 interface. Carries information of 512 channels from a lighting controller to lighting devices. Standardized by USITT.

## **HD**

Hazard Distance (HD) is the distance measured from the projection lens at which the intensity or the energy per surface unit becomes lower than the applicable exposure limit on the cornea or on the skin. The light beam is considered (to be) unsafe for exposure if the distance from a person to the light source is less than the HD.

## **IP**

Internet Protocol. The network layer of TCP/IP. Required for communication with the internet.

## **Latency**

The total time from the first pixel is coming in on an input source, until the first light representing that pixel is visible on the screen. This includes the transport delay. The value is normally given in milliseconds.

## **MAC address**

Media Access Control address. Unique hardware number, used in combination with the IP-address to connect to the network (LAN or WAN).

**RS232**

An Electronic Industries Association (EIA) serial digital interface standard specifying the characteristics of the communication path between two devices using either D-SUB 9 pins or D-SUB 25 pins connectors. This standard is used for relatively short-range communications and does not specify balanced control lines. RS-232 is a serial control standard with a set number of conductors, data rate, word length and type of connector to be used. The standard specifies component connection standards with regard to computer interface. It is also called RS-232-C, which is the third version of the RS-232 standard, and is functionally identical to the CCITT V.24 standard. Logical '0' is  $> + 3V$ , Logical '1' is  $< - 3V$ . The range between  $-3V$  and  $+3V$  is the transition zone.

**RS422**

An EIA serial digital interface standard that specifies the electrical characteristics of balanced (differential) voltage, digital interface circuits. This standard is usable over longer distances than RS-232. This signal governs the asynchronous transmission of computer data at speeds of up to 920,000 bits per second. It is also used as the serial port standard for Macintosh computers. When the difference between the 2 lines is  $< - 0.2V$  that equals with a logical '0'. When the difference is  $> +0.2V$  that equals to a logical '1'.

**Subnet mask**

A number that is used to identify a subnetwork so that IP addresses can be shared on a local area network.

**Transport latency**

The added delay in the image processing chain. The value is the number of lines relative to the output resolution.

## List of tools

Clean cotton cloth

Clean micro fiber lens cleaning cloth (e.g. Toraysee® cloth(s))

Compressed air

Flat screwdriver 5mm

Lens cleaner (e.g. ZEISS lens cleaner, Purosol™ or other water based lens cleaner products)

Level



# Index

## Numbers/Symbols

3D emitter  
  setup 113  
3D projection 111  
3D setup 112

## A

Active 3D 111  
  setup 113  
Active Stereo 111  
Address  
  Program  
    RCU 34  
Alignment  
  Warping 87  
    4 Corners 91  
    Bow 93  
    Files 97  
    Latency Control 99  
    On/Off 88  
    Screen Size 88

## B

Backlight  
  Control 138  
  LCD Display 138  
Battery  
  Disposal 208  
Blending 100  
  Basic blend 101, 103  
  Black level adjustment 106  
    Files 109  
    RGB adjustment 108  
  Black Level Files 109  
  Blend Files 105  
  Blend mask 103  
  Blend Zones 103  
  Masking 103

  RGB adjustment 108  
  RGB gain 108  
Brightness 62

## C

CE Certification 20  
Clean  
  Exterior 169  
  Filters 169  
  Lens 169  
Cleaning  
  Exterior 172  
  Lens 171  
Communication 37  
  DMX 40  
  Introduction 38  
  IR control  
    Broadcast address 122  
    IR sensors 123  
    Projector address 122  
  Remote control  
    Broadcast address 122  
    Projector address 122  
  RS232 40  
  RS422 40  
  USB port 41  
Communication panel 40  
Compliance 20  
  GSM 199  
  Product 204  
  WiFi 199  
Compliance FCC 200  
Compliance IC 200  
Connect  
  Source 25  
Connection possibilities 112  
Contact address 208  
Contact information 208  
Contrast 62  
Convergence 151  
Cooling liquid circuit warning 13

Create profile 117  
 Custom projector name 124

## D

Digital Shift 67  
 Digital Zoom 67  
 Display  
   Multiple sources 56  
   Single source 56  
 DisplayPort 1.2 inputs  
   Specifications 180  
 Disposal 207  
   Battery 208  
 DMX 133  
 DMX chart 193  
   Basic 194  
   Extended 195  
 DMX Chart  
   Input mapping 194  
 DMX input 40  
 DMX interface 40  
 DMX out 40  
 Download  
   Product manual 20

## E

Electronic Convergence 151  
 Enclosed projection 18  
 Environment conditions 23  
 Environmental information  
   Disposal information 207  
   RoHS compliance  
     China 205  
     Taiwan 206  
     Turkey 207  
 Ethernet connection 125  
   IP address, wired connection 126  
   IP address, wireless connection 128  
 EurAsian Conformity (EAC) 204  
 Exterior  
   Cleaning 172

## F

Fiber  
   Input 46  
   SFP 46  
 Flex brightness 149  
 Focus 78  
 Function  
   Button pressed indicator 33

## G

Gamma correction 64  
 Gamma type  
   DICOM 65  
   sRGB 65  
 General Considerations 10

Getting started 21  
 Graphic User Interface  
   Overview 48  
 Graphics User Interface 47  
 GSM  
   Compliance 199  
 GSM activation  
   SIM card 135  
 GUI  
   Image 61  
   Installation 77  
   Introduction 47  
   Navigation 51  
   Overview 48  
   Test Patterns 53

## H

Hazard Distance 16, 18  
   Modifying optics 19  
 Hazardous Chemicals 15  
 HDBaseT inputs  
   Specifications 179  
 HDBaseT™ connection  
   IP address, wired connection 131  
 HDMI inputs  
   Specifications 178  
 High Brightness precautions 16  
 Host name 124

## I

Illumination 110  
 Image  
   DynaBlack 74  
   Dynamic contrast 74  
   Gamma 64–65  
   HDR 73  
   Perceptual Quantizer 73  
   PQ 73  
   Sharpness 63  
 Image projection 25  
 Importer 208  
 Input 37  
   Fiber 46  
   Introduction 38  
   Quad Combo Mk I 44  
   Quad Combo Mk II 43  
   Quad DP 1.2 45  
   SFP 46  
   Small Form-factor Pluggable 46  
 Input & Communication  
   Terminology overview 38  
 Installation requirements  
   Environment conditions 23  
 Introduction  
   GUI 47  
 IR control  
   Broadcast address 122  
   IR sensors 123  
   Projector address 122

**K**

KCC Certification 201  
KCC 인증 201

**L**

Laser Banks  
  Status 162  
Laser radiation 11  
Laser range finder 82  
Laser ranging 82  
LED behavior  
  Quad Combo Mk I 44  
  Quad Combo Mk II 43  
  Quad DP 1.2 45  
  SFP 46  
Lens  
  Adjustment  
    Calibration 148  
  Cleaning 171  
  Dynamic focus 79  
  Focus 78  
  Focus drift compensation 79  
  Shift 78  
  Shift to center 80  
  Tilt sensor 81  
  Zoom 78  
Lens adjustment  
  Calibration 148  
Lens features 143  
Lens shift 78  
Local keypad  
  Functionality overview 38

**M**

Macro  
  Delete 119  
Maintenance  
  Clean exterior 169  
  Clean filters 169  
  Clean lens 169  
  Software updated 169  
Masking 100  
Measuring system 138  
mini-jack  
  RCU 35  
Mobile activation  
  SIM card 135  
Motorized frame  
  XLR connector 135  
Multiple sources  
  Display 56

**N**

Network  
  Introduction 125  
Network connection 125  
  IP address, wired connection 126  
  IP address, wireless connection 128

Notice on optical radiation  
  Optical radiation 10

**O**

Open source licenses 155  
Orientation 85  
  Projector 22  
Overview video timings 184

**P**

P7  
  RealColor 71  
Passive 3D 111  
Passive stereo 111  
Power off 28  
Power on 24  
Prevent  
  Damage 14  
  Electrical shock 11  
  Fire hazard 13  
  Personal injury 12  
Product safety labels 15  
Production address 208  
Profile  
  Delete 119  
Profile setup matrix  
  Profile 116  
Profiles  
  Introduction 116  
  Preset variables 115  
Projector  
  Components 22  
  Orientation 22  
Projector control  
  DMX 133  
  Network  
    Introduction 125  
  XLR connector 135  
Pulse  
  RCU 29  
  Remote Control Unit 29  
Pulse RCU  
  battery 30  
  Functionality overview 33  
  on/off button 31  
  protection sleeve 35  
  Protocol setup 31  
  RGB button 34  
  RGB filter 34

**Q**

Quad Combo Mk I  
  Introduction 44  
  LED behavior 44  
Quad Combo Mk II  
  Introduction 43  
  LED behavior 43  
Quad DP 1.2  
  Introduction 45

LED behavior 45

## R

### RCU

Address 34  
mini-jack 35  
Use 32  
XLR 34

Ready mode 28

### RealColor

P7 71

Rear projection 18

Registered office 208

Regulatory information 203

### Remote access

Camera preview 159  
Source preview 158

### Remote control

Broadcast address 122  
Projector address 122

### Reset

3D settings 144  
All 144  
Blending 144  
DMX 144  
Features 144  
Illumination 144  
Image 144  
Network settings 144  
Optics 144  
Orientation 144  
Other 144  
Projector Profiles 144  
Test Patterns 144  
User Interface 144  
User Interface settings 144  
Warping 144

Rigging frame 83

Center position 85

RS232 40

RS422 40

## S

### Safety

Battery explosion 13  
Cooling liquid circuit 13  
Environment 9  
Hazard Distance 16, 18  
Hazardous Chemicals 15  
Important instructions 11  
Safety Data Sheet (SDS) 15  
Servicing 14  
Stacking 15

Safety Data Sheet (SDS) 15

Safety instructions 10

Safety Notice 10

Saturation 62

Scaling modes 86

### SDI inputs

Specifications 178

Serial communication 40

### Service

Convergence 151  
Electronic Convergence 151

### Settings

Capture mode 154  
Date and time  
Automatically 140  
Manually 139  
General  
Open source licenses 155

### SFP

Introduction 46  
LED behavior 46

### SFP inputs

Specifications 181

### SIM card

Blocked 136

### Single source

Display 56

### Software

Update 169

Software update 170

### Solarization

Capture mode 154  
Remove 154

### Source 55

Connect 25  
Connector Settings 58  
Fiber 46  
SFP 46  
Single source 56  
Small Form-factor Pluggable 46

### Specifications 177

DisplayPort 1.2 inputs 180  
HDBaseT inputs 179  
HDMI inputs 178  
SDI inputs 178  
SFP inputs 181

Standard source files 183

Standby mode 28

### Start

Image projection 25

Status Light 42

Status menu 165

Overview 166

Stealth mode 138

Stitched layouts 56

Switching off 28

Switching on 24

Switching to ready mode 28

Switching to standby mode 28

### System settings

Advanced settings  
Login 154  
Language 136  
User interface  
language 136

System Settings 121, 137

Advanced settings 157

Advanced Settings

Color 160

Statistics 161

Communication 125



- IP address, HDBaseT™ 131
- IP address, wired connection 126
- IP address, wireless connection 128
- ECO mode
  - Power settings 142
- Factory reset 144
- Flex brightness 149
- Frame 150
- Frame Calibration 150
- Lens adjustment
  - Calibration 148
- Lens features 143
- Maintenance 157
- Network 125
- Operational mode
  - Silent mode 153
- Power saving settings
  - ECO mode 142
  - Standby ECO mode 142
  - Standby mode 142
- Service 157
- Units
  - Distance 138
  - Temperature 138

## T

- Test Patterns 53
- Themes 137
- Tilt sensor
  - Calibration 163
- Touch panel 39
- Turkey RoHS 207

## U

- UK Compliance 20, 204
- Units 138
- Update
  - Software 169
- USB port 41
- User definition 11

## V

- Video timings
  - DisplayPort Inputs 188
  - HDBaseT Inputs 190
  - HDMI Inputs 186
- Video Timings
  - SDI Inputs 185

## W

- Warnings
  - Cooling liquid circuit 13
- Warping 87
- WEEE 207–208
- WiFi
  - Compliance 199

## X

- XLR
  - RCU 34
- XLR connector
  - Control 135

## Z

- Zoom 78







R5911443 /08 | 2022-10-19

[www.barco.com](http://www.barco.com)