

Event Master Devices

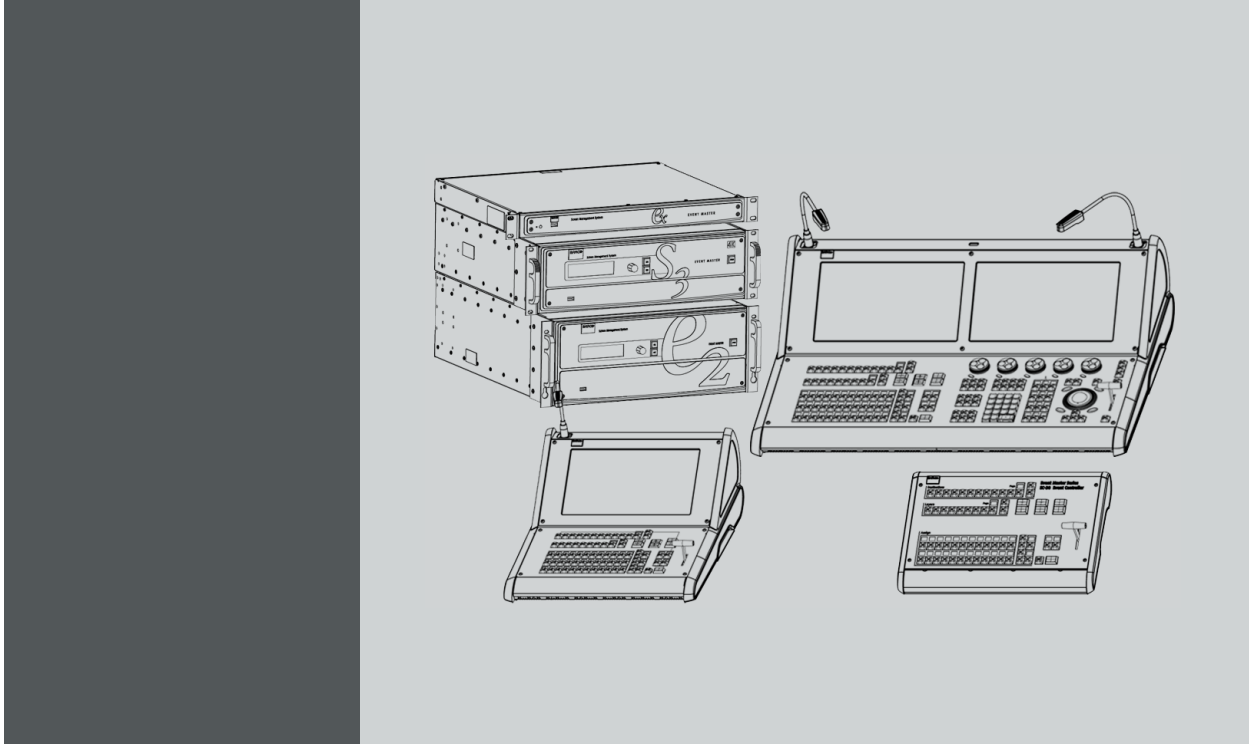

User's Guide

Barco Inc, Image Processing

3078 Prospect Park Drive, Rancho Cordova, CA , 95670, USA

Phone: +1 916 859-2500

Fax: +1 916 859-2515

Support: www.barco.com/en/support

Visit us at the web: www.barco.com

Changes

Barco provides this manual 'as is' without warranty of any kind, either expressed or implied, including but not limited to the implied warranties or merchantability and fitness for a particular purpose. Barco may make improvements and/or changes to the product(s) and/or the program(s) described in this publication at any time without notice.

This publication could contain technical inaccuracies or typographical errors. Changes are periodically made to the information in this publication; these changes are incorporated in new editions of this publication.

The latest edition of Barco manuals can be downloaded from the Barco web site www.barco.com or from the secured Barco web site <https://www.barco.com/en/signin>.

Copyright ©

All rights reserved. No part of this document may be copied, reproduced or translated. It shall not otherwise be recorded, transmitted or stored in a retrieval system without the prior written consent of Barco.

Guarantee and Compensation

Barco provides a guarantee relating to perfect manufacturing as part of the legally stipulated terms of guarantee. On receipt, the purchaser must immediately inspect all delivered goods for damage incurred during transport, as well as for material and manufacturing faults Barco must be informed immediately in writing of any complaints.

The period of guarantee begins on the date of transfer of risks, in the case of special systems and software on the date of commissioning, at latest 30 days after the transfer of risks. In the event of justified notice of complaint, Barco can repair the fault or provide a replacement at its own discretion within an appropriate period. If this measure proves to be impossible or unsuccessful, the purchaser can demand a reduction in the purchase price or cancellation of the contract. All other claims, in particular those relating to compensation for direct or indirect damage, and also damage attributed to the operation of software as well as to other services provided by Barco, being a component of the system or independent service, will be deemed invalid provided the damage is not proven to be attributed to the absence of properties guaranteed in writing or due to the intent or gross negligence or part of Barco.

If the purchaser or a third party carries out modifications or repairs on goods delivered by Barco, or if the goods are handled incorrectly, in particular if the systems are operated incorrectly or if, after the transfer of risks, the goods are subject to influences not agreed upon in the contract, all guarantee claims of the purchaser will be rendered invalid. Not included in the guarantee coverage are system failures which are attributed to programs or special electronic circuitry provided by the purchaser, e.g. interfaces. Normal wear as well as normal maintenance are not subject to the guarantee provided by Barco either.

The environmental conditions as well as the servicing and maintenance regulations specified in this manual must be complied with by the customer.

Trademarks

Brand and product names mentioned in this manual may be trademarks, registered trademarks or copyrights of their respective holders. All brand and product names mentioned in this manual serve as comments or examples and are not to be understood as advertising for the products or their manufacturers.

Software License Agreement

You should carefully read the following terms and conditions before using this software. Your use of this software indicates your acceptance of this license agreement and warranty.

Terms and Conditions:

1. No redistribution of the software is allowed.
2. Reverse-Engineering. You may not reverse engineer, decompile, disassemble or alter this software product.

Disclaimer of Warranty:

This software and the accompanying files are sold "as is" and without warranties as to performance or merchantability or any other warranties whether expressed or implied. In no event shall Barco be liable for damage of any kind, loss of data, loss of profits, business interruption or other pecuniary loss arising directly or indirectly. Any liability of the seller will be exclusively limited to replacement of the product or refund of purchase price.

Federal Communications Commission (FCC Statement)

This equipment has been tested and found to comply with the limits for a class A digital device, pursuant to Part 15 of the FCC rules. These limits are designed to provide reasonable protection against harmful interference when the equipment is operated in a commercial environment. This equipment generates, uses, and can radiate radio frequency energy and, if not installed and used in accordance with the instruction manual, may cause harmful interference to radio communications. Operation of this equipment in a residential area may cause harmful interference, in which case the user will be responsible for correcting any interference at his own expense

Changes or modifications not expressly approved by the party responsible for compliance could void the user's authority to operate the equipment

EN55032/CISPR32 Class A Multimedia Equipment

Warning: This equipment is compliant with Class A of CISPR 32. In a residential environment this equipment may cause radio interference.

사용자안내문

사 용 자 안 내 문
이 기기는 업무용 환경에서 사용할 목적으로 적합성평가를 받은 기기로서 가정용 환경에서 사용하는 경우 전파간섭의 우려가 있습니다.

※ 사용자 안내문은 "업무용 방송통신기자재"에만 적용한다.

Warning statement:

EMC Registration is done on this equipment for business use only. It may cause interference when the product would be used in home.

- This warning statement applies to a product for business use.

사용자 안내문

이 기기는 업무용 환경에서 사용할 목적으로 적합성평가를 받은 기기로서 가정용 환경에서 사용하는 경우 전파간섭의 우려가 있습니다.

TABLE OF CONTENTS

1. Introduction	7
1.1 About this guide	8
1.2 Record of changes	9
1.3 Symbols, pictures and fonts	12
1.4 The 4K screen management system	13
2. Safety	15
2.1 General considerations	16
2.2 Important safety instructions	17
3. General	19
3.1 Event Master devices overview	20
3.2 Event Master series processors features	24
3.3 Event Master controllers features	29
3.4 Terms and definitions	31
3.5 Control overview	34
3.6 Presentation System overview	35
3.7 Installation requirements	36
3.8 Initial inspection	37
3.9 Rack-Mount Procedure	40
4. Hardware orientation	43
4.1 Front panel	44
4.2 Rear panel	46
4.3 SDI Input Card	51
4.4 Dual Link DVI Input Card	53
4.5 HDMI/DisplayPort Input Card	55
4.6 Tri-Combo Input Card	57
4.7 Quad Channel DisplayPort Output Card	60
4.8 HDMI Output Card	62
4.9 SDI Output Card	63
4.10 Tri-Combo Output Card	65
4.11 Expansion Link card	68
4.12 VPU card	69
5. Front Panel Menu orientation	71
5.1 Power-up initialization	72
5.2 Front Panel menu tree	73
5.3 Using menu system	74
5.4 About Status menu	76
5.5 About Setup menu	77
5.6 About the System menu	78
5.7 System menu > Black Invalid	79
5.8 System menu > USB device (Backup/Restore)	80
5.9 System menu > Ethernet	84
5.10 System menu > VFD brightness (display brightness)	86
5.11 System menu > Diagnostics	87
5.12 System menu > Lock front panel	91
5.13 Using the Tech Support menu	92
5.14 Restoring Factory Default Settings	93
5.15 Firmware Upgrade	94
5.16 Save All	95
6. EM GUI orientation	97
6.1 General requirements	99
6.2 Download of Event Master Toolset Software	100
6.3 Software installation	101
6.4 Starting up	102
6.5 Screen layout presentation	103
6.6 Controls	105
6.7 Configuration Menu	106
6.8 Configuration Menu > Network resource area	108
6.9 Configuration Menu > System diagram area	110
6.10 Configuration Menu > System modifier area	113
6.11 Configuration Menu > Adjustment area	114
6.12 Configuration Menu > Adjustment > Unit Configuration	115
6.13 Configuration Menu > Adjustment > Input Configuration	117
6.14 Configuration Menu > Adjustment > Background Configuration	127
6.15 Configuration Menu > Adjustment > Output Configuration	130
6.16 Configuration Menu > Adjustment > Destination Configuration	138
6.17 Configuration Menu > Linking	156
6.18 Programming Menu	173
6.19 Programming Menu > Resources area	174

6.20	Programming Menu > Diagram area	187
6.21	Programming Menu > Layer Modifier area	190
6.22	Programming Menu > Adjustment area	194
6.23	Programming Menu > Adjustment area > Layer configuration	195
6.24	Programming Menu > Adjustment area > Dest Group configuration	203
6.25	Programming Menu > Adjustment area > Background configuration	206
6.26	Programming Menu > Adjustment area > User Keys configuration	208
6.27	Programming Menu > Adjustment area > Presets configuration	210
6.28	Programming Menu > Adjustment area > Source adjustment	213
6.29	Programming Menu > Adjustment area > Global Transition Rate/Trans/Cut	215
6.30	Multiviewer (MVR) Menu	216
6.31	Multiviewer Menu > Resource area	217
6.32	Multiviewer Menu > Multiviewer Layout area	218
6.33	Multiviewer Menu > Modifier area	220
6.34	Multiviewer Menu > Adjustment area	221
6.35	Multiviewer Menu > Adjustment area > Output Color	222
6.36	Multiviewer Menu > Adjustment area > Window adjustment	223
6.37	Controller Menu	224
6.38	Settings Menu	225
6.39	Settings Menu > Web App area	230
6.40	Settings Menu > Web App area > Dashboard	231
6.41	Settings Menu > Web App area > Tools	235
6.42	Settings Menu > Web App area > Tools > Manage Software	236
6.43	Settings Menu > Web App area > Tools > Backup & Restore	238
6.44	Settings Menu > Web App area > Help	240
6.45	Settings Menu > Web App area > Contact us	241
6.46	Settings Menu > Web App area > Follow us	242
7.	System Setup	243
7.1	Setup Prerequisites	244
7.2	System setup sequence	245
7.3	Power up and Status check	246
7.4	Return to factory default	247
7.5	Communication setup	248
7.6	Restoring the system	249
7.7	User preference setup	250
7.8	Saving the setup	251
7.9	Backing up the system	252
7.10	Configuration Menu > Initial Setup	253
7.11	Configuration Menu > Add Background(s)	254
7.12	Configuration Menu > Add Inputs	255
7.13	Configuration Menu > Add Outputs	257
7.14	Configuration Menu > Add Screen Destinations & Layers	260
7.15	Configuration Menu > Layer optimization	263
7.16	Configuration Menu > Add Aux Destinations	264
7.17	Configuration Menu > Add MVR Outputs	266
7.18	Programming Menu > Capture Stillstore from Inputs & Backgrounds	268
7.19	Programming Menu > Select Thumbnails for Backgrounds	269
7.20	Programming Menu > Select Thumbnails for Inputs	270
7.21	Programming Menu > Create Sources from Inputs	271
7.22	Programming Menu > Drop backgrounds into Screen Destinations	272
7.23	Programming Menu > Drop Sources, Layers into Screen Destinations & Sources into layers	273
7.24	Programming Menu > Drop Inputs to Aux Destinations	275
7.25	Programming Menu > Presets And User Keys	276
7.26	Programming Menu > Destination Transition	277
7.27	Multiviewer Menu > Drop Inputs, Backgrounds and Destinations	278
8.	Updating firmware	279
8.1	Upgrading firmware using the USB port	280
8.2	Upgrading firmware using the web Upgrade	282
9.	General operation example	285
9.1	Event requirements	286
9.2	Preliminary	287
9.3	Control Software Operation	289
9.4	Configuration Menu	290
9.5	Programming Menu	295
9.6	Multiviewer (MVR) Menu	306
10.	Controller orientation	309
10.1	General description	310
10.2	EC-30 front panel overview	312
10.3	EC-30 backside overview	313
10.4	EC-50 front panel overview	314
10.5	EC-50 backside overview	315
10.6	EC-200 front panel overview	316
10.7	EC-200 backside overview	317

10.8	Use of color	318
10.9	Touch screen	319
10.10	Destinations buttons	320
10.11	Layer buttons	321
10.12	Assign buttons with contextual displays	322
10.13	T-Bar	323
10.14	Transition buttons	324
10.15	Future Expansion Button Group (EC-200 only)	325
10.16	Direct Selection Button Group and Barco Eye Button (EC-200 only)	326
10.17	System Function Button Group (EC-200 only)	327
10.18	Syntax Entry Button Group (EC-200 only)	328
10.19	Contextual Display Button Group (EC-200 only)	329
10.20	Num Pad Button Group (EC-200 only)	330
10.21	Live Function Button Group (EC-200 only)	331
10.22	Trackball (EC-200 only)	332
10.23	Rotary Encoders (EC-200 only)	333
10.24	Panel Lock button (EC-200 only)	334
10.25	Save Button (EC-200 only)	335
11.	Controller Configuration	337
11.1	General	338
11.2	EC-30 controller connection	339
11.3	EC-50 controller connection	340
11.4	EC-200 controller connection	341
11.5	Touch screen calibration	342
11.6	Lights	343
11.7	Assigning resources to the desk	344
12.	Controller Operation	347
12.1	General Overview	348
12.2	EC-200 Firmware Upgrade	349
12.3	How to power down the EC-200	350
12.4	How to reboot the EC-200 CPU	351
12.5	How to select destinations	352
12.6	How to use the Layer buttons	353
12.7	What are Layer executers?	354
12.8	How to use assign Buttons	355
12.9	How to use the page arrow buttons	356
12.10	How to use transition buttons	357
12.11	How to use the T-bar	358
12.12	How to use the Contextual Display Buttons	359
12.13	EC-200 Philosophy	360
12.14	Function Button For Syntax	362
12.15	Additional direct access and functionality	367
13.	Preventive maintenance actions	373
13.1	E2 maintenance actions	374
13.2	S3 maintenance actions	375
13.3	EX maintenance actions	376
13.4	EC-30 maintenance actions	377
13.5	EC-50 maintenance actions	378
13.6	EC-200 maintenance actions	379
14.	E2 Maintenance	381
14.1	E2 unit Overview	383
14.2	Process Overview	384
14.3	Spare Parts Serviceable by All Users	386
14.4	Rear I/O and Link Cards	387
14.5	Rear I/O, VPU and Link card Heatsink Fan	389
14.6	Front Cover Assembly	390
14.7	Front Brackets	393
14.8	3RU Fan Tray	394
14.9	1RU Fan Tray	395
14.10	VPU Card(s)	397
14.11	Front Panel Knob	399
14.12	Front Panel Mount	401
14.13	Front Panel Board	402
14.14	VFD Display Assembly	404
14.15	VFD Display Filter	405
14.16	Bottom Panel	406
14.17	Solid-State Memory	407
14.18	System Battery	409
14.19	CPU Module	411
14.20	Power Supply	413
14.21	System-Power Board	415
14.22	Genlock Assembly	419
14.23	USB Cable	422

Table of contents

14.24	USB Extension Cable	425
14.25	VFD Cable	427
14.26	Keyboard Cable	429
14.27	Genlock Cable	431
14.28	Ethernet Cable	433
14.29	3RU Fan Cable	434
14.30	1RU Fan Cable	438
14.31	Rear Rack Ears	442
14.32	Front Rack-Ears	443
14.33	Top Cover	444
14.34	Top Card Guide	445
14.35	Motherboard Fan	446
15.	S3 Maintenance	449
15.1	S3 unit Overview	451
15.2	Process Overview	452
15.3	Spare Parts Serviceable by All Users	453
15.4	Rear I/O, Link and VPU Cards	454
15.5	Rear I/O, VPU and Link card Heatsink Fan	456
15.6	Front Cover Assembly	457
15.7	Front Brackets	460
15.8	3RU Fan Tray	461
15.9	Front Panel Knob	463
15.10	Front Panel Mount	465
15.11	Front Panel Board	466
15.12	VFD Display Assembly	468
15.13	VFD Display Filter	469
15.14	USB Cable	470
15.15	USB Extension Cable	473
15.16	Power Supply	475
15.17	Genlock Assembly	476
15.18	Rear Rack Ears	478
15.19	Front Rack-Ears	479
15.20	Top Cover	480
15.21	Top Card Guide	481
15.22	Motherboard Fan	482
15.23	Power Interposer Assembly	484
15.24	Power Supply Guide	486
15.25	Side support plate	489
15.26	Link Card Interposer	491
15.27	CPU Module	492
15.28	Solid-State Memory	494
15.29	System Battery	496
15.30	VFD Cable	497
15.31	Keyboard Cable	501
15.32	3RU Fan Cable	503
15.33	Ethernet Cable	506
15.34	Genlock Cable	508
16.	EX Maintenance	511
16.1	EX unit Overview	512
16.2	Process Overview	513
16.3	Spare Parts Serviceable by All Users	514
16.4	Event Master Cards	515
16.5	Top Cover	517
16.6	Power Supply	519
16.7	CPU Module	521
16.8	System Battery	523
16.9	Motherboard	524
16.10	Motherboard Fansink	529
17.	EC-30 Maintenance	531
17.1	Servicing	532
18.	EC-50 Maintenance	533
18.1	Servicing	534
19.	EC-200 Maintenance	537
19.1	Servicing	538
20.	Environmental information	541
20.1	Disposal information	542
20.2	RoHS compliance	543
20.3	Production address	545
A.	Specifications	547
A.1	Specifications of E2	548

A.2	Specifications of E2 Jr.	550
A.3	Specifications of S3-4K	552
A.4	Specifications of S3-4K Jr.	554
A.5	Specifications of EX	556
A.6	Specifications of EC-30	557
A.7	Specifications of EC-50	558
A.8	Specifications of EC-200	559
A.9	Specifications of standard connections	560
A.10	Standard connector pinouts	561
B.	Remote Control Protocol.	565
B.1	Event Master series processor ASCII remote control	566
B.2	Event Master series processor JSON RPC remote control	567
C.	Troubleshooting	579
C.1	Troubleshooting List	581
D.	Third Party Software Acknowledgements.	583
D.1	Third Party Software list	584
E.	Warranty	585
E.1	About Warranty and RMA	586
Index	587

1. INTRODUCTION

Overview

- About this guide
- Record of changes
- Symbols, pictures and fonts
- The 4K screen management system

1.1 About this guide

This manual

This User's guide describes how to install and operate the Event Master units (E2 and S3 series) and their controllers (EC-50 and EC-200). The User's Guide is designed to be a reference tool in the everyday work of the user with the product. It contains a complete description of the hardware components and the control software. The manual also includes all the necessary instructions on how to upgrade firmware, install spare parts and perform any hardware upgrades.



Barco provides a 3-year parts and labor warranty for all hardware components. Please refer to the Appendix B ("Warranty", page 585) for specific details regarding the warranty terms.

Available System documentation

This guide is part of the documentation set describing the Event Master products.

Guide	Article number
User Guide	R5905948
E2 Quick Start Guide	26-1205004-00
S3 Quick Start Guide	26-1401004-00
EX Quick Start Guide	26-1502004-00
EC-30 Quick Start Guide	60600356
EC-50 Quick Start Guide	60600332
EC-200 Quick Start Guide	60600333
E2 Safety Guide	R5905947
S3 series Safety Guide	R5906016
EC series Safety Guide	R5906018
EX Safety Guide	R5906020
Service Guide	R5905949 (Only available to Customer Service partners)

A printed copy of Safety Guides and Quick Start Guides is included in the shipping box of the Event Master devices. Please check online for the other documents.



Always check for the latest version of all documents on www.barco.com

1.2 Record of changes

Overview

Revision	Changes
00	Initial version
01	<ul style="list-style-type: none"> • Changes initiated by: <ul style="list-style-type: none"> - New software version (V2.0). - S3-4K and EC-50 product releases. • In the entire of the document, the references to E2 have been replaced by reference to the Event Master processors. • A record of changes (this section) has been added. • S3-4K product has been added. Chapters concerned by this new Event Master processor have been modified: <ul style="list-style-type: none"> - Description in General chapter + How to install S3 in a rack. - Detailed explanations concerning new hardware in the Hardware Orientation chapter. • EC-50 product has been added. Chapters concerned by this new controller have been modified or added: <ul style="list-style-type: none"> - Description in General chapter. - New chapters dedicated to Controller Orientation, Controller Configuration and Controller Operation. • A new version off Event Master Toolset is available (V2.0). The GUI orientation chapter and the System setup procedure have been updated. • Two units can be linked. A section in the GUI orientation chapter describes how set up a linked System. • A new chapter concerning the maintenance of the S3-4K has been added. • A new chapter concerning the maintenance of the EC-50 controller has been added. • Annex: <ul style="list-style-type: none"> - New section with S3 specifications. - Remote command ATRN updated. - New chapter "THIRD PARTY SOFTWARE ACKNOWLEDGEMENTS" added.
02	<ul style="list-style-type: none"> • Changes initiated by: <ul style="list-style-type: none"> - New software version (V3.0). - EC-200 product release. • EC-200 product has been added. Chapters concerned by this new controller have been modified or added: <ul style="list-style-type: none"> - Description in General chapter. - New chapters dedicated to Controller Orientation, Controller Configuration and Controller Operation. • The Front Panel Menu orientation chapter has been updated: <ul style="list-style-type: none"> - a modification in the front menu panel of the "Event Master Processor" to take into account a configuration created offline and transferred via USB device. • A new version off Event Master Toolset is available (V3.0). The GUI orientation chapter has been partially updated. A more complete update of this chapter will be performed at the next version of the document. <ul style="list-style-type: none"> - Win 10 has been added in the list of Operating Systems that accepts the "Event Master Toolset" Software. - A new section describes the Controller menu. • A new chapter concerning the maintenance of the EC-200 controller has been added. • Annex: <ul style="list-style-type: none"> - New short section with EC-50 specifications.
03	<ul style="list-style-type: none"> • Changes initiated by: <ul style="list-style-type: none"> - Updated RoHS table, taking into account the March 2016 changes.





Revision	Changes
04	<ul style="list-style-type: none"> • Changes initiated by new software version (V4.1). <ul style="list-style-type: none"> - “Complete” vs “Relative” Preset configuration, see "Programming Menu > Adjustment area > Presets configuration", page 210. - Destination Groups, see "Programming Menu > Adjustment area > Dest Group configuration", page 203. - Firmware upgrade for EC-200, see "EC-200 Firmware Upgrade", page 349 and "Settings Menu > Web App area > Tools > Manage Software", page 236. - Added “Backgrounds as Inputs.” Refer to "Programming Menu > Resources area", page 174, and see the “Backgrounds as Inputs” subsection., and see the “Backgrounds as Inputs” subsection. - Linking Event Master units, see "Configuration Menu > Linking", page 156. - Added MVR slot configuration. Refer to "Configuration Menu > Adjustment > Unit Configuration", page 115, and see the Description of the Setup tab.. - Updates to Output configuration and Destination configuration; refer to "Configuration Menu > Adjustment > Output Configuration", page 130 and "Configuration Menu > Adjustment > Destination Configuration", page 138. - Preset Conflict Mode: Off, see "Configuration Menu > System modifier area", page 113. - Descriptions of the subtabs in the Settings Menu, Resources area, see "Settings Menu", page 225. - Soft-Off button in the EC-200 GUI, see "How to power down the EC-200", page 350. - Split-Mode configuration, see "Configuration Menu > System diagram area", page 110. - Added JSON RPC section to the Remote Control Protocol appendix, see "Event Master series processor JSON RPC remote control", page 567.
05	<ul style="list-style-type: none"> • Changes initiated by: <ul style="list-style-type: none"> - EC-30 product release - New software version (4.2). <ul style="list-style-type: none"> ○ EX support for two VPU cards: refer to "Event Master series processors features", page 24 and see the Program screens table, and see the Specifications table in "VPU card", page 69. ○ More Configuration Menu > Linking examples: refer to "Configuration Menu > Linking", page 156 and see "How to Link an E2 Unit and two S3-4K Units" and "How to Link an S3-4K Unit and an EX Unit with two VPU cards." ○ "Basic Mode" and "Expert Mode" for Data-doubling: refer to "Configuration Menu > Adjustment > Destination Configuration", page 138 and see "Data-doubling submenu—Basic Mode" and "Data-doubling submenu—Expert Mode." ○ Pick Hue: refer to "Programming Menu > Adjustment area > Layer configuration", page 195 and see "Pick Hue." ○ Updated Complete and Relative Presets: refer to "Programming Menu > Adjustment area > Presets configuration", page 210 and see "Presets configuration menu description" and "Complete vs Relative."
06	<ul style="list-style-type: none"> • Changes initiated by software updates (versions 4.2 and 5.0): <ul style="list-style-type: none"> - Updated the procedure to create and transfer an offline configuration to a live unit: refer to "System menu > USB device (Backup/Restore)", page 80 and see How to create a configuration offline and transfer it to a live unit. - Added instructions for changing the last slot from Multiviewer (MVR) to Output and from Output to MVR: refer to "Configuration Menu > Adjustment > Unit Configuration", page 115 and see Last slot as MVR or Output in the simulator. - Updated Input, Background, and Output menu descriptions with new options: refer to "Configuration Menu > Adjustment > Input Configuration", page 117, "Configuration Menu > Adjustment > Background Configuration", page 127, and "Configuration Menu > Adjustment > Output Configuration", page 130 and see the menu descriptions. - Added Output rotation icons to the Assign Menu for Destination configuration: refer to "Configuration Menu > Adjustment > Destination Configuration", page 138 and see Assign Menu.

Revision	Changes
	<ul style="list-style-type: none"> • Changes initiated by new hardware: <ul style="list-style-type: none"> - Added description of Tri-Combo Input card: refer to "Tri-Combo Input Card", page 57. - Added "EX Maintenance", page 511. - Added "EC-30 Maintenance", page 531.
07	<ul style="list-style-type: none"> • Changes initiated by software updates (version 5.1): <ul style="list-style-type: none"> - Corrected HDCP support for the quad-channel DisplayPort output card; see "Quad Channel DisplayPort Output Card", page 60. - Added instructions and descriptions for importing a PNG with alpha channel (transparency) information preserved for Key Cut + Fill layers: refer to "Presentation System overview", page 35, "Programming Menu > Resources area", page 174, and "Programming Menu > Drop Sources, Layers into Screen Destinations & Sources into layers", page 273. - Refer to "Configuration Menu > System diagram area", page 110: updated the Diagram area image and color-code description to include the tri-combo input and output cards and split-mode on the quad-channel DisplayPort output card and the tri-combo output card. - Added instructions for creating Super Destinations: refer to "Configuration Menu > Adjustment > Destination Configuration", page 138 and also to "Programming Menu", page 173 and "Programming Menu > Adjustment area > Dest Group configuration", page 203. - Added several linking examples, covering more than two E2, S3-4K, or EX units and EX units with VPUs: refer to "Configuration Menu > Linking", page 156. - Updated the JSON listPresets API and added the 3dControl API: refer to "Event Master series processor JSON RPC remote control", page 567 and see listPresets and 3dControl. • Changes initiated by new hardware: <ul style="list-style-type: none"> - Added description of Tri-Combo Output card: refer to "Tri-Combo Output Card", page 65.

1.3 Symbols, pictures and fonts

Symbol overview

The following icons are used in the manual :

	Caution
	Warning
	Info, term definition. General info about the term
	Note: gives extra information about the described subject
	Tip: gives extra advice about the described subject

Picture overview

Images and pictures given in the manual are used as illustration. The content of the images can be slightly different with the reality, e.g. version numbers, device types, installed modules, form and position of software windows on screen ...

1.4 The 4K screen management system

The presentation systems E2 and S3–4K

Raising the bar for live screen management, the Event Master screen management system provides superior image quality, exceptional input and output density, great expandability, and purpose built durability. Supporting native 4K input and output with up to 60 Hz refresh rates and 4:4:4 color, it is the most modular system available to manage blended 4K projectors with refresh rates up to 60 Hz and full range color sampling. Being a truly versatile system, the Event Master offers a large range of scaled AUX outputs and PGM outputs for full show control with a single box.

Native 4K input and output

With native 4K input and output, the Event master devices provide impressive pixel processing power. Whether native or scaled inputs, two connectors or four, this HDCP-compliant system manages it all.

With up to 32 inputs and 14 outputs, the E2 system offers full show control, including 32 independent PIP layers, 12 outputs and a dedicated two channel Multi-viewer. Thanks to its linkable chassis, it can easily expand beyond the single chassis capacity, without the need for additional external processing and routing to distribute the signals. And as its inputs and layers can also be extended, the E2 is even capable of managing a blend of up to 32 4K projectors.

Simple servicing and control

The Event Master devices come with a straightforward cross-platform user interface that provides touchscreen ergonomics. As the presets are stored on the chassis, it enables easy control via third-party systems. Multiple users can control a system simultaneously, and the API allows third-party developers to create custom control programs and interfaces. Thanks to their modular designs, users can simply add a new input or output card to support future signal interfaces. This modularity also ensures great serviceability, as users can easily swap a specific input or output card in the case of damage, without needing to ship or replace the entire box.

Designed for life on the road

Designed for the live event industry, the rugged Event Master devices feature a steel chassis that's able to withstand the challenging conditions of life on the road. What's more, they offer screen control in a compact form factor of only four rack units (3 RU for the S3), which makes them easy to ship and install. And thanks to their modular cards and dual redundant power supplies, the Event Master devices are extremely reliable and easy to service in the field.

2. SAFETY

About this chapter

Please read this chapter carefully. It contains important information to prevent personal injury while installing and operating Event Master devices. Furthermore, it includes several cautions to prevent damage to the Event Master devices. Ensure that you understand and follow all safety guidelines, safety instructions and warnings mentioned in this chapter before you begin installation. After this chapter, additional “warnings” and “cautions” are given depending on the installation procedure. Read and follow these “warnings” and “cautions” as well.

Overview

- General considerations
- Important safety instructions

2.1 General considerations

General safety instructions

- Before operating these devices please read this manual thoroughly and retain it for future reference.
- All warnings in the documentation manual should be adhered to.
- All instructions for operating and use of these devices must be followed precisely.
- All local installation codes should be adhered to.

Notice on safety

This equipment is built in accordance with the requirements of the international safety standards IEC60950-1, EN60950-1, UL60950-1 and CAN/CSA C22.2 No.60950-1, which are the safety standards of information technology equipment including electrical business equipment. These safety standards impose important requirements on the use of safety critical components, materials and insulation, in order to protect the user or operator against risk of electric shock and energy hazard and having access to live parts. Safety standards also impose limits to the internal and external temperature rises, radiation levels, mechanical stability and strength, enclosure construction and protection against the risk of fire. Simulated single fault condition testing ensures the safety of the equipment to the user even when the equipment's normal operation fails.

2.2 Important safety instructions

To prevent risk, personal injury and Event Master devices damages

Please read this chapter carefully. It includes several cautions to prevent damage to Event Master devices. Ensure that you understand and follow all safety guidelines, safety instructions and warnings mentioned in this chapter before installing Event Master devices. After this chapter, additional “warnings” and “cautions” are given depending on the installation procedure. Read and follow these “warnings” and “cautions” as well.

- Read and follow all installation and operation instructions.
- Only trained technicians may install Event Master devices.
- Installation of Event Master devices must be done in a dust free area.
- Only use attachments/accessories specified by the manufacturer.
- **CAUTION:** Troubleshooting must be performed by a trained technician. To reduce the risk of electrical shock, do not attempt to service this equipment unless you are qualified to do so.
- Refer all servicing to qualified service personnel. Servicing is required when the system has been damaged in any way, such as liquid has been spilled or objects have fallen into the system, or the system has been exposed to rain or moisture, does not operate normally, or has been dropped.
- **FRAGILE:** Event Master devices are fragile. Handle these devices with care at all times.
- To prevent injury, minimum 2 persons are required to carry an Event Master series processor or an EC-200 controller.
- Do not remove any covers or panels during normal operation. Removal any of these items will expose sensitive electronic circuits and the unit may be damaged.
- During maintenance operations, always switch off the device and unplug power cords before removing one of the covers.
- Always wear a wrist band which is connected to the ground while handling the ESD sensitive parts.
- Wear insulating gloves during the execution of the installation and maintenance actions to avoid short-circuit.
- Be careful never to drop anything into the device assembly during the service procedures.
- Be careful to always follow the procedures during maintenance operations (spare parts replacement).
- This product is intended to operate from a power source that will not apply more than 230 volts rms between the supply conductors or between both supply conductor and ground. A protective ground connection by way of grounding conductor in the power cord is essential for safe operation.
- This product is grounded through the grounding conductor of the power cord. To avoid electrical shock, plug the power cord into a properly wired receptacle before connecting to the product input or output terminals. A protective-ground connection by way of the grounding conductor in the power cord is essential for safe operation. For 110V installations the power supply cord should be rated at 13amps. For 220V installations the power supply cord should be rated 10amps.
- Use only the power cord and connector specified for your product. Use only a power cord that is in good condition. Refer cord and connector changes to qualified service personnel.
- Replace spare parts only with the same parts supplied by Barco.
- Save the original shipping carton and packing material. They will come in handy if you ever have to ship your equipment. For maximum protection, repack your set as it was originally packed at the factory.
- Rated maximum ambient operating temperature, $t_a = 40^{\circ}\text{C}$ (104°F).
- Do not operate this product in an area containing explosive materials.

Safety Data Sheets for Hazardous Chemicals

For safe handling information on chemical products, consult the Safety Data Sheet (SDS). SDSs are available upon request via safetydatasheets@barco.com.

3. GENERAL

About this chapter

This chapter is designed to introduce you to the Event Master series products.

Overview

- Event Master devices overview
- Event Master series processors features
- Event Master controllers features
- Terms and definitions
- Control overview
- Presentation System overview
- Installation requirements
- Initial inspection
- Rack-Mount Procedure

3.1 Event Master devices overview

General

Event Master devices are the most advanced video processing and presentation control systems on the market today. These systems provide source selection, advanced windowing features, seamless switching, video effects and integrated control for professional video presentations. Thanks to their modular and scalable architecture, Event Master devices can support a wide variety of show configurations.

The Event Master series products are the following:

- E2, 4K screen management system (Event Master processor).
- E2 Jr., 4K screen management system (Event Master processor).
- EX, expansion box (Event Master processor).
- S3-4K, compact 4K screen management system (Event Master processor).
- S3-4K Jr., compact 4K screen management system (Event Master processor).
- EC-30, compact Event Master controller.
- EC-50, compact Event Master controller.
- EC-200, large Event Master controller.

About E2



Image 3-1
E2

E2 is a modular, scalable digital video processor, designed to manage multiple display destinations and large video walls. The E2 screen management system provides superior image quality and an exceptional input and output density, within a single 4RU rack mount chassis. Supporting native 4K I/O cards, it is the first and only screen management system on the market that can manage a 4K projector blend with refresh rates up to 60Hz. A truly versatile system, it offers up to 32 inputs and 14 outputs (up-to eight PGM, four Multiviewer and four scaled Aux outputs) for full show control. Multiple E2 units can be linked in order to achieve a combination of Layer, Canvas, Input and Output expansion. The control interface is performed through a GUI application running Windows, Linux* or Mac platforms. E2 covers multiple markets including Rental & Staging, Corporate AV, Simulation, Control Rooms and Broadcast.

Thanks to its modular design, users can also simply add a new input or output card to support future signal interfaces. This modularity also ensures field serviceability, as users can easily swap a specific input or output card in the case of damage or failures, without needing to ship or replace the entire box.

About E2 Jr.



Image 3-2
E2 Jr.

The E2 Jr. comes with 16 inputs, 8 outputs, and 8 mixers (or 16 single layers) in the same 4-RU form factor as its bigger brother, E2. It offers the same performance and features as the E2 offers, but it is ideally suited for applications that require more capacity than the compact S3-4K but do not require the full capacity of the E2.

E2 Jr. can use the same modular cards as E2 uses, and thanks to its modular design, the E2 Jr. can be upgraded to a fully loaded E2 system at any time.

About EX

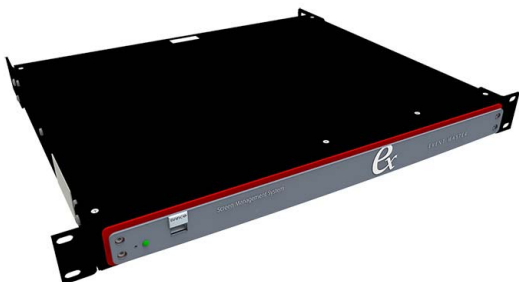

Image 3-3
EX

When linked to the Event Master system (E2 or S3-4K) it acts as an input and/or output expansion box to increase the capacities available to the system. Via the link cable, a fiber extension can be used to extend the distance between the EX and the E2 or S3 processor. EX allows the user to place the unit close to a large concentration of sources or outputs (for example, on a stage with demo computers) and use a single cable to deliver the signals to and from the main processor. EX helps reduce the cost in terms of equipment and labor hours required to set up an event.

The Ex can also be used as a stand-alone unit to scale, switch, and convert video signals to multiple displays. As a stand-alone unit it can be thought of as a 4x4 scaling matrix.

EX can use the same modular cards as E2 uses.

About S3-4K



Image 3-4
S3

Featuring 12 input channels, 4 PROGRAM outputs, 4 AUX outputs and 2 dedicated Multiviewer outputs, the S3-4K screen management system is a compact version of the E2. Smaller (only 3RU rack mount chassis), its operation is similar to that the E2, and it is operated in the same manner.

S3 and E2 use the same modular cards.

About S3-4K Jr.



Image 3-5
S3-4K Jr.

The S3-4K Jr comes with 8 inputs, 4 outputs, and 2 mixers in the same 3 RU form factor as its bigger brother, the S3-4K. It offers the same performance and features as the S3-4K offers, but it is ideally suited for applications that do not require the full capacity of the S3-4K.

S3-4K Jr. can use the same modular cards as E2 uses, and you can upgrade the S3-4K Jr. to a fully loaded S3-4K system at any time; simply purchase and install additional cards into your system.

About EC-30



Image 3-6
EC-30

The EC-30—the most compact version of the EC-series Event Master controllers—provides instant access to the most crucial features for everything from a tradeshow booth to a large corporate event, even a music tour. The EC-30 offers a compact surface, simplified workflow, and fingertip control where budget and space are the deciding factors. As an extension of the Event Master toolset, the EC-30 gives you essential selections for sources, presets, layers, and destinations. As a USB peripheral added to your existing Event Master control computer, the EC-30 is the most cost effective and compact alternative to a full sized controller.

About EC-50



Image 3-7
EC-50

The Event Master EC-50 event controller delivers instant access and great situational awareness for everything from trade show booths to large corporate events and even music tours. Its small footprint makes it suitable for most control environments, while simultaneously packing all the power and durability needed for instant access to crucial functions. As an extension of the Event Master toolset and the EC-200, the EC-50 brings sources, presets, layers, and destination selection at your fingertips, along with another, touch enabled display.

About EC-200



Image 3-8
EC-200

The Event Master EC-200 event controller is a dedicated hardware console specifically designed to support the Event Master Series Processors and devices. Based on an industrial operating system with optimized hardware, it runs the Event Master ToolSet software. Recommended for small events as well as for stadium sized shows, it provides the same functionality as its accessory, the EC-50 controller, with additional features and capabilities delivered in a compact package. The tactile operation style of the EC-200 with buttons and touch screens gives the operator plenty of programming room in a effective layout. Expandable with its large choice of connectivity, the controller can support additional external Event Master compatible devices over USB, Network and USB. EC-200 is the infrastructure that will keep you in control of Barco Event Master Series Devices, now and in the future.

3.2 Event Master series processors features

Inputs

Model	E2	E2 Jr.	S3-4K	S3-4K Jr.	EX
Input cards	8x	4x	3x	2x	2x

Each card accommodates either 4x HD inputs, 2x 2560 x 1600 inputs, or 1x 4K input.

The EX expansion box does not ship with cards; cards must be purchased separately. Each EX expansion box has two general purpose card slots, each of which may support any E2 input or output card.

Card type	Connector Type
HDMI/DisplayPort input card	2x HDMI 1.4 connectors 2x DisplayPort 1.1 connectors
Dual Link DVI input card	2x Dual Link DVI-D connectors
SDI input card	4x BNC connector supporting 6G-SDI
Note: Event Master currently supports up to 3G-SDI formats. 6G-SDI may be supported in a future software release.	
Genlock input	2x BNC connector (Input and loop output) Supports black burst* and tri-level analog signals



*** All processors support black burst input; EX uses a regenerated genlock output and does not support black burst output.**

Depending on the model, each Event Master processor is shipped with the following input cards:

Model	Inputs via input cards
E2	<ul style="list-style-type: none"> • 28 inputs via 8 Event Master series input cards: <ul style="list-style-type: none"> - Up to 8x 4K inputs – each output card supports up to 4K@60p out - 8x SD/HD/3G SDI (6G ready) - 8x HDMI 1.4 (297 Mpix/sec max) - 8x DisplayPort 1.1 (300 Mpix/sec max) - 4x Dual Link DVI (330 Mpix/sec max)
E2Jr.	<ul style="list-style-type: none"> • 16 inputs via 4 Event Master series input cards: <ul style="list-style-type: none"> - Up to 4x 4K inputs – each output card supports up to 4K@60p out - 4x SD/HD/3G SDI (6G ready) - 6x HDMI 1.4 (297 Mpix/sec max) - 6x DisplayPort 1.1 (300 Mpix/sec max)
S3-4K	<ul style="list-style-type: none"> • 12 inputs via 3 Event Master series input cards: <ul style="list-style-type: none"> - Up to 3x 4K inputs – each output card supports up to 4K@60p out - 4x SD/HD/3G SDI (6G ready) - 4x HDMI 1.4 (297 Mpix/sec max) - 4x DisplayPort 1.1 (300 Mpix/sec max)
S3-4K Jr.	<ul style="list-style-type: none"> • 8 inputs via 2 Event Master series input cards: <ul style="list-style-type: none"> - Up to 2x 4K inputs – each output card supports up to 4K@60p out - 4x SD/HD/3G SDI (6G ready) - 2x HDMI 1.4 (297 Mpix/sec max) - 2x DisplayPort 1.1 (300 Mpix/sec max)
EX	<ul style="list-style-type: none"> • Two card slots, each of which may support any E2 input or output card <ul style="list-style-type: none"> - Up to 8 inputs via 2 input cards or 8 outputs via 2 output cards (same cards as E2 Event Master processor) (4 inputs and 4 outputs, using one card of each type) - Inputs can be distributed to other processors via the link cable or to a locally installed output card.

Outputs

Model	E2	E2 Jr.	S3-4K	S3-4K Jr.	EX
Output card slots	3x	3x	2x	2x	2x
Multiviewer card slots	1x	1x	1x	1x	NA

The last slot on E2 and E2 Jr. (Slot #14) and on S3-4K and S3-4K Jr. (Slot #9) may be designated as either a Multiviewer (MVR) card slot or as an Output card slot. See "Configuration Menu > Adjustment > Unit Configuration", page 115 for more details.

Card type	Connector Type
DisplayPort output card	4x DisplayPort 1.2 connectors
HDMI output card	4x HDMI 1.4 connectors
SDI output card	4x BNC connector supporting 6G-SDI
Note: Event Master currently supports up to 3G-SDI formats. 6G-SDI may be supported in a future software release.	
HDMI Multi-viewer card	4x HDMI 1.4 connectors

The EX expansion box does not ship with cards; cards must be purchased separately. Each EX expansion box has two general purpose cards slots, each of which may support any E2 input or output card.

Depending on the model, each Event Master processor is shipped with the following output cards:

Model	Outputs via output cards	Program outputs
E2	<ul style="list-style-type: none"> 14 outputs via 4 output cards: <ul style="list-style-type: none"> Up to 3x 4K outputs – each output card supports up to 4K@60p out 4x SD/HD/3G SDI (6G ready) 8x HDMI 1.4a (297 Mpix/sec max) 2x HDMI 1.4a for Multiviewer (297 Mpix/sec max) 	<ul style="list-style-type: none"> Twelve (12) program outputs configurable as single screens or tiled/blended widescreens <ul style="list-style-type: none"> Configurable from 8x 2048 × 1200@60 max to 2x 4096× 2400@60 max Independent edge blending/feathering control for all four sides Unused outputs may be used as scaled auxiliary outputs.
E2 Jr.	<ul style="list-style-type: none"> 10 outputs via 3 output cards: <ul style="list-style-type: none"> Up to 2x 4K outputs – each output card supports up to 4K@60p out 4x SD/HD/3G SDI (6G ready) 4x HDMI 1.4a (297 Mpix/sec max) 2x HDMI 1.4a for Multiviewer (297 Mpix/sec max) 	<ul style="list-style-type: none"> Four (4) program outputs configurable as single screens or tiled/blended widescreens <ul style="list-style-type: none"> Configurable from 4x 2048 × 1200@60 max to 1x 4096× 2400@60 max Independent edge blending/feathering control for all four sides Unused outputs may be used as scaled auxiliary outputs.
S3-4K	<ul style="list-style-type: none"> 10 outputs via 3 output cards: (same cards as E2 Event Master processor) <ul style="list-style-type: none"> Up to 2x 4K outputs – each output card supports up to 4K@60p out 4x SD/HD/3G SDI (6G ready) 4x HDMI 1.4a (297 Mpix/sec max) 2x HDMI 1.4a for Multiviewer (297 Mpix/sec max) 	<ul style="list-style-type: none"> Four (4) program outputs configurable as single screens or tiled/blended widescreens <ul style="list-style-type: none"> Configurable from 4x 2048 × 1200@60 max to 1x 4096× 2400@60 max Independent edge blending/feathering control for all four sides Unused outputs may be used as scaled auxiliary outputs.
S3-4K Jr.	<ul style="list-style-type: none"> 6 outputs via 2 output cards: <ul style="list-style-type: none"> Up to 2x 4K outputs – each output card supports up to 4K@60p out 4x HDMI 1.4a (297 Mpix/sec max) 2x HDMI 1.4a for Multiviewer (297 Mpix/sec max) Up to 1x 4K output 	<ul style="list-style-type: none"> Four (4) program outputs configurable as single screens or tiled/blended widescreens <ul style="list-style-type: none"> Configurable from 4x 2048 × 1200@60 max to 1x 4096× 2400@60 max Independent edge blending/feathering control for all four sides
EX	<ul style="list-style-type: none"> Two card slots, each of which may support any E2 input or output card <ul style="list-style-type: none"> Up to 8 outputs via the 2 output cards (same cards as E2 Event Master processor) Sources for the outputs can be from remote systems via the link connection or from a locally installed input card. 	<ul style="list-style-type: none"> Up to 8 program outputs for destinations created in a linked E2 or S3-4K processor. <ul style="list-style-type: none"> Unused outputs may be used as scaled auxiliary outputs.

3. General

An EX expansion box supports screen-destination program outputs and auxiliary outputs, up to a maximum total of eight (8) video links (destinations or inputs) from main processor on a link cable to another expansion box.

User interface

User interface	Details
Event Master Software	GUI based configuration and control application Cross platform (Mac/Windows)
Event Master Console EC-50 and EC-200	Dedicated hardware panels specifically designed to support Event Master processors

Processing and latency

- 12 bits/color
- 36 bits/pixel
- 1 frame processing latency for progressive sources

PIP layers (per chassis)

Up to 32 PIP or Key overlay layers:

Model	PIP layers
E2	<ul style="list-style-type: none"> • 2K mode: 32x seamless PIP or Key overlay • DL mode: 16x seamless PIP or Key overlay • 4K mode: 8x seamless PIP or Key overlay
E2 Jr.	<ul style="list-style-type: none"> • 2K mode: 16x seamless PIP or Key overlay • DL mode: 8x seamless PIP or Key overlay • 4K mode: 4x seamless PIP or Key overlay
S3-4K	<ul style="list-style-type: none"> • 2K mode: 8x seamless PIP or Key overlay • DL mode: 4x seamless PIP or Key overlay • 4K mode: 2x seamless PIP or Key overlay
S3-4K Jr.	<ul style="list-style-type: none"> • 2K mode: 4x seamless PIP or Key overlay • DL mode: 2x seamless PIP or Key overlay • 4K mode: 1x seamless PIP or Key overlay
EX	NA

Background mixer

Each PGM screen destination has an unscaled seamless background mixer supporting the full resolution of the destination

- Any live input type can be a background source
- Matte color generator
- Still store as background

Destinations (single chassis)

Model	Destinations
E2	Eight (8) Program Outputs configurable as single screens or tiled/blended widescreens.
E2 Jr.	Four (4) Program Outputs configurable as single screens or tiled/blended widescreens.
S3-4K	Four (4) Program Outputs configurable as single screens or tiled/blended widescreens.
S3-4K Jr.	Four (4) Program Outputs configurable as single screens or tiled/blended widescreens.
EX	NA

Program screens

Model	Layout Mode		
	Max. number of 4K outputs	Max. number of Dual-Link outputs	Max. number of HD (2K) outputs
E2	<ul style="list-style-type: none"> • 2x single screens • 1x blended (2 outputs) 	<ul style="list-style-type: none"> • 4x single screens • 2x blended 	<ul style="list-style-type: none"> • 8x single screens • 4x 2 output blended (2 output per blend) up to 8x 1 output blended

Layout Mode			
Model	Max. number of 4K outputs	Max. number of Dual-Link outputs	Max. number of HD (2K) outputs
E2 Jr.	<ul style="list-style-type: none"> 2x single screens 1x single screen (Has only one VPU bank; does not support 4K blending.) 	<ul style="list-style-type: none"> 4x single screens 2x blended 	<ul style="list-style-type: none"> 8x single screens 2x 2 output blended (2 output per blend) up to 4x 1 output blended
S3-4K	<ul style="list-style-type: none"> 1x single screens 	<ul style="list-style-type: none"> 2x single screens 1x blended 	<ul style="list-style-type: none"> 4x single screens 2x 2 output blended (2 output per blend) up to 4x 1 output blended
S3-4K Jr.	<ul style="list-style-type: none"> 1x single screens 	<ul style="list-style-type: none"> 2x single screens 1x blended 	<ul style="list-style-type: none"> 4x single screens 2x 2 output blended (2 output per blend) up to 4x 1 output blended
EX	<ul style="list-style-type: none"> 2x single screens 1x blended (2 outputs) 	<ul style="list-style-type: none"> 4x single screens 2x blended 	<ul style="list-style-type: none"> 8x single screens 4x 2 output blended (2 output per blend) up to 8x 1 output blended

The EX expansion box can have a combination of Input and Output cards, or it can have two VPU cards.

Auxiliary Outputs

Model	Auxiliary Outputs
E2	User definable from 12x 2048 x 1200 at 60 Hz to 3x 4K at 60 Hz
E2 Jr.	User definable from 8x 2048 x 1200 at 60 Hz to 2x 4K at 60 Hz
S3-4K	User definable from 8x 2048 x 1200 at 60 Hz to 2x 4K at 60 Hz
S3-4K Jr.	User definable from 4x 2048 x 1200 at 60 Hz to 1x 4K at 60 Hz
EX	User definable from 8x 2048 x 1200 at 60 Hz to 2x 4K at 60 Hz

Layer Mode			
Model	Max. number of 4K outputs	Max. number of Dual-Link outputs	Max. number of HD (2K) outputs
E2	<ul style="list-style-type: none"> 3x Scaled AUX output 	<ul style="list-style-type: none"> 6x Scaled AUX output 	<ul style="list-style-type: none"> 12x Scaled AUX output
E2 Jr.	<ul style="list-style-type: none"> 2x Scaled AUX output 	<ul style="list-style-type: none"> 4x Scaled AUX output 	<ul style="list-style-type: none"> 8x Scaled AUX output
S3-4K	<ul style="list-style-type: none"> 2x Scaled AUX output 	<ul style="list-style-type: none"> 4x Scaled AUX output 	<ul style="list-style-type: none"> 8x Scaled AUX output
S3-4K Jr.	<ul style="list-style-type: none"> 1x Scaled AUX output 	<ul style="list-style-type: none"> 2x Scaled AUX output 	<ul style="list-style-type: none"> 4x Scaled AUX output
EX	<ul style="list-style-type: none"> 2x Scaled AUX output 	<ul style="list-style-type: none"> 4x Scaled AUX output 	<ul style="list-style-type: none"> 8x Scaled AUX output

Multi-viewer

Output Resolution	Max. Number of Outputs
HD (2K) output	<ul style="list-style-type: none"> 2x Multi-viewer output

Still stores

User-assigned still stores

- Live capture
- Loaded via PNG file

Presets

1,000 user definable presets

Expandability

Model	Chassis per system
E2	2 chassis per system—2x E2s, E2 & S3-4K, or E2 & 8x EX
E2 Jr.	Linking is available as an upgrade option.
S3-4K	2 chassis per system—2x S3-4Ks, S3-4K & E2, or S3-4K & 4x EX

3. General

Model	Chassis per system
S3-4K Jr.	Linking is available as an upgrade option.
EX	2 Ex chassis can be linked for standalone operation, or an EX can be linked to either an E2 or an S3-4K.

Expansion Program Screens			
Model	Max. number of 4K outputs	Max. number of Dual-Link outputs	Max. number of HD (2K) outputs
E2	4 outputs	8 outputs	16 outputs
E2 Jr.	NA ¹	NA ¹	NA ¹
S3-4K	2 outputs	4 outputs	8 outputs
S3-4K Jr.	NA ¹	NA ¹	NA ¹
EX	2 outputs	4 outputs	8 outputs

¹ The E2 Jr. and the S3-4K Jr. do not support linking, although linking is available as an upgrade option for these models.

Chassis

E2 and E2 Jr.	S3-4k and S3-4k Jr.	EX
<ul style="list-style-type: none"> • 4RU • Dual Redundant PSU • Modular field swappable processing and I/O cards • Variable flow cooling • Rugged steel chassis 	<ul style="list-style-type: none"> • 3RU • Dual Redundant PSU¹ • Modular field swappable processing and I/O cards • Variable flow cooling • Rugged steel chassis 	<ul style="list-style-type: none"> • 1RU • Rugged steel chassis • Modular field swap • Variable flow cooling

¹ The S3-4K Jr. comes with a single power supply; the redundant power supply is optional.

3.3 Event Master controllers features

Connectivity

EC-30	EC-50	EC-200
USB connection from Event Master Toolset host computer (OSX or Windows 7 and higher)	USB connection from Event Master Toolset, either from a control computer or the EC-200 controller	<ul style="list-style-type: none"> 4 USB connectors in the back can be used for keyboard and mouse and other supported USB devices. 1 USB connector in the middle of the top of the console is on delivery fitted with a USB memory.
NA	DVI input for touchscreen monitor	2 connectors DVI-D (Screen output 1 and 2, internally 3 and 4)
NA	NA	2 Ethernet connectors (outlet 1 to your Event Master Device Network for static IP address and outlet 2 for a DHCP assigned IP address)

User controls

EC-30	EC-50	EC-200
<ul style="list-style-type: none"> 24 assignable buttons with customizable LCD displays 8 dedicated Layer selection buttons and dedicated Background Layer button 12 user definable Destination buttons with multi-page functionality 2 User Assignable Contextual Display buttons 1 Cut button 1 All Trans button High-resolution T-Bar 	<ul style="list-style-type: none"> 36 assignable buttons with customizable LCD displays 8 dedicated Layer selection buttons and dedicated Background Layer button 12 user-definable Destination buttons with multi-page functionality 4 User Assignable Contextual Display buttons 1 Cut button 1 All Trans button High-resolution T-Bar 1x Internal 15.6-inch wide touch screen 	<ul style="list-style-type: none"> 36 assignable buttons with customizable LCD displays 8 dedicated Layer selection buttons and dedicated Background Layer button 12 user-definable Destination buttons with multi-page functionality 4 User Assignable Contextual Display buttons 1 Cut button 2 All Trans buttons 1 On Screen Keyboard Button 1 Console Lock Button 1 Save All Button High-resolution T-Bar with enable/disable button 1 System Function Button Group 1 Direct Selection Button Group 1 Syntax Entry Button Group 1 Numpad 1 Contextual Display Button Group 1 Live Function Button Group 1 Arrow Button Group 1 Trackball with 4 modifier buttons 2 Barco Eye Buttons 5 Rotary Encoders referred to as wheels with modifier buttons 1 Future Expansion Button Group 2x Internal 15.6-inch wide touch screen

Dimensions and weight

	EC-30	EC-50	EC-200
Dimensions (HxWxD)	105.4 x 465.6 x 321.0 mm 4.15 x 18.33 x 12.63 inches	244.34 x 511.56 x 610.0 mm 9.62 x 20.14 x 24.0 inches	244.34 x 901.19 x 610.0 mm 9.62 x 35.49 x 24.0 inches
Weight	3.18 kg (7 lbs.)	12.33 kg (27.2 lbs.)	20.41kg (45 lbs.)
Screen	NA	1x Internal 15.6-inch wide touch screen with 10 point multi-touch	2x Internal 15.6-inch wide touch screens with 10 point multi-touch

3. General

Other

EC-30	EC-50	EC-200
<ul style="list-style-type: none">• USB port for connection to host computer• Status LEDs and color coded LCD displays• Auto-ranging 12v, 2.08a power supply (100-250 VAC)	<ul style="list-style-type: none">• 1x work light (flexible support)• 2x flexible ribbon LED (backlight in front face and back face)• Auto-ranging mains input (90-250 VAC)	<ul style="list-style-type: none">• 2x work lights (flexible support)• 2x flexible ribbon LED (backlight in front face and back face)• Auto-ranging mains input (90-250 VAC)

3.4 Terms and definitions

3G

A 3 Gbit/s serial digital 10-bit or 12-bit video interface (SMPTE 424M and 425M).

AUX (auxiliary Output)

A video output that can show any source and seamlessly cut between them.

Background (BG)

Typically an unscaled source originating from a computer's multi-head graphics card, or a frame grab from a scaled source. An Event Master processor can use any input signal and assign it as a Background source, provided it is at the same resolution as is the destination. The Background appears at the system's lowest layer priority and does not use any system scaler resources.

Chroma Key

A type of key where the hole-cutting information is derived from a color rather than from a video level. A common example on television, is when the weatherman appears to be standing in front of a map. The map itself is a video signal, and the weatherman is in fact standing in front of a green (or blue) screen. On the switcher, the Chroma Key process electronically subtracts the color from the foreground image, and replaces it with video from the background image to form a composite image.

Clip, Gain, Opacity

In switcher terminology, the process of fine-tuning a key of any type (luminance, linear, or chroma). Clipping sets the threshold for the hole cutting circuitry, while "gain" defines the range and sensitivity of adjustment. The "opacity" is the transparency or density of the key, as revealed over a background.

Colorspace

All video signals have a colorspace. Versions are RGB, YUV or YrYbYc. They also have a range like 16 -240 = Reduced or Full 0-254.

There is also a color processing scheme that allow bandwidth saving. Full would be 4:4:4 and versions include 4:2:2 and 4:2:0

Computer Video

A generic term indicating video that originates from a computer platform. A progressive scan signal that follows VESA (Video Electronics Standards Association) standards, with typical resolutions of 800 x 600, 1920 x 1080, UHD and 4K etc.

Crosspoint

Traditionally the button that selects the input required on a particular switcher bus. But in Event Master device the actual backbone of the processors who routes the internal video signals.

Cut

Cut is an instantaneous switch from one video source to another.

DA (Distribution Amplifier)

A video device that inputs one video signal, and outputs multiple "identical" signals.

Destination (DST)

A Destination is a location to which you can route the output of an Event Master device. A destination can be configured as a group of one or more outputs that feed the same screen.

A Destination can be a single, widescreen or multi-screen Mixing Layers are assigned to Destinations.

A Destination can transition Backgrounds and Mixing Layers.

Event Master Control Software (EM GUI)

This user's guide refers to the Event Master control software as the EM GUI. The software consists of several menus and tabs that enable you to configure your system, setup the input sources and output Destinations, manage the dedicated Multiviewer and create your presentation's overall "look." Refer to the chapter "EM GUI orientation", page 97 for more information about the EM GUI.

Event Master Series Processor (EMP)

Any Event Master series processor—E2, E2 Jr., S3-4K, S3-4K Jr., or EX—may be referred to as an EMP.

Event Master Toolset Software (EMTS)

Event Master Toolset Software is an easy to use GUI running on a PC or MAC. It provides all the Event Master series processors with control and configuration.

Fader

See **T-Bar**.

GUI (Graphical User Interface)

A term that describes a status display based on graphics and icons, rather than strictly on numbers and letters.

Input

The actual input connector of a processor.

Key

An electronic (and visual) process whereby one image is electronically superimposed over another source or background. Keys are typically used for titles, logos, and banners.

Keyframe

In a PIP "move," a keyframe is a point where an action or change occurs. For example, when a PIP moves from the upper right corner to full screen, keyframe 1 is the upper right position, and keyframe 2 is the full screen position of the PIP.

Key Fill

The video which fills the hole cut by the keying circuitry. Typically, switchers provide a variety of choices for the fill source — internal mattes, external video, or "self" fill are several examples.

Key Mask

A key modification system that protects a portion of the foreground video from being keyed, using the switcher's internal pattern system.

Key Signal

Also known as **Key Source**. The signal that electronically cuts the hole in the background video signal. Key signals typically originate from external inputs such as character generators or cameras.

Layer

An image display element (such as a PIP, Key or Background) that has an associated visual priority — either in front (or in back) of another layer.

Linear Key

Linear key is a keying mode in which the edges of anti-aliased key sources (such as character generators) are reproduced clearly. Typically, two separate signals are required from a linear key source: a cut and a fill.

Menu

A term used to describe buttons and functions on the high-resolution color LCD touch screen.

Mix

Also known as a **Dissolve**. A transition between two video sources in which one source fades out as the other fades in.

Mixer

Circuitry that enables you to transition (and scale) PIPs and Keys over a background.

MVR (Multiviewer)

A video output that previews sources, backgrounds, destinations and Auxiliaries in scaled down windows with a border and a text.

NTSC

National Television Standards Committee. The oldest standard for color picture broadcasting. NTSC is a standard definition format that operates at a frequency of 60Hz, with 525 lines, 60 fields and 30 frames per second.

PAL

Phase Alternating Line. PAL is the NTSC equivalent TV standard in Europe. PAL is a standard definition format that operates at a frequency of 50Hz, with 625 lines, 50 fields, and 25 frames per second.

PGM (Program)

The switcher's main output signal.

PIP

Picture-in-Picture, an on-screen configuration in which one picture (typically of reduced size) is positioned over another background image — or another PIP. PIPs can be reduced, enlarged, bordered, shadowed, and mixed on and off Program. PIPs can overlap each other, depending on their visual priority. In E2, the multiviewer PIPs are not allowed to overlap.

Preset

Storage register in which you can store (and recall) the entire configuration or “look” of your destination(s).

PVW (Preview)

The video that will appear next on program (main) outputs.

RGB

The red, green and blue color signal components.

Scaler

An electronic circuit that reduces or enlarges source images, thus creating PIPs and Keys that can be positioned (and transitioned).

SDI (Serial Digital Video)

SD / HD / 3G / 6G-SDI is a digital representation of the video signal that is distributed via a single coaxial cable with BNC connectors. (SMPTE 259M / 274M/ 296M /424M). Example formats are 480i and 525i.

Source file

The adjusted and saved file that describes the settings for the processor to use.

System

A Event Master system is all processors and devices included in one configuration of the control software.

T-Bar

Also known as a Fader, the T-Bar is the lever on a switcher that manually controls the progress of an effect. The position of the fader controls the amount of the BG (Background) Bus signal and the PVW (Preview) Bus signal that contributes to the mix, wipe or key.

Wipe

A Wipe is a transition between two video sources that uses a selected pattern to determine the edge between the two sources.

Z-order

All layers of a Event Master Processor will have its layers in a z-order. Typically with is BG as the lowest.

3.5 Control overview

General

There are several ways to control Event Master Series Processors.

Settings and Diagnostics:

- **Front Panel.**
- **Web interface** running directly from an Event Master series processor.

Operational Set up and Programming:

- **Event Master Toolset** running on a Windows 7 PC or Apple Mac with OSX.
- **EventMaster Controller EC-50 or EC-200.**

Remote recall and non-Barco device connectivity:

- **External serial protocol** connected devices like PreSetManager.

Not all of these do the same thing, below the immediate differences. Several of these all work at the same time, providing multiple points of control.

Front Panel

The Event Master series processor front panel includes a power switch, a USB port and a dimmable display that works in conjunction with the ADJUST knob and SEL and ESC buttons. Through the front panel menus you can perform basic system functions such as factory reset, set network parameters and basic diagnostics. A front-panel USB port is provided for downloading and restoring logo images and system configurations. Refer to the chapter "Front panel", page 44 for more information about the about the Event Master Series processor front panel menus.

Web interface

Via the local network and a computer the user can access a web page server running on Event Master series processor. Basic system functions similar to the ones available from the front panel menus are accessible through the web page server. Refer to the chapter "Settings Menu", page 225 for more information about the Event Master Series Web interface.

Event Master Toolset (EMTS)

Event Master Toolset Software is an easy to use GUI running on a PC or MAC. It provides all the Event Master Series of product with control and configuration.

The software consists of several menus and tabs that enable you to configure your system, setup the input sources and output destinations, manage the dedicated multiviewer and create your presentation's overall "look".

In addition, since the configuration parameters and presets are stored on the Event Master processor unit, multiple instances of the GUI can be run simultaneously on different computers expanding the control possibilities.

Refer to the chapter "EM GUI orientation", page 97 for more information about the GUI. Subsequently in this User's Guide, the Event Master Control Software will be referred as the EM GUI.

Event Master Controller

The Event Master Controllers are dedicated hardware consoles specifically designed to support the Event Master Series Processors, devices and systems created from several of them.

It runs from the same software as the Event Master ToolSet, but EC-200 on an industrial operating system with optimized hardware. All of them includes tactile operation style with buttons and touch screen displays allowing for easy and direct control.

Rudimentary Preset recall protocol for a single Processor is the same as for earlier products like Encore TM and FSN Production Switching system.

An API based on JSON (*JavaScript Object Notation*) is available for developers who need to create custom control programs and interfaces.

3.6 Presentation System overview

Advanced video processing

The Event Master processors are the most advanced video processing and presentation control systems on the market today. These systems provide source selection, windowing, seamless switching, video effects and integrated control for professional presentations. The modular and scalable architecture of the Event Master processors allow support for a wide variety of show configurations.

A word about Layers

A layer is an image display element stacked on top of another or a background. Within the Event Master processor, each mixer has two layers, **A** and **B**, and one **Background** layer. For complete flexibility, each layer can be assigned to either **PIP** or **Key** functionality.

The **Background** layer has the lowest priority. Any input or inputs can be used as a background. This layer visually appears behind all other PIPs and keys. The system can transition between two background sources.

PIP layer appears over backgrounds and under other layers of higher priority. PIP effects include mixes, smooth moves, resizing, adjustable aspect ratio, borders and drop shadows.

Key layer also appears over backgrounds and under other layers of higher priority. Key effects include luminance keys, split keys (key alpha or fill), invert keys and chroma keys.



Image 3-9

A word about Destinations

Destination is a location where the user assigns the outputs.

We can consider three destination types:

- Single/Multiple Screen Destination (e.g. one or more projectors)
- AUX Destination (e.g. a monitor dedicated for camera adjustments)

There are several rules that apply when defining an Destination configuration. For details on destination setup procedures, please refer to the chapter "Configuration Menu > Adjustment > Destination Configuration", page 138.

3.7 Installation requirements

Environment conditions

Table below summarizes the physical environment in which the Event Master devices and their controllers may be safely operated or stored.

Environment	Operating	Non-Operating
Ambient Temperature	0°C (32°F) to 40°C (104°F)	-10°C (14°F) to 60°C (140°F)
Air cleanliness	Clean office environment (equivalent with cleanroom standard ISO 14644-1 ISO Class 9)	n.a.
Humidity	5% to 85% RH Non-condensed	0% to 95% RH Non-Condensed
Altitude	-60 (-197Ft) to 3000m (9843Ft)	-60 (-197Ft) to 10000m (32810Ft)



CAUTION: Let the Event Master devices and their controllers acclimate to the ambient temperature after unpacking. Ensure that the humidity is within the specification. Neglecting this may result in startup failure of these devices.

Software package

This version of the User's Guide is based on software version 03.00.00.



Verify that the Event Master device is loaded with the latest software version available on the Barco web site (URL: <https://www.barco.com/>). Refer to the chapter "Updating firmware", page 279 for more information about the device upgrading software.

Event Master Toolset Software (EM GUI)

The EM GUI software must be at least:

- Version 03.00.00

3.8 Initial inspection

General

Before shipment, all the devices were inspected and found to be free of mechanical and electrical defects. As soon as the devices are unpacked, inspect for any damage that may have occurred in transit. Save all packing material until the inspection is completed. If damage is found, file claim with carrier immediately. The Barco Sales and the Service office should be notified as soon as possible.

Unpacking

At delivery, Event Master devices are packed in a shipping case. Place the shipping case of the device on a stable (solid), flat and insulated support during all the unpacking. Open the case from the top. Remove the device that is packaged in an antistatic bag. Check the box content after unpacking.



After unpacking let the device acclimate to the room temperature which must be higher than 0°C (32°F) and lower than 40°C (104°F). Neglecting this may result in startup failure of the device.



Save the original shipping case and packing material, these will be necessary if you ever have to ship your device. For maximum protection, repack your device as it was originally packed at the factory.



When shipping an E2 in a Barco-supplied case, make sure that the rear connector protectors are installed to prevent damage.

Box content

After unpacking an Event Master device, it is recommended that it be checked to see if all accessories were included.

Depending on the product, the following accessories should be included.

Product	Contains	Accessories included
R9004698 (E2)	<ul style="list-style-type: none"> • 4RU rack mount chassis • 2x 14-9750004-90 • 2x B1959864 • 2x B1959865 • 2x B1959860 • 2x 09-0106032-91 • 8x 13-0081012-90 • 2x 09-0106031-90 • B561132 • R5905947 • 26-1205004-00 	<ul style="list-style-type: none"> • E2 assembly • European Power Cord CEE7 (not included with units shipped to China) • US Power Cord NEMA 5/15 (not included with units shipped to China) • China Power Cord GB 2099 (included only with units shipped to China) • CXP Expansion Link Cables • Rear Rack Mount Support Plates • 8-32 x .38 Pan Head Screws for Rear Rack Mount Support Plates • Rear Rack Mount Brackets • USB Thumb Drive (Contains Users Guide, System Software and Control GUI) • Safety manual • Quick Start Guide
R9004777 (E2 Jr.)	<ul style="list-style-type: none"> • 4RU rack mount chassis • 2x 14-9750004-90 • 2x B1959864 • 2x B1959865 • 2x 09-0106032-91 • 8x 13-0081012—90 • 2x 09-0106031-90 • B561132 • R5905947 • 26-1205004-00 	<ul style="list-style-type: none"> • E2 Jr. assembly • European Power Cord CEE7 (not included with units shipped to China) • US Power Cord NEMA 5/15 (not included with units shipped to China) • China Power Cord GB 2099 (included only with units shipped to China) • Rear Rack Mount Support Plates • 8-32 x .38 Pan Head Screws for Rear Rack Mount Support Plates • Rear Rack Mount Brackets • USB Thumb Drive (Contains Users Guide, System Software and Control GUI) • Safety manual • Quick Start Guide

3. General

Product	Contains	Accessories included
R9004757 (S3-4K)	<ul style="list-style-type: none"> 3RU rack mount chassis 2x 14-9750004-90 2x B1959864 2x B1959865 1x B1959860 2x 09-0106032-91 8x 13-0081012-90 2x 09-0106031-90 B561132 R5906016 26-1401004-00 	<ul style="list-style-type: none"> S3 assembly European Power Cord CEE7 (not included with units shipped to China) US Power Cord NEMA 5/15 (not included with units shipped to China) China Power Cord GB 2099 (included only with units shipped to China) CXP Expansion Link Cables Rear Rack Mount Support Plates 8-32 x .38 Pan Head Screws for Rear Rack Mount Support Plates Rear Rack Mount Brackets USB Thumb Drive (Contains Users Guide, System Software and Control GUI) Safety manual Quick Start Guide
R9004778 (S3-4K Jr.)	<ul style="list-style-type: none"> 3RU rack mount chassis 1x 14-9750004-90 1x B1959864 1x B1959865 2x 09-0106032-91 8x 13-0081012-90 2x 09-0106031-90 B561132 R5906016 26-1401004-00 	<ul style="list-style-type: none"> S3 assembly European Power Cord CEE7 (not included with units shipped to China) US Power Cord NEMA 5/15 (not included with units shipped to China) China Power Cord GB 2099 (included only with units shipped to China) Rear Rack Mount Support Plates 8-32 x .38 Pan Head Screws for Rear Rack Mount Support Plates Rear Rack Mount Brackets USB Thumb Drive (Contains Users Guide, System Software and Control GUI) Safety manual Quick Start Guide
R9004776 (EX)	<ul style="list-style-type: none"> 1RU rack mount chassis 1x 14-9750004-90 1x B1959864 1x B1959865 1x R9871179 2x 09-0904021-90 4x 13-0211010-90 B561132 R5906020 	<ul style="list-style-type: none"> EX assembly European Power Cord CEE7 (not included with units shipped to China) US Power Cord NEMA 5/15 (not included with units shipped to China) China Power Cord GB 2099 (included only with units shipped to China) Rear Rack Mount Support Kit, includes brackets, side support plates, screws, and washers Rear Connector Protectors 8-32 x .38 Pan Head Screws for rear connector protectors (x2 per protector) USB Thumb Drive (Contains Users Guide, System Software and Control GUI) Safety manual
R9004783 (EC-30)	<ul style="list-style-type: none"> EC controller 1x 90803038EF 1x 14-9750004-90 1x B1959865 1x 99070037EF 1x R9080003 1x 90409546EF B561132 R5906018 60600356 	<ul style="list-style-type: none"> EC-30 assembly US Power Cord NEMA 5/15 (not included with units shipped to China) European Power Cord CEE7 (not included with units shipped to China) China Power Cord GB 2099 (included only with units shipped to China) Power supply (25W, 12V) Dust Cover USB Type A to Type B Cable USB Thumb Drive (Contains Users Guide, System Software and Control GUI) Safety manual Quick Start Guide
R9004772 (EC-50)	<ul style="list-style-type: none"> EC controller 1x 90803038EF 1x 14-9750004-90 1x B1959865 1x 61100005 1x R9080001 1x 90409546EF 1x 90409545EF B561132 R5906018 60600332 	<ul style="list-style-type: none"> EC-50 assembly US Power Cord NEMA 5/15 (not included with units shipped to China) European Power Cord CEE7 (not included with units shipped to China) China Power Cord GB 2099 (included only with units shipped to China) Desk Light Dust Cover USB Type A to Type B Cable DVI-D to DVI-D Cable USB Thumb Drive (Contains Users Guide, System Software and Control GUI) Safety manual Quick Start Guide
R9004771	<ul style="list-style-type: none"> EC controller 	<ul style="list-style-type: none"> EC-200 assembly

Product	Contains	Accessories included
(EC-200)	<ul style="list-style-type: none"> • 1x 90803038EF • 1x 14-9750004-90 • 1x B1959865 • 2x 61100005 • 1x R9080002 • 1x B561132 • R5906018 • 60600333 	<ul style="list-style-type: none"> • US Power Cord NEMA 5/15 (not included with units shipped to China) • European Power Cord CEE7 (not included with units shipped to China) • China Power Cord GB 2099 (included only with units shipped to China) • Desk Light • Dust Cover • USB Thumb Drive (Contains Users Guide, System Software and Control GUI) • Safety manual • Quick Start Guide

Mechanical check

This check should confirm that there are no broken parts and the unit is free of dents or scratches. Your Barco Sales representative should be notified as soon as possible if this is not the case.

3.9 Rack-Mount Procedure

General

The chassis of the Event master devices (E2 and S3 series) are designed to be rack mounted. The devices are supplied with front rackmount hardware.

Please note the following important points:

- The E2 is 4RU in height while the S3 is 3RU in height.
- The maximum ambient operating temperature is 40 degrees C.
- Leave sufficient front and rear space to ensure that airflow through the unit is not restricted.
- When installing equipment into a rack, distribute the units evenly to prevent hazardous conditions that may be created by uneven weight distribution.
- Connect the unit only to a properly rated supply circuit.
- Reliable grounding (earthing) of rack-mounted equipment should be maintained.
- Rack mount the unit from the front rack ears using four rack screws (not supplied). Threads may be metric or otherwise, depending upon the rack type.



Rack-mount procedure is different depending the Event master device type (E2 or S3).



CAUTION: At a minimum, an E2 chassis weighs 31 kg (68 lbs) and a S3 chassis weighs 24 kg (53 lbs). To avoid injury, it is recommended that two people rack mount these chassis.

How to install E2 in a rack

Use the following steps to rack mount the E2:

1. The E2 is shipped with side rails included in the shipping case and not installed onto the chassis. These side rails, when they are properly installed and adjusted, assist with the distribution of chassis (and cable) weight within your rack. Use the following steps to properly adjust the side rails:
 - a) Measure and install the two supplied mounting brackets on your rear rack rails.



Image 3-10

- b) Measure the distance between the front and rear rack rails. Remove the four mounting screws that secure each side rail to the E2, and then adjust the spacing of each side rail as necessary.

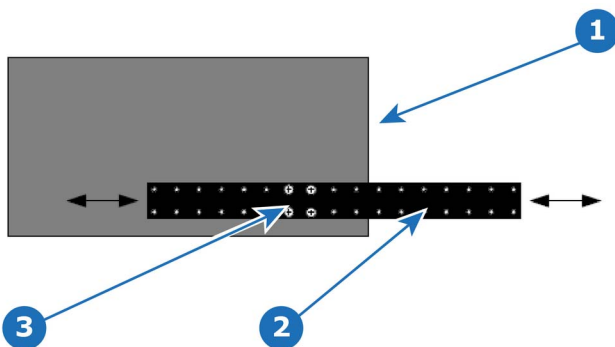

Image 3-11

- 1 Chassis rear
- 2 Side rail
- 3 Mounting screws

- c) Re-install the mounting screws. When properly adjusted, the end of each side rail will protrude through the slot in the rear mounting bracket, once the chassis is rack mounted.

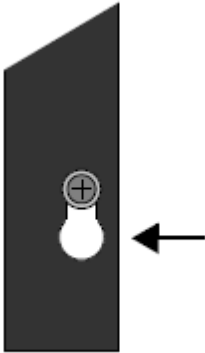

Image 3-12

To take advantage of this feature, ensure that there is at least 1/2" of clearance above the chassis.

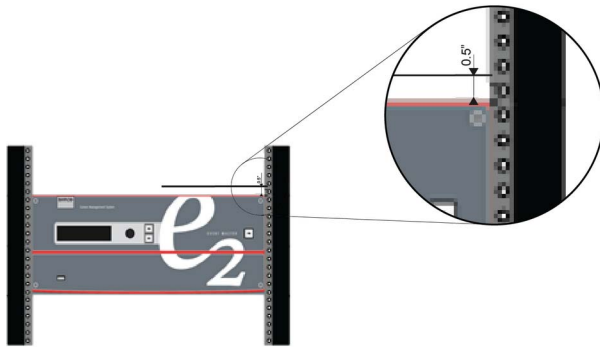

Image 3-13

2. For the E2's two keyhole slots, measure and install two rack screws in your equipment rack's front rails. Allow each screw to protrude approximately 3/4" from the surface of the rails.
3. Lift the chassis, and while supporting it, slide the side rails through the slots in the rear mounting brackets.
4. While continuing to support the chassis, slide the screws (in the front rails) through the two keyholes, and let the chassis settle up into the keyhole slots.
5. Tighten the two lower screws, then install and tighten the two upper screws in the rack rail.

How to install S3 or EX in a rack

Use the following steps to rack mount the S3 or the EX:

1. S3 and EX units are shipped with side rails included in the shipping case and not installed onto the chassis. These side rails, when they are properly installed and adjusted, assist with the distribution of chassis (and cable) weight within your rack. Use the following steps to properly adjust the side rails:
 - a) Measure and install the two supplied mounting brackets on your rear rack rails.



Image 3-14

3. General

- b) Measure the distance between the front and rear rack rails. Remove the mounting screws that secure each side rail to the chassis, and then adjust the spacing of each side rail as necessary. The S3 uses four mounting screws on each side rail; the EX uses two mounting screws on each side rail.

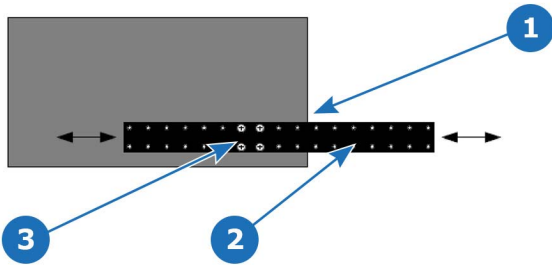

Image 3-15
S3-4K series side rail and mounting screws

- 1 Chassis rear
- 2 Side rail
- 3 Mounting screws

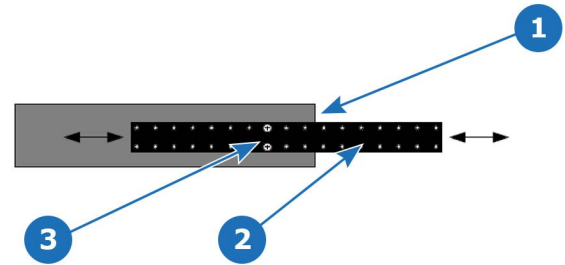

Image 3-16
EX expansion box side rail and mounting screws

- 1 Chassis rear
- 2 Side rail
- 3 Mounting screws

- c) Re-install the mounting screws. When properly adjusted, the end of each side rail will protrude through the slot in the rear mounting bracket, once the chassis is rack mounted.
2. Lift the chassis, and while supporting it, slide the side rails through the slots in the rear mounting brackets.
 3. While continuing to support the chassis, install and tighten the two lower screws.
 4. Finally, install and tighten the two uppers screws in the rack rail.

4. HARDWARE ORIENTATION

About this chapter

This chapter explains the Event Master series processors hardware in detail.

Overview

- Front panel
- Rear panel
- SDI Input Card
- Dual Link DVI Input Card
- HDMI/DisplayPort Input Card
- Tri-Combo Input Card
- Quad Channel DisplayPort Output Card
- HDMI Output Card
- SDI Output Card
- Tri-Combo Output Card
- Expansion Link card
- VPU card

4.1 Front panel

About front panel

See image 4-1 for an illustration of the front panel of Event Master E2 (and E2 Jr.) and S3-4K (and S3-4K Jr.) series processors. See image 4-2 for an illustration of the front panel of the Event Master EX processor.

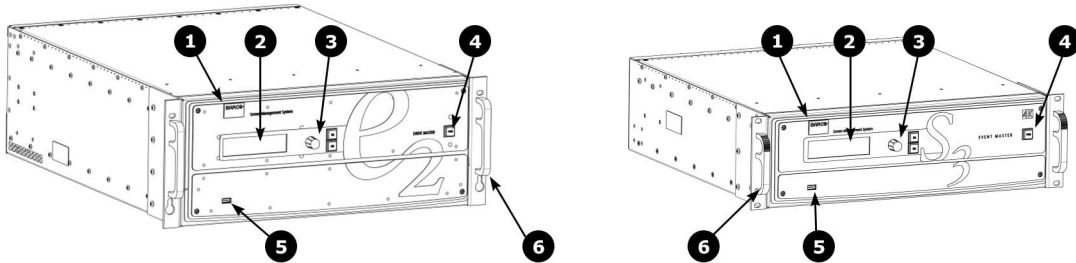

Image 4-1
E2 and S3 series front panel

- 1 Chassis handles
- 2 Barco logo
- 3 Display screen
- 4 Menu navigation buttons
- 5 Power ON/OFF button
- 6 USB port

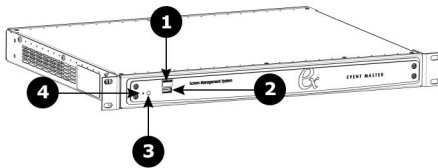

Image 4-2
EX front panel

- 1 Barco logo
- 2 USB 2.0 port
- 3 Power light
- 4 Recessed reset switch

Chassis Handles

Two Chassis Handles are provided for ease of installation and transportation.



When transporting the chassis by its handles, do not set it down with the rear connectors towards the ground. If you do, you may damage the rear connectors.

Display screen

The 4-line x 24-character screen shows all Event Master processors menus, sub-menus, and messages. The display is dimmable.

At system startup, or when no menu buttons are selected, the screen displays the **Status** Menu. The following illustration shows a sample **Status** Menu. For information about the contents of this menu, refer to the chapter titled "Front Panel Menu orientation", page 71.

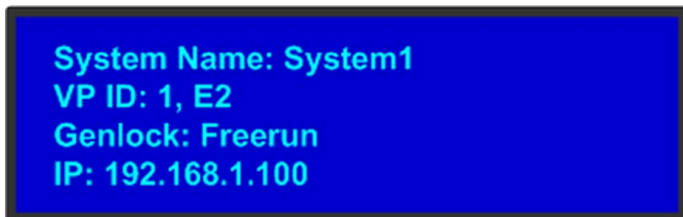

Image 4-3
e.g. E2 display screen.

Menu navigation controls

The navigation in the menus is assumed by three controls:



- Turn the ADJUST knob to scroll through the menu items on the screen.
 - Turn the knob counter-clockwise to scroll down.
 - Turn the knob clockwise to scroll up.

A navigation cursor (>) to the left of a menu item indicates the position of the scroll bar, as shown in the following illustration.

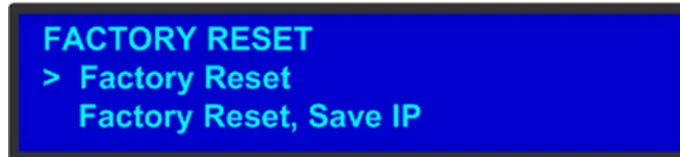

Image 4-4



- Press the SEL button to:
 - Enter the **Setup** Menu tree from the **Status** Menu
 - Select the menu item indicated by the navigation cursor
 - Change or accept a parameter
 - Answer **Yes** to menu queries



- Press the ESC button to exit a menu without making changes, to cancel an operation, to answer **No** to menu queries, or to return to the **Status** Menu. Each press takes you back up the menu tree one level.

Power ON/OFF button

This button switches the unit on and off.

USB port

The USB port is provided to support uploading and downloading system configurations and upgrading Event Master series processors firmware.

4.2 Rear panel

About rear panel

See image 4-5 for an illustration of the rear panels of the Event Master E2 and S3-4K series processors. See image 4-6 for an illustration of the rear panels of the Event Master E2 Jr. and S3-4K Jr. series processors. See image 4-7 for an illustration of the rear panel of the Event Master EX processor.

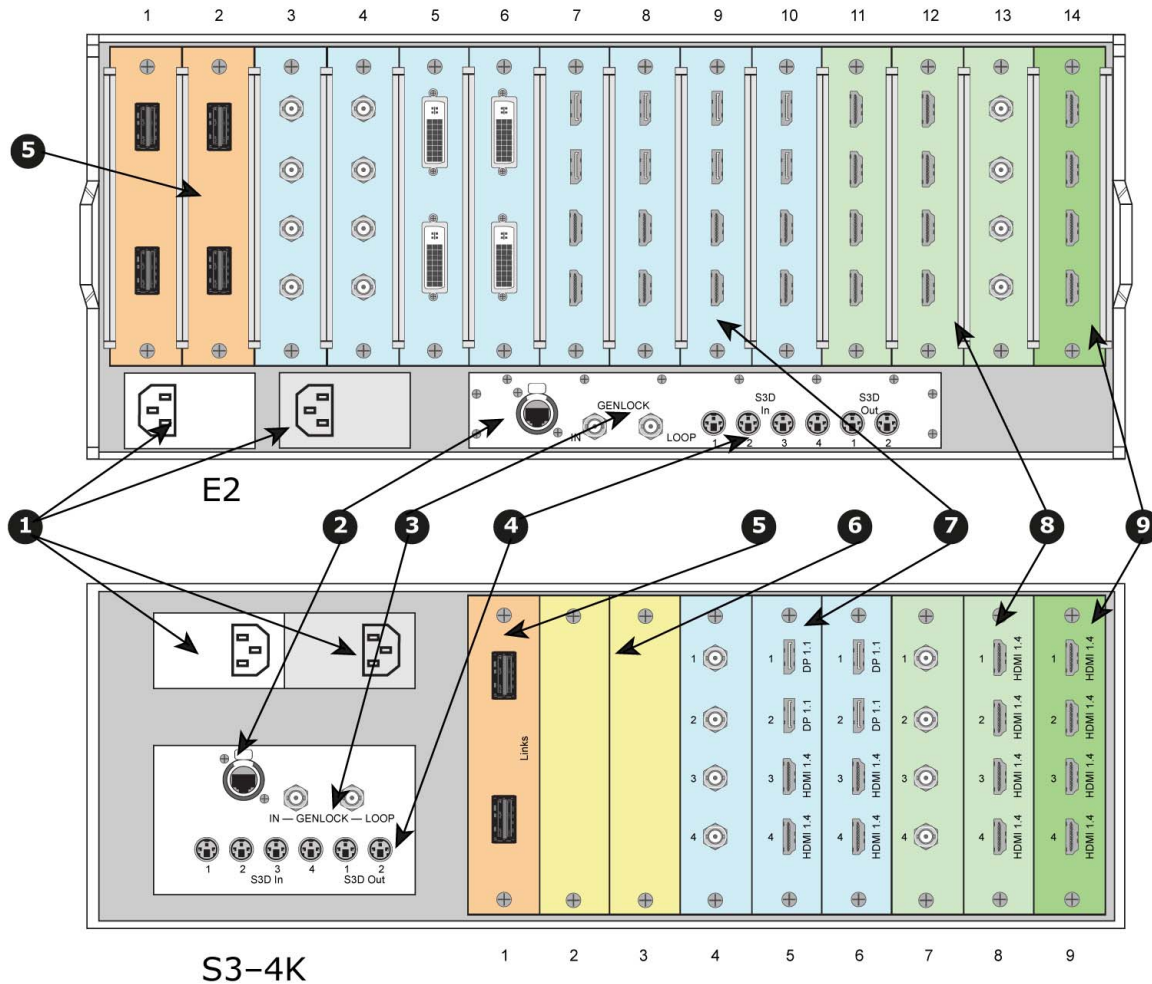

Image 4-5
E2 and S3-4K series rear panels

- 1 AC connectors
- 2 RJ-45 connector for 10/100 BaseT Ethernet communications
- 3 Genlock Input BNC with passive Loop-through
- 4 S3D In and S3D Out
- 5 Expansion Link cards
- 6 VPU cards
- 7 Input cards (HDMI/DP, SDI, DVI)
- 8 Outputs cards (DVI, SDI)
- 9 Multiviewer card (HDMI)

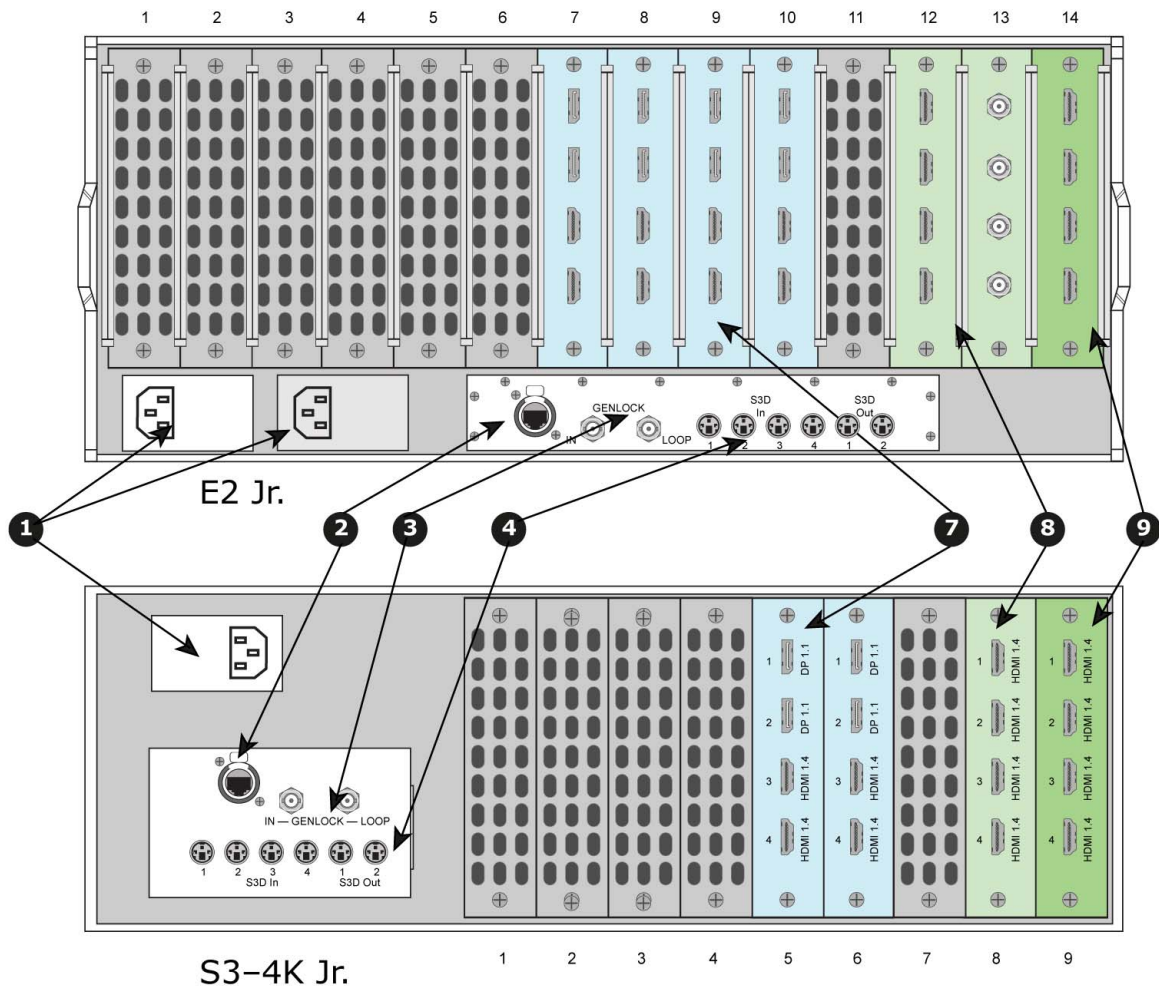

Image 4-6
E2 Jr. and S3-4K Jr. series rear panels

- 1 AC connectors
- 2 RJ-45 connector for 10/100 BaseT Ethernet communications
- 3 Genlock Input BNC with passive Loop-through
- 4 S3D In and S3D Out
-
-
- 7 Input cards (HDMI/DP, SDI, DVI)
- 8 Outputs cards (DVI, SDI)
- 9 Multiviewer card (HDMI)



The S3-4K Jr. comes with a single power supply; a redundant power supply is optional.

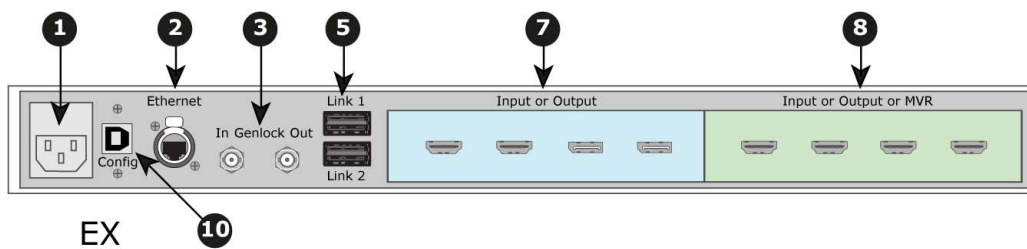

Image 4-7
EX rear panel

- 1 AC connector
- 2 RJ-45 connector for 10/100 BaseT Ethernet communications

4. Hardware orientation

3	Genlock BNC Input and Output
–	–
5	Expansion Links
–	–
7	Input cards (HDMI/DP, SDI, DVI)
8	Outputs cards (DVI, SDI)
8	Multiviewer card (HDMI)
–	–
10	USB 2.0 port



The EX image in image 4-7 is an example only. The EX expansion box does not ship with cards; cards must be purchased separately.

Description	E2	E2 Jr.	S3-4K	S3-4K Jr.	EX
1 AC connectors	2	2	2	1	1
2 RJ-45 connector for 10/100 BaseT Ethernet communications	1	1	1	1	1
3 Genlock Input BNC with passive Loop-through	2	2	2	2	NA ¹
4 S3D In and S3D Out	4 In, 2 Out	4 In, 2 Out	4 In, 2 Out	4 In, 2 Out	NA
5 Expansion Link cards	2	NA ²	1	NA ²	NA ³
6 VPU cards	NA	NA	2	1	NA
7 Input cards (HDMI/DP, SDI, DVI)	8	4	3	2	≤ 2 ⁴
8 Outputs cards (DVI, SDI)	4	3	3	2	≤ 2 ⁴
9 Multiviewer card (HDMI)	1	1	1	1	≤ 1 ⁴
10 USB 2.0 port	NA	NA	NA	NA	1

Table 4-2
Comparison of Event Master rear-panel connections



- ¹ The EX expansion box internally generates genlock output.
- ² E2 Jr. and S3-4K Jr. do not have expansion Link cards.
- ³ The EX has two (2) Expansion Links integrated in the chassis.
- ⁴ Each EX expansion box has two general purpose card slots, each of which may support any E2 input or output card.

AC connectors

Event Master E2, E2 J., S3-4K, and S3-4K Jr. series processors are equipped with two redundant power supplies. During normal operation the load is shared equally by both supplies. If one supply fails, the second carries the whole load. Two AC Connector are provided to connect Event Master series processors to your facility's AC power source through the supplied power cords.

Input Power Specification: 100-240 VAC, 47-63 Hz

On each power supply there are 3 LED lights that provide status information as follows:

- DC Output Power LED: when Green, the supply is outputting valid DC power.
- Status LED: when amber indicates that an error has occurred.
- AC Input Power LED: when green it indicates that the supply is connected to a valid AC power.

Therefore, during normal operating conditions, the input AC and Output DC LEDs will turn green.



Note that the power supplies are installed upside down in the E2 model, so the silkscreen markings will also appear upside down. Power supplies in the S3 model are installed in the correct orientation for reading silkscreen markings.

Ethernet port

One RJ-45 connector is provided for 10/100BaseT Ethernet communications with the Event Master series processor. The port is used for running the Web Interface and for connection to an external device.

The Ethernet connector is compatible with:

- Standard RJ-45 Ethernet cables
- Neutrik EtherCon® series cables

For pinout details, refer to the section dedicated to the pinout in Appendix A, "Standard connector pinouts", page 561.

Genlock Input BNC (with passive Loop-through)

The Genlock input supports analog NTSC and PAL Blackburst, as well as HD tri-level sync signals, per SMPTE 274M and SMPTE 296M. The passive loop-through connector passes the Genlock signal to another device downstream of the Event Master series processor. The Loop-through output will continue to function even when the device is turned off. When the device is genlocked and the lock source is lost, the output of the unit will automatically switch to "free-run" state without any discernible "glitching" on the output display device. As the loop-thru is passive a 75Ohm termination is necessary for stable operation.

For Genlock connections details, refer to the Specifications Appendix.

Expansion Link cards

When event requirements exceed the capacity of a single unit in terms of input, output, or number of layers, multiple Event Master processors can be linked together through the Expansion Link cards. The cards are connected with Barco-supplied, high-bandwidth, bi-directional Expansion Link cables. These cables are also commercially available.

Depending on the Event Master processor model, two, one, or no slots are reserved at left side of the rear panel for Expansion Link cards.

E2	E2 Jr.	S3-4K	S3-4K Jr.	EX
1, 2	NA ¹	1	NA ¹	NA ²



¹ E2 Jr. and S3-4K Jr. do not have Link cards, but these models can be upgraded with Link cards, which would go into the same slots as the Link cards on the E2 and the S3-4K.

² The EX has two (2) Expansion Links integrated in the chassis.

For more details on capabilities of expansion, refer to the section "Expansion Link card", page 68.

VPU cards

VPU (Video Processing Unit) cards are at the heart of the Event Master Series of products. All scaling, layer effects and image compositing happens within these cards. Each card supports the scaling requirements for the product line with the award-winning Athena scaling technology at resolutions up to 4K. Due to their reprogrammability any future video processing capabilities will be implemented in these cards. Current capabilities include:

- Support for 2K, Dual-Link, and 4K Scaling
- Layer compositing over unscaled Backgrounds
- Layer effects, including Borders and Shadows
- Keying effects
- Key frame effects

On an E2 and E2 Jr. units, the VPU cards are not accessible through the rear panel. On S3-4K and S3-4K Jr. units, slots 2 and 3 are reserved for the VPU cards. The EX expansion box has no VPU cards.

For more details on VPU card, refer to the section "VPU card", page 69.

Input cards

Each input card supports resolutions of up to 4K. The ability of the Event Master processors to support up to 28 inputs (E2) eliminates, in most cases, the need to have upstream routers or scalars.

Each card slot could accommodate either:

- 4x up-to HD/2K inputs
- 2x 2560x1600 inputs
- 1x 4K input

On an E2 (or an E2 Jr.) processor, slots 3 through 10 are reserved for input cards. On an S3-4K (or an S3-4K Jr.) processor, slots 4 through 6 are reserved for input cards. Both slots of an EX expansion box may hold input cards, but if the EX has both an input and an output card, the input card should go in slot 1.

The following sections describe each type of card in detail:

- "SDI Input Card", page 51
- "Dual Link DVI Input Card", page 53
- "HDMI/DisplayPort Input Card", page 55

Outputs cards

Event Master series processors support HDMI and SDI output cards. Each output card supports resolutions of up to 4K.

On an E2 (or an E2 Jr.) processor, slots 11 through 13 are reserved for output cards. On an S3-4K (or an S3-4K Jr.) processor, slots 7 and 8 are reserved for output cards. Both slots of an EX expansion box may hold output cards, but if the EX has both an input and an output card, the output card should go in slot 2.

The following sections describe each type of card in detail:

- "HDMI Output Card", page 62
- "SDI Output Card", page 63

Multiviewer (MVR) card

The Multiviewer card is physically identical to the HDMI output card, but when it's plugged in the last slot it operates as a Multiviewer (MVR), supporting two (2) HD outputs. The Multiviewer card is a dedicated, fully integrated monitoring solution that allows multiple displays to be shown together on a single display. Up to 63 MVR windows (sources, backgrounds, clock, or destinations) can be displayed across two (2) outputs: 63 windows for Inputs and 63 windows for Outputs.

From the Multiviewer menu in the EM GUI the user can select from predefined layouts, or create customized layouts, texts, backgrounds, borders, or colors for the monitors. The MVR includes several alarms such as Frozen and Loss-of-Signal indicators. For more details on Multiviewer features, refer to the section "Multiviewer (MVR) Menu", page 216.

4.3 SDI Input Card

General

This card provides 4 BNC connectors supporting Single Link SD, HD, and 3G-SD inputs, as well as Ultra HD (UHD) formats as Quad Link HD and 3G-SDI input.

The figure below illustrates the SDI Input card's rear panel connectors:

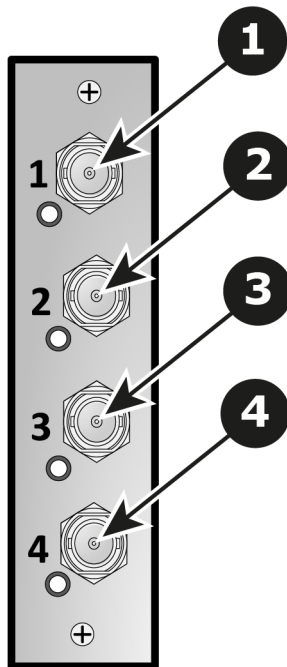

Image 4-8
SDI Input Card Rear Panel

- | | |
|---|---|
| 1 | BNC connector — SDI 1 with an LED that turns on green when a valid sync has been detected |
| 2 | BNC connector — SDI 2 with an LED that turns on green when a valid sync has been detected |
| 3 | BNC connector — SDI 3 with an LED that turns on green when a valid sync has been detected |
| 4 | BNC connector — SDI 4 with an LED that turns on green when a valid sync has been detected |

Features

- Provides up to 4 independent signals
- Automatic SD, HD, and 3G SDI Switching
- Single Link SD/ HD/ 3G SDI Input
- Quad Link UHD input as 4x HD/ 3G-SDI Input
- Each input channel includes an LED that turns green when a valid sync is detected.

Specifications

- Supported format:

Signal type	Min. BNC connector number	Max channels per card	Standard	Examples
SD	1	4	SMPTE 259M-C	480i, 576i (NTSC/PAL)
HD	1	4	SMPTE 292M	1920x1080 @ 59.94i/50i 1920x1080psf @ 23.98/24/25/29.97/30 720x480 @ 60p/50p
3G	1	4	SMPTE 424M Barcolink	1920x1080 @ 60p/50p 1920x1200 @ 60p/50p
4K / UHD	4	1	SMPTE 292M SMPTE 2048-2	Image mapping: Quadrants 3840x2160 @ 23.98/24/25/29.97/30 as 4x HD-SDI 4096x2160 @ 23.98/24/25/29.97/30 as 4x HD-SDI
4K / UHD	4	1	SMPTE 424M SMPTE 2048-2	Image mapping: Quadrants 3840x2160 @ 50/59.94/60 as 4x 3G-SDI 4096x2160 @ 50/59.94/60 60 as 4x 3G-SDI Level A and B supported
4K / UHD	4	1	SMPTE ST 425-5	Image mapping: 2 Sample Interleave Subdivision (2SI) 3840x2160 @ 23.98/24/25/29.97/30 as 4x HD-SDI 4096x2160 @ 23.98/24/25/29.97/30 as 4x HD-SDI 3840x2160 @ 50/59.94/60 as 4x 3G-SDI 4096x2160 @ 50/59.94/60 60 as 4x 3G-SDI Level A and B supported



SDI

Serial Digital Interface (SDI) is a serial link standardized by the Society of Motion Picture and Television Engineers (SMPTE). SDI transmits uncompressed digital video over 75-ohm coaxial cable within studios, and is seen on most professional video infrastructure equipment.

4.4 Dual Link DVI Input Card

General

The dual link DVI input card includes two DVI-I dual-link connectors that can support a single or dual-link DVI video signal.



Although the DVI-I connectors includes pins that support analog signals, the DVI card doesn't support analog signals. If you need to connect an analog signal to the unit, you need to employ an external A/D converter.

The figure below illustrates the dual link DVI input card's rear panel connectors:

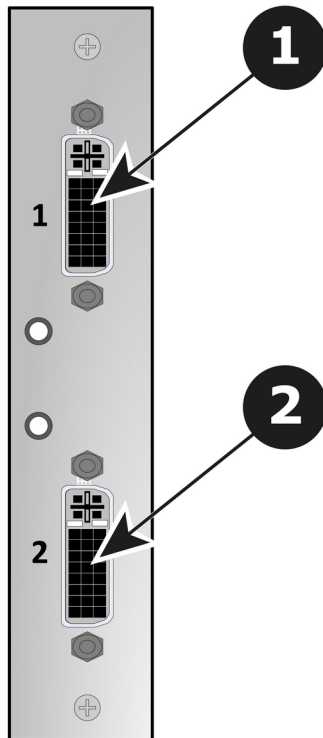

Image 4-9
Dual Link DVI Input Card Rear Panel

- | | |
|---|---|
| 1 | DVI-I dual-link connector — DVI 1 with an LED that turns on green when a valid sync has been detected |
| 2 | DVI-I dual-link connector — DVI 2 with an LED that turns on green when a valid sync has been detected |

Features

- Process up to 2 signals independently
- 2x DVI-I dual-link connector
- Support for single or dual-link DVI video signal
- Each input channel includes an LED that turns green when a valid sync is detected.

Specifications

- DVI 1.0 Specification
- Maximum H Active: 4,096, Maximum V Active: 3,072
- Supported format:
 - All single link DVI formats up to 165 MHz
 - All dual link DVI formats up to 330 MHz
 - 4K/UHD Supported:
 - 3,840x2,160/ 23.98/24/25/29.97/30 input via 1x DVIDL, 2x DVISL (L and R half) or 4x DVISL (quadrants)
 - 3,840x2,160/ 50/59.94/60 input via 2x DVIDL (L and R half) or 4x DVISL (quadrants)
 - 4,096x2,160/ 23.98/24/25/29.97/30 input via 2x DVISL (L and R half) or 4x DVISL (quadrants)
 - 4,096x2,160/ 50/59.94/60 input via 2x DVIDL (L and R half) or 4x DVISL (quadrants)
 - 4,096x2,400/ 23.98/24/25/29.97/30 input via 2x DVISL (L and R half) or 4x DVISL (quadrants)
 - 4,096x2,400/ 50/59.94/60 input via 2x DVIDL (L & R half) or 4x DVISL (quadrants)
 - EDID version 1.3 compatible
 - HDCP version 1.4 compatible



DVI

Digital Visual Interface is a display interface developed in response to the proliferation of digital flat panel displays.

The digital video connectivity standard that was developed by DDWG (Digital Display Work Group). This connection standard offers two different connectors: one with 24 pins that handles digital video signals only, and one with 29 pins that handles both digital and analog video. This standard uses TMDS (Transition Minimized Differential Signal) from Silicon Image and DDC (Display Data Channel) from VESA (Video Electronics Standards Association).

DVI can be single or dual link.

4.5 HDMI/DisplayPort Input Card

General

The HDMI/DisplayPort input card has two 19-pin HDMI connectors which can support an HDMI video signal, and two 20-pin DisplayPort connectors supporting DisplayPort video signal.

The figure below illustrates the HDMI/DisplayPort input card's rear panel connectors:

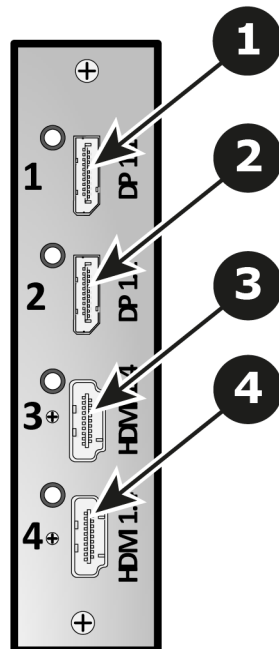

Image 4-10
HDMI/DisplayPort Input Card Rear Panel

- | | |
|---|---|
| 1 | Displayport connector — Displayport 1 with an LED that turns on green when a valid sync has been detected |
| 2 | Displayport connector — Displayport 2 with an LED that turns on green when a valid sync has been detected |
| 3 | HDMI connector — HDMI 1 with an LED that turns on green when a valid sync has been detected |
| 4 | HDMI connector — HDMI 2 with an LED that turns on green when a valid sync has been detected |

Features

- Process up to 4 signals independently
- 2x 19-pin HDMI connector (Type A)
- 2x 20-pin Displayport connector
- Each input channel includes an LED that turns green when a valid sync is detected.

HDMI specifications

- HDMI per 1.4a specifications
- Supported format:
 - formats up to 2,560x1,600@60 and 3,840x1,200@60 (30 bits)
 - 4K/UHD Supported:
 - o 3,840x2,160/ 23.98/24/25/29.97/30 input via 1x HDMI, 2x HDMI (L and R half) or 4x HDMI (quadrants)
 - o 3,840x2,160/ 50/59.94/60 input via 2x HDMI (L and R half) or 4x HDMI (quadrants)
 - o 4,096x2,160/ 23.98/24/25/29.97/30 input via 1x HDMI, 2x HDMI (L and R half) or 4x HDMI (quadrants)
 - o 4,096x2,160/ 50/59.94/60 input via 2x HDMI (L and R half) or 4x HDMI (quadrants)
- EDID version 1.3 compatible
- HDCP version 1.4 compatible

DisplayPort specifications

- DisplayPort per 1.1a specifications
- Supported format:
 - formats up to 2,560x1,600@60 and 3,840x1,200@60 (30 bits)
 - 4K/UHD Supported:
 - 3,840x2,160/ 23.98/24/25/29.97/30 via 1x DP, 2x DP (L and R half) or 4x DP (quadrants)
 - 3,840x2,160/ 50/59.94/60 via 2x DP (L and R half) or 4x DP (quadrants)
 - 4,096x2,160/ 23.98/24/25/29.97/30 via 2x DP (L and R half) or 4x DP (quadrants)
 - 4,096x2,160/ 50/59.94/60 via 2x DP (L and R half) or 4x DP (quadrants)
- EDID version 1.3 compatible
- HDCP version 1.3 compatible



HDMI

HDMI (High-Definition Multimedia Interface) is a compact audio/video interface for transferring uncompressed video data and compressed/uncompressed digital audio data from a HDMI-compliant device ("the source device") to a compatible computer monitor, video projector, digital television, or digital audio device. HDMI is a digital replacement for existing analog video standards.



DisplayPort

Digital display interface developed by the Video Electronics Standards Association (VESA). This royalty-free interface is primarily used to connect a video source to a display device such as a computer monitor, though it can also be used to transmit audio, USB, and other forms of data. VESA designed it to replace VGA, DVI, and FPD-Link. Backward compatibility to VGA and DVI by using active adapter dongles enables users to use DisplayPort fitted video sources without replacing existing display devices.

4.6 Tri-Combo Input Card

General

This card provides one 20-pin DisplayPort connector, supporting DisplayPort video signal; one 19-pin HDMI connector, supporting an HDMI video signal; and 4 BNC connectors, supporting Single Link, Dual Link, and Quad Link signals, in SD, HD, 3G, 6G, and 12G SDI formats.

The figure below illustrates the tri-combo input card's rear panel connectors:

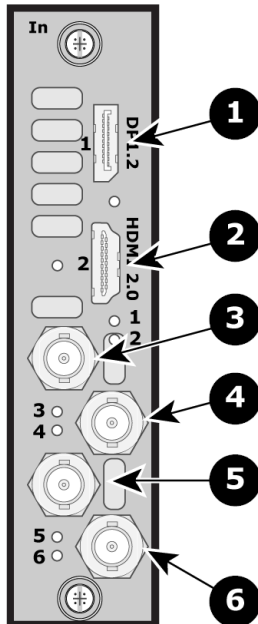

Image 4-11
Tri-Combo Input Card Rear Panel

- | | |
|---|---|
| 1 | DP connector — with an LED that turns on green when a valid sync has been detected |
| 2 | HDMI connector — with an LED that turns on green when a valid sync has been detected |
| 3 | BNC connector — SDI 1 with an LED that turns on green when a valid sync has been detected |
| 4 | BNC connector — SDI 2 with an LED that turns on green when a valid sync has been detected |
| 5 | BNC connector — SDI 3 with an LED that turns on green when a valid sync has been detected |
| 6 | BNC connector — SDI 4 with an LED that turns on green when a valid sync has been detected |

Features

- Provides up to six (6) independent signals
- One channel of DisplayPort video on a full-size DisplayPort connector.
- One channel of HDMI video on a Type A connector.
- Process up to four independent SDI signals with support for SD, HD, 3G, 6G and 12G in Single Link, Dual Link (1.5G) or Quad Link (3G)
- Each input channel includes an LED that turns green when a valid sync is detected.

Specifications

DisplayPort

- DisplayPort per 1.2 specification
- Pixel clock up to 620 MHz
 - Max pixel clock at 24 bits/pixel = 620 Mpix/sec
 - Max pixel clock at 30 bits/pixel = 576 Mpix/sec
 - Max pixel clock at 36 bits/pixel = 480 Mpix/sec

4. Hardware orientation

- Supported formats
 - formats up to 4096x2160@60 (30 bits)
 - 4K/UHD Supported:
 - 3840x2,400/ 50/59.94/60 via 1x DP
 - 4096x2,160/ 50/59.94/60 via 1x DP
 - 3840x2,160/ 50/59.94/60 via 1x DP
- Supply up to 500 mA @ 3.3V on pin 20
 - Allows the DP connector to power an external device
 - Overcurrent protection provided by means of a re-settable fuse
- Multi-Stream Transport (MST)—not supported
- EDID version 1.3 compatible
- HDCP version 1.3 compatible

HDMI

- HDMI per 2.0 specification
- Pixel clock up to 600 MHz
 - Max pixel clock at 24 bits/pixel = 600 Mpix/sec
 - Max pixel clock at 30 bits/pixel = 480 Mpix/sec
 - Max pixel clock at 36 bits/pixel = 400 Mpix/sec
- Supported formats
 - formats up to 2560x1600@60 and 3840x1200@60 (30 bits)
 - 4K/UHD Supported:
 - 3840x2400/ 50/59.94/60 input via 1x HDMI
 - 4096x2160/ 50/59.94/60 input via 1x HDMI
 - 3840x2160/ 50/59.94/60 input via 1x HDMI
- EDID version 1.3 compatible
- HDCP version 1.4 and version 2.2 compatible

SDI

- Supported formats:

Signal type	Min. BNC connector number	Max channels per card	Standard	Examples
SD	1	4	SMPTE 259M-C	480i, 576i (NTSC/PAL)
HD	1	4	SMPTE 292M	1920x1080 @ 59.94i/50i 1920x1080psf @ 23.98/24/25/29.97/30 720x480 @ 60p/50p
3G	1	4	SMPTE 424M Barcolink	1920x1080 @ 60p/50p 1920x1200 @ 60p/50p
6G	1	1	SMPTE 2081-10	3840x2160 @ 23.98/24/25/29.97/30 4096x2160 @ 23.98/24/25/29.97/30
12G	1	1	SMPTE 2082-10	3840x2160 @ 50/59.94/60 4096x2160 @ 50/59.94/60
4K / UHD	4	1	SMPTE 292M SMPTE 2048-2	Image mapping: Quadrants 3840x2160 @ 23.98/24/25/29.97/30 as 4x HD-SDI 4096x2160 @ 23.98/24/25/29.97/30 as 4x HD-SDI
4K / UHD	4	1	SMPTE 424M SMPTE 2048-2	Image mapping: Quadrants 3840x2160 @ 50/59.94/60 as 4x 3G-SDI 4096x2160 @ 50/59.94/60 60 as 4x 3G-SDI Level A and B supported
4K / UHD	4	1	SMPTE ST 425-5	Image mapping: 2 Sample Interleave Subdivision (2SI) 3840x2160 @ 23.98/24/25/29.97/30 as 4x HD-SDI 4096x2160 @ 23.98/24/25/29.97/30 as 4x HD-SDI 3840x2160 @ 50/59.94/60 as 4x 3G-SDI 4096x2160 @ 50/59.94/60 60 as 4x 3G-SDI Level A and B supported

**DisplayPort**

Digital display interface developed by the Video Electronics Standards Association (VESA). This royalty-free interface is primarily used to connect a video source to a display device such as a computer monitor, though it can also be used to transmit audio, USB, and other forms of data. VESA designed it to replace VGA, DVI, and FPD-Link. Backward compatibility to VGA and DVI by using active adapter dongles enables users to use DisplayPort fitted video sources without replacing existing display devices.

**HDMI**

HDMI (High-Definition Multimedia Interface) is a compact audio/video interface for transferring uncompressed video data and compressed/uncompressed digital audio data from a HDMI-compliant device ("the source device") to a compatible computer monitor, video projector, digital television, or digital audio device. HDMI is a digital replacement for existing analog video standards.

**SDI**

Serial Digital Interface (SDI) is a serial link standardized by the Society of Motion Picture and Television Engineers (SMPTE). SDI transmits uncompressed digital video over 75-ohm coaxial cable within studios, and is seen on most professional video infrastructure equipment.

4.7 Quad Channel DisplayPort Output Card

General

The quad channel DisplayPort output card has four 20-pin DisplayPort connectors that can provide a DisplayPort signal.

The figure below illustrates the DisplayPort output card's rear panel connectors:

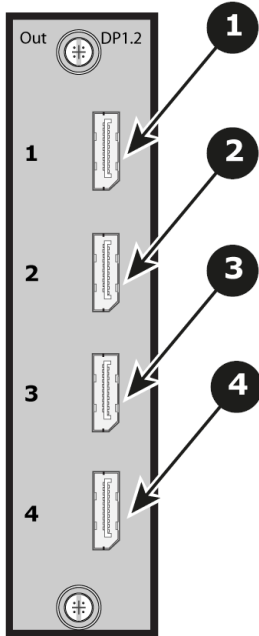

Image 4-12
Quad Channel DisplayPort Output Card Rear Panel

1	DP connector — DP 1
2	DP connector — DP 2
3	DP connector — DP 3
4	DP connector — DP 4

Features

- Four channels of DisplayPort video output, each on a full-size DisplayPort external connector
- Provides up to four (4) independent signals

Specifications

- DisplayPort per 1.2 specification
- Pixel clock up to 620 MHz
 - Max pixel clock at 24 bits/pixel = 620 Mpix/sec
 - Max pixel clock at 30 bits/pixel = 576 Mpix/sec
 - Max pixel clock at 36 bits/pixel = 480 Mpix/sec
- Supported formats:
 - formats up to 4,096x2,160@60 (30 bits)
 - 4K/UHD Supported:
 - o 3,840x2,160/ 23.98/24/25/29.97/30 via 1x DP, 2x DP (L and R half) or 4x DP (quadrants)
 - o 3,840x2,160/ 50/59.94/60 via 1x DP, 2x DP (L and R half) or 4x DP (quadrants, or columns)
 - o 4,096x2,160/ 23.98/24/25/29.97/30 via 1x DP, 2x DP (L and R half) or 4x DP (quadrants)
 - o 4,096x2,160/ 50/59.94/60 via 1x DP, 2x DP (L and R half) or 4x DP (quadrants or columns)
- Supply up to 500 mA @ 3.3V on pin 20
 - Allows the DP connector to power an external device
- Multi-Stream Transport (MST)—**not** supported
- EDID version 1.4 compatible
- HDCP version 1.3 supported on connectors 1 and 2



DisplayPort

Digital display interface developed by the Video Electronics Standards Association (VESA). This royalty-free interface is primarily used to connect a video source to a display device such as a computer monitor, though it can also be used to transmit audio, USB, and other forms of data. VESA designed it to replace VGA, DVI, and FPD-Link. Backward compatibility to VGA and DVI by using active adapter dongles enables users to use DisplayPort fitted video sources without replacing existing display devices.

4.8 HDMI Output Card

General

The HDMI output card has four 19-pin HDMI connectors which can provide a HDMI video signal.

The figure below illustrates the HDMI output card's rear panel connectors:

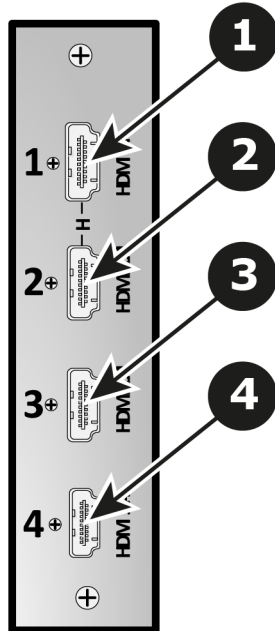

Image 4-13
HDMI Output Card Rear Panel

1	HDMI connector — HDMI 1
2	HDMI connector — HDMI 2
3	HDMI connector — HDMI 3
4	HDMI connector — HDMI 4

Features

- Default slot(s): 11, 12, 14
- Provide up to 4 independent signals
- 4x 19-pin HDMI connector (Type A)
- The two connectors support single link signals up-to 300 MHz.

Specifications

- HDMI per 1.4a Specification
- Supported format:
 - formats up to 2,560x1,600@60 and 3,840x1,200@60 (30 bits)
 - 4K/UHD Supported:
 - o 3,840x2,160/ 23.98/24/25/29.97/30 input via 1x HDMI, 2x HDMI (L and R half) or 4x HDMI (quadrants)
 - o 3,840x2,160/ 50/59.94/60 input via 2x HDMI (L and R half) or 4x HDMI (quadrants)
 - o 4,096x2,160/ 23.98/24/25/29.97/30 input via 1x HDMI, 2x HDMI (L and R half) or 4x HDMI (quadrants)
 - o 4,096x2,160/ 50/59.94/60 input via 2x HDMI (L and R half) or 4x HDMI (quadrants)
 - EDID version 1.3 compatible
 - HDCP version 1.4 compatible

4.9 SDI Output Card

General

Process up to four independent SDI signals with support for SD, HD, 3G, 6G and 12G in Single Link, Dual Link (1.5G) or Quad Link (3G).

The figure below illustrates the SDI Output Card's rear panel connectors:

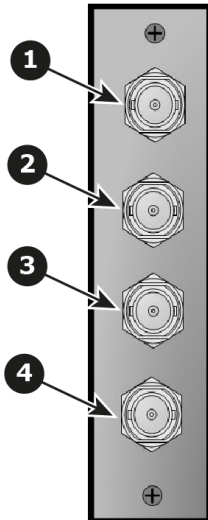

Image 4-14
SDI output Card Rear Panel

1	BNC connector — SDI 1
2	BNC connector — SDI 2
3	BNC connector — SDI 3
4	BNC connector — SDI 4

Features

- Provides up to 4 independent signals
- Automatic SD, HD, and 3G SDI Switching
- Single Link SD/ HD/ 3G SDI Output
- Quad Link UHD input as 4x HD/ 3G-SDI Output

Specifications

- Supported format:

Signal type	Min. BNC connector number	Max channels per card	Standard	Examples
SD	1	4	SMPTE 259M-C	480i, 576i (NTSC/PAL)
HD	1	4	SMPTE 292M	1920x1080 @ 59.94i/50i 1920x1080psf @ 23.98/24/25/29.97/30 720x480 @ 60p/50p
3G	1	4	SMPTE 424M Barcolink	1920x1080 @ 60p/50p 1920x1200 @ 60p/50p
4K / UHD	4	1	SMPTE 292M SMPTE 2048-2	Image mapping: Quadrants 3840x2160 @ 23.98/24/25/29.97/30 as 4x HD-SDI 4096x2160 @ 23.98/24/25/29.97/30 as 4x HD-SDI
4K / UHD	4	1	SMPTE 424M SMPTE 2048-2	Image mapping: Quadrants 3840x2160 @ 50/59.94/60 as 4x 3G-SDI 4096x2160 @ 50/59.94/60 60 as 4x 3G-SDI Level A and B supported
4K / UHD	4	1	SMPTE ST 425-5	Image mapping: 2 Sample Interleave Subdivision (2SI) 3840x2160 @ 23.98/24/25/29.97/30 as 4x HD-SDI 4096x2160 @ 23.98/24/25/29.97/30 as 4x HD-SDI 3840x2160 @ 50/59.94/60 as 4x 3G-SDI 4096x2160 @ 50/59.94/60 60 as 4x 3G-SDI Level A and B supported



SDI

Serial Digital Interface (SDI) is a serial link standardized by the Society of Motion Picture and Television Engineers (SMPTE). SDI transmits uncompressed digital video over 75-ohm coaxial cable within studios, and is seen on most professional video infrastructure equipment.

4.10 Tri-Combo Output Card

General

This card provides one 20-pin DisplayPort connector, supporting DisplayPort video signal; one 19-pin HDMI connector, supporting an HDMI video signal; and 4 BNC connectors, supporting Single Link, Dual Link, and Quad Link signals, in SD, HD, 3G, 6G, and 12G SDI formats.

The figure below illustrates the tri-combo output card's rear panel connectors:

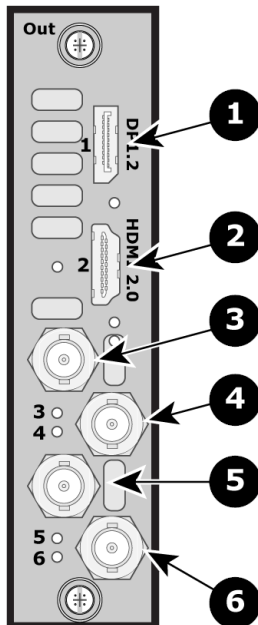

Image 4-15
Tri-Combo Output Card Rear Panel

1	DP connector
2	HDMI connector
3	BNC connector — SDI 1
4	BNC connector — SDI 2
5	BNC connector — SDI 3
6	BNC connector — SDI 4

Features

- Provides up to six (6) independent signals
- One channel of DisplayPort video on a full-size DisplayPort connector.
- One channel of HDMI video on a Type A connector.
- Process up to four independent SDI signals with support for SD, HD, 3G, 6G, and 12G in Single Link, Dual Link (1.5G) or Quad Link (3G)

Specifications

DisplayPort

- DisplayPort per 1.2 specification
- Pixel clock up to 620 MHz
 - Max pixel clock at 24 bits/pixel = 620 Mpix/sec
 - Max pixel clock at 30 bits/pixel = 576 Mpix/sec
 - Max pixel clock at 36 bits/pixel = 480 Mpix/sec

4. Hardware orientation

- Supported formats
 - formats up to 4096x2160@60 (30 bits)
 - 4K/UHD Supported:
 - 3840x2,400/ 50/59.94/60 via 1x DP
 - 4096x2,160/ 50/59.94/60 via 1x DP
 - 3840x2,160/ 50/59.94/60 via 1x DP
- Supply up to 500 mA @ 3.3V on pin 20
 - Allows the DP connector to power an external device
 - Overcurrent protection provided by means of a re-settable fuse
- Multi-Stream Transport (MST)—not supported
- EDID version 1.3 compatible
- HDCP version 1.3 compatible

HDMI

- HDMI per 2.0 specification
- Pixel clock up to 600 MHz
 - Max pixel clock at 24 bits/pixel = 600 Mpix/sec
 - Max pixel clock at 30 bits/pixel = 480 Mpix/sec
 - Max pixel clock at 36 bits/pixel = 400 Mpix/sec
- Supported formats
 - formats up to 2560x1600@60 and 3840x1200@60 (30 bits)
 - 4K/UHD Supported:
 - 3840x2400/ 50/59.94/60 input via 1x HDMI
 - 4096x2160/ 50/59.94/60 input via 1x HDMI
 - 3840x2160/ 50/59.94/60 input via 1x HDMI
- EDID version 1.3 compatible
- HDCP version 1.4 and version 2.2 compatible

SDI

- Supported formats:

Signal type	Min. BNC connector number	Max channels per card	Standard	Examples
SD	1	4	SMPTE 259M-C	480i, 576i (NTSC/PAL)
HD	1	4	SMPTE 292M	1920x1080 @ 59.94i/50i 1920x1080psf @ 23.98/24/25/29.97/30 720x480 @ 60p/50p
3G	1	4	SMPTE 424M Barcolink	1920x1080 @ 60p/50p 1920x1200 @ 60p/50p
6G	1	1	SMPTE 2081-10	3840x2160 @ 23.98/24/25/29.97/30 4096x2160 @ 23.98/24/25/29.97/30
12G	1	1	SMPTE 2082-10	3840x2160 @ 50/59.94/60 4096x2160 @ 50/59.94/60
4K / UHD	4	1	SMPTE 292M SMPTE 2048-2	Image mapping: Quadrants 3840x2160 @ 23.98/24/25/29.97/30 as 4x HD-SDI 4096x2160 @ 23.98/24/25/29.97/30 as 4x HD-SDI
4K / UHD	4	1	SMPTE 424M SMPTE 2048-2	Image mapping: Quadrants 3840x2160 @ 50/59.94/60 as 4x 3G-SDI 4096x2160 @ 50/59.94/60 60 as 4x 3G-SDI Level A and B supported
4K / UHD	4	1	SMPTE ST 425-5	Image mapping: 2 Sample Interleave Subdivision (2SI) 3840x2160 @ 23.98/24/25/29.97/30 as 4x HD-SDI 4096x2160 @ 23.98/24/25/29.97/30 as 4x HD-SDI 3840x2160 @ 50/59.94/60 as 4x 3G-SDI 4096x2160 @ 50/59.94/60 60 as 4x 3G-SDI Level A and B supported

**DisplayPort**

Digital display interface developed by the Video Electronics Standards Association (VESA). This royalty-free interface is primarily used to connect a video source to a display device such as a computer monitor, though it can also be used to transmit audio, USB, and other forms of data. VESA designed it to replace VGA, DVI, and FPD-Link. Backward compatibility to VGA and DVI by using active adapter dongles enables users to use DisplayPort fitted video sources without replacing existing display devices.

**HDMI**

HDMI (High-Definition Multimedia Interface) is a compact audio/video interface for transferring uncompressed video data and compressed/uncompressed digital audio data from a HDMI-compliant device ("the source device") to a compatible computer monitor, video projector, digital television, or digital audio device. HDMI is a digital replacement for existing analog video standards.

**SDI**

Serial Digital Interface (SDI) is a serial link standardized by the Society of Motion Picture and Television Engineers (SMPTE). SDI transmits uncompressed digital video over 75-ohm coaxial cable within studios, and is seen on most professional video infrastructure equipment.

4.11 Expansion Link card

About Expansion link

When event requirements exceed the capacity of a single unit in terms of input, output, or number of layers, multiple Event Master processors can be linked together through the Expansion Link cards.



CXP

CXP is a copper connector system specified by the InfiniBand Trade Association. It provides twelve 10 Gbit/s links suitable for single 100 Gigabit Ethernet, three 40 Gigabit Ethernet channels, or twelve 10 Gigabit Ethernet channels or a single Infiniband 12× QDR link. The connector has 4 rows, each of 21 pin, total 84 pins.

[Note 1]: The C is the Roman numeral for 100.

General

The Link card has 2 CXP connectors which can support up to 12 10-Gbit channels.

The figure below illustrates the Link card's rear panel connectors:

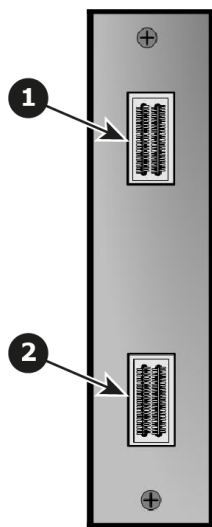

Image 4-16

1	CXP connector — CXP 1
2	CXP connector — CXP 2

Features

- Provide up to 12 10-Gbit channels
- Depending on the Event Master processor model, two, one, or no slots are reserved at left side of the rear panel for Expansion Link cards.

E2	E2 Jr.	S3-4K	S3-4K Jr.	EX
1, 2	NA ¹	1	NA ¹	NA ²



¹ E2 Jr. and S3-4K Jr. do not have Link cards, but these models can be upgraded with Link cards, which would go into the same slots as the Link cards on the E2 and the S3-4K.

² The EX has two (2) Expansion Links, but they are not on a swappable card.

Specifications

- CXP Specification

4.12 VPU card

General

VPU (Video Processing Unit) cards perform the various scaling, layer effects, and image compositing operations within the Event Master series of products. The internal cross point routes all video signals to and from the VPU cards. The VPU cards have no external connections.

Features

- Support for 2K, Dual Link, and 4K video processing
- Layer compositing over unscaled Backgrounds
- Layer effects, including Borders and Shadows
- Keying effects
- Keyframe effects

Specifications

Each VPU card is a 4K scalar capable of acting as a 4K scalar, or as two (2) Dual Link scalars, or as four (4) 2K HD scalars

Mixing Layer Type	Maximum number of Single Layers/Mixing Layers				
	E2	E2 Jr.	S3-4K	S3-4K Jr.	EX
2K HD	32/16	16/8	8/4	4/2	Up to 16/8
Dual Link	16/8	8/4	4/2	2/1	Up to 8/4
4K	8/4	4/2	2/1	NA	Up to 4/2

The VPU cards are not accessible from the rear panel on E2 and E2 Jr. units. Even though they have no external connections, slots 2 and 3 are reserved for VPU cards on S3-4K and S3-4K Jr. units. The EX expansion box can have a combination of Input and Output cards, or it can have two VPU cards.

5. FRONT PANEL MENU ORIENTATION

About this chapter

This chapter describes the front panel menus of the Event Master units (E2 and S3 series), including how they are accessed and the functions or parameters that are available. The menu trees are presented in block diagram format throughout the chapter.

Overview

- Power-up initialization
- Front Panel menu tree
- Using menu system
- About Status menu
- About Setup menu
- About the System menu
- System menu > Black Invalid
- System menu > USB device (Backup/Restore)
- System menu > Ethernet
- System menu > VFD brightness (display brightness)
- System menu > Diagnostics
- System menu > Lock front panel
- Using the Tech Support menu
- Restoring Factory Default Settings
- Firmware Upgrade
- Save All

5.1 Power-up initialization

Initialization

Ensure that your system is properly installed and cabled. Make sure the two AC Connector are properly connected to your facility's AC power source through the two supplied power cords. Locate the power button on the front panel and turn power On. While the system is initializing, the front-panel buttons light up one at a time, and the following message is displayed.



Image 5-1
System Initialization Message

After system initialization is complete, the **Status** menu appears.



If under some rare circumstance the system does not fully boot correctly, press and hold the SEL and ESC keys while applying power to the unit. Release these keys when a menu appears asking to Factory Reset the unit. Perform the Factory Reset and the unit will boot normally.

5.2 Front Panel menu tree

About this section

The diagram below illustrates the Front Panel menu tree of the Event master devices. Please use this diagram for reference as you learn how to operate the system.

Menu tree

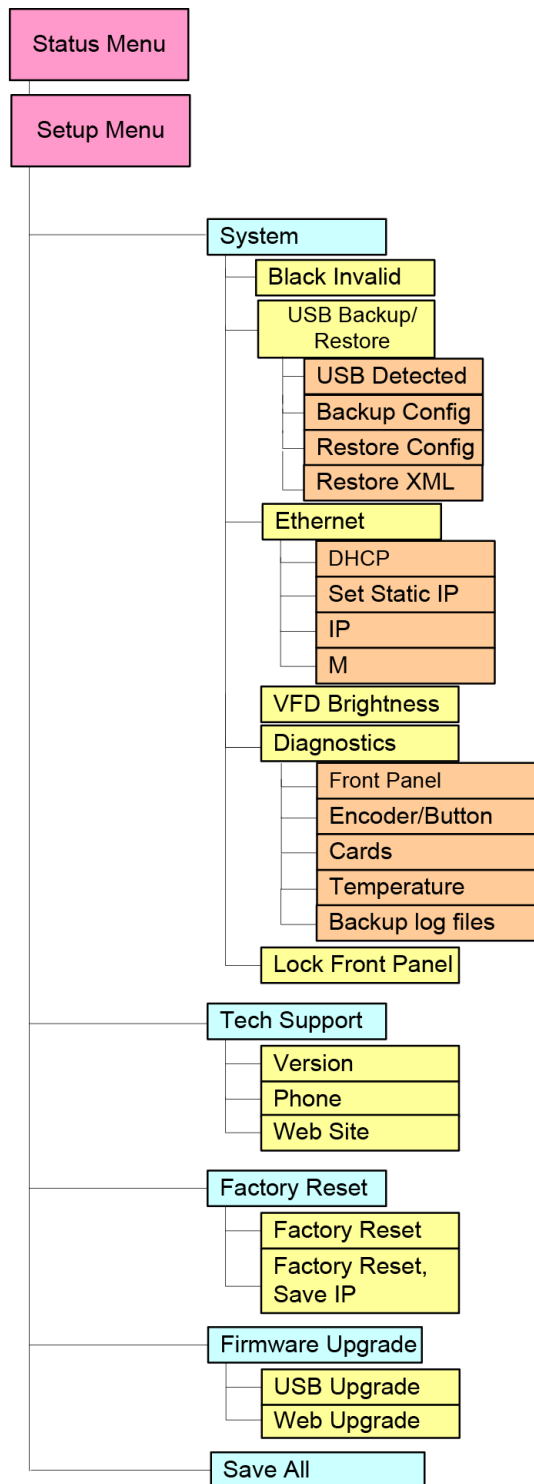

Image 5-2

5.3 Using menu system

General

This section describes the conventions for using the menu system of the Event Master devices. For reference, the following illustration shows the **System** Menu.



Image 5-3
System menu



The unit's display screen is four lines high. Throughout this chapter, entire menus are shown for ease of reference, unless otherwise noted.

Please note the following important menu rules and conventions:

- The top line names the current menu, in upper-case letters.
- Subsequent lines typically display two fields:
 - For a **function**, the left-hand field names the function. The right-hand field shows the function's current parameter (or value). In the preceding illustration, **Black Invalid** is a function and **On** is its current value.
 - For a **submenu**, the left-hand field names the submenu that you can access. The right-hand field displays a double arrow (>>), indicating that a submenu is available. In the preceding illustration, **USB Backup/Restore** and **Ethernet** are two of the available submenus. To use a submenu, scroll to it and press **SEL**. Then scroll through the list that appears.
 - The **navigation cursor** (>) in the left-hand column indicates the current line on which you can take action. This arrow moves as you rotate the **ADJUST** knob on the front panel. When you reach an editable field and press **SEL**, the navigation cursor changes to an **edit cursor** (#).

Making a menu selection

To select a menu item, use the **ADJUST** knob to scroll to the item, then press the **SEL** button on the front panel:

- To scroll through a menu:
 - Turn the **ADJUST** knob counter-clockwise to scroll down.
 - Turn the **ADJUST** knob clockwise to scroll up.
- To open a submenu, scroll to the submenu line and press **SEL**.
- To change a parameter, scroll to the desired line and press **SEL**. The navigation cursor changes to the edit cursor. Use the **ADJUST** knob to modify the value:
 - Turn the **ADJUST** knob clockwise to increase a value.
 - Turn the **ADJUST** knob counter-clockwise to decrease a value.
- Then press **SEL** to accept a parameter or value. The edit cursor changes back to the navigation cursor.



You must press **SEL** to accept the value.



Throughout this user's guide, the term "select" is used as an abbreviation for "scroll to a menu line and press **SEL**."

Example: Select the Ethernet menu to begin configuring network settings.

Exiting a menu

- In the edit mode (i.e., the edit cursor is visible), press **ESC** to exit a menu without changing the original parameter.
- To navigate back up the menu structure, press **ESC** again. Each press takes you back up the menu tree by one level.

Answering a menu query

The **SEL** button is used to answer **Yes** to certain menu queries. The **ESC** button is used to answer **No** to menu queries. Sometimes the two buttons are appropriate for answer to a menu queries. The following illustration shows an example of a menu query.

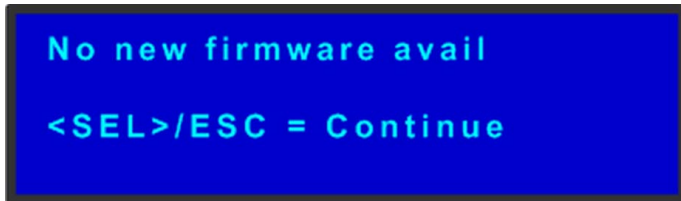

Image 5-4
Validation error message

Edit name

Sometimes, it is necessary to edit name, like the name of a configuration file, for example. To modify name use the following procedure:

1. Navigate to submenu (For example, the following illustration shows the **USB Backup Config** submenu).

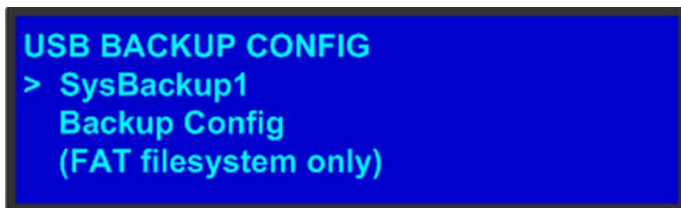

Image 5-5
USB Backup Config submenu

The navigator cursor (>) is at the field targeted.

2. Press **SEL**.
The navigation cursor changes to the edit cursor. A blank field for the first character becomes available and this field is marked by an underscore.
3. Use the **ADJUST** knob to scroll to the first character you want to use for the format name.

Turning the **ADJUST** knob clockwise once moves to the next letter of the alphabet. If you start with an upper-case letter, as shown in the preceding illustration, then the next letter is also a capital letter. If you start with a lower-case letter, the next letter is a lower-case letter:

- F → G
- f → g

If you start with a number, the next character is a number.

Continuing to turn the **ADJUST** knob clockwise at the end of the upper-case alphabet displays a series of punctuation marks you can use in the format name.

Continuing to turn the knob clockwise at the end of the punctuation marks displays the lower-case alphabet in order.

When you reach the end of the lower-case alphabet, turn the **ADJUST** knob counter-clockwise to scroll back through the options in order.

4. Press **SEL**. The cursor moves to the next character field, which is now blank with an underscore.
5. Repeat the previous steps as many times as needed, pressing **SEL** for each character selection.
6. When you have selected all the characters, press **SEL** again to save the name.



A file name can consist of up to 19 alpha-numeric characters.

5.4 About Status menu

General

The **Status** Menu is the Event Master series processor's top-level menu, which appears by default at system startup. This menu provides system name, Unit ID, Genlock status and unit IP address. The following figure illustrates a sample **Status** Menu. Press the **ESC** button when the **Setup** menu is displayed allows to return in the **Status** menu.

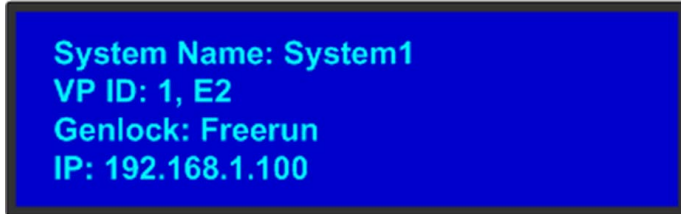

Image 5-6
e.g. E2 Status menu

System name

Human readable name of the current system. Particularly useful in the user interface when multiple Event Master system are connected in the same network.

System1 is the default value. This name can be changed in the configuration page of the GUI. For more details please refer to the section dedicated to the system configuration in the chapter "Configuration Menu", page 106.

Unit ID

ID required to identify different units are acting as a single system in order to expand for Inputs, Outputs or Layers.

This ID can be changed in the configuration page of the GUI. For more details please refer to the section dedicated to the System configuration in the chapter "Configuration Menu", page 106.

Genlock

This line gives information about the Genlock connection situated at the back of the Event Master unit. For more detail on this connection please refer to the section dedicated to the Genlock Input BNC in the chapter "Rear panel", page 46.

The user could turn Genlock OFF or ON in the configuration page of the GUI. The Event Master unit will determine what kind of Genlock is connected and will update the Status field. The status field can say "Locked", "Lost Lock" or "Free Run". For more details please refer to the section dedicated to the Event Master unit configuration in the chapter "System Setup", page 243.

IP address

IP address of the Event Master unit in the local network.

If there is no internet connection, or if a DHCP server has not been found, the IP address is 000.000.000.000. The IP address is needed for running the Web Interface and for connection to an external device. For more details please refer to the section dedicated to the setting of Ethernet options in the chapter "About the System menu", page 78

5.5 About Setup menu

General

The **Setup** menu, shown in the following illustration, is the menu from which you access all operational menus. To display the **Setup** menu, press the **SEL** button on the front panel when the Status menu is displayed, or press the **ESC** button to go back from a submenu (one level for each time you press the button).



Image 5-7
Setup menu

From the **Setup** menu, you can configure certain system settings for the Event Master unit, display Technical Support contact information, restore factory default settings, and check for available firmware updates. And finally, you can save all the recent changes to the system.

The following sections describe each Setup Menu option in detail, except for the Code Upgrade feature. For details about that option, refer to the chapter "Updating firmware", page 279:

- "About the System menu", page 78
- "Using the Tech Support menu", page 92
- "Restoring Factory Default Settings", page 93
- "Updating firmware", page 279
- "Save All", page 95

5.6 About the System menu

General

The **System** Menu, shown in the following illustration, allows you to view and change settings such as HDCP status and Ethernet options. In this menu you can also backup or restore Event Master unit configuration, obtain diagnostic information, adjust the intensity or lock the display screen.



Image 5-8
System menu

The following sections describe each Setup Menu option in detail:

- "System menu > Black Invalid", page 79
- "System menu > USB device (Backup/Restore)", page 80
- "System menu > Ethernet", page 84
- "System menu > VFD brightness (display brightness)", page 86
- "System menu > Diagnostics", page 87
- "System menu > Lock front panel", page 91

5.7 System menu > Black Invalid

General

The **Black Invalid** system setting determines whether the output is black when connected to a signal it cannot process. **Black Invalid** is either **On** or **Off**. The default setting is **On**. This is a global setting, applicable to all outputs.

5.8 System menu > USB device (Backup/Restore)

General

The unit's front panel contains a USB port that you can use to connect a flash drive to the Event Master unit.



The flash drive must be formatted to use the FAT32 file system. For formatting instructions, refer to section **Formatting the flash drive** in the chapter "Upgrading firmware using the USB port", page 280.

The following illustration shows the **USB Backup/Restore** submenu, which you access from the **System** menu.



Image 5-9
USB submenu

Using this menu, you can:

- Detect the presence of a USB device.
- Backup and restore the Event Master unit configuration files. When you connect a flash drive to the unit, the system creates a directory titled **E2Backup** on the drive. All configuration files are saved to this directory.
- Import an configuration created offline, via an XML file on the USB device.

How to back up a configuration file to a flash drive

1. Insert a formatted flash drive in the unit's front-panel USB port.
2. From the **System** menu, scroll to the **USB Backup/Restore** submenu. Select **Backup Config**.

The **USB Backup Config** submenu appears, as shown in the following illustration. The navigation cursor appears at the default name for the first backup file.

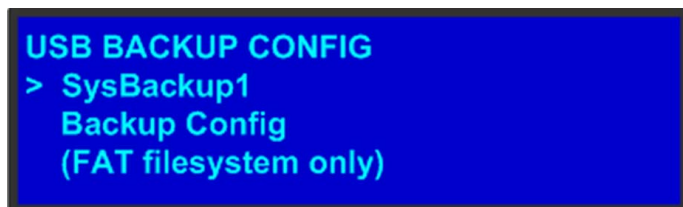

Image 5-10
USB Backup Config submenu

3. If you wish to change the default name of the backup configuration, press **SEL**. Use the **ADJUST** knob to change the name, as described in section "Using menu system", page 74. Press **SEL** again when you complete the name change.
4. Scroll to **Backup Config** and press **SEL**.

A confirmation message appears when the backup is complete.

If the backup operation fails, the message shown in the following illustration appears. Check that the flash drive is properly formatted and installed, and try again.



Image 5-11

How to restore a system configuration file that is stored on a flash drive

1. Insert a formatted flash drive in the unit's front-panel USB port.
2. From the **System** menu, scroll to the **USB Backup/Restore** submenu. Select **Restore Config**.

The **USB Restore Config** submenu appears, as shown in the following illustration.



Image 5-12

3. Press **SEL** and scroll through the list of configuration files. When you locate the file you want, press **SEL** again.
4. Scroll to **Restore Config** and press **SEL**.

A message confirms the restore operation and instructs you to reboot the Event Master unit.



You must reboot the Event Master unit to use the restored configuration file.

How to create a configuration offline and transfer it to a live unit

When working in the Event Master Toolset Software with a simulator, it is now possible to create a configuration offline and then transfer it to a live unit.

1. System creation:
 - a) Create your system offline using the simulator. This includes system configuration, presets, MVR, etc ...
 - b) Save the simulated configuration.
Press the **Save** icon (the floppy disk icon in the lower left-hand corner of the screen).
2. Copy the XML file to the USB device:

5. Front Panel Menu orientation

- a) Open **Windows File Explorer**.
- b) Locate and select the **Barco** folder on your **C: drive**.

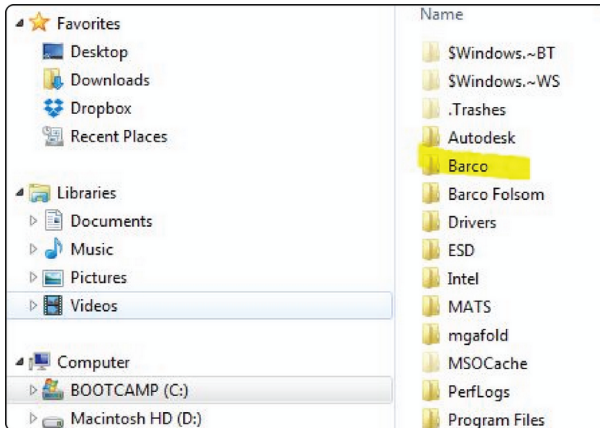

Image 5-13

- c) Locate in the Barco folder and select the Event Master Toolset folder that corresponds to the current version you are using.

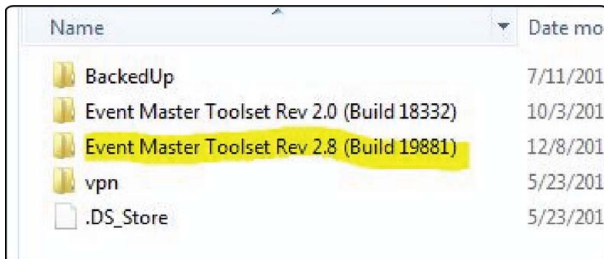

Image 5-14

- d) Select the **wvp_9876** subfolder.

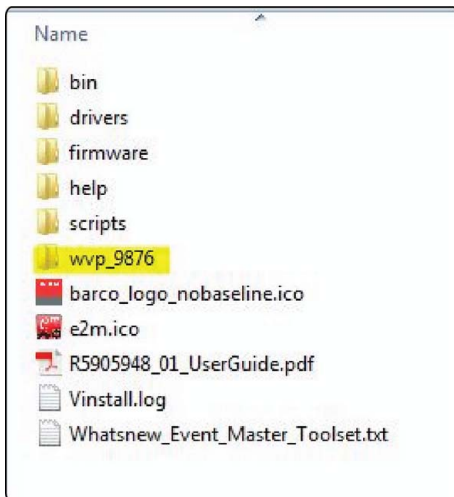

Image 5-15

- e) Open the **xml** folder.

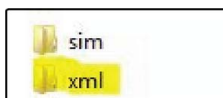

Image 5-16

The xml folder contains subfolders for presets, stills, and userkeys, and it contains the configuration settings file for your simulated system.

- f) Create a folder on your desktop called **EM**, and create a subfolder inside it called **Backup**.
- g) Copy and paste the **xml** folder from the wvp_9876 folder into the EM\Backup folder.
- h) Open the **xml** folder in the EM\Backup folder.
- i) Rename the **settings.xml** file to **settings_backup.xml**.
Make sure that you do not change the file extension.
- j) Copy and paste the entire **EM** folder from your desktop to the root directory of a FAT32-formatted USB drive.

3. Import the simulated configuration created offline to the live system:
 - a) Insert the USB drive into the USB port on the front of a live Event Master processor.
The live processor must be the same type as the simulated processor. If your simulated processor was an E2, the live processor must be an E2; if your simulated processor was an S3-4K, your live processor must be an S3-4K. The card setup on the simulated system must match the card setup on the live system, otherwise Inputs might not match, or Destinations might be created on nonexistent Outputs. Those Destinations will be grayed out, and you'll have to recreate them.
 - b) Navigate on the front-panel display screen to the **System** menu, then to **USB Backup/Restore**, and then to **Restore XML**, and then hit **Select**.
The system uploads the backup xml folder. When finished, the display screen reads "Restore successful."
 - c) Select **Yes (<SEL>)**, when the system asks "Reset unit now?"
The unit begins to reset. This takes about two minutes.
 - d) Remove the USB drive.

Once the system resets, all the Inputs, Outputs, Destinations Presets, etc. from the simulated unit will have been transferred to the live unit.

The icons from the simulated unit do not transfer to the live unit and must be recreated.

If the Multiviewer configurations are not transferred, they must be recreated.

5.9 System menu > Ethernet

General

The **Ethernet** submenu allows the user to view and change certain Ethernet settings.



Image 5-17

Using this menu, you can:

- Query the DHCP server for a valid IP address, or turn off this feature.
- Set a static IP address for the Event Master unit, along with a subnet mask and gateway. This feature is available only if **DHCP** is turned **Off**.
- View the unit's IP address.
If there is no internet connection, or if a DHCP server has not been found, the IP address is 000.000.000.000. In this case, the system ignores the Ethernet port.
- View the Media Access Control (MAC) address of the unit's Ethernet port.

Query the DHCP server

In the **Ethernet** submenu, the default setting for **DHCP** is **On**. When **DHCP** is turned on, the system automatically queries the DHCP server for a valid IP address. If the unit receives an IP address, that address is displayed in the **Ethernet** submenu.



It can take several seconds to obtain an address from the server. During this time, the SEL button remains lit.

When **DHCP** is off, you can manually enter a static IP address, along with a subnet mask and gateway, in the **Set Static IP** submenu. Consult your network administrator for a valid IP address, subnet mask and gateway.

Setting a static IP Address

When a DHCP server is not available, you can set the Event Master unit's IP address, using the **Set IP** submenu shown in the following illustration.

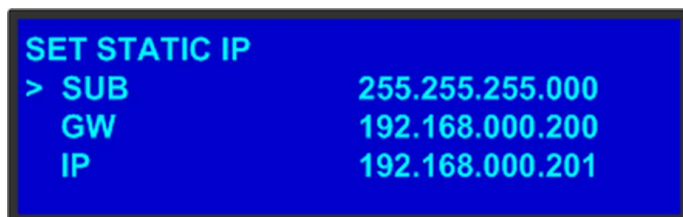

Image 5-18
Set IP Submenu (sample)

How to set a static IP address?

1. Ensure that the **DHCP** setting is **Off**.
2. From your network administrator, obtain a valid IP address, including subnet and gateway.
3. On the **Ethernet** submenu, select **Set Static IP**.
4. On the **Set IP** submenu, select **SUB**(net). The last character in the first field becomes available, as indicated by the empty field and an underscore.
Note: You must change the **SUB** parameter before editing either of the other parameters.
5. Turn the **ADJUST** knob to change the first value. As you continue turning the knob, you can change all three values in this field. Values range from **000** to **255** in all four fields.
6. Press **SEL** to accept your change in the first field. The last character in the next field becomes available.
7. Continue until you have created the subnet value you want. Press **SEL**.
8. Make similar changes in the **GW** and **IP** fields.
9. Press **SEL** to accept your final change.



If you press ESC at any time before accepting your final change, all your edits will be removed, and the original values restored.

5.10 System menu > VFD brightness (display brightness)

General

The **VFD Brightness** submenu adjust the intensity of the front panel vacuum fluorescent display (VFD) screen. The adjustment range is **+0** to **+6**, with **+6** being the brightest. The default setting is **+3**.

5.11 System menu > Diagnostics

General

The following illustration shows the **Diagnostics** submenu, which you access from the **System** menu.



Image 5-19

The Diagnostics options allow a user to check if the Event Master unit is functioning normally. Front panel and card operations can be checked. Various system temperatures can be monitored and backup log files can be saved for customer service troubleshooting.

Front Panel

When **Front Panel** is selected to be tested, the VFD display will initially be blanked. Then the 24 x 4 character grid will start to show from the dimmest setting to the brightest setting. At this point a user can determine if any of the pixels or if a character segment is bad in the display.

After several seconds of showing all pixels on at the brightest setting, the system will automatically advance to the **ENCODER/BUTTON TEST** menu (the next menu).



Directly select "Encoder/Button" from the Diagnostic menu will allow the user to test the keys and knob without the need to see the VFD being tested.

Encoder/Button

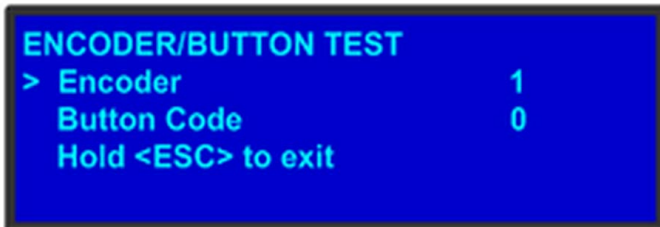

Image 5-20

The **ENCODER/BUTTON TEST** menu allow the user to test the keys and knob.

When the knob on the front panel is rotated, a number will be displayed on the encoder line. The larger the number, the faster the knob was rotated. The number will show as positive or negative depending on the direction the knob was turned.

Pressing any key on the front panel will show the Button Code for the key.

Button	Code
ESC	0
PWR	7
SEL	14

Hold **ESC** to exit and return to the DIAGNOSTIC menu.

Cards



Image 5-21

The Card Slot test will perform a variety of diagnostics for an individual card or for all cards. This is a quick way to determine if a given card is having a problem. After selecting a Slot number or choosing All cards to be tested, the following message will be displayed.



Image 5-22

Pressing **SEL** to continue will start the diagnostic testing. The following message will be displayed.

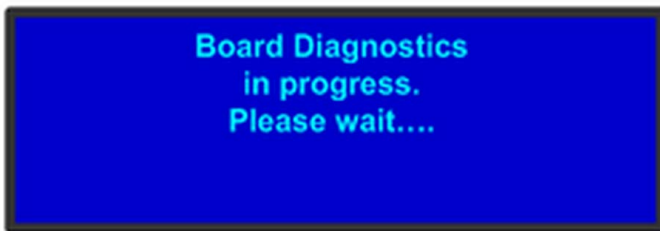

Image 5-23

If only one slot was selected for testing, a simply PASS/FAIL result will be shown for that slot.



Image 5-24

If all slots were selected for testing, the PASS/FAIL result will be shown for all slots.



Image 5-25



If a slot is not populated with a card, the result will show **EMPTY**.



To see more detailed results of diagnostic testing, run diagnostics from the Event Master Toolset Software. For details on this function, please refer to chapter "Settings Menu > Web App area > Dashboard", page 231

Temperature

DIAGNOSTIC TEMPERATURE	
> System Left	36.9
System Right	36.6
MB Left	32.2
MB Middle	34.2
MB Right	33.4
Slot 1 Temp	38.0
.	.
.	.
Slot 23 Temp	51.0

Image 5-26

The **DIAGNOSTIC TEMPERATURE** menu will show real time measurements for the System, Motherboard and all card slots. All temperatures are shown in degrees Celsius.



FPGA temperatures may reach as high as 85°C under normal operating conditions. Temperatures above 85°C may affect processing performance.

Backup Log Files

Backup log files can be saved for customer service troubleshooting.



In the event the log files of the Event Master unit need to be backed up, first install a USB stick in the unit's front panel.

When **Backup Log Files** is selected, the system will immediately write its log files to the USB stick. The following menus will be shown during this process and the Event Master unit will automatically return to the DIAGNOSTIC menu once this process is complete.

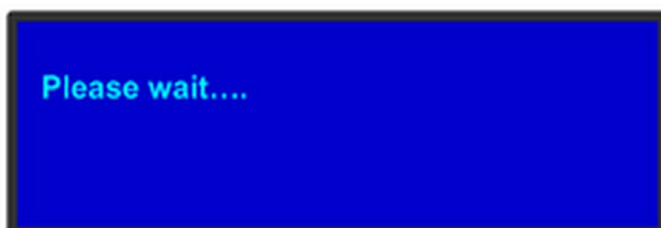

Image 5-27



Image 5-28

5. Front Panel Menu orientation



The file name will be “E2LogFiles.tar.gz”, and it can be found on the USB stick under the “E2\backup” directory.

5.12 System menu > Lock front panel

General

When the Event Master unit's front panel is locked, button presses have no effect. In the locked mode:

- All button presses (including **Power ON/OFF** button) and all turns of the **ADJUST** knob are ignored.
- All Ethernet communications commands function normally.

How to enable and disable the front-panel lock?

1. On the **System** menu, scroll to **Lock Front Panel** and press **SEL**. The front panel is locked, and the following message appears:



Image 5-29
Front Panel Locked Message

2. To disable the front panel lock, press and hold the **SEL** and **ESC** buttons simultaneously for 3 seconds. When the panel is unlocked, the display screen displays the **Status** menu.

5.13 Using the Tech Support menu

General

The **Tech Support** Menu, shown in the following illustration, provides quick access to Customer Support contact information, and also shows you the software version for your Event Master unit.



Image 5-30
Tech Support Menu

This menu displays:

- The software version of your Event Master unit . For more details on software upgrade instructions please refer to section "Updating firmware", page 279.
- The US Customer Support telephone number. This number is accessible from 6 a.m. to 10 p.m. (PST), 7 days per week. The European customer support number is: 0800-90-0410. In China call: 40088-22726. All other regions, call your local Barco support.
- The Customer Support web site address for all regions.

5.14 Restoring Factory Default Settings

General

As shown in the following illustration, two options in the **Setup** Menu allow you to restore the Event Master unit to its factory default condition.



Image 5-31

The following attributes constitute a factory default condition:

- The **Status** Menu is shown in the display screen.
- All custom configurations are deleted.

The **Factory Reset** Menu provides two options for restoring factory default settings:

- **Factory Reset** — If you use this option, all of your system configuration are deleted. Settings will be restored to the original factory defaults.
- **Factory Reset, Save IP** — This option performs a factory reset, but retains the IP address of the unit.



It is advisable to clear all saved configurations when you use the Event Master unit for the first time, or when returning an unit from an event.

Restoring all factory settings

To restore all default settings to the Event Master unit, use the following procedure:

1. Select **Factory Reset** from the **Setup** Menu.

The **Factory Reset** Menu appears.

2. Select **Factory Reset**.

A prompt appears, asking if you want to clear all configurations.

3. Press **SEL**.

The system turns off, then reboots.

If you press **ESC** to cancel the operation instead, your custom settings remain in place and you are returned to the **Factory Reset** Menu.

Retaining the IP address when restoring factory settings

To restore default settings to the Event Master unit but retain the unit's IP address, use the following procedure:

1. Select **Factory Reset** from the **Setup** Menu.

The **Factory Reset** Menu appears.

2. Select **Factory Reset, Save IP**.

A prompt appears, asking if you want to clear all configurations.

3. Press **SEL** to reset the system but save the IP address.

The system turns off, then reboots.

If you press **ESC** to cancel the operation instead, your custom settings remain in place and you are returned to the **Factory Reset** Menu.

5.15 Firmware Upgrade

General

The Event Master unit provides two options for upgrading firmware:

- Using the USB port on the front panel.
- Using the Web Interface.

Please refer to the chapter "Settings Menu", page 225 for the instructions on how to perform firmware upgrades through the USB memory or the web interface.

5.16 Save All

General

Save All on the **Setup** menu saves your custom configuration parameters in non-volatile memory.

If you save the system state, these parameters are restored the next time you power up the Event Master unit. If you do not use this function, your custom settings are not restored during the next system power up sequence.

Saving all modified settings

1. Select **Save All** from the **Setup** menu.

The following message appears:

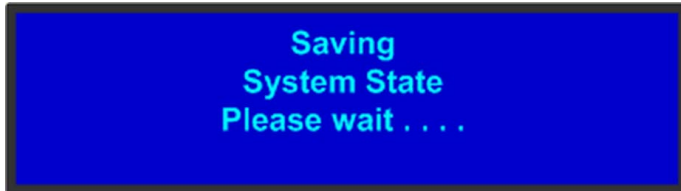

Image 5-32
"Saving all" message

2. Wait few seconds ...

Parameters are saved in non-volatile memory and you are returned to the **Setup** menu.

6. EM GUI ORIENTATION

About this chapter

This chapter provides a detailed description of each section of EM GUI.

About EM GUI

The Event Master (EM) GUI is a UI program that enables users to interface with an Event Master device from a PC or Mac via an Ethernet connection. The program provides a step-by-step approach to configure, program, setup the dedicated Multiviewer and manage system functions.



Some screenshots and descriptions provided in this chapter may not accurately reflect the released software. Barco will update the documentation in a timely manner to mirror the released software

Overview

- General requirements
- Download of Event Master Toolset Software
- Software installation
- Starting up
- Screen layout presentation
- Controls
- Configuration Menu
 - Configuration Menu > Network resource area
 - Configuration Menu > System diagram area
 - Configuration Menu > System modifier area
 - Configuration Menu > Adjustment area
 - Configuration Menu > Adjustment > Unit Configuration
 - Configuration Menu > Adjustment > Input Configuration
 - Configuration Menu > Adjustment > Background Configuration
 - Configuration Menu > Adjustment > Output Configuration
 - Configuration Menu > Adjustment > Destination Configuration
 - Configuration Menu > Linking
- Programming Menu
 - Programming Menu > Resources area
 - Programming Menu > Diagram area
 - Programming Menu > Layer Modifier area
 - Programming Menu > Adjustment area
 - Programming Menu > Adjustment area > Layer configuration
 - Programming Menu > Adjustment area > Dest Group configuration
 - Programming Menu > Adjustment area > Background configuration
 - Programming Menu > Adjustment area > User Keys configuration
 - Programming Menu > Adjustment area > Presets configuration
 - Programming Menu > Adjustment area > Source adjustment
 - Programming Menu > Adjustment area > Global Transition Rate/Trans/Cut
- Multiviewer (MVR) Menu
 - Multiviewer Menu > Resource area
 - Multiviewer Menu > Multiviewer Layout area
 - Multiviewer Menu > Modifier area
 - Multiviewer Menu > Adjustment area
 - Multiviewer Menu > Adjustment area > Output Color
 - Multiviewer Menu > Adjustment area > Window adjustment
- Controller Menu
- Settings Menu
 - Settings Menu > Web App area
 - Settings Menu > Web App area > Dashboard
 - Settings Menu > Web App area > Tools
 - Settings Menu > Web App area > Tools > Manage Software
 - Settings Menu > Web App area > Tools > Backup & Restore
 - Settings Menu > Web App area > Help
 - Settings Menu > Web App area > Contact us
 - Settings Menu > Web App area > Follow us

6.1 General requirements

System requirements for Microsoft Windows

Minimum hardware specifications :

- Intel I5, 2 core
- 4 GB of RAM
- Free hard disk space: 600 MB
- WSXGA resolution (1280 x 1024)
- Fixed Ethernet connection

Software

- Windows 7, Windows 10

Recommended hardware specifications :

- Intel I7, 4 Core or more
- 8GB of RAM
- Free hard disk space: 600 MB
- AMD or Nvidia GPU
- Full HD Resolution
- Touchscreen
- Fixed Ethernet connection 1Gb

System requirements for Apple Mac

Minimum hardware specifications :

- 2.6GHz
2.6GHz dual-core Intel Core i5 (Turbo Boost up to 3.1GHz) with 3MB on-chip shared L3 cache
- 4GB RAM
- Free hard disk space: 600 MB
- WSXGA resolution (1280 x 1024)
- Fixed Ethernet connection

Software

- OSX 10.10 and above

Recommended hardware specifications :

- Intel I7, 4core or more
- 8 GB of RAM
- Free hard disk space: 600 MB
- Full HD Resolution
- Touchscreen
- Fixed Ethernet connection 1Gb

6.2 Download of Event Master Toolset Software

Overview

The Event Master Toolset Software can be downloaded for free from Barco's website, (URL: <http://www.barco.com>). The software is also available on *myBarco* and login to get access to secured information. Registration is necessary.

If you are not yet registered, click on *New to myBarco* and follow the instructions.

It is not necessary to install any other software.

6.3 Software installation



Currently the EM GUI is available for PCs with Microsoft Win7 or Microsoft Win10, and Apple MACs with OS X. The software will run on other Microsoft and Mac operating systems, but currently Barco only supports software installations with Win7 (or Win10) and OS X computers. Linux version of the software will be available in a future release.

To install on Microsoft Windows

The process of installing your software involves the following steps

1. Browse to the directory where the install program is downloaded.
2. Run the install program and follow the instructions.

Software updates

For a new version of the software, download the zip file and follow the instructions as in the first installation. The new version will be installed on the same location and the previous version will be overwritten.

6.4 Starting up

How to start up

1. Double click on the Event Master Toolset Software icon on your desktop
Or,
click Start → All programs → Barco Folsom → Event Master Toolset Rev x.x (Build xxxxx)

The software starts up with the same look and feel as when it was closed before.



The connection is automatically restored with the Event Master unit if it is still available.

6.5 Screen layout presentation

General

The user interface is organized around a **Menu Navigation bar** at the left of the screen and a **Working area** in the rest of the screen. The layout of the screens is similar throughout the GUI.

In order to explain the layout, we will examine the start-up screen of the **Configuration Menu** and describe the different components. The screens for the other menus follow the same structure and flow.

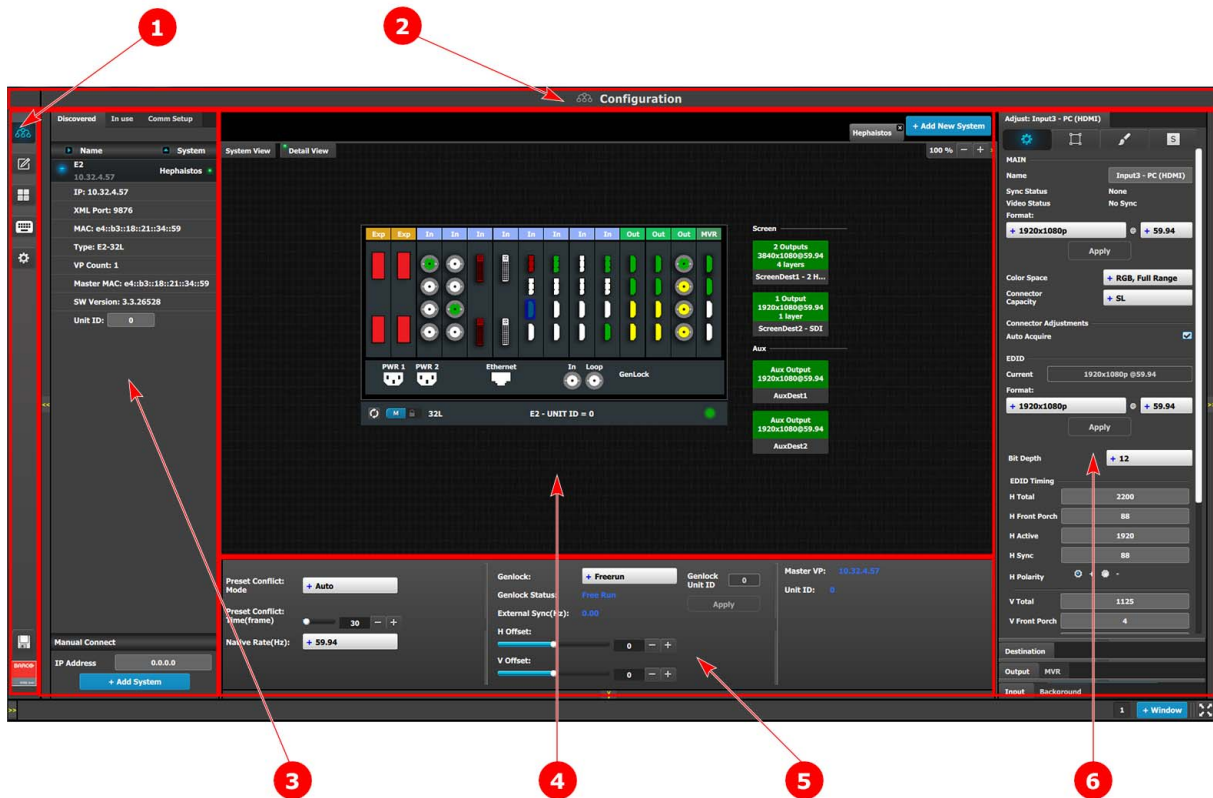

Image 6-1
EM GUI: Configuration Menu

- | | |
|---|---------------------|
| 1 | Menu navigation bar |
| 2 | Title bar |
| 3 | Selection area |
| 4 | Diagram area |
| 5 | Modifier area |
| 6 | Configuration area |

Menu navigation bar

On the far left hand side of the screen is the **Menu Navigation bar** that allows users to navigate between the different screens and save or restore system configurations. This area of the screen is always visible and remains unchanged. The available buttons on the **Menu Navigation bar** are:

- **System Configuration**: allows access to **System Configuration Menu**.
- **Programming**: allows access to **Programming Menu**.
- **Multiviewer**: allows access to **Multiviewer Menu**.
- **Controller**: allows access to Event Controllers setting.
- E2 built-in web page.
- System Save and Restore.

Title bar

On the top of the working area a title bar indicates the name of the selected page (e.g. System configuration).

Selection area

The selection area allows the users to select the System, Device or inputs that will be used.

Diagram area

In the middle, is the Diagram area where the system, Screens and Multiviewer are represented graphically.

Configuration area

On the right hand side, is the configuration area where users perform all needed adjustments.

6.6 Controls

General

Edit box

Edit box is used to edit the values or names.

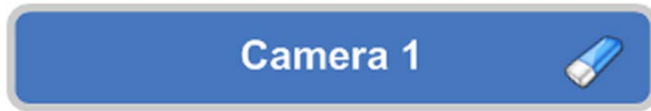

Image 6-2

Properties:

- By double clicking, the background changes to a dark blue color indicating that modifications can be made.
- The cursor is placed on the last character.
- The eraser button allows deletion of all the characters in the edit box.

Slider box

The slider allows modification of the value with slider.

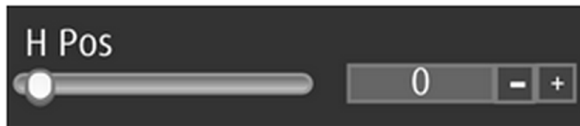

Image 6-3

Properties:

- Slide the cursor to modify the value.
- The value can also be modified by clicking the + or – symbols.

Drop-down menu

A drop-down menu allows the user to choose one value from a list.



Image 6-4

Inactive drop-down

The active drop-down menu, shown in image 6-5, shows the available choices.

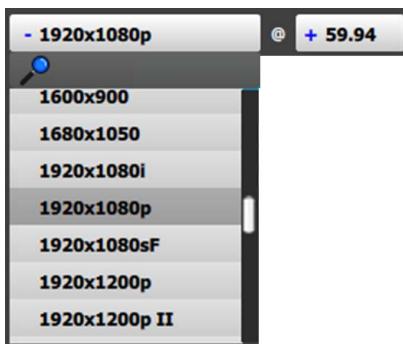

Image 6-5

Active drop-down

Properties:

- When clicking on the + symbol, a drop-down menu appears with the available choices.
- By typing in the space next to the magnifying glass all of the available numbers that match the typed text appear, simplifying the search effort.

6.7 Configuration Menu

General

The **Configuration menu** is the module used to edit the Presentation Systems (creation, modification, deletion). This page is the first page that appears when you launch the EM GUI software.

The user will use this page to add or remove devices to the selected system. The user also could modify the parameters of these devices like inputs, backgrounds, outputs and destinations.

Description

The System configuration Menu is divided in 4 parts:

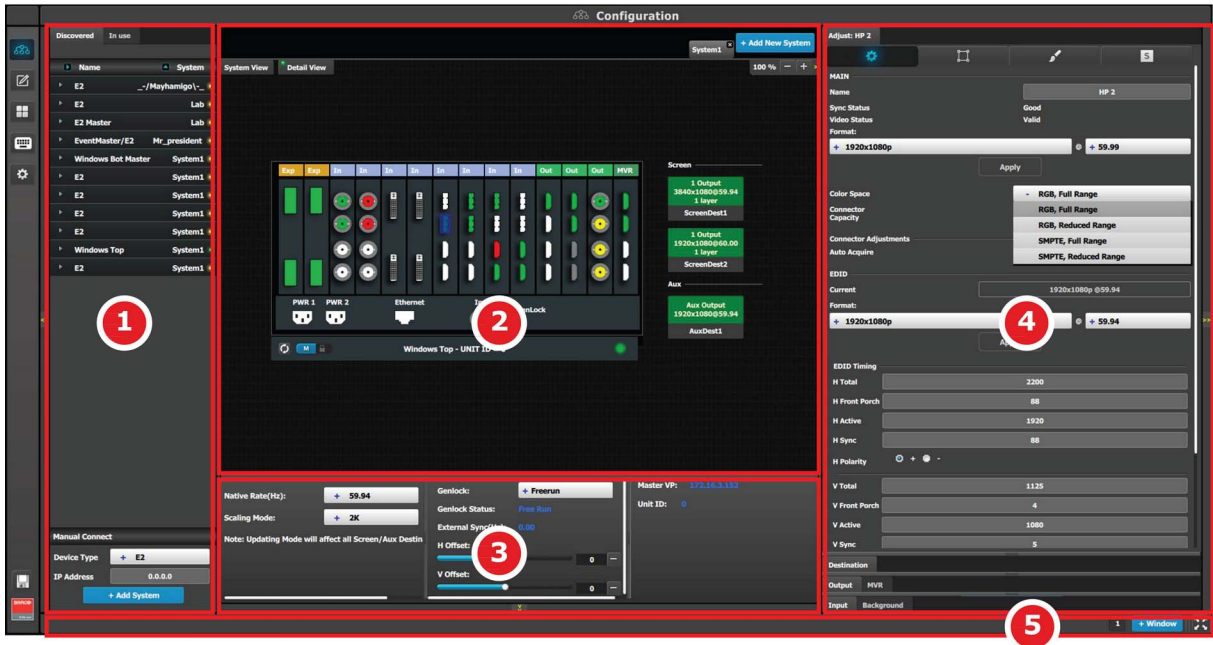
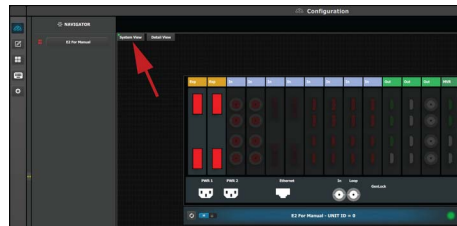

Image 6-6
System Configuration Menu

- | | |
|--------------------------------|--|
| <p>1 Network resource area</p> | <p>Available resources on the network are listed in this area. There are 3 tabs in this section:</p> <ul style="list-style-type: none"> • Devices in use in the selected system. • Discovered devices on the local network. • Simulated devices. |
| <p>2 System diagram area</p> | <p>The workspace has two different views, Detail and System.</p> <p>The selected systems details are graphically represented in this area. To view a different system you select the corresponding tab from the top.</p> <p>When the System is selected an overview of all devices connected to one system is shown.</p> |
| <p>3 System modifier area</p> | <p>System information is displayed in this area. To view a different system you select the corresponding tab from the top. This area also includes Workspace related tools.</p> |



4 Adjustment area

There are several panels in this area: Adjustment, Input/Background, Output/MVR and Destinations. Each panel displays the list of items currently defined in the system. The user can also add or delete and define more items. The adjust tab allows the user to adjust variables in each panel.

Panels can be dragged up or down to allow faster manipulation.

5 Bottom bar

The right side of the bottom bar has control for windows and maximizing the screen. The number indicates if this is window 1 or 2, two is the maximum.



Add a window by clicking the + Window button. The second window can be used on a separate screen.

The out and in arrow button maximizes the interface to the screen, allowing an "OS free" look.

The following sections describe each part of the System Configuration Menu in detail:

- "Configuration Menu > Network resource area", page 108
- "Configuration Menu > System diagram area", page 110
- "Configuration Menu > System modifier area", page 113
- "Configuration Menu > Adjustment area", page 114

6.8 Configuration Menu > Network resource area

General

This part of the System configuration page allows listing devices available on the local network and identifying them.

Description

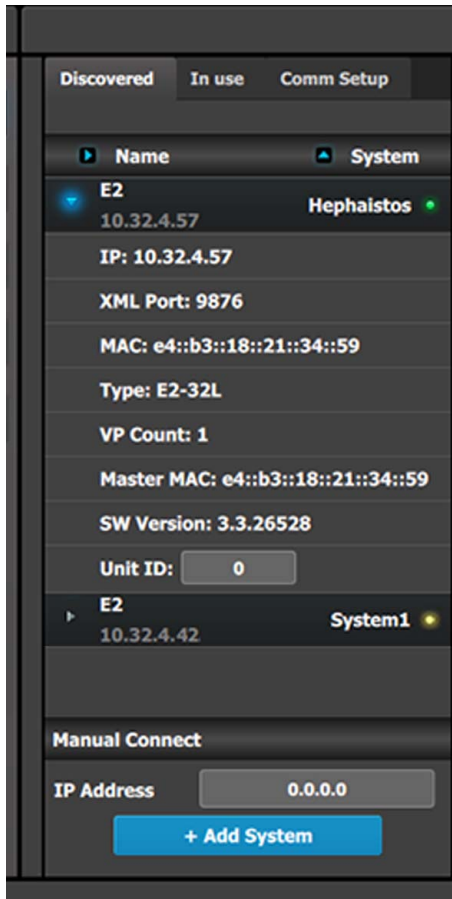

The panel in this area has three tabs:

- **Discovered:** Lists all of the devices discovered on the local network, regardless of the selected System.
- **In use:** Lists the devices in the selected System.
- **Comm Setup:** If the EM GUI is running on an EC-200 controller, this tab detects and shows if an EC-50 is connected to the larger controller.

Note: When the Discovered tab is selected, the Event Master ToolSet Software will continuously send a UDP broadcast over the network to locate devices (every 5 seconds).

Next to the device name an LED indicates the status of the unit:

- **Yellow :** Found in network but not assigned
- **Green:** Assigned and currently has an open or active communication port
- **Red:** Assigned but currently has errors trying to communicate (heart beat communication failure, TCP connection dropped, etc.)
- **Orange:** There is a configuration error with the unit:
 - Input / Output cards not right justified. Refer to the corresponding section below of the card placement rules and error color code.
 - Input / Output configuration mismatch with the actual unit. Refer to the corresponding configuration section of the card placement rules and error color code.

The small arrow in each device opens a detail menu for the device, stating most notably the ID of the unit who is used when units are linked.

In the most of the case, devices are automatically detected and the user just need to add the new device via drag and drop into the system diagram (see **How to add a device into the selected system** below). But, under certain circumstances in Network communication the normal UDP based auto detection of Event Master Compatible Devices might not work. A firewall or a tightly configured switch are examples. In that case a Manual direct TCP/IP request can be sent to a specific IP Address (see **How to manually add a device into the selected system** below).

How to add a device into the selected system

1. Left click on the device to be assigned to the selected system.
2. Drag it to the System diagram area.

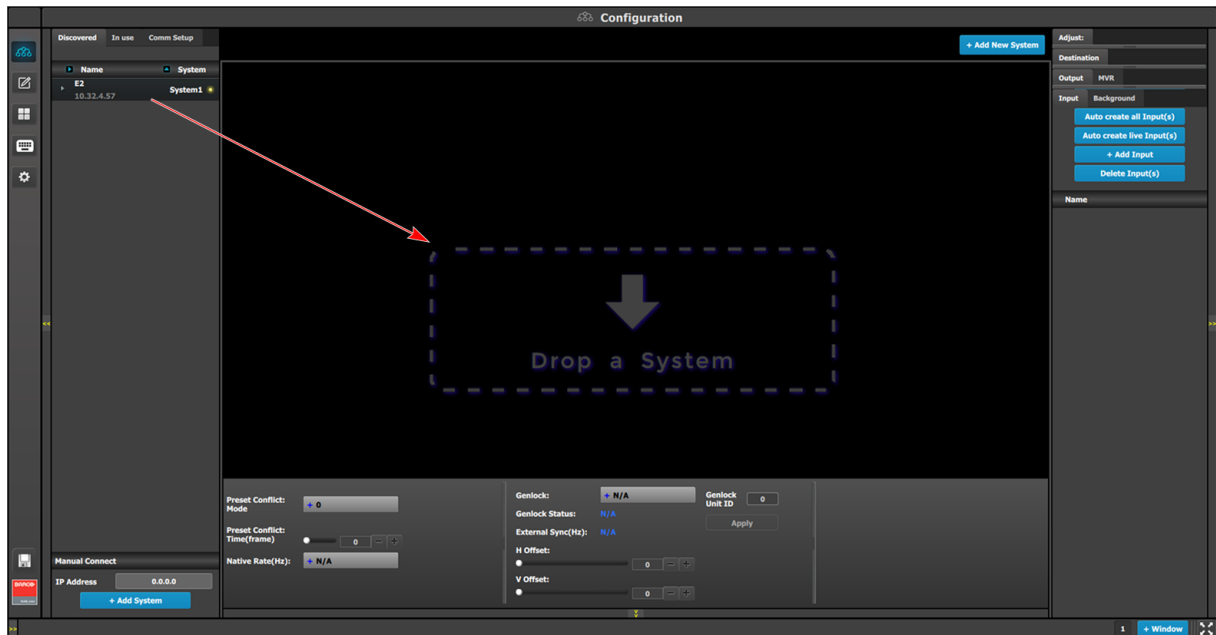

Image 6-7

How to manually add a device into the selected system

To manually add a device, use the “Manual Add” section.

1. Enter the IP address.
2. Press the “Add” button.

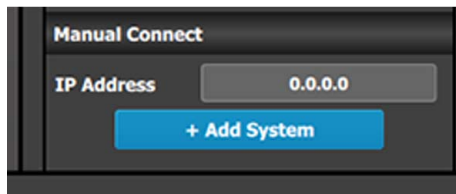

Image 6-8

Unit is added and retrieves the available configuration in the Device.

6.9 Configuration Menu > System diagram area

General

The system is represented graphically in this part of the System configuration page. It is here that the user can select a system (or create a new one), or select a system element (inputs, outputs, destinations ...)

Description

The diagram area graphically represents the devices and destinations that compose the system.



Image 6-9
Diagram area

In this area, the rear panel of the selected system is represented graphically with the cards, and the connectors are color coded to indicate their status.

The color code is:

- White = Connector available to add and configure.
- Gray = Connector capacity set to NONE and is unavailable to add and configure.
- Purple = Connector capacity set to SPLIT; connector 3 mirrors connector 1 (and connector 4 mirrors connector 2), and connector is unavailable to add and configure. Split-mode may be used with the DisplayPort connectors on the quad channel DisplayPort output card and the SDI connectors on the tri-combo output card.
- Red = Signal unavailable and connector configured into system.
- Yellow = Signal available.
- Green = Signal available and connector configured into system.

On the right hand side of the devices is a list of the created destinations (Screen and Auxiliary).

The tabs on the top allow access to the different systems connected to the EM GUI. The last tab allows the users to create a new system.

A set of zoom buttons allows the user to reduce or enlarge the view size. This functionality is very useful when the system is composed of more than one device.

How to create a new system

1. Click on the **Add New System** tab on the top. A new empty tab is created.
2. Drop a device on this system. Refer to the procedure to add a device in the section "Configuration Menu > Network resource area", page 108.
3. Change the system name to avoid confusion when you control more than one system on the same Event Master Toolset Software. Double click on the tab, the tab background changes to a dark blue color indicating that modifications to the name can be made.

How to remove system

1. Click on the "X" button on the system tab.

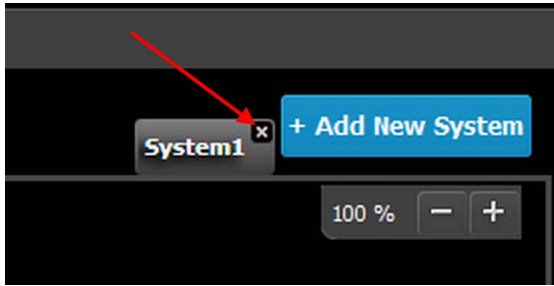

Image 6-10

A confirmation window appears.

2. Click on OK.
The tab is removed.

How to select device in the system

1. Click on the area situated below the Event Master series processor graphic representation.

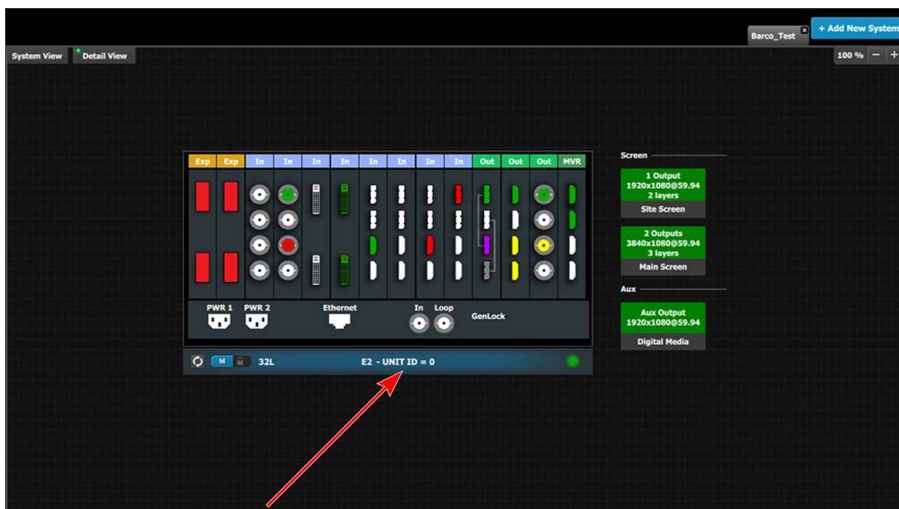
Image 6-11
Device selected

The device is selected. The device is highlighted in blue.

How to select destination (Screen, Aux)

1. Click on a destination (e.g. Aux).

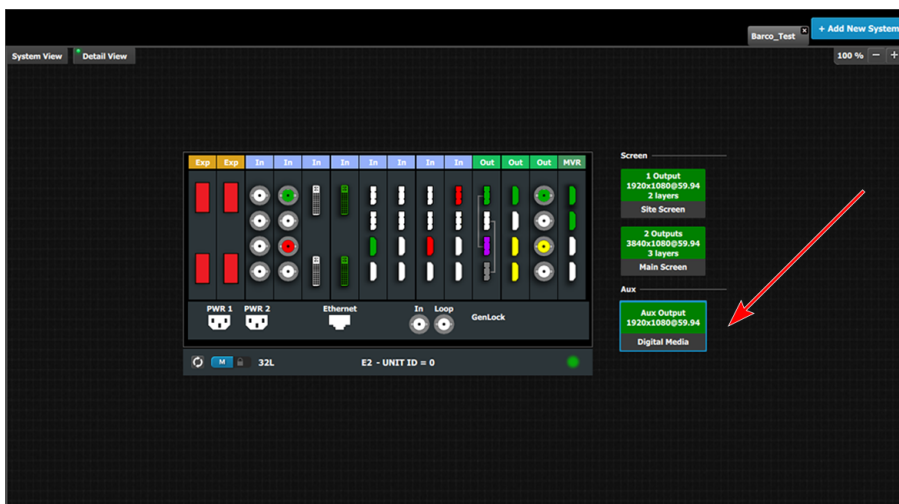
Image 6-12
Destination selected

The destination is selected. The destination is highlighted in blue.



Selecting a device or a destination in the Diagram allows the Adjustment area to display to display the parameters corresponding to the device or destination. See Adjust Tab in the section "Configuration Menu > Adjustment area", page 114.

6.10 Configuration Menu > System modifier area

General

General parameters concerning the selected system are accessible in this area. The user can select the system's preset conflict mode, the native rate, and genlock mode.

Description

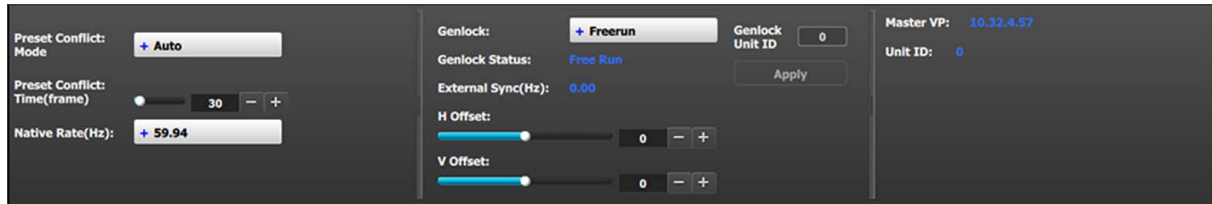

Image 6-13

- **Preset Conflict: Mode**—When using single layers conflicts can arise when a Preset Recall modifies a source layer that is currently on Program. You may choose from three Preset Conflict Modes to resolve these conflicts.
 - **Auto**—The system performs the necessary actions to gracefully recall the Preset to Program.
 - **Force Recall**—The system recalls the Preset directly to Program. Program is not protected.
 - **User Confirm**—The system presents the user with a pop-up asking what to do when a conflict is detected. User Confirm options:
 - **Resolve – All Trans or Cut:** Perform the necessary actions to resolve the conflict and perform an All Trans or Cut to bring the Preset to Program.
 - **Resolve – Wait:** Perform the necessary actions to resolve the conflict and wait for the user to press the All Trans or Cut manually.
 - **Cancel:** Cancels the entire Preset recall operation.
 - **Off**—The system alerts the user with an error message about any Preset recall conflict, but it does not present a pop-up menu for resolving the issue.
- **Preset Conflict: Time(frame)** is the amount of time the system uses when automatically performing an All Trans.
- **Native rate:** System native rate in Hz (Cycles in second). Available selections:

23.98	30	59.94
24	47.95	60
25	48	
29.97	50	

The native system rate needs to match the general frame rate in the event where the unit is used.

- **Genlock mode:** Selects the system genlock mode to **Freerun** or **Lock to External**.
- **Genlock Status:** Reports the system's genlock mode status: Locked or not Locked.
- **H Offset:** The H sync can be offset to match a Genlock situation. Adjustment in mS.
- **V Offset:** The V sync can be offset to match a Genlock situation. Adjustment in mS.
- **Master VP:** Reports the units IP address in the local network.
- **Unit ID:** Reports the units ID number. ID required to identify different units are acting as a single or linked system in order to expand for Inputs, Outputs or Layers.

6.11 Configuration Menu > Adjustment area

General

Situated on the right hand side of the screen is the Adjustment area. In this area the user can define and adjust unit specific parameters, inputs, backgrounds, outputs, multiviewer outputs and destination affected to the selected system.

Description

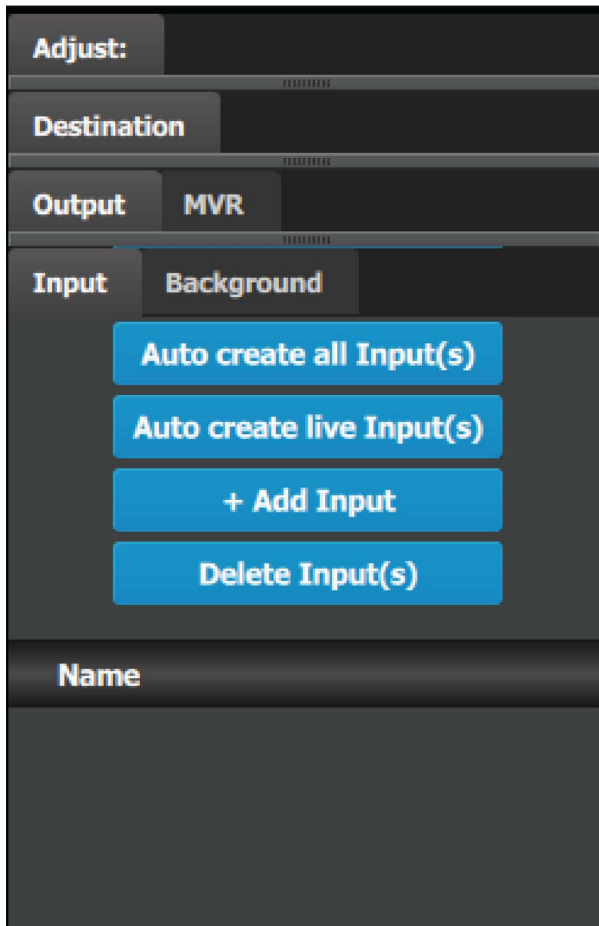

There are 4 tabs in this area:

- **Input:** this tab provides a list of all the created inputs. Here the user can create new entries by associating them with input connectors. It is also in this tab that the user can delete unused or obsolete inputs.
- **Background:** provides a list of backgrounds of the selected system. Similarly to inputs, the user can add and remove Backgrounds from the system.
- **Output/MVR:** the user can add or remove program, auxiliary and multiviewer outputs in this list.
- **Destination:** a destination is a location where the user can route the output of Event Master series processor (screens, widescreens, monitors etc.). The user could assign the outputs that are created in the previous tab to destinations, and deleted unused or obsolete destinations

Always on top:

- **Adjustment:** in this tab the user performs adjustments available for the selected item (device, input, background, output, destination). The content of this tab varies depending on the selected item. Access to this area is achieved from the **System diagram area** (click on device or on a destination) or in one of the tabs of the **Adjustment area** (input, background, output, destination) .

The following sections describe how to perform the configuration of each part of the system in detail:

- "Configuration Menu > Adjustment > Unit Configuration", page 115
- "Configuration Menu > Adjustment > Input Configuration", page 117
- "Configuration Menu > Adjustment > Background Configuration", page 127
- "Configuration Menu > Adjustment > Output Configuration", page 130
- "Configuration Menu > Adjustment > Destination Configuration", page 138

6.12 Configuration Menu > Adjustment > Unit Configuration

General

In the unit configuration adjustments panel, the user can define and adjust unit (device) specific parameters.

How to access the unit configuration adjustments panel

1. Select the device (unit) that you want to configure. Refer to "Configuration Menu > System diagram area", page 110 and see the subsection "How to select device."

The device is selected. The device is highlighted in blue in the **System diagram area** and the name of device is indicated in the **Adjustment** tab in the **Adjustment area**.

2. Click on the **Adjustment** tab in the **Adjustment area**.

The adjustment panel dedicated to the unit is displayed.

Description

Settings tab:

- **Name:** The name of the unit can be edited here.
- **Contact info:** User information for contact person responsible for the unit.
- **SW Version:** Unit's Firmware version.
- **OS Version:** Unit's OS version.
Note: The EM GUI has its Software version shown in the Settings Page.
- **Resets:** (If the user selects one of the reset options, a confirmation pop up appears.)
 - **Soft:** Resets the unit without erasing any stored settings, similar to a Power Off / On.
 - **Factory (Save IP & EDID & ID):** Full factory reset with the exception of keeping the Ethernet setup (IP), the Input EDID settings, and the Unit ID settings.
 - **Shut down:** Powers down the unit.
 - **Factory (Full):** Full factory reset erases all stored settings.
 - **Factory (Save IP):** Full factory reset with the exception of keeping the Ethernet setup.
 - **Factory (Save IP & EDID):** Factory reset, but keep IP and Input EDID settings.
- Ethernet communication setup area.

IP Mode:

Each EMP model has a standard static IP Address.

- E2 (and E2 Jr.) = 192.168.0.175
- S3-4K (and S3-4K Jr.) = 192.168.0.176
- EX = 192.168.0.185

If a DHCP IP address is required, the unit can be set to accommodate that too.

The unit can also have a specific IP Address assigned by the user to match a specific network environment.

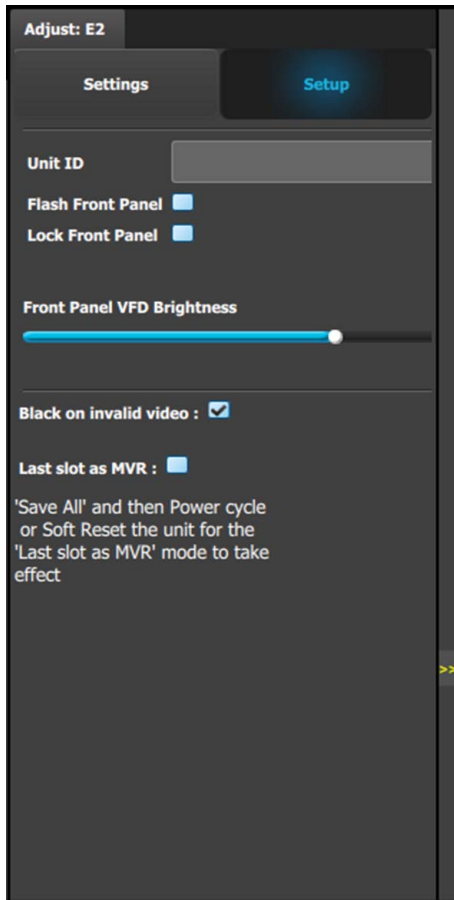

The IP Address is changed by double-clicking on the STATIC setting and assigning an allowed configuration. For details on Network configurations we refer to industry standard.

Setup tab:

- **Unit ID:** Unique unit identification number.
- **Front Panel:** Locks or unlocks the front panel.
- **Front Panel VFD Brightness:** Updates the brightness of the front panel VFD.
- **Black on invalid video:** If checked, when the input timing on the video does not match what was previously acquired on the input connector the video will be set to black.
- **Last slot as MVR:** Allows the operator to use the last slot as an Output or as a Multiviewer (MVR).
 - a) Check or uncheck the 'Last Slot as MVR' checkbox.
 - b) Save the configuration.
 - c) Power cycle or soft reset the unit for the change to 'Last Slot as MVR' to take effect.
 - To soft reset the unit, go to the Reset section of the Adjust > Settings panel and select 'Soft.'

Note: 'Last slot as MVR' is the default setting.

Last slot as MVR or Output in the simulator

To toggle between using the last slot on the simulator as an Output or as an MVR...

1. Check the "Last slot as MVR" checkbox in the Setup panel, and press "Save All" to save the settings.
2. Shut down the simulator.
3. Edit the simhw.xml file.
(You may use any XML editor. You may also use Notepad.)
4. Change the card type of the MVR slot to be either a normal HDMI output card (card type = 22) or an MVR card ((card type = 40).
Last slot as MVR: `<card id="CardID15" type="40" slot="13">CardType_Output_Multiviewer</card>`
Last slot as Output: `<card id="CardID15" type="21" slot="12">CardType_Output_4_SDI</card>`

6.13 Configuration Menu > Adjustment > Input Configuration

General

In the Input configuration menu users can assign input connectors to inputs and adjust parameters to match the incoming signal format and timing parameters.

Input Card arrangement

On the E2 model, the input cards occupy slots 3 through 10 and are right justified to slot 10.

On the S3–4K model, the input cards occupy slots 4 through 6 and are right justified to slot 6.

If there is an empty input slot between two input slots, all input cards to the left of the empty slot are marked with red. Red indicates that although the cards will operate properly, inputs from these cards will not be available at the Multiviewer.

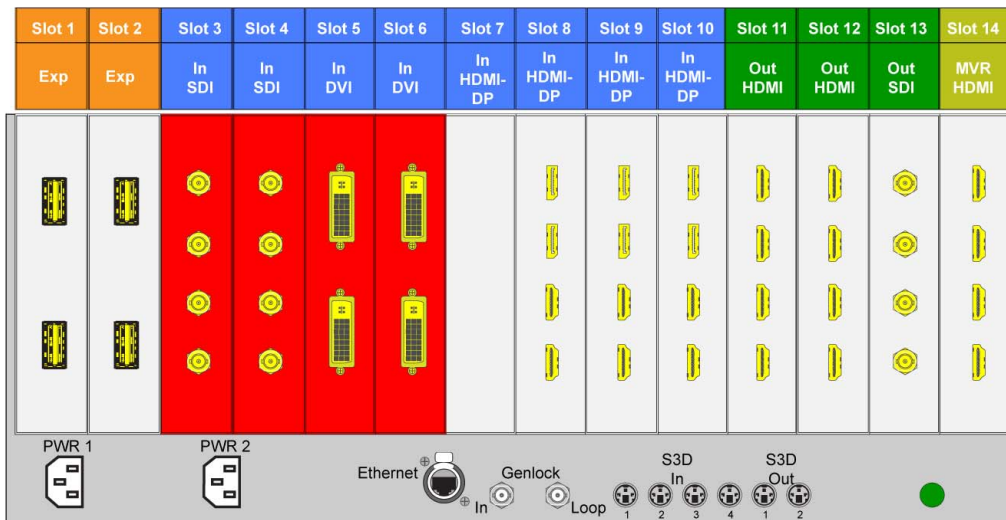

Image 6-14

E.g. E2 with an empty input-card slot

If the card in the slot is wrong type (e.g. output card in input slot, or vice versa) then the slot in the diagram will be greyed out.

Input Connector Grouping

The reason for connector grouping is that in order to accommodate higher resolutions with no loss of quality bandwidth has to be added to the signalpath. By combining connectors a higher resolution all the way up to 4K@60Hz with progressive scan can be added with its full color space 4:4:4.

There several rules that applies when defining an input configuration:

1. Every Input connector can only be assigned to one input.
2. Input types in the same configuration must be of the same type and in the same slot or in adjacent slots. For example, cannot have a HDMI connector and an SDI connector in the same input configuration. Exception to this is the HDMI and DVI connectors.
3. An input can be defined from one, two or four connectors.
4. A grouped connector is still ONE input.
5. Once an input connector is assigned to an input that already contains another one.
6. Maximum of 4 connectors can be assigned to a layer, Input.
7. Maximum of 8 connectors can be assigned to a background, Background.
8. Maximum of 128 input configurations can be assigned.

Examples of 4K Valid Inputs:

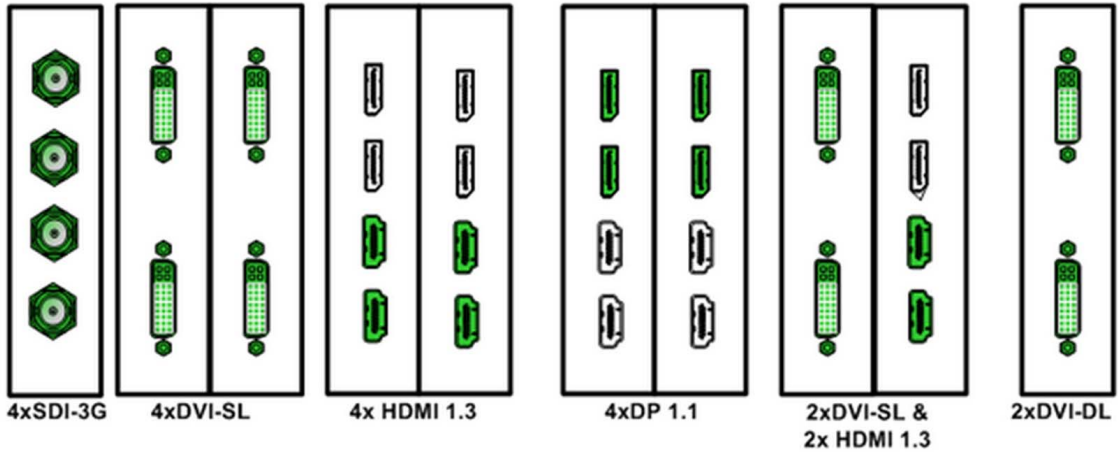

Image 6-15

Examples of valid 3D* Inputs:

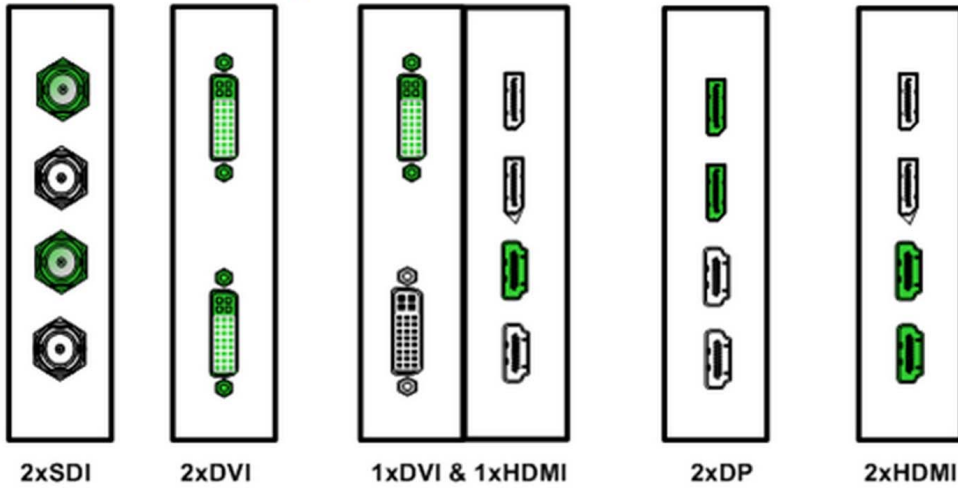





Image 6-16

(*) S3D inputs will be supported in a future software release.

Input connector colors

 White	Not assigned and no input signal is detected
 Yellow	Not assigned to any Source or an input, but a signal has been detected
 Green	Assigned to a source or an input and an input signal is detected
 Red	Assigned to a source or an input, but an input signal is not detected

Input configuration menu description

Input configuration menu is accessed by clicking on the Input tab.

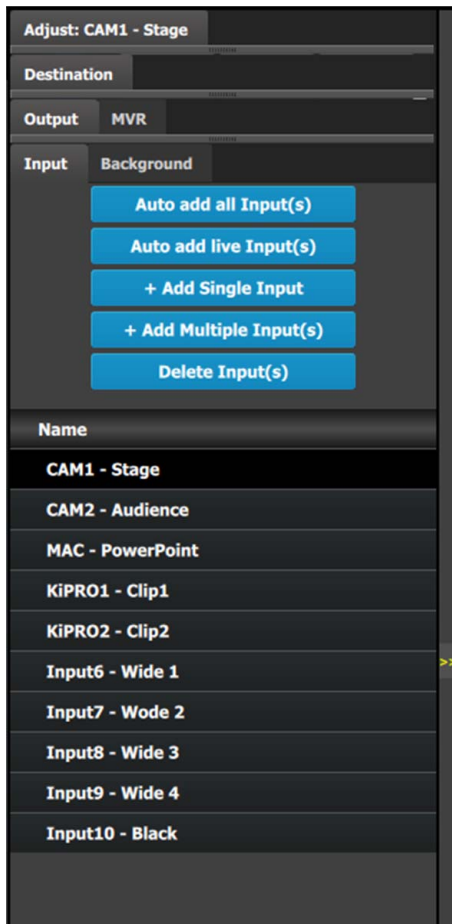

This menu provides:

- **Auto Add all Input(s):** A button to automatically allocate all unassigned input connectors to an input.
- **Auto add live Input(s):** A button to automatically allocate all LIVE input connectors (GREEN) to an input.
- **+ Add Single Input:** A button to manually allocate connectors to an Input configuration.
- **+ Add Multiple Input(s):** A button to manually allocate more than one connector to an Input configuration.
- **Delete Inputs:** A button to delete unused or obsolete inputs.
- A list of all the Inputs already created on the system (e.g. Cam 1, Input2).

Note: Users can now link more than two E2s, or more than two S3-4Ks in a single system. In this configuration, only input expansion is supported. Users can select up to 48 SL inputs for linked E2 systems and 24 SL inputs for linked S3-4K systems to be marked it as a "Global Input."

Global Input checkboxes are available in the Configuration page, under the Input and Background tabs for inputs.

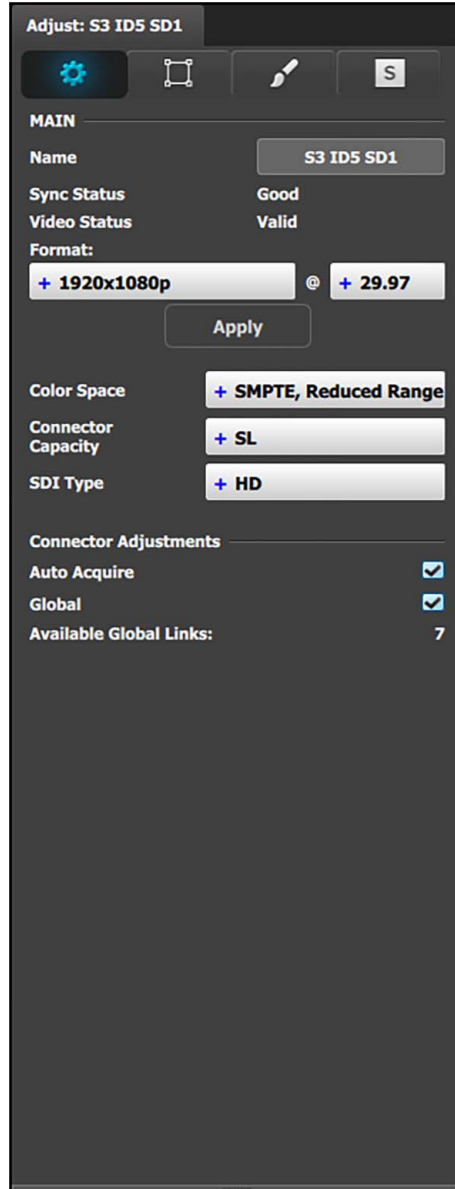
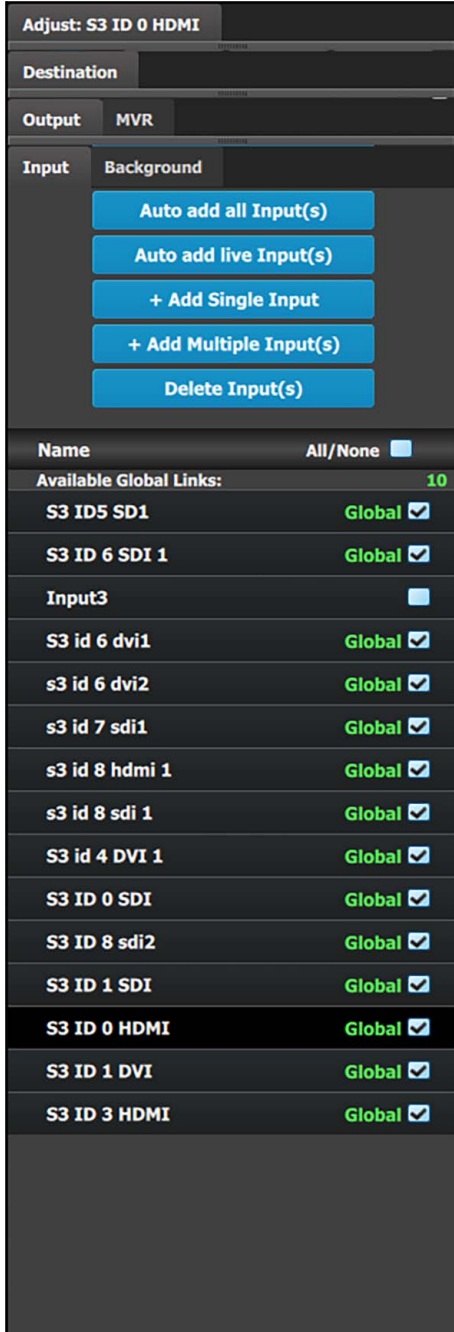

How to Auto add all Inputs

The "Auto add all Inputs" button automatically allocates all unassigned input connectors to an input. At this moment the incoming signal is acquired and a source file is saved. Input connectors that are already assigned to an input will not be affected. If the button is pressed, 28 input configurations will be automatically assigned. The software by default names inputs as "Input 1, 2, 3...". Input configuration names can be renamed by double-clicking on the name and turning the box blue.

How to Auto add live Inputs

The "Auto add live Inputs" button automatically allocates all live input connectors to an input. Input connectors that are already assigned to an input will not be affected. If the button is pressed in the beginning, before any sources has been connected, no

inputs will be automatically assigned. The software by default names inputs as “Input 1, 2, 3....”. Input configuration names can be renamed by double-clicking on the name and turning the box blue.

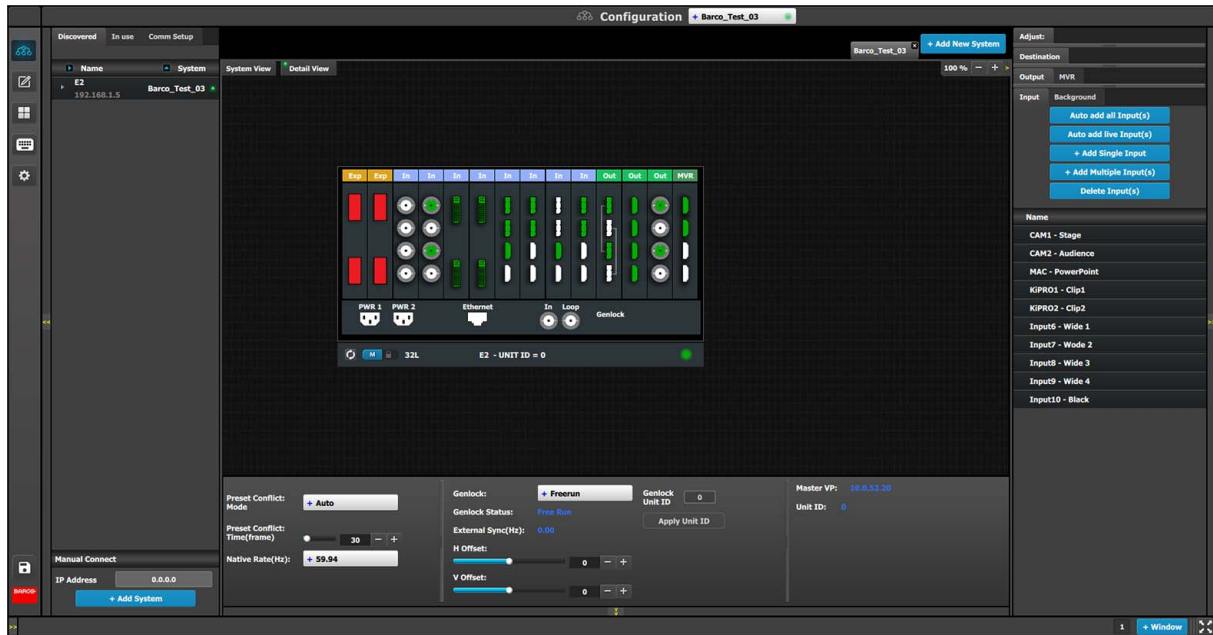

Image 6-17
Configuration menu, Adjustment area, Input

The auto add feature adds only up to 2K resolution inputs. Any special input like S3D and 4K Inputs need to be assigned manually. See **How to add Input** section below.

How to add Input

Inputs configurations can be added manually to un-assigned connectors.

1. Click on the **Add Input** button.

The **Add Input** button is replaced by the **Done Adding** button (highlighted in blue).

2. In the System diagram area, click on the connector(s) that need to be assigned.

Note: If the input signal is 4K provided by the 4 SDI connectors, 4 SDI connectors need to be selected.

Connector(s) is immediately highlighted in blue.

3. The selection is completed by clicking the **Done Adding** button that is highlighted in blue.

A new Input is added in the input list.



To stop the add procedure without add new input, just click on the **Done Adding** button without selecting an input.

How to delete Input

1. Click on the **Delete Input(s)** button

The **Delete Input(s)** button is replaced by the **Delete Selected** button (highlighted in red).

2. Click on the corresponding connector in the graphical area.
Or,
click in the “x” on the right hand side in the input configuration list.

Connector(s) is immediately highlighted in blue.

3. The deletion is completed by clicking the **Delete Selected** button.



Multiple connector configurations can be selected to be deleted together.

How to access to the Input configuration adjustments

Adjustments to inputs are performed in the “Adjust” panel:

1. Select the input from the configuration list
Or,
clicking on the connector graphic.

An input is selected.

2. Click on the **Adjust** tab that is on the top of the Adjustment area.

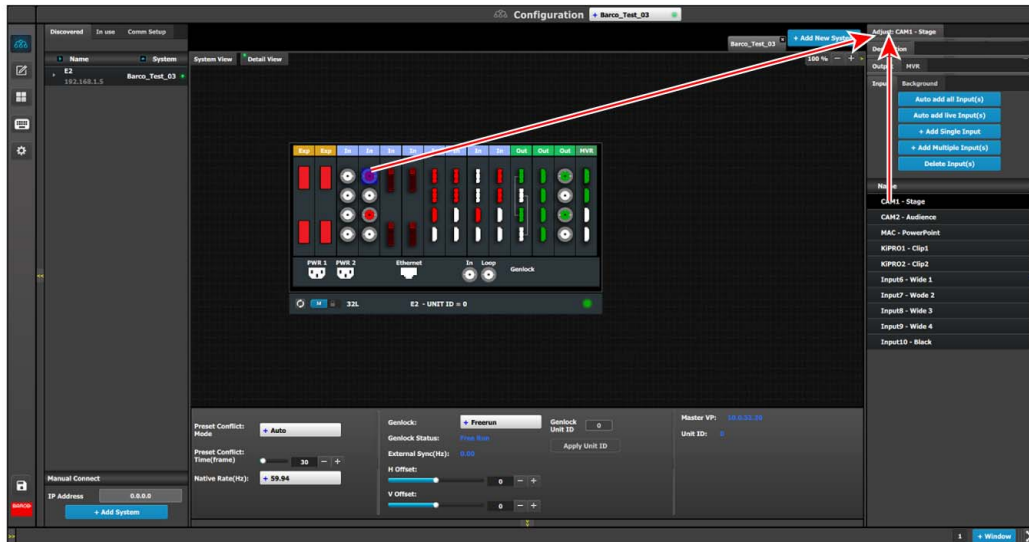
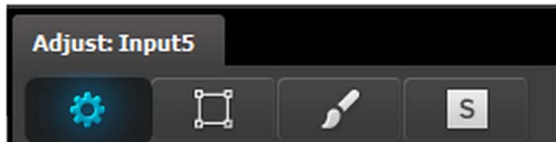

Image 6-18
Accessing the Input Adjust panel

The input adjustment panel is displayed.

Input adjustment panel description

The input adjustment panel is divided in four sections.



- Main page
- Format & Timing
- Color Adjustment
- Contact Information

Input adjustment panel > Main page

This menu is available in two versions according to the input type:

- **DVI, HDMI and DisplayPort** input types

Adjust: Input3 - PC (HDMI)

MAIN

Name: Input3 - PC (HDMI)

Sync Status: None

Video Status: No Sync

Format: + 1920x1080p @ + 59.94

Apply

Color Space: + RGB, Full Range

Connector Capacity: + SL

Connector Adjustments

Auto Acquire:

EDID

Current: 1920x1080p @ 59.94

Format: + 1920x1080p @ + 59.94

Apply

Bit Depth: + 12

EDID Timing

H Total: 2200

H Front Porch: 88

H Active: 1920

H Sync: 88

H Polarity: + -

V Total: 1125

V Front Porch: 4

V Active: 1080

V Sync: 5

V Polarity: + -

EDID: Apply to All Inputs:

Status: Not initialized

HDCP

HDCP Mode:

Status: N/A

Save Input

- Name: Edits the name of the input configuration.
- Sync Status: Detects a good video sync.
- Video Status: Indicates if the Layer capacity is in par with the input resolution.
- Format: The detected video format is shown here. If Auto Acquire is unchecked below, the Wanted video format is selected here from the drop-down menu.
- Auto Acquire: Enables the auto acquire mode. During acquisition, the system detects and acquires the input type and resolution. Refer below for details regarding this feature. Default is **On**
- Colorspace: The detected colorspace is shown here. In the event of a non-VESA standard source the colorspace can be unmatched to the processing. In this case a different colorspace can be selected to accommodate the signal. Available are:
 - RGB, Full Range
 - RGB, Reduced Range
 - SMPTE, Full Range
 - SMPTE, Reduced Range
- Connector Capacity: Each connector has the option to accommodate different bandwidth standards over its interface. This is referred to as:
 - **NONE** The connector is turned off and cannot accept any video, bandwidth of this connector is freed up to be used by another connector. Connector is grayed out in the graphic representation. Connectors need to be selected to NONE before DL or 4K can be selected on others.
 - **SL** Single Link The connector can accommodate a resolution up to 2048 x 1200@60Hz.
 - **DL** Dual Link The connector can accommodate a resolution up to 2560 x 1600@60Hz.
Note: A dual link connector can also accommodate a 3840 x 1080 or 2048 x 2160 signal, that is also available in the EDID list once DL is selected for that input.
 - **4K** The connector can accommodate a resolution up to 4K@30P.
Note: In order to accommodate a 4K@60 signal 2 or 4 connectors need to be used.
- Auto Acquire: Inputs auto acquire incoming video as standard. If the setting is unchecked, only the set or previously acquired signal will be valid video.

- EDID**
 All inputs can have an EDID (Extended Display Identification Data) set according to its connector capacity. The currently set EDID is visible in the Current box.
 Format: The drop-down menu with its search function provide a way to select any of the available VESA or SMPTE standard EDIDs as well as a frame rate. Once selected the Apply Button needs to be pressed in order to program the inputs.
- EDID Timing**
 The EDID timing can be edited into a non standard, or Custom EDID by double clicking on each timing box and inserting a value. A EDID timing needs to follow the VESA rules, and typically a VESA calculator needs to be used.
 Once a value is inserted ENTER needs to be pressed.
 Selected EDID or Custom EDID can be applied to all inputs of the same type at once by selecting the checkbox towards the end of the panel.
- HDCP**
 Enables the HDCP setting for the selected input.
 The default for DisplayPort, DVI, and HDMI inputs is Off. To turn On the HDCP Mode, click on the empty checkbox. When the checkbox displays a check mark, HDCP Mode is On. HDCP Mode is not applicable to SDI inputs.
- SDI input type**

The SDI input configuration menu is similar to the DVI/HDMI/DP menu but without the EDID and HDCP sections. In addition the SDI menu includes an addition selection regarding the SDI type.

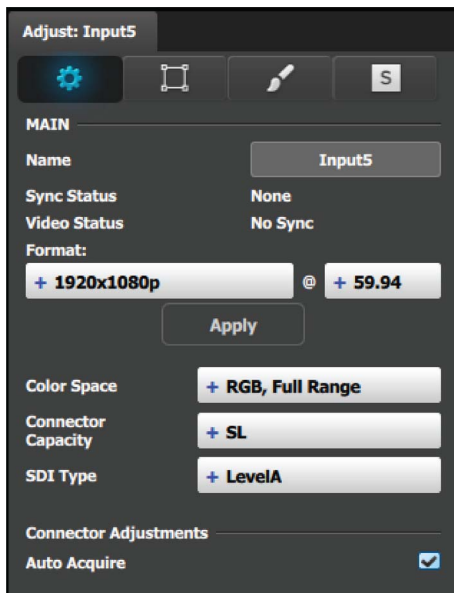

- Colorspace:** The detected colorspace is shown here. In the event of a non-VESA standard source the colorspace can be unmatched to the processing. In this case a different colorspace can be selected to accommodate the signal. Available are:
 - RGB, Full Range
 - RGB, Reduced Range
 - SMPTE, Full Range
 - SMPTE, Reduced Range
- SDI type (available with SDI connector type) :** allows a choice between HD (1.5Gb), 3G (3Gb) Level A, Level B, Level A 2SI, or Level B 2SI.
 The SDI Type options vary, depending on the format of the Outputs. For example, for:
 - NTSC/PAL—the SDI Type can be only SD.
 - 1080i or 1080p, with a refresh rate less than or equal to 30 Hz—the SDI Type can be only HD.
 - 1080p, with a refresh rate greater than 30 Hz—the SDI Type can be:
 - o Level A (default)
 - o Level B
 - o Level A 2SI
 - o Level B 2SI

The 2SI options are available only if the Input/Output configuration has 4 SDI connectors from the same card, and the Output format is either 1920 x 1080 or 2048 x 1080.

Auto Acquire Feature discussion:

When the Auto Acquire is **On**, the system performs a full sync acquisition on the input signal whenever:

- You select an input
- The input type changes
- The sync rate of the input signal changes

During acquisition, the system detects and acquires the input type and resolution. When In Auto Acquire is off, the system uses the last known configuration, when possible. If the input signal is incompatible with the saved configuration, a good input lock may not be possible. In this case, the format name field in the Status Menu displays the Invalid Signal message.

Please note the following important points regarding In Auto Acquire:

- It is recommended that you turn Off Auto Acquire in applications where you have already configured and saved the system's input setup.
- If Auto Acquire is On and a valid input is selected that does not have a saved input associated with it, the system attempts to detect and acquire the source. This process may take a few moments.
- If Auto Acquire is Off, the system uses the last-known configuration for each input, to the extent possible, comparing the input's timing to the configurations in the system's library. These configurations can be custom files or system default configurations.
- Most users can leave In Auto Acquire on. Advanced users who know the input video timing parameters may choose to turn In Auto Acquire off and select the parameters manually.

Input adjustment panel > Format & Timing

This is a status and informational menus. No adjustments can be done on this Format and Timing panel.

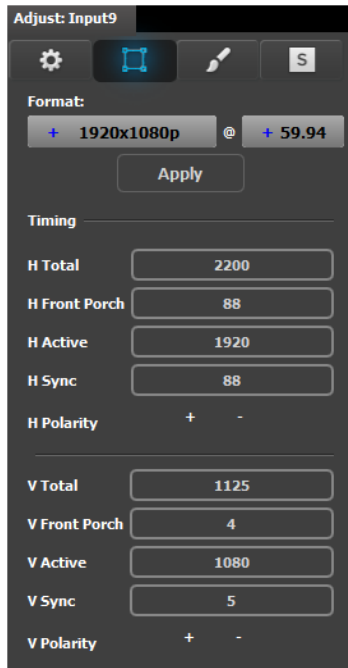

- Format: Video format of the input
- H Total: Total pixel count per line
- H Front Porch: The offset between the end of the active area and the beginning of H sync
- H Active: The horizontal size in pixels of the active area
- H Sync: H sync width in pixels
- H Polarity: Polarity (active High or Low) of the horizontal sync pulse (N/A in SDI)
- V Total: Total line count per frame
- V Front Porch: The offset in lines between the end of the output active area and the beginning of V sync
- V Active: The vertical size of the output active area
- V Sync: V sync width in lines
- V Polarity: Polarity (active High or Low) of the vertical sync pulse (N/A in SDI)

Input adjustment panel > Color Adjustment

This menu allows for color adjustments for each input.

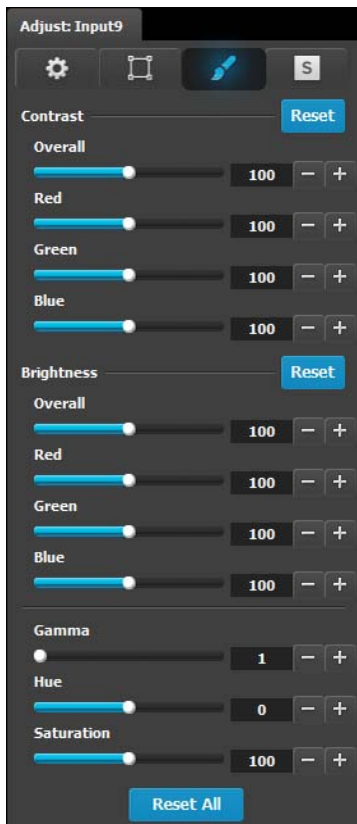

- The RGB Contrast and Brightness settings are adjustable.
 - The Overall adjustment has a range of 50 to 150.
 - The individual Red/Green/Blue adjustments have a range of 25 to 150.
 - The default setting for all of these properties is 100.
- Gamma is adjustable within a range of 0.31 to 3.29. The default setting is 1.0.
- Hue is adjustable within a range of -90 to +90 degrees. The default setting is 0 degrees.
- Saturation is adjustable within a range of 0 to 150. The default setting is 100.
- Reset All changes all values to their default settings.

Input adjustment panel > Contact Information

This menu allows for the user to enter contact information for easy identification.

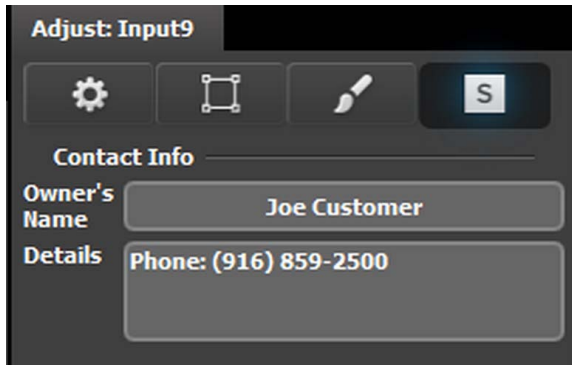

6.14 Configuration Menu > Adjustment > Background Configuration

General

Assigning input connectors to backgrounds is very similar to creating Inputs as it was discussed in the previous section. Therefore, the menus are also very similar and for the sake of simplicity the same menus are not going to be presented in this section.

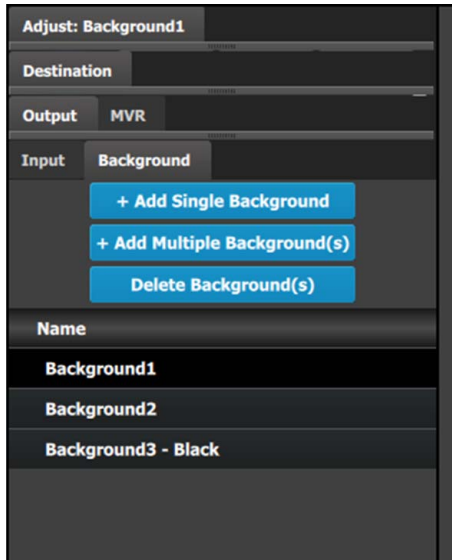

This menu provides:

- **+ Add Single Background:** A button to manually allocate Input connectors to a Background configuration.
- **+ Add Multiple Background(s):** A button to manually allocate more than one Input connector to Background configuration.
- **Delete Backgrounds:** A button to delete unused or obsolete Backgrounds.
- A list of all the Backgrounds already created on the system (e.g. Background1 and Background2).

Note: Users can now link more than two E2s, or more than two S3-4Ks in a single system. In this configuration, only input expansion is supported. Users can select up to 48 SL inputs for linked E2 systems and 24 SL inputs for linked S3-4K systems to be marked it as a "Global Input." Global Input checkboxes are available in the Configuration page, under the Input and Background tabs for inputs.

Backgrounds can also be designated as "Global Inputs" by checking the "Global" checkbox on the Adjust panel for the Background.

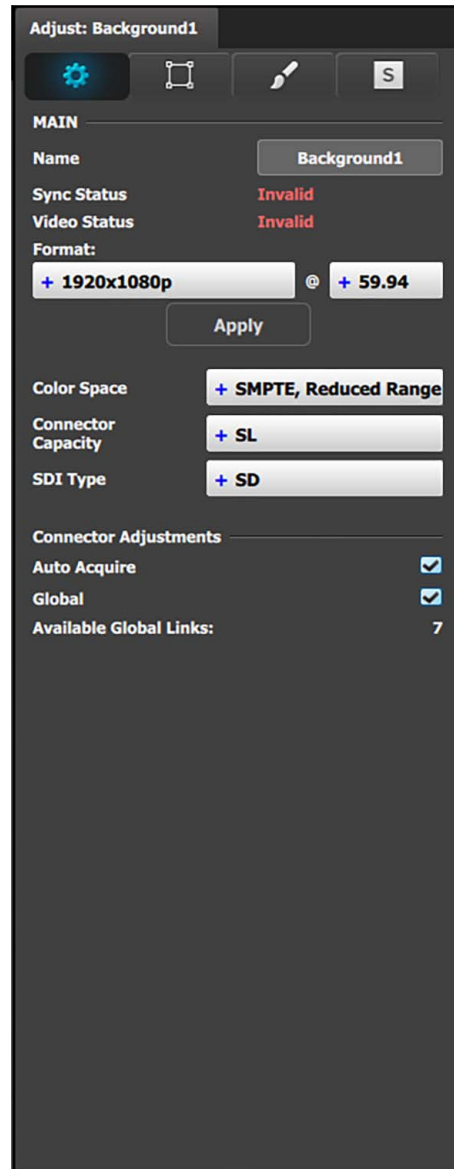
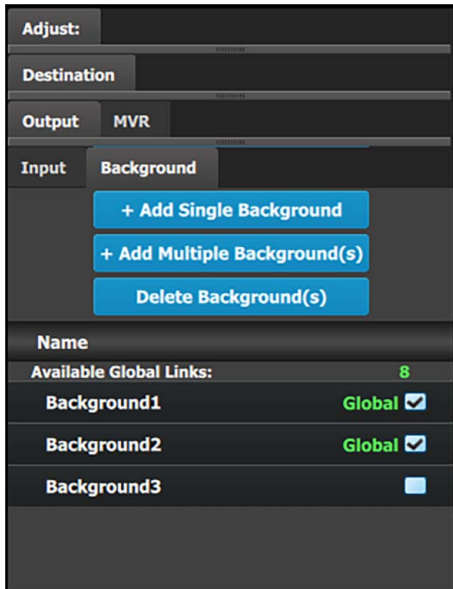

One of the differences between Inputs and backgrounds is in the number of connectors that can be assigned to each one. As it was presented in the previous section, an input can be defined from 1, 2 or 4 connectors. A background channel, however, can be defined by any number of connectors between 1 and 8. The same rules apply as in the Input definition: The connectors need be on the same or adjacent card and be of the same type with the exception of DVI and HDMI that can be defined in the same background.

Backgrounds can be created from all inputs, and as many as you can fit.

Backgrounds can also be inserted through Dual Link capacity, forming a background of one or several 3840x1080 or similar resolutions.

Background Adjustment panel description

If the selected background is composed by more than one input connector, the adjustment menu will include a diagram of the configuration.

The diagram defaults to a horizontal configuration. If a vertical configuration is desired, the user clicks in the circle next to the "V" and then the Apply button.

The Grid (early) or the X by X (later) dialog is used for a background matching a two or more inputs in Horizontal.

Backgrounds must match the output of the Destination they are created for. Future software will allow for re-use of Backgrounds for destination not matching the destinations resolution.

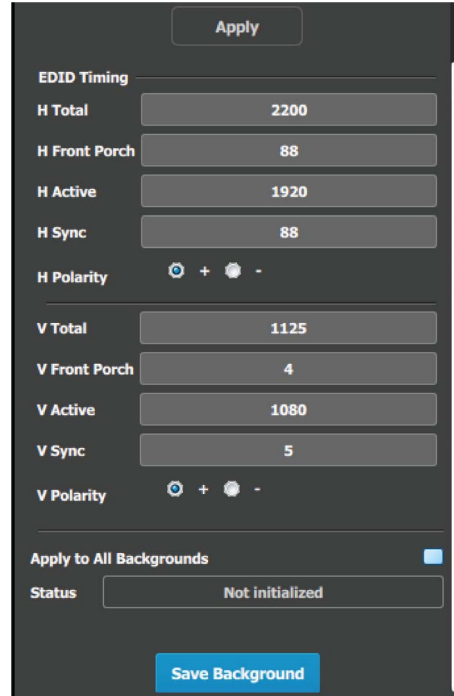
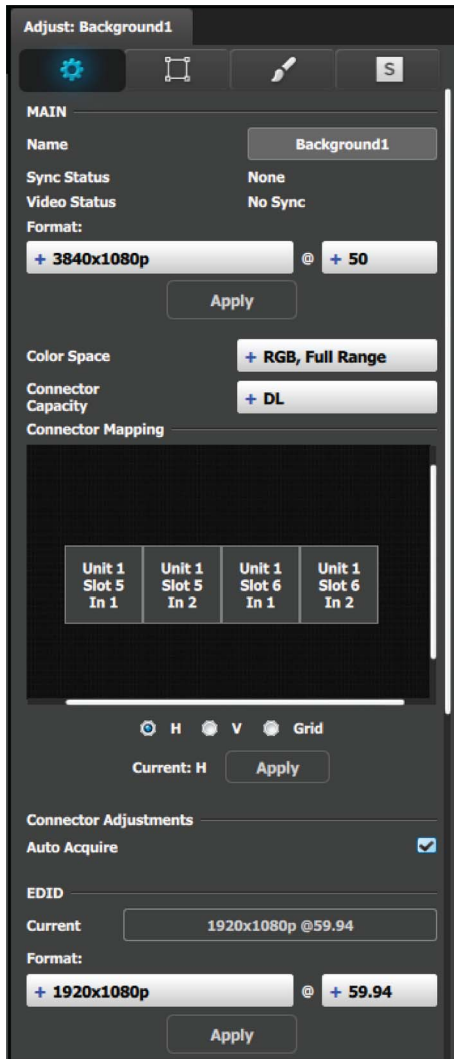

Please note that connector assignments for the backgrounds cannot change from what is shown in the diagram. The system wiring needs to reflect the same order

6.15 Configuration Menu > Adjustment > Output Configuration

General

In the Output menu users can assign output connectors to configurations and adjust signal parameters to match the display devices connected to the unit.

Output Card arrangement

On the E2 model, the output cards occupy slots 11 through 13 and right justified to slot 13.

On the S3–4K model, the output cards occupy slots 7 through 8 and right justified to slot 8.

If there is an empty output slot, all output cards to the left of that empty slot will be red. Red indicates that although the cards will operate properly, outputs from these cards will not be available at the Multiviewer.

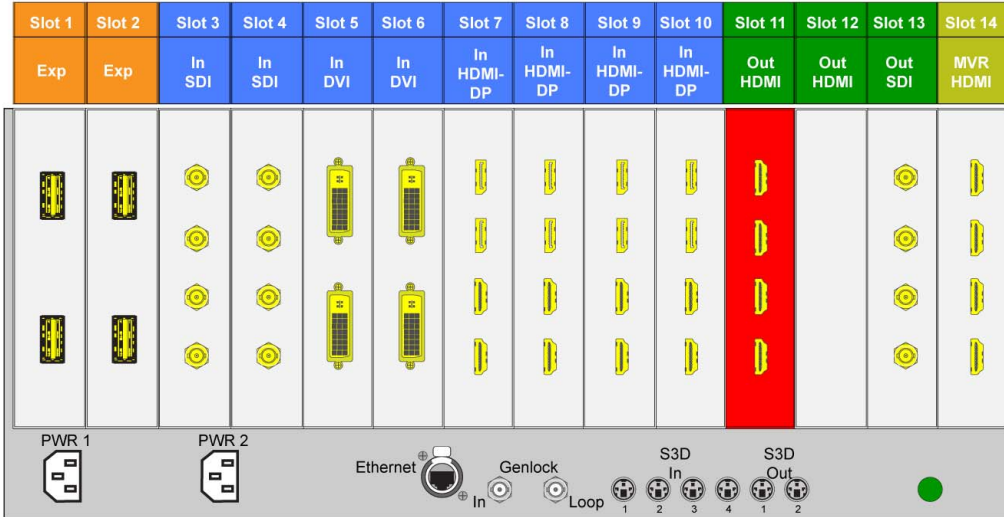

Image 6-19
E.g. E2 with an empty output-card slot

If the card with the connectors that are part of an output configuration is missing, the card in the unit graphic and the output configuration in the configuration list will be greyed out.

Also, if there is an existing output configuration but the card in the slot is of different type, then again the configuration will be greyed out.

Output Connector Grouping

The connectors can also be grouped together to define a 3D* , 4K or Videowall configuration. For example, a projector that requires 2 DVI connectors to pass 3D Left and Right eye signals. Also 4 SDI connectors can be configured as a 4K output in order to connect to a 4K projector.

There are several rules that apply when defining an output configuration:

1. Each Output connector can only be assigned to one output configuration.
2. Outputs in an output configuration must be of the same type AND in the same slot or in adjacent slots. For example, there cannot be a HDMI connector and an SDI connector in the same output configuration.
3. Max connectors for an output configuration = 4.
4. Once output connectors are assigned to the same output configuration, all settings for the output connectors will be synchronized.
5. If an output connector is not assigned to an output configuration,
 - Output settings cannot be adjusted on that connector.
 - The connector cannot be assigned to a destination

Examples of 4K Valid Outputs:

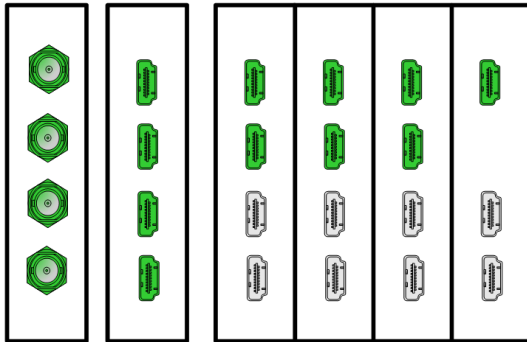

Image 6-20

- 4 x SDI 1920x1080
- 4 x HDMI 1920x1080 or 2048x1080 on 1 card
- 4 x HDMI 1920x1080 or 2048x1080 two cards
- The top 2 x HDMI at 1920 x 2160 or 2048 x 2160 at max 60P
- One of the top HDMI at 3840 x 2160 or 4096 x 2160 at max 30P

Examples of valid 3D Outputs *:

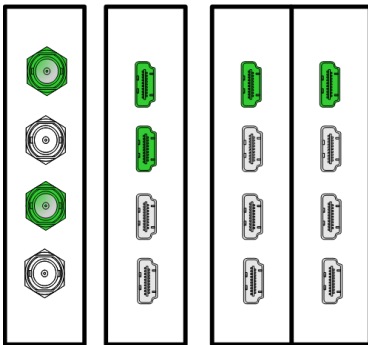





Image 6-21

(*) Future software release

Output connector colors

 White	Not added to system as grouped connector or single connector
 Yellow	Not assigned to any output configuration
 Green	Assigned to an output configuration

Output configuration menu description

Output configuration menu is accessed by clicking on the Output tab.

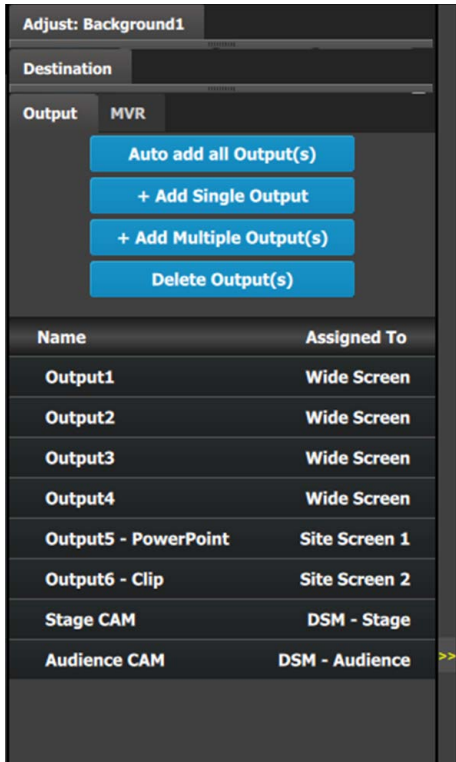

This menu provides:

- **Auto add all Output(s):** A button to automatically allocate all unassigned output connectors to an Output configuration.
- **+ Add Single Output:** A button to manually allocate output connector(s) to an Output configuration.
- **+ Add Multiple Output(s):** A button to manually allocate more than one connector to an Output configuration.
- **Delete Outputs:** A button to delete unused or obsolete Output(s).
- A list of all the Outputs already created on the system (e.g. Output1 and Output2).

How to Auto add Outputs

The "Auto add all Output(s)" button allows all 2K outputs that are not assigned to an output configuration to automatically assign to an output configurations. Output connectors that are already assigned to output configurations will not be affected. The picture below shows what occurs when the button is pressed. Since there are 12 output connectors not assigned, all 12 Output configurations are automatically assigned.

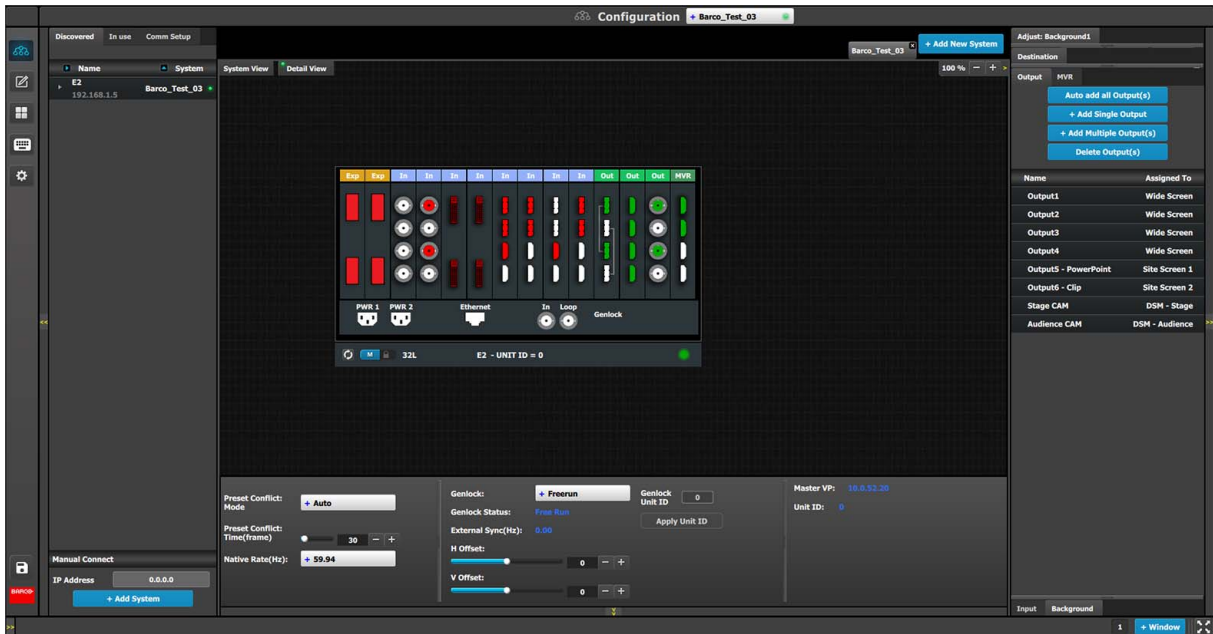

Image 6-22 Configuration menu, Adjustment area, Output

Since the software assigns automatically only 2K outputs, Dual link or 4K outputs need to be configured manually. See **How to add output** section below.

The unit will query the connected device on its output for a preferred EDID and try to assign that as the output resolution and frame rate. If no devices are connected, a standard HD resolution with the native rate of the EMP is assigned as frame rate.

Next to the configuration name is the name of the Destination where the output is assigned. If the Output is not assigned to any Destination, then the name will be "N/A".



The software by default names outputs as “Output 1, 2, 3...” The user can rename each output by double clicking on the name and type in the new name in the blue box.

How to add Output

Outputs configurations can be added manually to unassigned connectors.

1. Click on the **Add Output** button.

The **Add Output** button is replaced by the **Done Adding** button (highlighted in blue).

2. In the System diagram area, click on the connector(s) that need to be assigned.

Note: *If the output is 4K provided by the 4 SDI connectors, the 4 SDI connectors need to be selected.*

Connector(s) is immediately highlighted in blue.

3. The selection is completed by clicking the **Done Adding** button that is highlighted in blue.

A new Output is added in the output list.

How to delete Output

1. Click on the **Delete Output(s)** button

The **Delete Output(s)** button is replaced by the **Delete Selected** button (highlighted in red).

2. Click on the corresponding connector in the graphical area.

Or,

click in the “x” on the right hand side in the output configuration list.

Connector(s) is immediately highlighted in blue.

3. The deletion is completed by clicking the **Delete Selected** button.



Multiple connector configurations can be selected to be deleted together.



You can only delete Output Configurations that are not assigned in Destinations.

How to access to the output configuration adjustments

Adjustments to outputs are performed in the “Adjust” panel:

1. Select the output from the configuration list

Or,

clicking on the connector graphic.

An output is selected.

2. Click on the **Adjust** tab that is on the top of the Adjustment area.

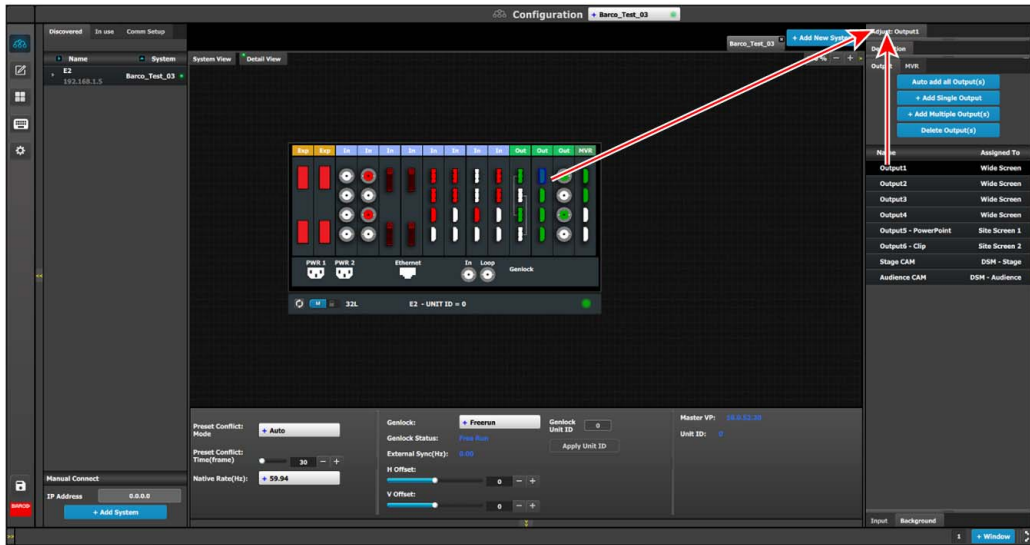
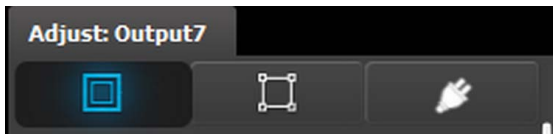

Image 6-23
Accessing the Output Adjust panel

The output adjustment panel is displayed.

Output adjustment panel description

The output adjustment panel is divided in three sections



- Main page
- Format & Timing
- Connector

Output adjustment panel > Main page

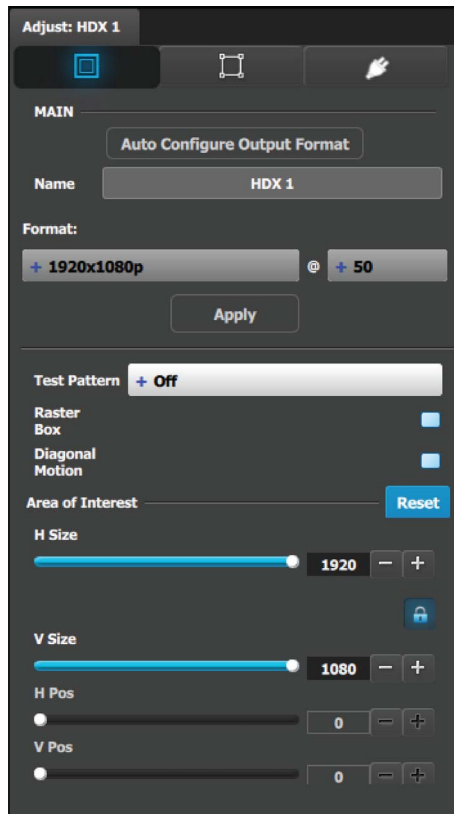

- Auto Configure Output format: Selects the output format will be set to match the format contained in the EDID of the display device connected to the corresponding output(s).
- Name: The name of the output configuration can be edited in this field.
- Format: Selects the video format of the output configuration from the drop-down menu. The available formats are in compliance with the output configuration type. For example, if the configuration is 4K, only 4K formats will be presented in the drop-down menu.
- Test pattern: Turns the Test Patterns ON and select the desired type. The default setting is OFF. Test pattern types :
 - Horizontal Ramp
 - Vertical Ramp
 - 100% Color Bars
 - 16x16 Grid
 - 32x32 Grid
 - Burst
 - 75% Colorbars
 - 50% Gray
 - Horizontal steps
 - Vertical steps
 - White
 - Black
 - SMPTE Bars
 - H Alignment
 - V Alignment
 - H V Alignment
 - Circle Alignment
- Raster box: Turns ON or OFF on a raster around the default active area. This raster box is a white, single-pixel-wide broken line.
- Diagonal Motion: Turns the Diagonal Motion ON or OFF for select patterns
 - The motion is a bottom-right to top-left diagonal for 16x16, 32x32 grid
 - The motion is right to left for 100% Color Bars.
 - There is no motion in Horizontal and vertical Ramps and other patterns
- Area of Interest (AOI): A raster box that can be positioned and sized within the outputs active area, it effectively makes the AOI the new active area. This raster box is a green, single-pixel-wide broken line that helps you adjust the AOI within the output's active area. The handles for the AOI menu are:
 - H Size and V size : Adjusts the horizontal and vertical positions respectively
 - H Pos and V pos: Adjusts the horizontal and vertical positions respectively
 - Note a lock button to allow user to lock the aspect ratio of the size.
- Reset button: resets the AOI to default which is the full output area.

Note: The AOI of AUX outputs works as above while Program outputs will be implemented during 2015.

Output adjustment panel > Timing Menu

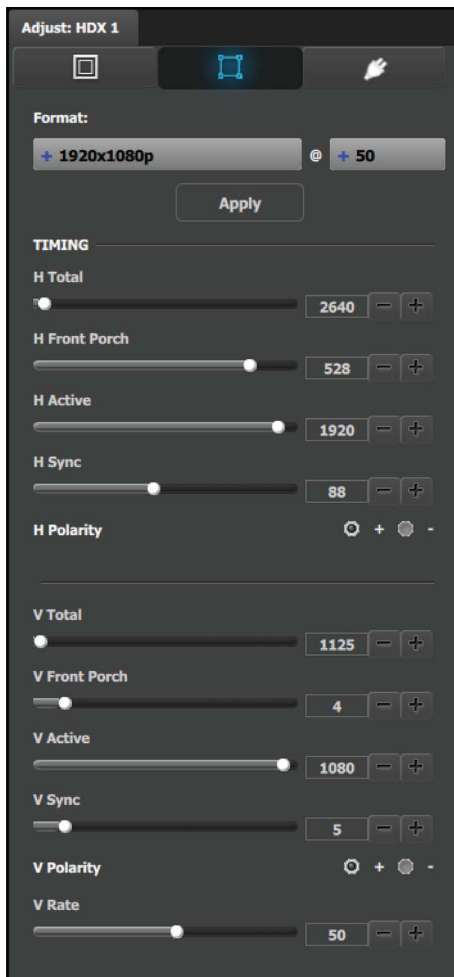

- **Format:** Selects the video format of the output configuration from the drop menu. This is the same adjustment as in the previous menu.
- **H Total:** Adjusts (in pixels) the total pixel count per line for the selected output.
- **H Front Porch:** Adjusts (in pixels) the offset between the end of the output active area and the beginning of H sync.
- **H Active:** Adjusts (in pixels) the horizontal size of the output active area.
- **H Sync:** Adjusts (in pixels) the H sync width.
- **H Polarity:** Adjusts the polarity (active High or Low) of the horizontal sync pulse (N/A in SDI).
- **V Total:** Adjusts (in lines) the total line count per frame.
- **V Front Porch:** Adjusts (in lines) the offset between the end of the output active area and the beginning of V sync.
- **V Active:** Adjusts (in lines) the vertical size of the output active area.
- **V Sync:** Adjusts (in lines) the V sync width.
- **V Polarity:** Adjusts the polarity (active High or Low) of the vertical sync pulse (N/A in SDI).
- **V Rate:** Adjusts the frame rate in seconds polarity (active High or Low) of the vertical sync pulse (N/A in SDI).

Note: Changing these values can make the video signal undetectable for other devices. Always use a VESA timing calculator for best results.

Output adjustment panel > Connector Menu

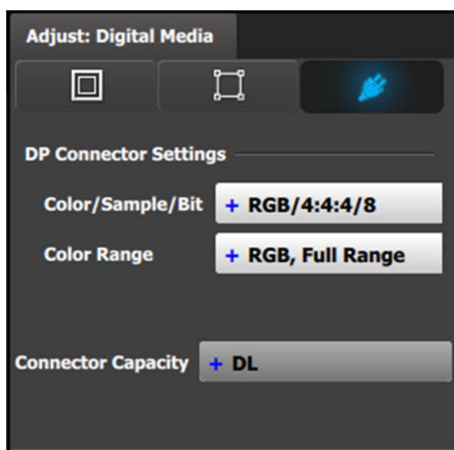

- **Color/Sample/Bit:** Adjusts the color space (RGB or YCbCr), sampling rate (4:4:4) and bit depth (8, 10, or 12) of the output signal.
- **Color Range:** Adjusts the color range (RGB or SMPTE, Full or Reduced).
- **Connector Capacity:** If the connector is not assigned to a Destination as above, the capacity can be changed. Once included in a Destination configuration this needs to be managed thru the Adjust pane of the Destination.

Connector Menu: Output Adjustment—DP

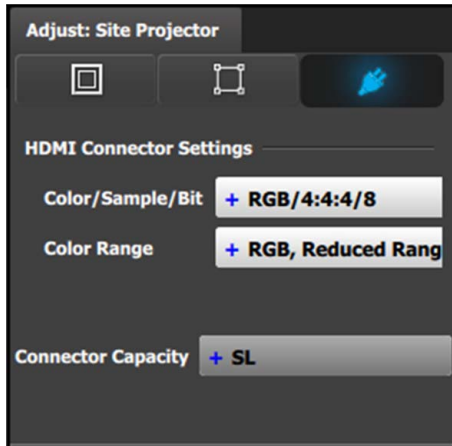

Connector Menu: Output Adjustment—HDMI

- Color/Sample/Bit: Adjusts the color space (RGB or YCbCr), sampling rate (4:4:4 or 4:2:2) and bit depth (8, 10, or 12) of the output signal. Depending on the EDID of the connected device the drop-down list would populate with compatible settings.
- Color Range: Adjusts the color range (RGB or SMPTE, Full or Reduced).
- Connector Capacity: If the connector is not assigned to a Destination as above, the capacity can be changed. Once included in a Destination configuration this needs to be managed through the Adjust pane of the Destination.
- HDCP Mode: HDCP Mode enables the HDCP setting for the selected output. The default for HDMI outputs is Off. To turn On the HDCP Mode, click on the empty checkbox. When the checkbox displays a check mark, HDCP Mode is On. HDCP Mode is not applicable to SDI outputs.

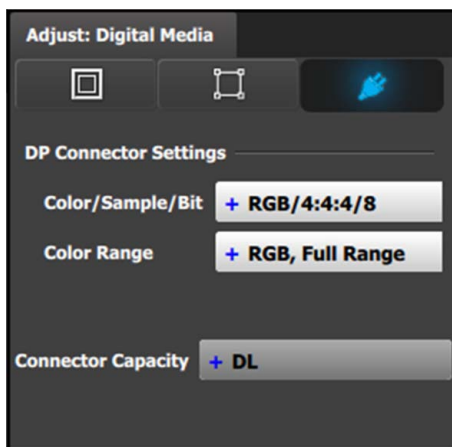

Connector Menu: Output Adjustment—SDI

- SDI type (available with SDI connector type) : allows a choice between HD (1.5Gb), 3G (3Gb) Level A, Level B, Level A 2SI, or Level B 2SI.
 - The SDI Type options vary, depending on the format of the Outputs. For example, for:
 - NTSC/PAL—the SDI Type can be only SD.
 - 1080i or 1080p, with a refresh rate less than or equal to 30 Hz—the SDI Type can be only HD.
 - 1080p, with a refresh rate greater than 30 Hz—the SDI Type can be:
 - o Level A (default)
 - o Level B
 - o Level A 2SI
 - o Level B 2SI
- The 2SI options are available only if the Input/Output configuration has 4 SDI connectors from the same card, and the Output format is either 1920 x 1080 or 2048 x 1080.
- Color/Sample/Bit: Adjusts the color space (YCbCr), sampling rate (4:2:2) and bit depth (10) of the output signal.
 - Connector Capacity: If the connector is not assigned to a destination as above the capacity can be changed. Once included in a Destination configuration this needs to be managed thru the Adjust pane of the Destination.



The selection of HD (1080i) or 3G SDI (1080P) actually happens when the format type is selected in the main tab.

6.16 Configuration Menu > Adjustment > Destination Configuration

General

Output configurations that are created in the previous menus are assigned to destination in the Destination Panel.

Description

Destination configuration menu is accessed by clicking on the Destination tab.

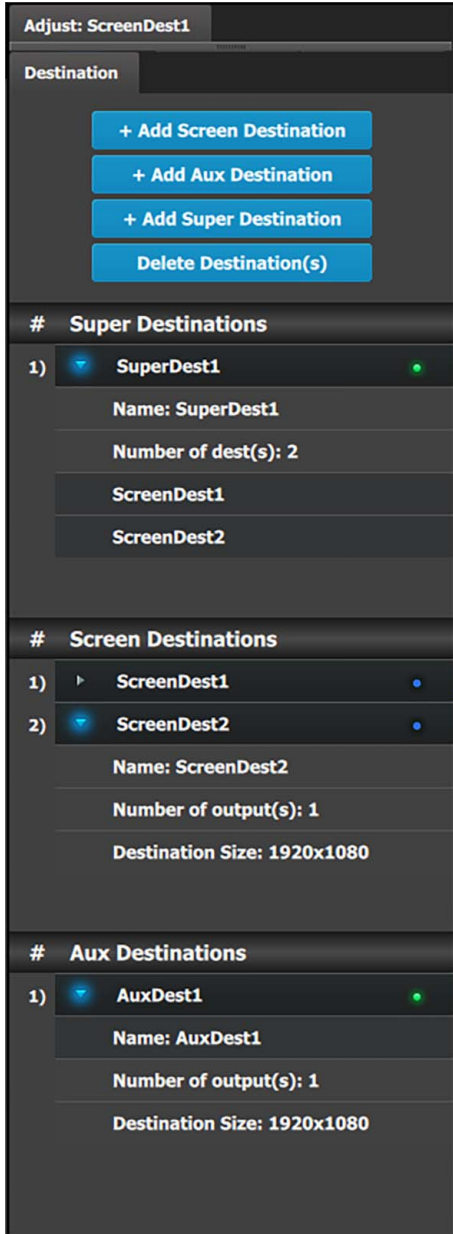

This menu provides:

- A list of all the destinations (Screen, Aux) already created on the system (e.g. ScreenDest1)
- A button to add Screen Destinations.
- A button to add AUX Destinations.
- A button to add Super Destinations.
- A button to delete unused or obsolete Destination(s).

Note: Users can now link more than two E2s, or more than two S3-4Ks in a single system. In this configuration, only input expansion is supported. Users can select up to 48 SL inputs for linked E2 systems and 24 SL inputs for linked S3-4K systems to be marked it as a "Global Input." Global Input checkboxes are available in the Configuration page, under the Input and Background tabs for inputs.

Because Screen Destinations can be inputs to Layers and AUX Destinations, Screen Destinations can also be designated as "Global Inputs." The Destination tab in the Configuration page tracks the number of available global links. To designate a Screen Destination as a global input, check the "Global" checkbox on the Adjust panel for the Screen Destination.

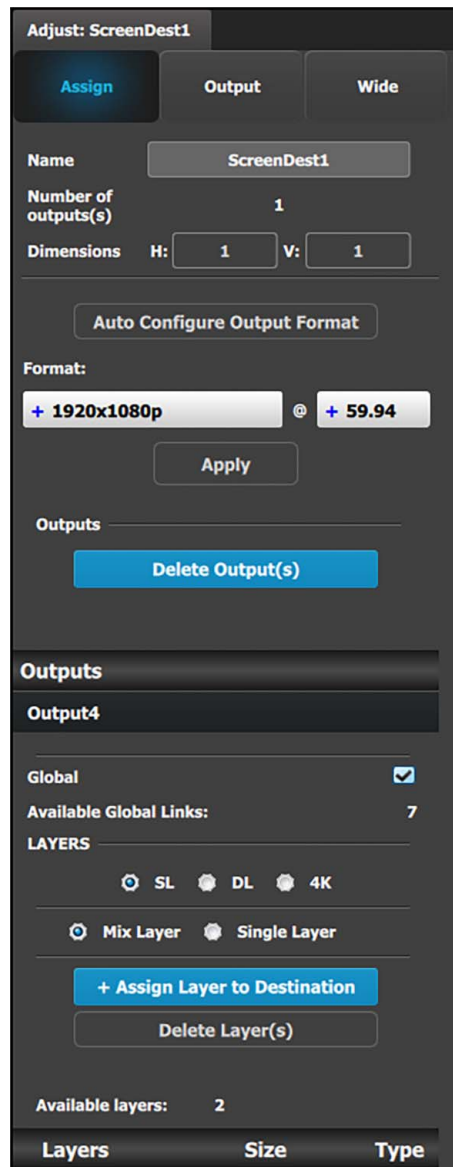
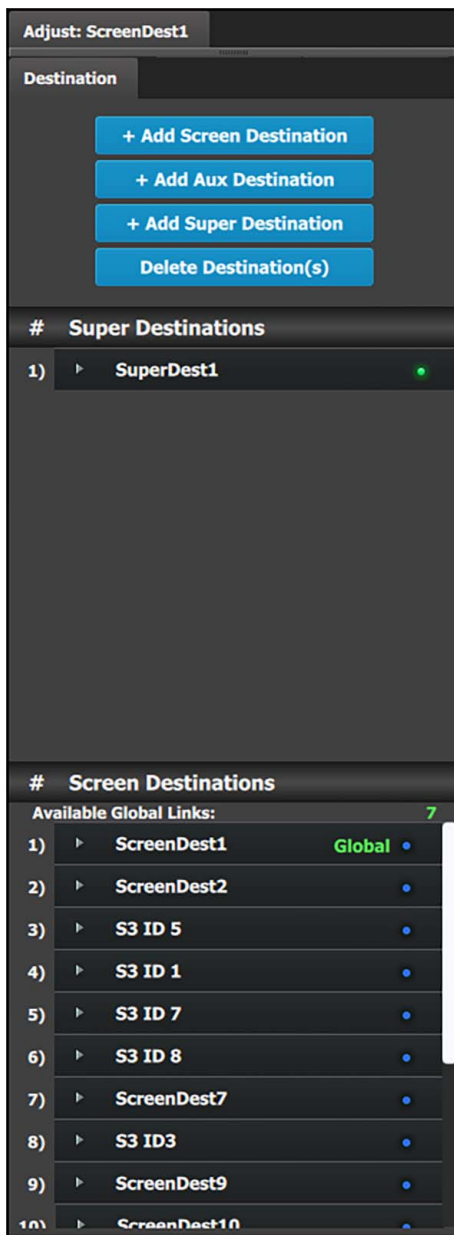

The user can assign Outputs to Output configurations—manually or automatically—and delete Outputs from Output configurations.

Destination formats

Few words about destination formats:

- **For Screen Destinations:** The format of any Output configuration added to a Screen Destination is updated to match the format of the Screen Destination. If the first Output configuration in a Screen Destination is deleted and a new Output configuration is added, then the format of the new Output configuration becomes the format of the Screen Destination.
- **For AUX Destinations:** An AUX destination always assumes the format of the Output configuration that is assigned to it.
- **For Super Destinations:** Super Destinations do not have an output format. As Screen Destinations are added to a Super Destination, the pixels from the Screen Destinations are added together to create the canvas size of the Super Destination. Screen Destinations of different resolutions can be combined into a Super destination. The placement of the individual Screen Destinations need not be edge-to-edge. Screen Destinations can be placed in arbitrary positions, creating a new pixel coordination system and allowing manipulation of Super Layers within that new system.

Rules

The following rules apply when defining a **Screen / AUX Destination** configuration:

1. Destinations accept only the same Output connector types. SDI and HDMI connectors cannot be mixed in the same destination.
2. Destinations accept Output configurations only with the same number of Output connectors. Output configurations with a different number of connectors cannot be combined. For example if the first Output configuration added is an HDMI output configuration with two (2) connectors (grouped connector), an HDMI output configuration with one (1) connector cannot be added to the same destination.
3. One cannot add an output configuration to a destination if it is not capable of using the Output format selected. For example: An Output configuration has a total connector capacity of DL; it cannot be assigned to a 4K destination.
4. Each card can support up to four (4) screen destinations (program outputs), or up to four (4) AUX Outputs, or two (2) AUX and two (2) Screen Outputs.
5. ALL outputs can be AUX Destinations, and all Outputs can be assigned to Screen Destinations.
6. Screen Destination sizes are determined by the available amount of pixel canvas, not by the number of Outputs assigned to a Screen Destination.

More about Super Destinations

As Screen Destinations can be understood as groups of outputs, Super Destinations can be understood as groups of Screen Destinations. Once a Super Destination and more than one Screen Destinations have been created, the Screen Destinations can be assigned to a Super Destination by dragging and dropping them on the Super Destination in the Diagram area of the Configuration menu. Local Layers added to a Screen Destination are added only to that Screen Destination, while Super Layers added to a Super Destination are also added to each Screen Destination in the Super Destination.

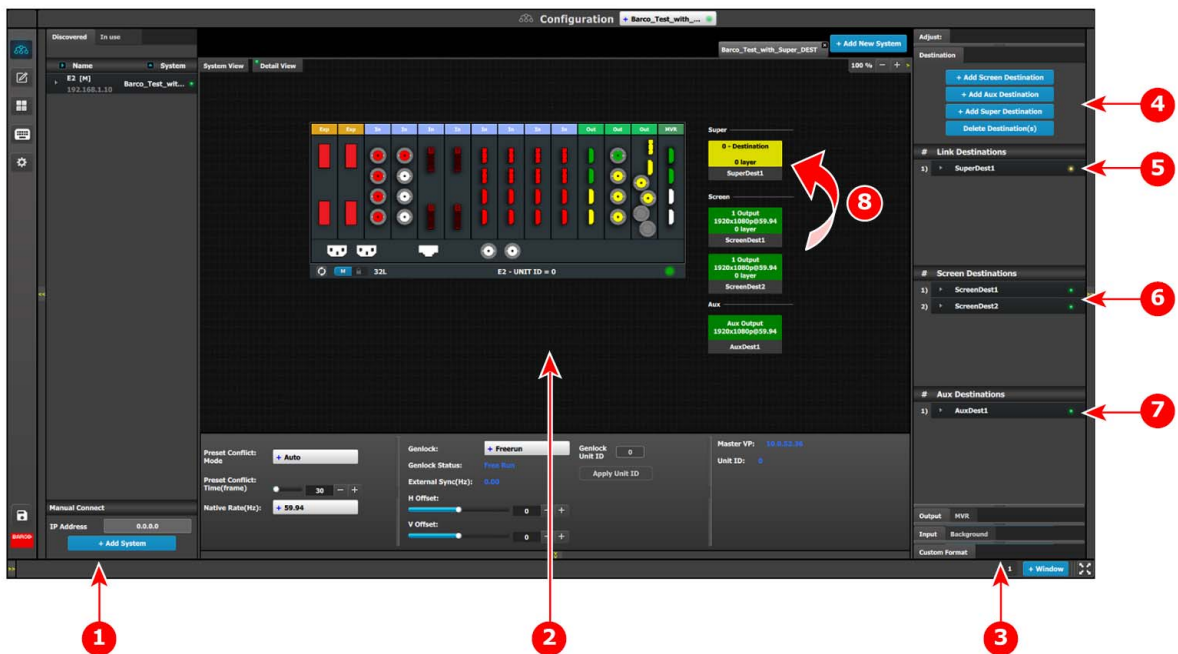

Image 6-24
Super Destinations on the Configuration Menu

1	Network resource area
2	System diagram area

3	Adjustment area
4	Add and delete Destination buttons <ul style="list-style-type: none"> Add Screen Destination Add Aux Destination Add Super Destination Delete Destination(s)
5	SuperDest1
6	Screen Destinations <ul style="list-style-type: none"> ScreenDest1 ScreenDest2
7	AuxDest1
8	Drag and drop ScreenDest1 and ScreenDest2 into SuperDest1.

Creating a Super Destination and assigning Screen Destinations

1. Add Screen Destinations, Super Destination, and AUX Destination, using the add Destination buttons.
2. Assign Outputs to the Destinations.
3. (Optional) Add Super Layers to Super Destinations and Local Layers to Screen Destinations and Local Layers to Screen Destinations.
Layers may be added to the Destinations after the Screen Destinations are assigned to the Super Destination.
4. Drag and drop the Screen Destinations into the Super Destination.

In image 6-25 Screen Destinations 1 and 2 have been assigned to Super Destination 1. (Layers have also been assigned to the Destinations.) Note that the colors of the Destinations in the System diagram area and the colors of the LEDs in the Adjustment area have changed to indicate that the Screen Destinations have been assigned to the Super Destination and that Layers have been assigned to the Destinations.

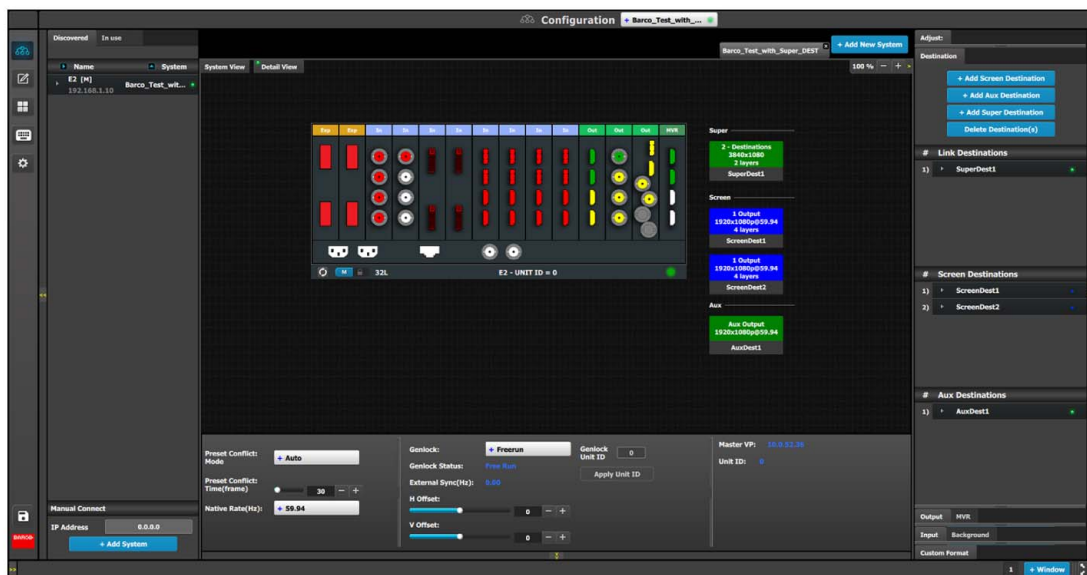

Image 6-25
Super Destination with Screen Destinations Assigned

Manipulating Super and Screen Destinations in the Programming Menu

Use the Programming menu to manipulate Super and Screen Destinations.

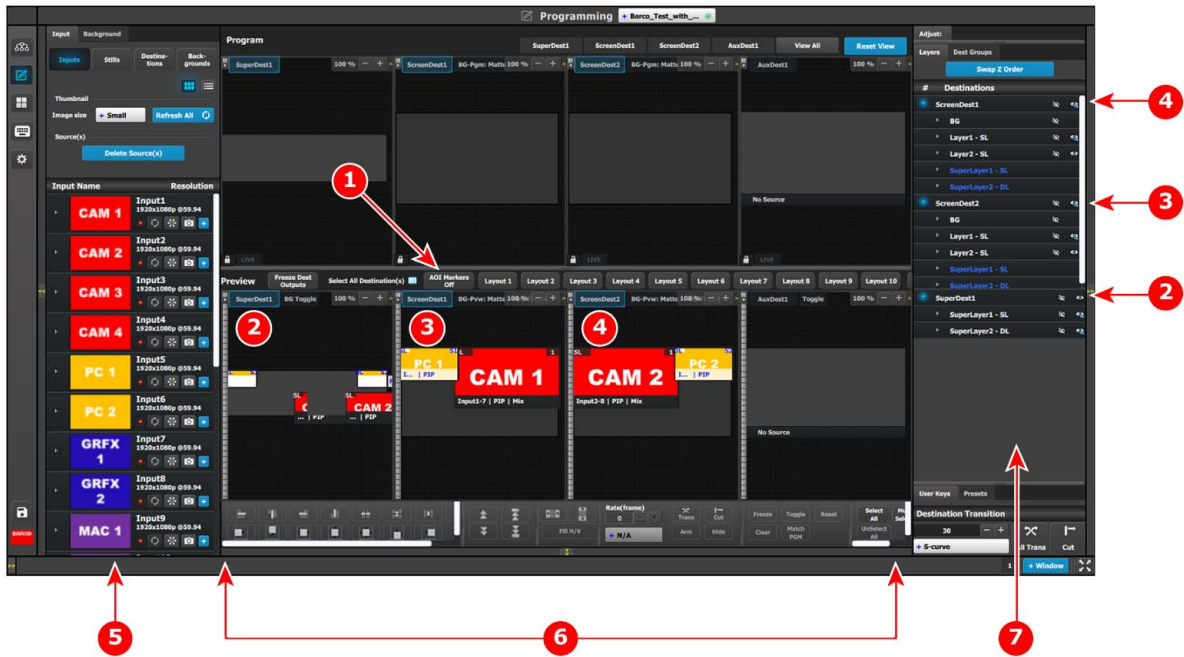

Image 6-26
Super Destinations on the Programming Menu

1	AOI Markers "Off"
2	SuperDest1
3	ScreenDest1
4	ScreenDest2
5	Resources area
6	System-wide functions
7	Adjustment area

- Set the AOI Markers to "Off."
Turning on the AOI Markers "On" or "Off" affects how the system-wide functions (the Layer alignment buttons, including Fill H, Fill V and Fill H/V) work. With the AOI Markers set to "On," the Layer alignment buttons align the Layer into the Screen Destination in which the center of the Layer is located. With the AOI Markers set to "Off," the Layer alignment buttons align the Layer in the entire Super Destination.
- Drag and drop Inputs from the Resources area to desired Destinations.
 - Adding an Input as a Super Layer to a Super Destination adds that Input to one or all of the Screen Destinations assigned to the Super Destination, depending on the placement of the Super Layer in the Super Destination.
 - Adding an Input as a Local Layer to a Screen Destination adds that Input only to the Screen Destination. Super Layers are marked with blue text to differentiate them from Local Layers.
- Apply system-wide functions, User Keys, or Presets to Layers in the Super Destination or in the Screen Destinations.
 - Super Layers must be selected and effects applied in the Super Destination. The EMTS displays the result of the applied effects in the Super Destination and the in the Screen Destinations, but the Super Layers must be selected and effects applied in the Super Destination.
 - Local Layers must be selected and effects applied in the appropriate Screen Destination. The EMTS displays the result of the applied effects in the Screen Destination and the in the Super Destination, but the Local Layers must be selected and effects applied in the appropriate Screen Destination.



The Adjustment area lists Super Layers added to a Super Destination and Screen Layers added to a Screen Destination in white, and it lists Super Layers added to a Screen Destination through a Super Destination in blue.

More about AUX Destinations

Based on the Aux Capacity, the user can create AUX Destination on an output card. The AUX capacity defines the Input capacity and scaler size of the AUX.

All output cards can be Auxes while only any 2 output cards with a total of 8 outputs can be Program outputs

Aux Capacity	Number of Outputs	Max output Resolution
2K (Single Link)	4	SDI 2048x1080 / HDMI 2048 x 1200
Dual Link	2	SDI 2048x1080 / HDMI 2560 x 1600
4K	1	SDI 2048x1080 / HDMI UHD / 4K



For DL resolutions and above only the two top connectors of each HDMI card work.



Widescreen destinations can be downscaled by the Aux and based on the capacity it can accommodate up to eight (8) outputs worth of widescreen.

Color codes

Super Destinations, Screen Destinations, and AUX Destinations are represented graphically in the **Diagram** area.

<div style="background-color: blue; color: white; padding: 2px;">1 Output 1920x1080p@59.94 4 layers</div> <div style="background-color: grey; color: white; padding: 2px;">ScreenDest1</div>	Blue: The destination has been assigned to a super destination.
<div style="background-color: green; color: white; padding: 2px;">1 Output 1920x1080</div> <div style="background-color: grey; color: white; padding: 2px;">ScreenDest1</div>	Green: Output(s) have been assigned to the destination
<div style="background-color: yellow; color: black; padding: 2px;">- Output</div> <div style="background-color: grey; color: white; padding: 2px;">ScreenDest1</div>	Yellow: Output(s) have not been assigned to the destination.

It is possible that after the unit is turned on, the hardware configuration can be altered making certain Destinations to have invalid Output configurations.

In this case the Destination in the System Diagram becomes grey and adjustment are disabled. In this case the destination needs to be deleted and new one created to reflect the existing output configuration.

How to add Destination

To assign an output configuration to a destination, select the output configuration (output Tab) and then click on the **Add Screen Destination**, or the **Add Aux Destination**, or the **Add Super Destination** button (Destination Tab). These buttons are highlighted in blue.

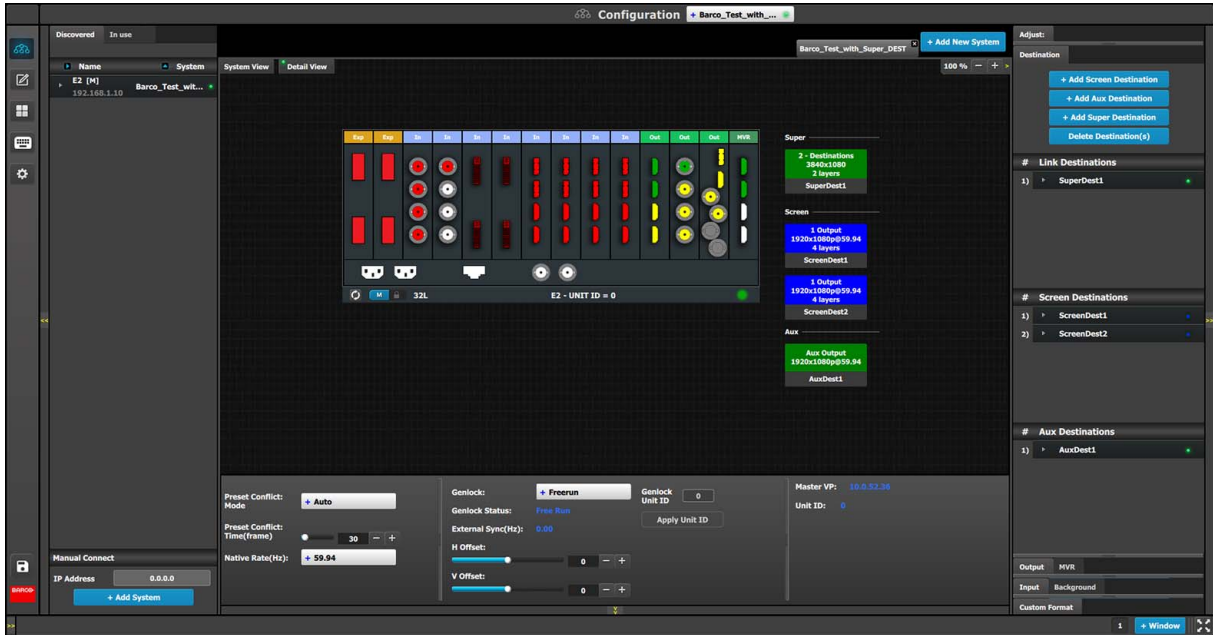

Image 6-27
Add Destination buttons

If the **Add destination** button is pressed without selecting an output configuration, the software will automatically assign the first unassigned output configuration (from left most output card) to a destination. The output configuration format is copied to the destination output format.

New **Screen**, **Aux**, or **Super** destinations can be added as long as there are unassigned output configurations to destinations.

Alternatively, you assign outputs to destinations by dragging them into the output configuration the Destination block. In the example below, the output 1 was assigned to ScreenDest1 and the destination format was set to 1920x1080 reflecting the format of output1.

When output 2 is dragged into the same destination, then the format changes to 3820x1080 reflecting a 2x1 setup. When outputs are dragged into a destination in this manner, the software assumes it is a horizontal setup with 0 pixel overlap. The overlap can be modified in the Wide menu. If a vertical or grid setup is desired, then the output configuration needs to be setup as such in the output configuration menus.

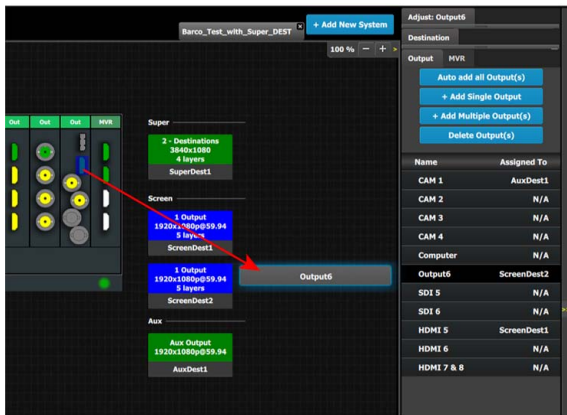

Image 6-28

How to delete Destination

1. Click on the **Delete Destination(s)** button

The **Delete Destination(s)** button is replaced by the **Delete Selected** button (highlighted in red) and the unit diagram is greyed out, except the area dedicated to destinations (Screen and Aux).

2. Click on destination in the graphical area.

Or,
click in the “x” on the right hand side in the destination configuration list.

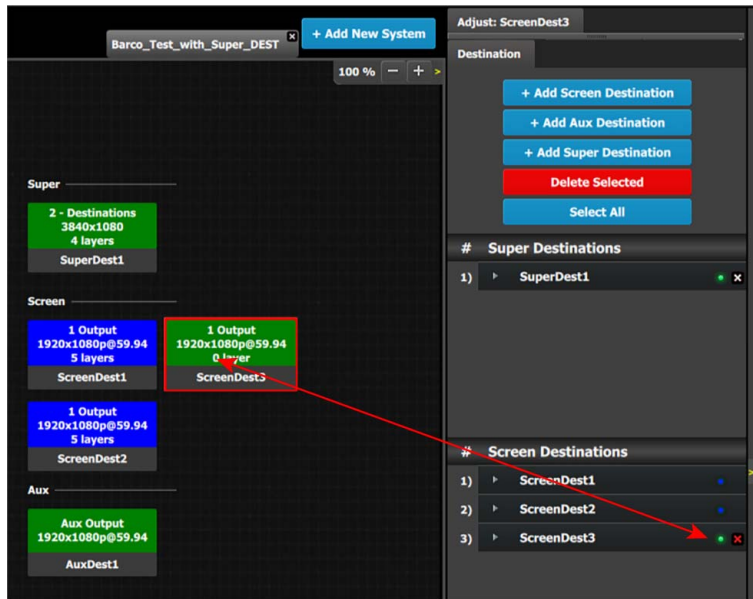

Image 6-29

Destination(s) is immediately outlined in red.

- The deletion is completed by clicking the **Delete Selected** button.



Any output can be deleted from a destination at any time. For example, if the output that is automatically assigned to a destination is not the desired one, then it can be deleted.



All destinations can be deleted the same time by clicking the “Select All” button.

How to access to the Destination configuration adjustments

Adjustments to Destinations are performed in the “Adjust” panel:

- Select the destination from the configuration list
Or,
clicking on the graphic representation the destination in the **Diagram** area.
A Destination is selected.
- Click on the **Adjust** tab that is on the top of the Adjustment area.

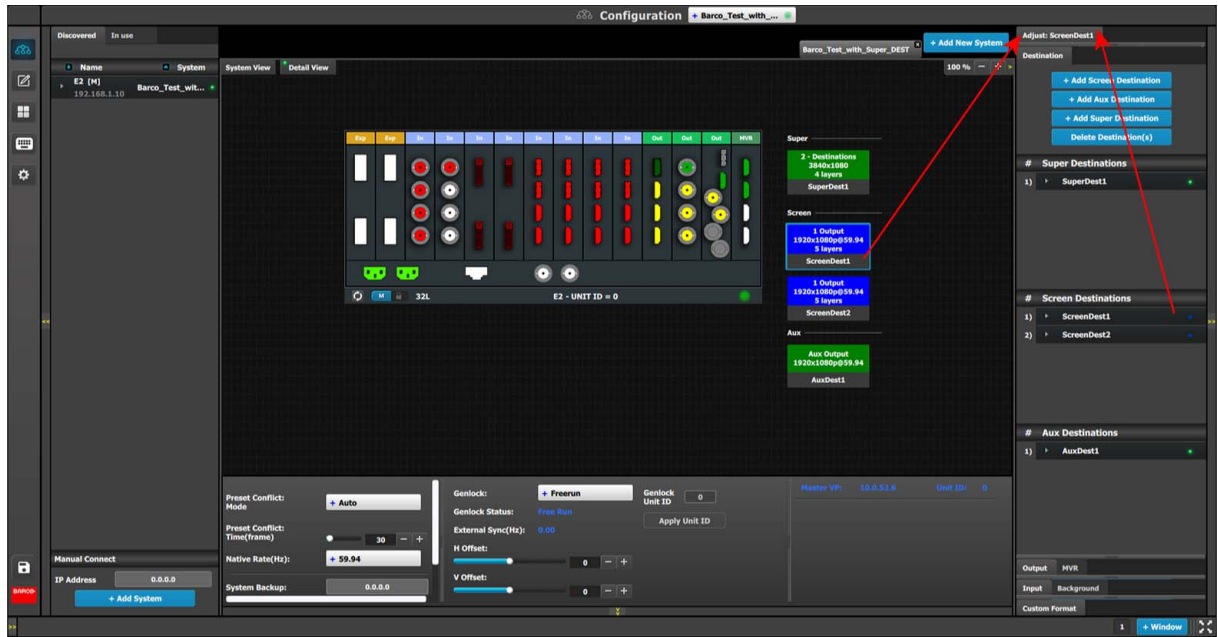
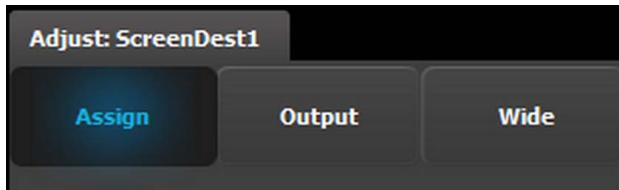

Image 6-30

The **Destination adjustment** panel is displayed.

Destination adjustment panel description

The Destination adjustment panel is divided in three sections:



Assign
Output
Wide

Assign Menu

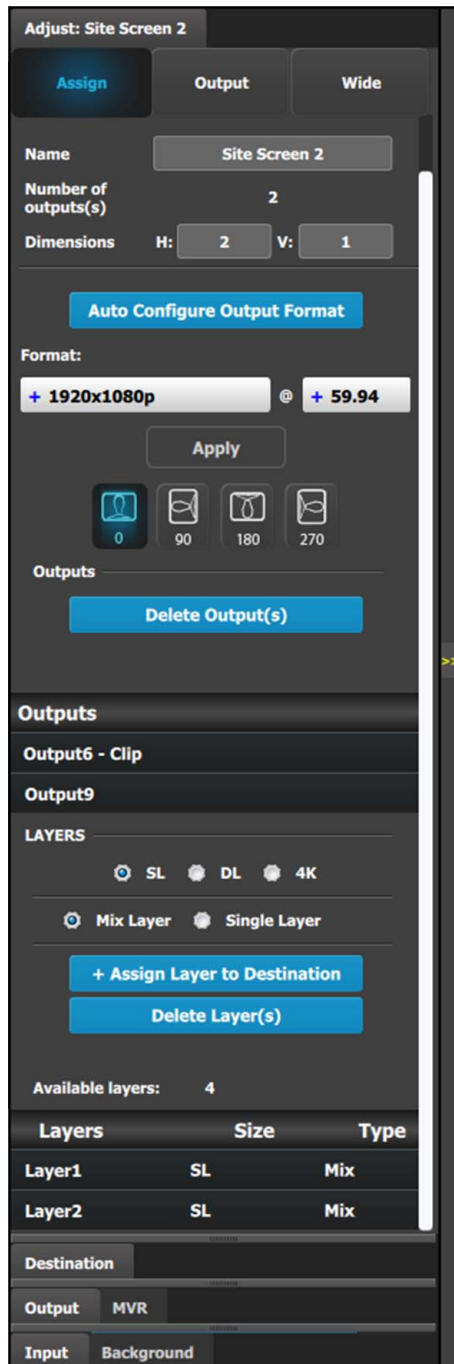

- Name: Adjusts the name of the Destination.
 - Destination type: Reports the type of destination Screen or Aux. Can convert from Screen to Aux if it meets requirements.
 - Number of output(s): Reports the number of output configurations in the destination.
 - Dimension: Adjust the output configuration layout .
 - Auto configure Output format: Reads the EDID information of the connected device to acquire its format. If more than one device is connected to the destination, it reads the format of the first output. This feature is not available for SDI outputs.
 - Output(s) format: Adjusts the output format of the destination. This is applied to all outputs that are added into this destination.
If you cannot find the output format in the list, it is possible that the connector capacity for the connector is too small. Remove the outputs from the Destination; update the connector capacity; and check again. (Refer to "Configuration Menu > Adjustment > Output Configuration", page 130, and see the subsections "How to delete Output" and "Output adjustment panel > Connector Menu.")
 - Output rotation icons: Adjust the counterclockwise rotation of the Output of a Screen or an AUX Destination. The rotation can be 0°, 90°, 180°, or 270°. The default rotation is 0°.
 - When a Destination is rotated, the Output AOI setting is reset to full, and new min and max values are applied. For example, when an AOI with a rotation of 0° is 1920x1080, then that same AOI with 90° rotation is 1080x1920.
 - When a Destination is rotated, the Destination cannot be in minimum delay.
Rotation adds an extra frame of delay;
 - o Minimum delay capable Screen Destinations that are rotated have 1 frame of delay.
 - o Non-minimum delay capable Screen Destinations that are rotated have 2 frames of delay.
 - o AUX Destinations have 1 frame of delay.
 - o Rotated AUX Destinations have 2 frames of delay.
 - When a Destination is rotated, the canvas is accordingly resized.
 - When a Destination is rotated, the Screen Destination as a source to a Layer is not rotated.
- Note:** The Output rotation icons are available only for Output from the Quad DisplayPort 1.2 Output card and from the Tri-Combo Output card.
- Outputs: Provides a list of the output configurations assigned to the Destination.
For Aux destinations, only 1 Output configuration is shown or is allowed to be defined. From this menu outputs can be deleted or added as in the output configuration menu.
 - Layer (only applicable when Destination is a Screen). You can assign a size to the Layer: SL (2K Single Link), DL (Dual Link), or 4K. You can also make the Layer either a Mixing Layer or a Single Layer.
The list shows the Layers assigned to this Destination.

A word about layers

Adding to the general description above about layers, more specifically an EMP's Screen Destination has 1 fixed Mixing layer, its BG. Then there are a number of mixing layers available in the system.

The E2 has 2 Banks of 8 Mixing Layers for a total of 16 Mixing Layers or 32 Single Layers (32L). These 16 Mixing Layers can be assigned to Destinations, using up to 4 Outputs (1 Bank). If a Destination uses Outputs from both Banks, the Mixing Layer count is reduced to 8. An E2 Jr. has a single Bank of 8 Mixing Layers for a total of 8 Mixing Layers or 16 Single Layers (16L).

6. EM GUI orientation

An S3-4k has 1 bank of 4 Mixing Layers for a total of 4 Mixing Layers or 8 Single Layers (8L). These 8 Mixing Layers can be assigned to Destinations, using up to 4 Outputs (1 Bank). An S3-4k Jr. has a single Bank of 2 Mixing Layers for a total of 2 Mixing Layers or 4 Single Layers (4L).

Processor	Banks	Mixing Layers	Single Layers
E2	2	16	32
E2 Jr.	1	8	16
S3-4K	1	4	8
S3-4K Jr.	1	2	4
EX	NA	NA	NA

The layer system has been optimized in E2 to allow the maximum available layer count at all times and can therefore be a bit confusing.

Based on the Layer mode (set in the System Modifier Panel), the number of "Assign Layer to Destination" varies. The table below shows the maximum number of single layers for each layer mode.

Mixing Layer Type	Maximum number of Single Layers				
	E2	E2 Jr.	S3-4K	S3-4K Jr.	EX
2K HD	32	16	8	4	NA
Dual Link	16	8	4	2	NA
4K	8	4	2	1	NA



Layers need to be assigned to destinations before sources can be added to the destination.

Output menu

The Output Menu contains four sub-menus: **Main**, **Color**, **Timing** and **Connector** properties. Adjustments to the **Main**, **Timing**, and **Connector** properties are identical with the adjustments to the **Main**, **Timing**, and **Connector** properties in the output configuration menu. In this destination configuration menu, however, adjustments can be performed on all or on selected outputs that make up the destination. Individual outputs can be selected by clicking on the corresponding screen. When a screen is selected its outline turns blue. All outputs can also be selected by clicking on the **Select All** button.

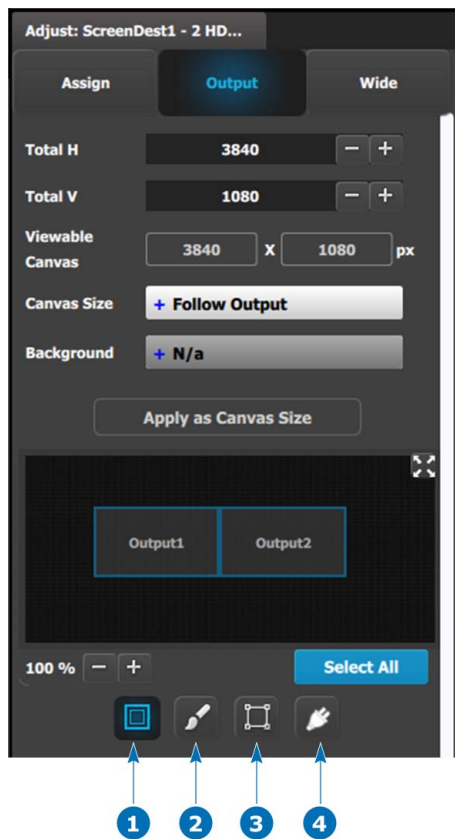
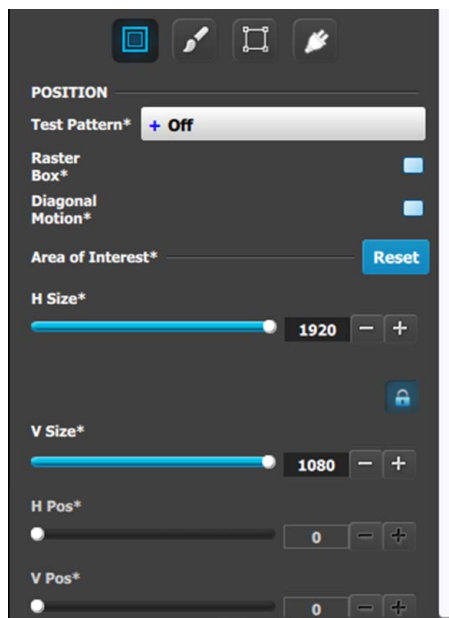

Image 6-31
Configuration Menu: Destination Adjust—Output (Top of panel)

- 1 Main
- 2 Color
- 3 Timing
- 4 Connector properties

Output menu – Main submenu



Operate similarly to the Output adjustment panel > Main menu.

- **Test pattern:** Turns the Test Patterns ON and select the desired type. The default setting is OFF. Test pattern types:

– Horizontal Ramp	– Horizontal steps
– Vertical Ramp	– Vertical steps
– 100% Color Bars	– White
– 16x16 Grid	– Black
– 32x32 Grid	– SMPTE Bars
– Burst	– H Alignment
– 75% Color Bars	– V Alignment
– 50% Gray	– H V Alignment
	– Circle Alignment
- **Raster box:** Turns ON or OFF on a raster around the default active area. This raster box is a white, single-pixel-wide broken line.
- **Diagonal Motion:** Turns the Diagonal Motion ON or OFF for select patterns:
 - The motion is a bottom-right to top-left diagonal for 16x16, 32x32 grid.
 - The motion is right to left for 100% Color Bars.
 - There is no motion in Horizontal and vertical Ramps and other patterns.

- Area of Interest (AOI):** A raster box that can be positioned and sized within the outputs active area, it effectively makes the AOI the new active area. This raster box is a green, single-pixel-wide broken line that helps you adjust the AOI within the output's active area. The handles for the AOI menu are:
 - H Size and V size: Adjusts the horizontal and vertical positions respectively.
 - H Pos and V pos: Adjusts the horizontal and vertical positions respectively.
 - Note a lock button allows user to lock the aspect ratio of the size.
- Reset button:** resets the AOI to default which is the full output area.

Operate similar as the Output adjustment panel > Main page. See above.

Output menu – Color submenu

The Output Effects Submenu adjusts color variable of the output image, such as contrast and brightness, saturation, hue and gamma corrections.

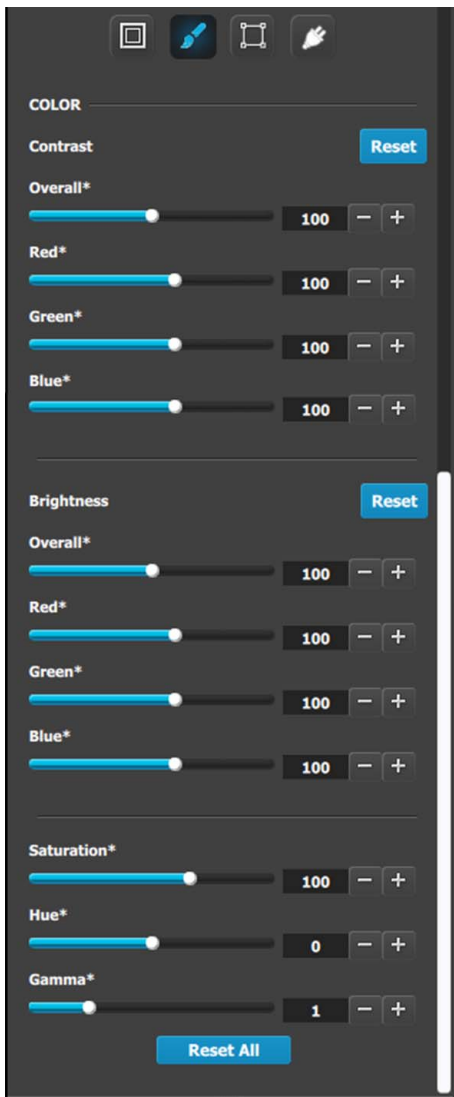

- The RGB Contrast and Brightness settings are adjustable.
 - The Overall adjustment has a range of 50 to 150.
 - The individual Red/Green/Blue adjustments have a range of 25 to 150.
 - The default setting for all of these properties is 100.
- Saturation is adjustable within a range of 0 to 150. The default setting is 100.
- Hue is adjustable within a range of -90 to +90 degrees. The default setting is 0 degrees.
- Gamma is adjustable within a range of 0.31 to 3.29. The default setting is 1.0.
- Reset All changes all values to their default settings.

Output menu – Timing submenu

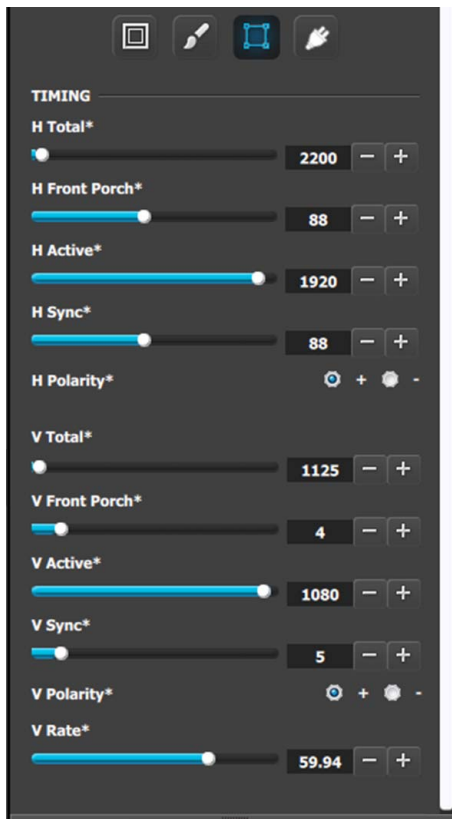

Operate similarly to the Output adjustment panel > Timing menu.

- **Format:** Selects the video format of the output configuration from the drop menu. This is the same adjustment as in the previous menu.
- **H Total:** Adjusts (in pixels) the total pixel count per line for the selected output.
- **H Front Porch:** Adjusts (in pixels) the offset between the end of the output active area and the beginning of H sync.
- **H Active:** Adjusts (in pixels) the horizontal size of the output active area.
- **H Sync:** Adjusts (in pixels) the H sync width.
- **H Polarity:** Adjusts the polarity (active High or Low) of the horizontal sync pulse (N/A in SDI).
- **V Total:** Adjusts (in lines) the total line count per frame.
- **V Front Porch:** Adjusts (in lines) the offset between the end of the output active area and the beginning of V sync.
- **V Active:** Adjusts (in lines) the vertical size of the output active area.
- **V Sync:** Adjusts (in lines) the V sync width.
- **V Polarity:** Adjusts the polarity (active High or Low) of the vertical sync pulse (N/A in SDI).
- **V Rate:** Adjusts the frame rate in seconds polarity (active High or Low) of the vertical sync pulse (N/A in SDI).

Note: Changing these values can make the video signal undetectable for other devices. Always use a VESA timing calculator for best results.

Output menu – Connector submenu

Operate similarly to the Output adjustment panel > Connector menus.

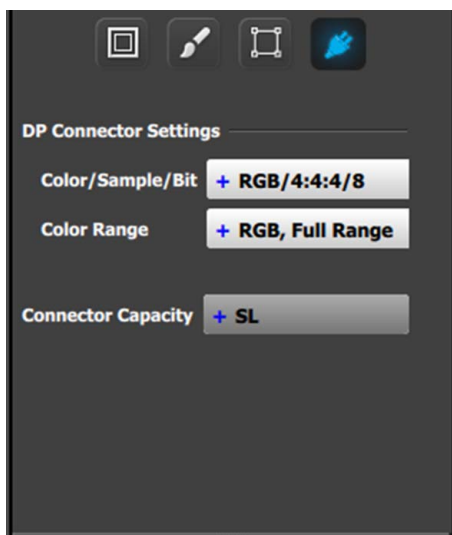

DisplayPort Connector submenu

- **Color/Sample/Bit:** Adjusts the color space (RGB or YCbCr), sampling rate (4:4:4) and bit depth (8, 10, or 12) of the output signal.
- **Color Range:** Adjusts the color range (RGB or SMPTE, Full or Reduced).
- **Connector Capacity:** If the connector is not assigned to a destination as above the capacity can be changed. Once included in a Destination configuration this needs to be managed thru the Adjust pane of the Destination.

DisplayPort Connector submenu

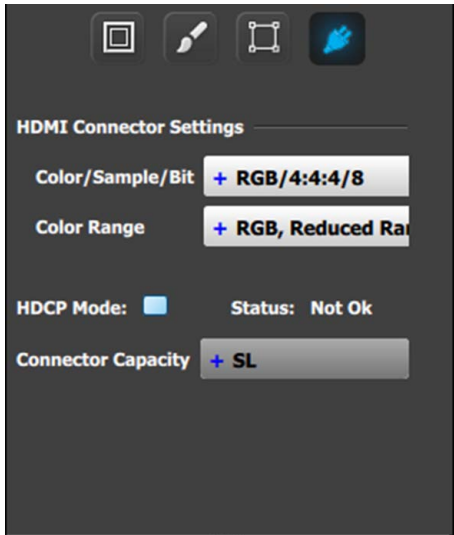

HDMI Connector submenu

HDMI Connector submenu

- **Color/Sample/Bit:** Choices are:
 - RGB/4:4:4/8
 - RGB/4:4:4/10
 - RGB/4:4:4/12
 - YCbCr/4:4:4/8
 - YCbCr/4:4:4/10
 - YCbCr/4:4:4/12
 - YCbCr/4:2:2/12
- **Color Range:** Choices are:
 - RGB, Reduced Range (Values 16–235, television and movies)
 - RGB, Full Range (Values 0–255, computer monitors)
 - SMPTE, Full Range
 - SMPTE, Reduced Range
- **HDCP Mode:** HDCP Mode enables the HDCP setting for the selected output. The default for HDMI outputs is Off. To turn On the HDCP Mode, click on the empty checkbox. When the checkbox displays a check mark, HDCP Mode is On. HDCP Mode is not applicable to SDI outputs.
- **Connector Capacity:** If the connector is not assigned to a destination as above the capacity can be changed. Once included in a Destination configuration this needs to be managed thru the Adjust pane of the Destination.

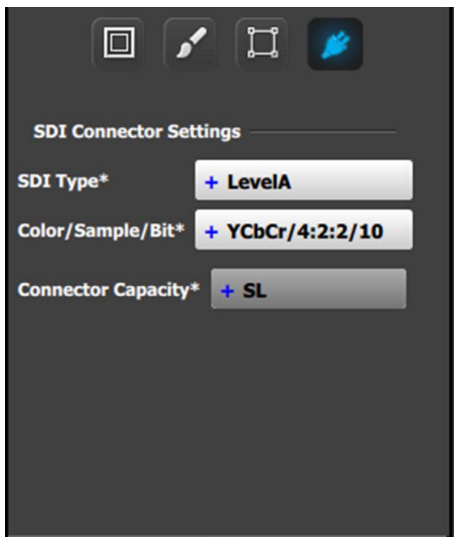

SDI Connector submenu

SDI Connector submenu

- **SDI Type** (available with SDI connector type): allows a choice between HD (1.5Gb), 3G (3Gb), Level A, Level B, Level A 2SI, or Level B 2SI. The SDI Type options vary, depending on the format of the Outputs. For example, for:
 - NTSC/PAL—the SDI Type can be only SD.
 - 1080i or 1080p, with a refresh rate less than or equal to 30 Hz—the SDI Type can be only HD.
 - 1080p, with a refresh rate greater than 30 Hz—the SDI Type can be:
 - o Level A (default)
 - o Level B
 - o Level A 2SI
 - o Level B 2SI
 The 2SI options are available only if the Input/Output configuration has 4 SDI connectors from the same card, and the Output format is either 1920 x 1080 or 2048 x 1080.
- **Color/Sample/Bit:** Adjusts the color space (YCbCr), sampling rate (4:2:2) and bit depth (10) of the output signal.
- **Connector Capacity:** If the connector is not assigned to a destination as above the capacity can be changed. Once included in a Destination configuration this needs to be managed thru the Adjust pane of the Destination.

Wide (screen) menu

In this menu, the user can adjust the data-doubling and feathering parameters necessary to setup a wide blended screen. These actions can be performed simultaneously on all screens by clicking the “Select All” button. The data-doubling parameters can be adjusted in either Basic Mode or Expert Mode.

Data-doubling submenu—Basic Mode

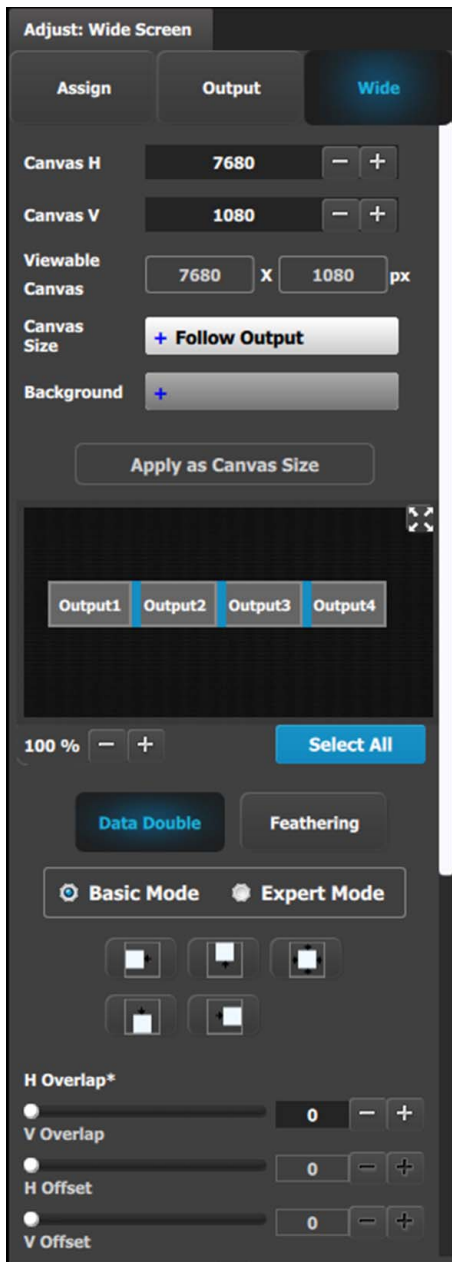

- **Canvas H:** This is the horizontal size of the canvas, measured in pixels. The edit box allows the user to adjust this size.
- **Canvas V:** This is the vertical size of the canvas, measured in pixels. The edit box allows the user to adjust this size.
- **Viewable Canvas:** Viewable Canvas displays the horizontal and vertical size of the viewable canvas in pixels. This is the area that the Outputs cover in the canvas.
- **Canvas Size:** The options are “Follow Output” and “Use Background.”
 - “Follow Output” matches the canvas size to H/V Dimension edit boxes in the Assign tab and the Output Config format.
 - “Use Background,” matches the canvas size to that of a selected Background.
- **Background:** If the Canvas Size is set to “Use Background,” this drop-down box lets the user select from the available backgrounds.
- **Apply as Canvas Size:** When switching between “Follow Output” and “Use Background,” the user must click on this button to choose the new canvas size.
- **Data Doubling H or V Overlap width:** The adjustment can be made by moving the slider, entering the value manually in the box, or clicking on the plus and minus.

Note: The Overlap sliders are disabled, until at least one overlapping area is selected. Gray overlaps are unselected; blue overlaps are selected. Individual overlaps can be selected by clicking on the desired overlap in the output image. All overlaps can be selected by clicking on the **Select All** button.
- Once an overlap is created, H and V offset can be adjusted for Left, Right, or Center justification over the Background.
- The icons above the sliders are shortcuts for the offset.

Data-doubling submenu—Expert Mode

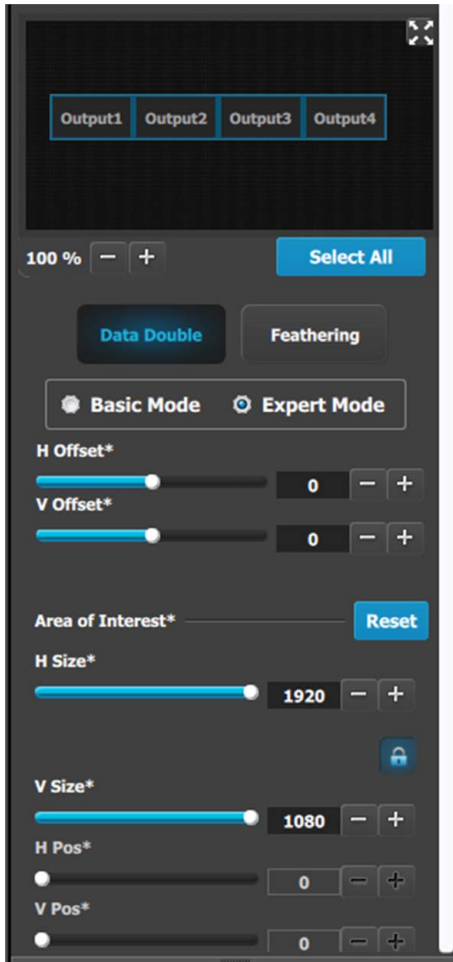

The top part of the panel is the same in Expert Mode as it is in Basic Mode. Expert Mode, however, offers greater control over horizontal and vertical Offset and Size. Expert Mode also allows the user to add Outputs without increasing the canvas size and to place those Outputs anywhere within the canvas.

- **Data Doubling H or V Overlap width:** The adjustment can be made by moving the slider, entering the value manually in the box, or clicking on the plus and minus.
Note: The Overlap sliders are disabled, until at least one overlapping area is selected. Gray overlaps are unselected; blue overlaps are selected. Individual overlaps can be selected by clicking on the desired overlap in the output image. All overlaps can be selected by clicking on the **Select All** button.
- Once an overlap is created, H and V offset can be adjusted for Left, Right, or Center justification over the Background.
- The Area of Interest (including H Size and V Size) is duplicated here from the Output tab, so that the user can adjust the AOI and the X/Y Offset together.
- The icons above the sliders are shortcuts for the offset.

Feathering submenu

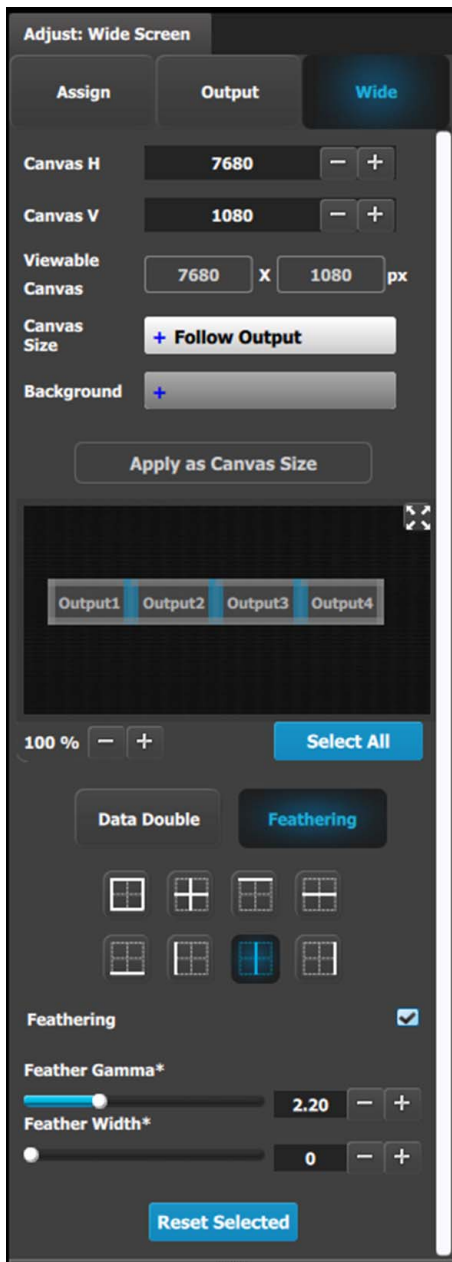

- Canvas shows the actual pixel ratio for the full blend.
- Select the region where feathering will be performed. All edges can be separately selected and have a different value of Feather and Gamma. The adjustment can be made by moving the slider, entering the value manually in the box or click on the plus and minus.
Note: The Feathering and Gamma sliders are disabled, until at least one edge that can be feathered is selected. Gray edges are unselected; blue edges are selected.
- Activate or deactivate the feather for the selected edge by checking the Feathering checkbox.
- Adjust the Feathering Gamma (shape of the curve) and the width of the feathering region.
- The icons above are shortcuts for edge selection.
- The Arrow icon allows the small windows representation of the blend to be copied to the workspace for ease of edge selection.

6.17 Configuration Menu > Linking

General

This part of the System configuration page lists devices available on the local network and allows adding them to a Linked System Set up.

The Link cards allow for linking multiple Event Master units. Depending on the linking configuration, linked units share inputs, and they expand the number of layers and outputs. For example, with code release 1.5, 2 E2 units can be linked.

Just as in section "Configuration Menu > Network resource area", page 108, the unit that is supposed to be added is available in the network resource tab. Any second unit can be added, it only needs to have a separate Unit ID. Change the Unit ID of each system to be different. The default Unit ID is 0 on all Event Master presentation switchers—E2, S3-4K, and EX. On one of the E2s change the Unit ID to 1 from the front panel, or by temporarily adding them as separate systems.

A second E2 or S3-4K unit adds fully double capacity from one unit. There are very few limitations to the capacity and operation is all in all the same as for one unit.



After linking chassis, a few menus provide the option of changing between which unit controls you are viewing.

From the Menu bar at the top of all pages, you can select which processor's details you are viewing, by selecting that processor from the pull down menu.



There is no relationship between Unit ID and Master or Slave selection. Either unit can be Master or Slave in a linked configuration. The only real significance—but totally transparent to users—is the Event Master Toolset communicates only with the Master unit. The Master unit establishes its own connection and handles all communications with the Slave.



Certain configuration setups are not allowed. These include spanning input or output configurations between an E2 and an S3-4K. If your setup requires this kind of configuration, then you must link together two E2 units or two S3-4K units.

How to Link Two E2 Units

Each E2 comes equipped with two Link cards, always located in slots 1 and 2. Link cards are identified by a yellow stripe at the top. Make sure to use the locking mechanism and then push each cable until it locks in place.

Connect the Link cables provided with each E2 between the Link connectors as follows:

- VP ID 0, Link Card slot 1, Link 1 >> VP ID 1, Link Card slot 1, Link 2 [1]
- VP ID 0, Link Card slot 1, Link 2 >> VP ID 1, Link Card slot 1, Link 1 [2]
- VP ID 0, Link Card slot 2, Link 1 >> VP ID 1, Link Card slot 2, Link 2 [3]
- VP ID 0, Link Card slot 2, Link 2 >> VP ID 1, Link Card slot 2, Link 1 [4]

See image 6-32 for an example of the cabling between two E2 units.

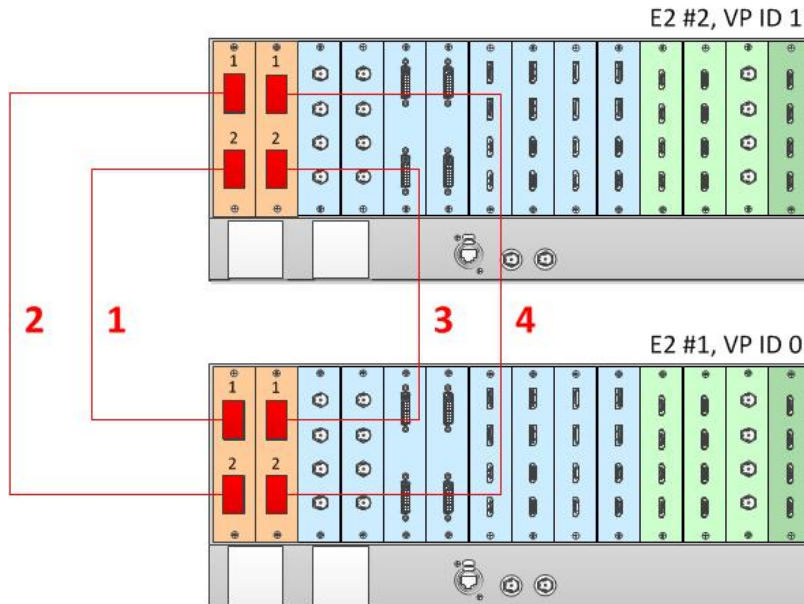

Image 6-32
Cabling between two E2 units

Event Master Configuration for Two E2s

1. Start the Event Master Toolset version 1.5 or higher.
2. Make sure that the two E2s are discovered on the network and that they have different Unit IDs.
3. Drop one of the two E2s in the GUI.
4. Then drop the second E2.

You will be presented the option to add as a new system, add as a master, or add as a slave.

5. Select either add as a master or add as a slave.
6. (Optional) At this point it is suggested that you select and name appropriately each E2 so that you can identify it in your setup.

How to Link Three E2 Units

Each E2 comes equipped with two Link cards, always located in slots 1 and 2. Link cards are identified by a yellow stripe at the top. Make sure to use the locking mechanism and then push each cable until it locks in place.

Connect the Link cables provided with each E2 between the Link connectors as follows:

- VP ID 0, Link Card slot 1, Link 1 >> VP ID 2, Link Card slot 1, Link 2 [1]
- VP ID 0, Link Card slot 2, Link 1 >> VP ID 2, Link Card slot 2, Link 2 [2]
- VP ID 0, Link Card slot 1, Link 2 >> VP ID 1, Link Card slot 1, Link 1 [3]
- VP ID 0, Link Card slot 2, Link 2 >> VP ID 1, Link Card slot 2, Link 1 [4]
- VP ID 1, Link Card slot 1, Link 2 >> VP ID 2, Link Card slot 1, Link 1 [5]
- VP ID 1, Link Card slot 2, Link 2 >> VP ID 2, Link Card slot 2, Link 1 [6]

See image 6-33 for an example of the cabling between three E2 units.

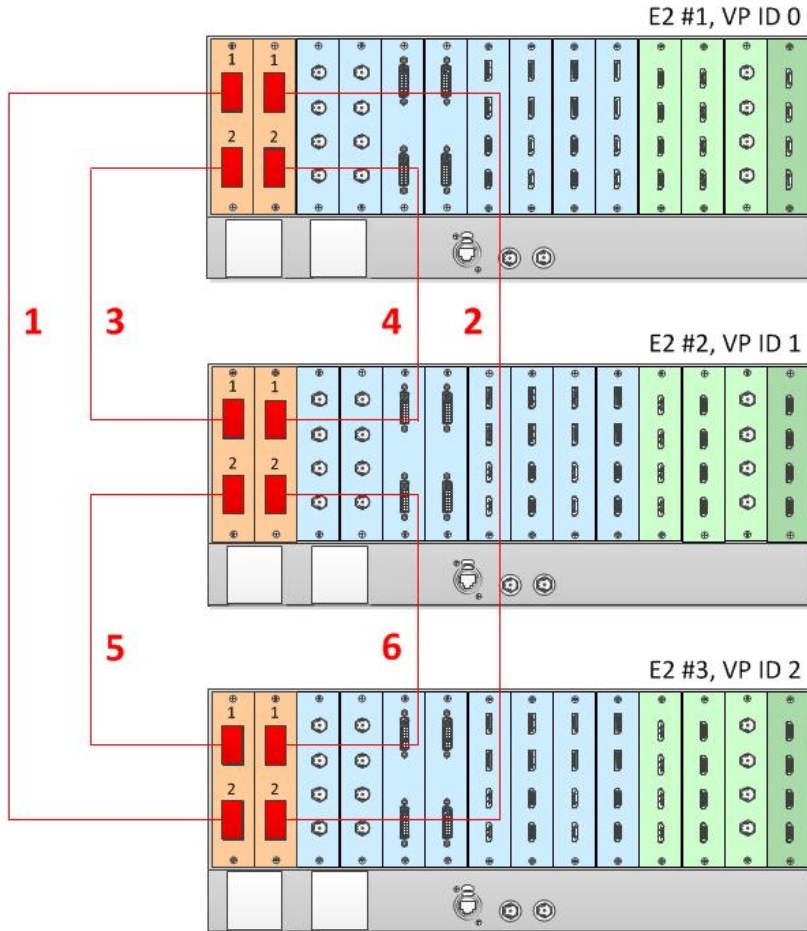

Image 6-33
Cabling between three E2 units

Event Master Configuration for Three E2s

1. Start the Event Master Toolset version 5.1 or higher.
2. Make sure that the three E2s are discovered on the network and that they have different Unit IDs.
3. Drop one of the E2s in the GUI.
4. Drop the second E2.
You will be presented the option to add as a new system, add as a master, or add as a slave.
5. Select either add as a master or add as a slave.
6. Drop the third E2.
You will be presented the option to add as a new system, add as a master, or add as a slave.
7. Select either add as a master or add as a slave.
8. (Optional) At this point it is suggested that you select and name appropriately each E2 so that you can identify it in your setup.

How to Link an E2 Unit to an EX Unit or to Two Daisy-Chained EX Units

Each E2 comes equipped with two Link cards, always located in slots 1 and 2. Link cards are identified by a yellow stripe at the top. Each EX has two Link sockets. Make sure to use the locking mechanism and then push each cable until it locks in place.

To link an E2 to an EX, connect the Link cables provided with each unit between the Link connectors as follows:

- E2 VP ID 0, Link Card slot 1, Link 1 >> EX VP ID 1, Link 2
- EX VP ID 1, Link 1 >> EX VP ID 2, Link 2

See image 6-34 for an example of the cabling between an E2 unit and two EX units.

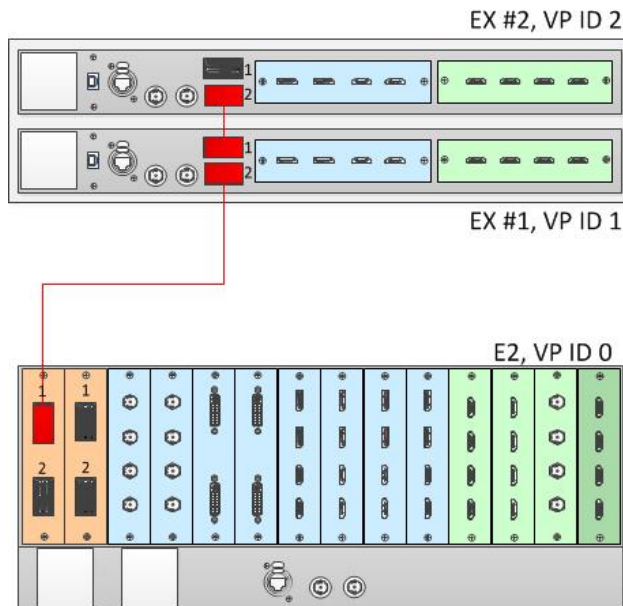

Image 6-34
Cabling between an E2 unit and two daisy-chained EX units

Event Master Configuration for an E2 and an EX

1. Start the Event Master Toolset version 4.0 or higher.
2. Make sure that both the E2 and the EX are discovered on the network and that they have different Unit IDs.
3. Drop the E2 in the GUI.
If the E2 unit is cabled to an EX unit or a pair of daisy-chained EX units, the EX unit appears as a grayed-out box below the E2 unit in the Diagram area. In the grayed-out EX box a blue button allows you to add the EX to the system as a slave.
4. Click the blue add button to add the EX unit.
If you are adding two daisy-chained EX units, you must add the first EX in the chain before the second EX in the chain is displayed, then repeat step 4 to add the second EX in the chain.
5. (Optional) At this point it is suggested that you select and name appropriately each unit so that you can identify it in your setup.



Each of the four Links on an E2 can be connected to two daisy-chained EX units.



An S3-4K can be linked to two daisy-chained EX units. The procedure is the same as the procedure for linking an E2 to two daisy-chained EX units.



A daisy chain of two EX units cannot have more than two input cards or more than two output cards. Each EX in the chain can have both input cards, both output cards, or an input card and an output card.

How to Link an E2 Unit to an EX Unit with Two VPU Cards

To add up to eight Single or four Mixing Layers to a system, an E2 unit can be linked to an EX unit with two VPU cards. This adds two VPUs. Each E2 comes equipped with two Link cards, always located in slots 1 and 2. Link cards are identified by a yellow stripe at the top. Each EX has two Link sockets. Make sure to use the locking mechanism and then push each cable until it locks in place.

To link an E2 to an EX, connect the Link cables provided with each unit between the Link connectors as follows:

- E2 VP ID 0, Link Card slot 1, Link 1 >> EX VP ID 1, Link 2 [1]
- E2 VP ID 0, Link Card slot 1, Link 2 >> EX VP ID 1, Link 1 [2]

See image 6-35 for an example of the cabling between an E2 unit and an EX unit with two VPU cards.

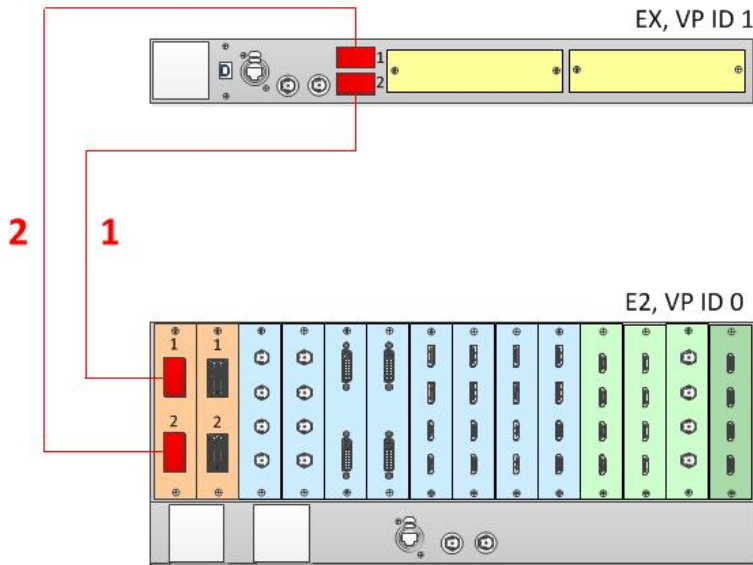

Image 6-35
Cabling between an E2 unit and an EX unit with two VPU cards

How to Link an E2 Unit to an EX Unit with a Mixed I/O/VPU Configuration

To add up to four Single Layers or two Mixing Layers to a system, an E2 unit can be linked to an EX unit with a single VPU card. This adds a single VPU. The VPU can be in either slot 1 or slot 2 on the EX unit, and the other slot may contain either an Event Master Input card or an Event Master Output card. Each E2 comes equipped with two Link cards, always located in slots 1 and 2. Link cards are identified by a yellow stripe at the top. Each EX has two Link sockets. Make sure to use the locking mechanism and then push each cable until it locks in place.

To link an E2 to an EX, connect the Link cables provided with each unit between the Link connectors as follows:

- E2 VP ID 0, Link Card slot 1, Link 1 >> EX VP ID 1, Link 2 [1]
- E2 VP ID 0, Link Card slot 1, Link 2 >> EX VP ID 1, Link 1 [2]

See image 6-36 for an example of the cabling between an E2 unit and an EX unit with a VPU card and either an Event Master Input card or an Event Master Output card.

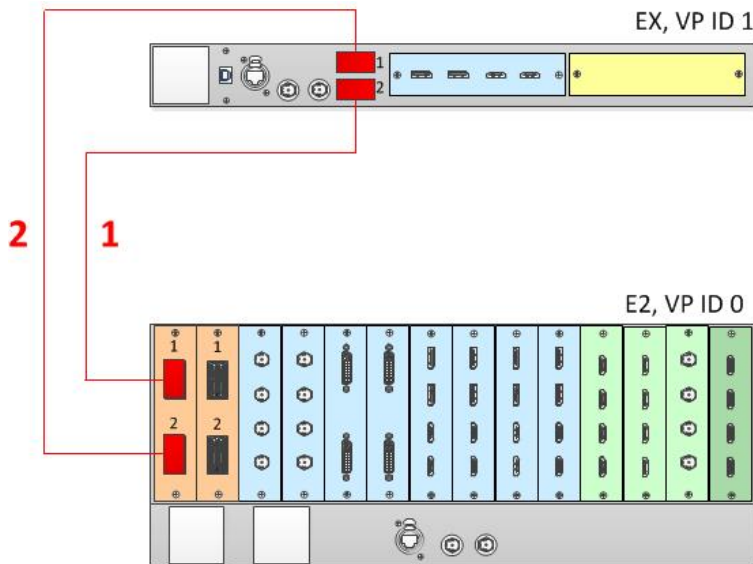

Image 6-36
Cabling between an E2 unit and an EX unit with a VPU card



When an EX unit has VPU cards rather than a combination of Input and Output cards, and it is connected to an E2 processor or to an S3-4K processor, the EX unit can no longer be daisy-chained to another EX unit; both Link connectors on the EX unit must be connected to the E2 or S3-4K Master unit.

Event Master Configuration for Linking an E2 Unit to an EX Unit with VPU Cards

1. Start the Event Master Toolset version 5.1 or higher.

2. Make sure that both the E2 and the EX are discovered on the network and that they have different Unit IDs.
3. Drop the E2 in the GUI.
If the E2 unit is cabled to an EX unit, the EX unit appears as a grayed-out box below the E2 unit in the Diagram area. In the grayed-out EX box a blue button allows you to add the EX to the system as a slave.
4. Click the blue add button to add the EX unit.
5. (Optional) At this point it is suggested that you select and name appropriately each unit so that you can identify it in your setup.

How to Link an E2 Unit to Two EX Units, Each with Two VPU Cards

To add up to 16 Single or eight Mixing Layers to a system, an E2 unit can be linked to two EX units, each with two VPU cards. This adds a total of four VPUs. Each E2 comes equipped with two Link cards, always located in slots 1 and 2. Link cards are identified by a yellow stripe at the top. Each EX has two Link sockets. Make sure to use the locking mechanism and then push each cable until it locks in place.

To link an E2 to two EX units, connect the Link cables provided with each unit between the Link connectors as follows:

- E2 VP ID 0, Link Card slot 1, Link 1 >> EX VP ID 1, Link 2 [1]
- E2 VP ID 0, Link Card slot 1, Link 2 >> EX VP ID 1, Link 1 [2]
- E2 VP ID 0, Link Card slot 2, Link 1 >> EX VP ID 2, Link 2 [3]
- E2 VP ID 0, Link Card slot 2, Link 2 >> EX VP ID 2, Link 1 [4]

See image 6-37 for an example of the cabling between an E2 unit and an EX unit with two VPU cards.

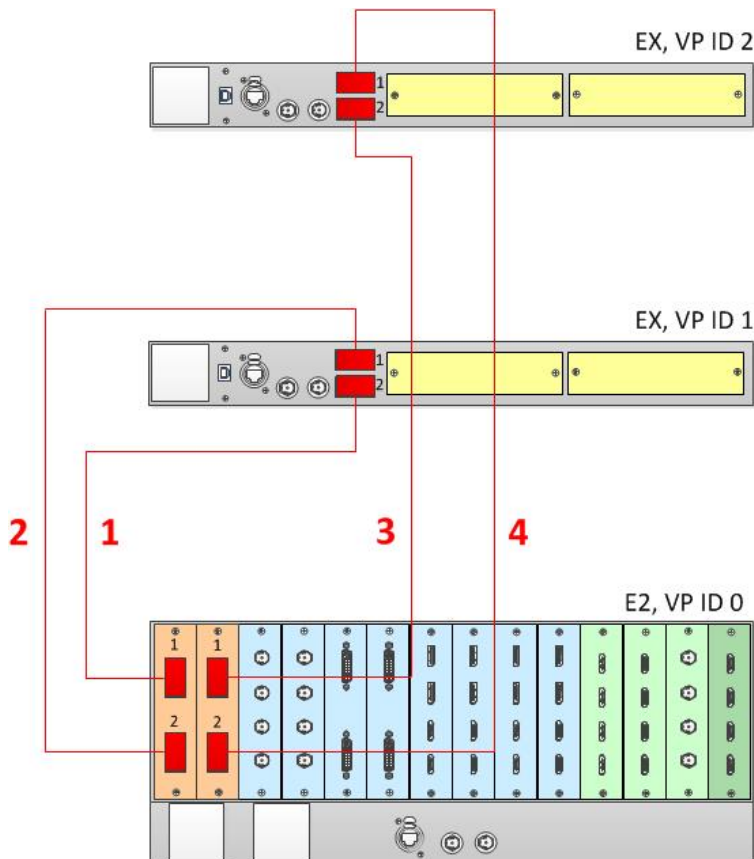

Image 6-37
Cabling between an E2 unit and two EX units



When an EX unit has VPU cards rather than a combination of Input and Output cards, and it is connected to an E2 processor or to an S3-4K processor, the EX unit can no longer be daisy-chained to another EX unit; both Link connectors on the EX unit must be connected to the E2 or S3-4K Master unit.

How to Link an E2 Unit to Two EX Units, Each with a Mixed I/O/VPU Configuration

To add up to eight Single Layers or four Mixing Layers to a system, an E2 unit can be linked to two EX units, each with a single VPU card. This adds two VPUs. The VPU can be in either slot 1 or slot 2 on the EX unit, and the other slot may contain either an Event Master Input card or an Event Master Output card. Each E2 comes equipped with two Link cards, always located in slots 1 and 2. Link cards are identified by a yellow stripe at the top. Each EX has two Link sockets. Make sure to use the locking mechanism and then push each cable until it locks in place.

To link an E2 to two EX units, connect the Link cables provided with each unit between the Link connectors as follows:

- E2 VP ID 0, Link Card slot 1, Link 1 >> EX VP ID 1, Link 2 [1]
- E2 VP ID 0, Link Card slot 1, Link 2 >> EX VP ID 1, Link 1 [2]
- E2 VP ID 0, Link Card slot 2, Link 1 >> EX VP ID 2, Link 2 [3]
- E2 VP ID 0, Link Card slot 2, Link 2 >> EX VP ID 2, Link 1 [4]

See image 6-38 for an example of the cabling between an E2 unit and an EX unit with a VPU card and either an Event Master Input card or an Event Master Output card.

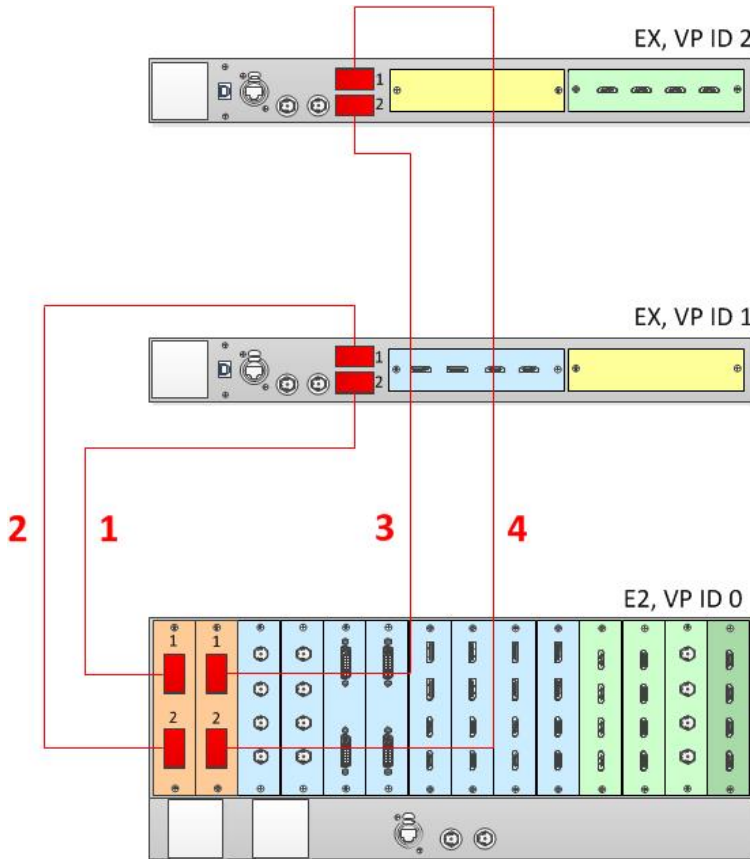

Image 6-38
Cabling between an E2 unit and two EX units, each with a VPU card



When an EX unit has VPU cards rather than a combination of Input and Output cards, and it is connected to an E2 processor or to an S3-4K processor, the EX unit can no longer be daisy-chained to another EX unit; both Link connectors on the EX unit must be connected to the E2 or S3-4K Master unit.

Event Master Configuration for Linking an E2 Unit to Two EX Units with VPU Cards

1. Start the Event Master Toolset version 5.1 or higher.
2. Make sure that both the E2 and the EX are discovered on the network and that they have different Unit IDs.
3. Drop the E2 in the GUI.
If the E2 unit is cabled to an EX unit, the EX unit appears as a grayed-out box below the E2 unit in the Diagram area. In the grayed-out EX box a blue button allows you to add the EX to the system as a slave.
4. Click the blue add button to add the EX unit.
5. (Optional) At this point it is suggested that you select and name appropriately each unit so that you can identify it in your setup.

How to Link an E2 Unit and an S3-4K Unit

Each E2 comes equipped with two Link cards, always located in slots 1 and 2. Each S3-4K has a single Link card in slot 1. Link cards are identified by a yellow stripe at the top. Make sure to use the locking mechanism and then push each cable until it locks in place.

Connect the Link cables provided with each unit between the Link connectors as follows:

- E2 VP ID 0, Link Card slot 1, Link 1 >> S3-4K VP ID 1, Link Card slot 1, Link 2 [1]
- E2 VP ID 0, Link Card slot 1, Link 2 >> S3-4K VP ID 1, Link Card slot 1, Link 1 [2]

See image 6-39 for an example of the cabling between an E2 unit and an S3-4K unit.

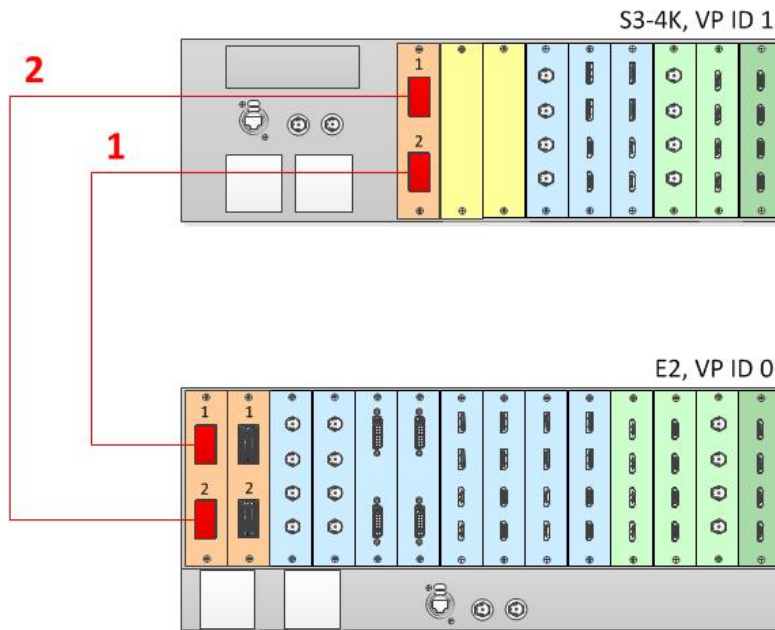

Image 6-39
Cabling between an E2 unit and an S3-4K unit

Event Master Configuration for Linking an E2 and an S3-4K

1. Start the Event Master Toolset version 3.2 or higher.
2. Make sure that both the E2 and the S3-4K are discovered on the network and that they have different Unit IDs.
3. Drop the E2 in the GUI.
4. Then drop the S3-4K in the GUI.
You will be presented the option to add as a new system, add as a master, or add as a slave. An S3-4K can be added as a Master or Slave to an E2.
5. Select either add as a master or add as a slave.
6. (Optional) At this point it is suggested that you select and name appropriately each unit so that you can identify it in your setup.

How to Link an E2 Unit and two S3-4K Units

Each E2 comes equipped with two Link cards, always located in slots 1 and 2. Each S3-4K has a single Link card in slot 1. Link cards are identified by a yellow stripe at the top. Make sure to use the locking mechanism and then push each cable until it locks in place.

Connect the Link cables provided with each unit between the Link connectors as follows:

- E2 VP ID 0, Link Card slot 2, Link 1 >> S3 VP ID 1, Link Card slot 1, Link 2 [1]
- E2 VP ID 0, Link Card slot 2, Link 2 >> S3 VP ID 1, Link Card slot 1, Link 1 [2]
- E2 VP ID 0, Link Card slot 1, Link 1 >> S3 VP ID 2, Link Card slot 1, Link 2 [3]
- E2 VP ID 0, Link Card slot 1, Link 2 >> S3 VP ID 2, Link Card slot 1, Link 1 [4]

See image 6-40 for an example of the cabling between an E2 unit and two S3-4K units.

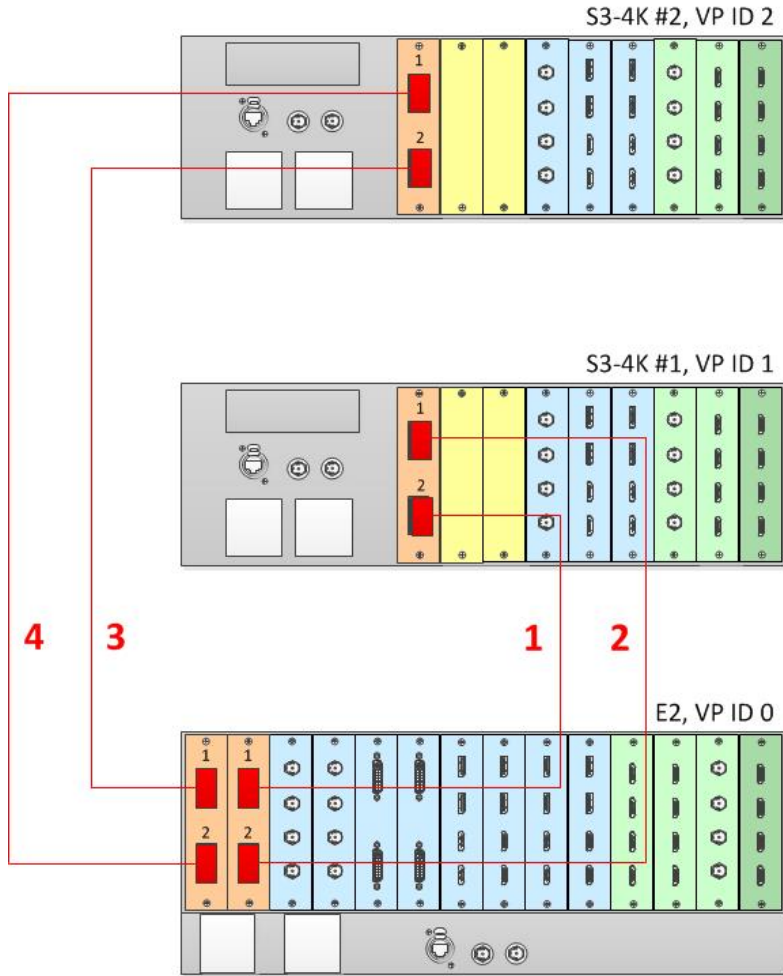

Image 6-40
Cabling between an E2 unit and two S3-4K units

Event Master Configuration for Linking an E2 Unit and Two S3-4Ks

1. Start the Event Master Toolset version 4.2 or higher.
2. Make sure that the E2 and the S3-4K units are discovered on the network and that they have different Unit IDs.
3. Drop the E2 in the GUI.
4. Drop the S3-4K #1 in the GUI.
You will be presented the option to add as a new system, add as a master, or add as a slave. An S3-4K can be added as a Master or Slave to an E2.
5. Select either add as a master or add as a slave.
6. Drop the S3-4K #2 in the GUI.
You will be presented the option to add as a new system, add as a master, or add as a slave. An S3-4K can be added as a Master or Slave to an E2.
7. Select either add as a master or add as a slave.
8. (Optional) At this point it is suggested that you select and name appropriately each unit so that you can identify it in your setup.

How to Link an E2 Unit, an S3-4K Unit, and four EX Units

Each E2 comes equipped with two Link cards, always located in slots 1 and 2. Each S3-4K has a single Link card in slot 1. Link cards are identified by a yellow stripe at the top. Each EX has two Link sockets. Make sure to use the locking mechanism and then push each cable until it locks in place.

Connect the Link cables provided with each unit between the Link connectors as follows:

- E2 VP ID 0, Link Card slot 1, Link 1 >> S3 VP ID 1, Link Card slot 1, Link 2 [1]
- E2 VP ID 0, Link Card slot 1, Link 2 >> S3 VP ID 1, Link Card slot 1, Link 1 [2]
- E2 VP ID 0, Link Card slot 2, Link 1 >> EX VP ID 2, Link 2 [3A]
- EX VP ID 2, Link 1 >> EX VP ID 3, Link 2 [3B]
- E2 VP ID 0, Link Card slot 2, Link 2 >> EX VP ID 4, Link 2 [4A]
- EX VP ID 4, Link 1 >> EX VP ID 5, Link 2 [4B]

See image 6-41 for an example of the cabling between an E2 unit, an S3-4K unit, and four EX units.

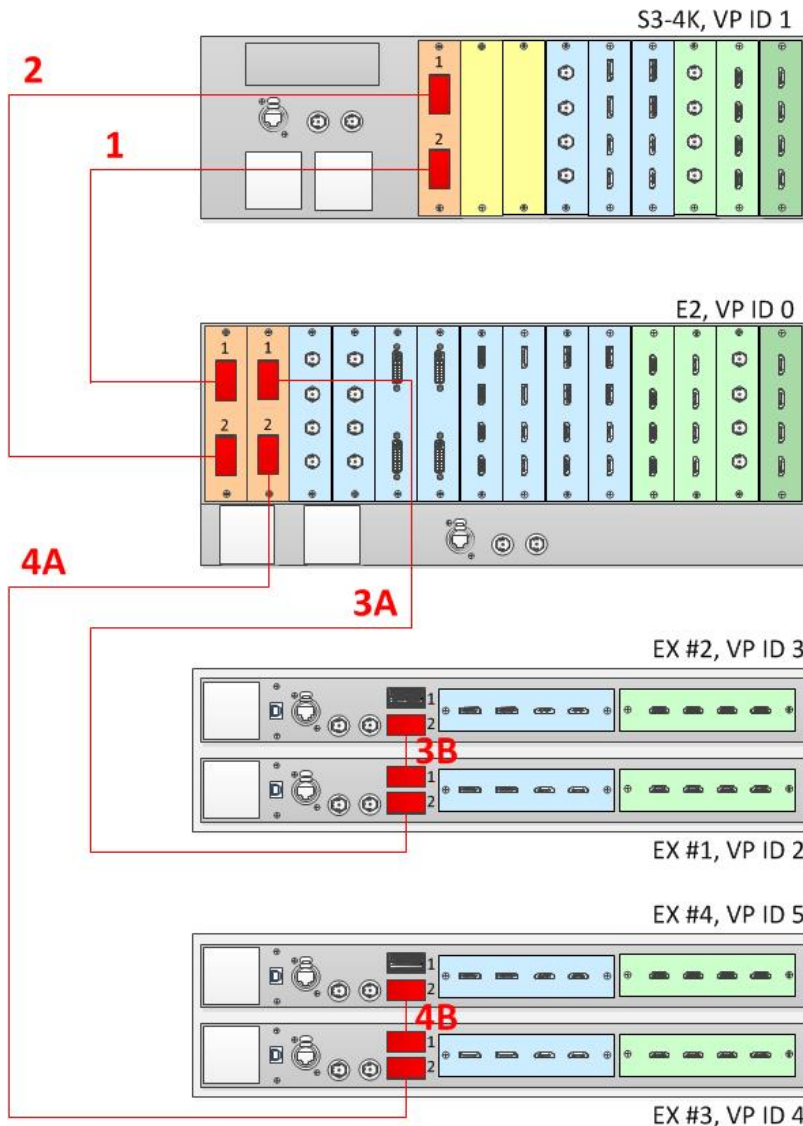

Image 6-41
Cabling between an E2 unit, an S3-4K unit, and four EX units

Event Master Configuration for Linking an E2, an S3-4K, and four EX Units

1. Start the Event Master Toolset version 4.1 or higher.
2. Make sure that the E2, the S3-4K, and the EX are discovered on the network and that they have different Unit IDs.
3. Drop the E2 in the GUI.
If the E2 unit is cabled to an EX unit or a pair of daisy-chained EX units, the EX unit appears as a grayed-out box below the E2 unit in the Diagram area. In the grayed-out EX box a blue button allows you to add the EX to the system as a slave.
4. Drop the S3-4K in the GUI.
You will be presented the option to add as a new system, add as a master, or add as a slave. An S3-4K can be added as a Master or Slave to an E2.
5. Add the S3-4K as a slave.
6. (Optional) At this point it is suggested that you select and name appropriately each unit so that you can identify it in your setup.
7. Click the blue add button to add the first EX unit.

If the EX is daisy-chained to another EX unit, you must add the first EX in the chain before the second EX in the chain is displayed, then repeat step 7 to add the second EX in the chain.

8. Click the blue add button to add the second EX unit.
If the EX is daisy-chained to another EX unit, you must add the first EX in the chain before the second EX in the chain is displayed, then repeat step 7 to add the second EX in the chain.

How to Link Three S3-4K Units

Each S3-4K has a single Link card in slot 1, identified by a yellow stripe at the top. Make sure to use the locking mechanism and then push each cable until it locks in place.

Connect the Link cables provided with each S3-4k between the Link connectors as follows:

- VP ID 0, Link Card slot 1, Link 1 >> VP ID 2, Link Card slot 1, Link 2 [1]
- VP ID 0, Link Card slot 1, Link 2 >> VP ID 1, Link Card slot 1, Link 1 [2]
- VP ID 1, Link Card slot 1, Link 2 >> VP ID 2, Link Card slot 1, Link 1 [3]

See image 6-39 for an example of the cabling between three S3-4K units.

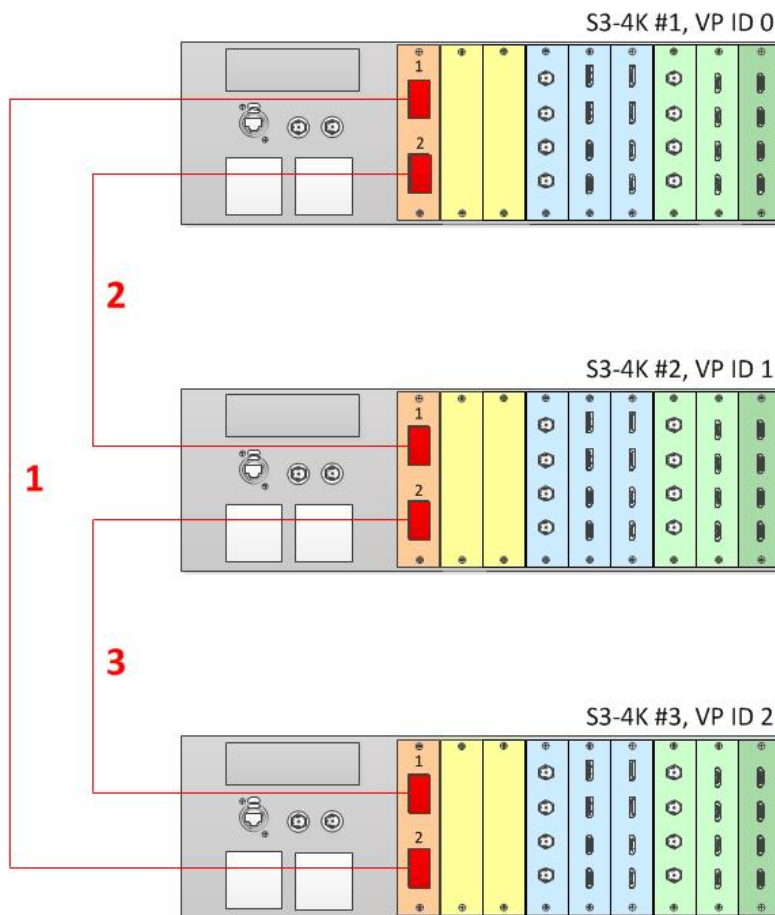

Image 6-42
Cabling between three S3-4K units

Event Master Configuration for Linking Three S3-4Ks

1. Start the Event Master Toolset version 5.1 or higher.
2. Make sure that the three S3-4Ks are discovered on the network and that they have different Unit IDs.
3. Drop one of the S3-4Ks in the GUI.
4. Drop the second S3-4K.
You will be presented the option to add as a new system, add as a master, or add as a slave.
5. Select either add as a master or add as a slave.
6. Drop the third S3-4K.
You will be presented the option to add as a new system, add as a master, or add as a slave.
7. Select either add as a master or add as a slave.
8. (Optional) At this point it is suggested that you select and name appropriately each S3-4K so that you can identify it in your setup.

How to Link an S3-4K Unit and an EX Unit with Two VPU Cards

To add up to eight Single or four Mixing Layers to a system, an S3-4K Unit can be linked to an EX Unit with two VPU cards. This adds two VPUs. Each S3-4K has a single Link card in slot 1, identified by a yellow stripe at the top. Each EX has two Link sockets. Make sure to use the locking mechanism and then push each cable until it locks in place.

Connect the Link cables provided with each unit between the Link connectors as follows:

- S3 VP ID 0, Link Card slot 1, Link 1 >> EX VP ID 1, Link 2 [1]
- S3 VP ID 0, Link Card slot 1, Link 2 >> EX VP ID 1, Link 1 [2]

See image 6-43 for an example of the cabling between an S3-4K unit and an EX unit with two VPU cards.

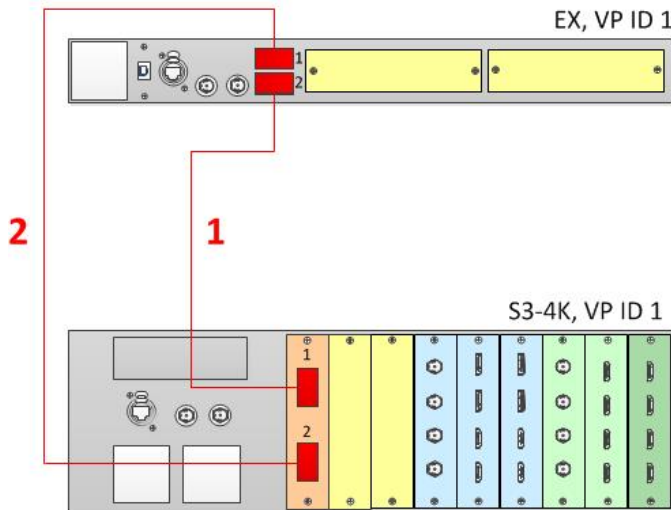

Image 6-43
Cabling between an S3-4K unit and an EX unit with two VPN cards



When an EX unit has VPU cards rather than a combination of Input and Output cards, and it is connected to an S3-4K processor, the EX unit can no longer be daisy-chained to another EX unit; both Link connectors on the EX unit must be connected to the S3-4K Master unit.

How to Link an S3-4K Unit and an EX Unit with a Mixed I/O/VPU Configuration

To add up to four Single or two Mixing Layers to a system, an S3-4K Unit can be linked to an EX Unit with a single VPU card. This adds a single VPU. The VPU can be in either slot 1 or slot 2 on the EX unit, and the other slot may contain either an Event Master Input card or an Event Master Output card. Each S3-4K has a single Link card in slot 1, identified by a yellow stripe at the top. Each EX has two Link sockets. Make sure to use the locking mechanism and then push each cable until it locks in place.

Connect the Link cables provided with each unit between the Link connectors as follows:

- S3 VP ID 0, Link Card slot 1, Link 1 >> EX VP ID 1, Link 2 [1]
- S3 VP ID 0, Link Card slot 1, Link 2 >> EX VP ID 1, Link 1 [2]

See image 6-44 for an example of the cabling between an S3-4K unit and an EX unit with two VPU cards.

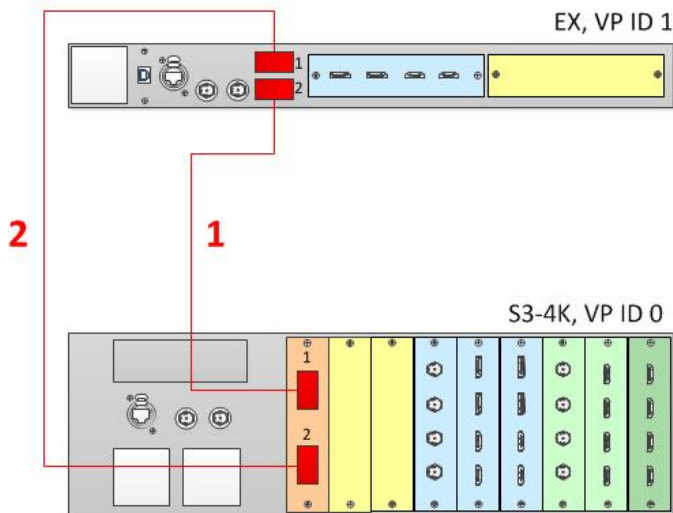

Image 6-44
Cabling between an S3-4K unit and an EX unit with a single VPN card



When an EX unit has VPU cards rather than a combination of Input and Output cards, and it is connected to an S3-4K processor, the EX unit can no longer be daisy-chained to another EX unit; both Link connectors on the EX unit must be connected to the S3-4K Master unit.

Event Master Configuration for Linking an S3-4K Unit and an EX Unit with VPU Cards

1. Start the Event Master Toolset version 5.1 or higher.
2. Make sure that both the S3-4K and the EX units are discovered on the network and that they have different Unit IDs.
3. Drop the S3-4K in the GUI.
If the S3-4K unit is cabled to the EX unit, the EX unit appears as a grayed-out box below the S3-4K unit in the Diagram area. In the grayed-out EX box a blue button allows you to add the EX to the system as a slave.
4. Click the blue add button to add the EX unit.
5. (Optional) At this point it is suggested that you select and name appropriately each unit so that you can identify it in your setup.

How to Link Two EX Units with VPU Cards

To create a system comprising two VPU cards, an Input card, and an Output card, two EX units can be lined together. The system must have two VPU cards; both VPU cards can be on one EX unit, or each EX unit can have a single VPU card and either an Input card or an Output card. Such a system provides four Inputs, four Outputs, four Mixing Layers, and no MVR outputs. Each EX has two Link sockets. Make sure to use the locking mechanism and then push each cable until it locks in place.

Connect the Link cables provided with each unit between the Link connectors as follows:

- EX VP ID 0, Link 1 >> EX VP ID 1, Link 2 [1]
- EX VP ID 0, Link 2 >> EX VP ID 1, Link 1 [2]

See image 6-45 and image 6-46 for examples of the cabling between two EX units with VPU cards.

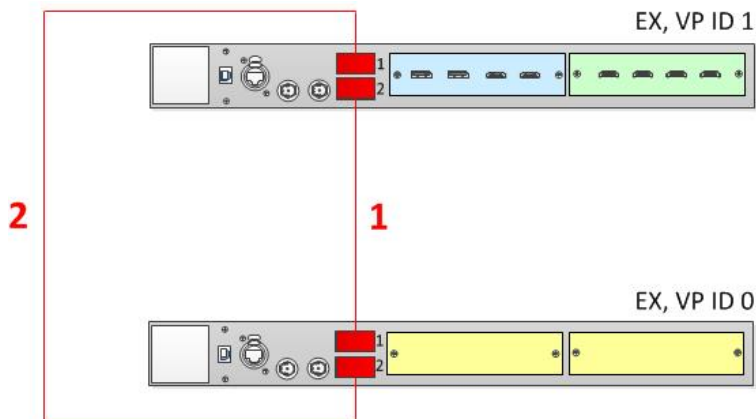

Image 6-45
Cabling between an EX unit with Input and Output cards and an EX unit with two VPU cards

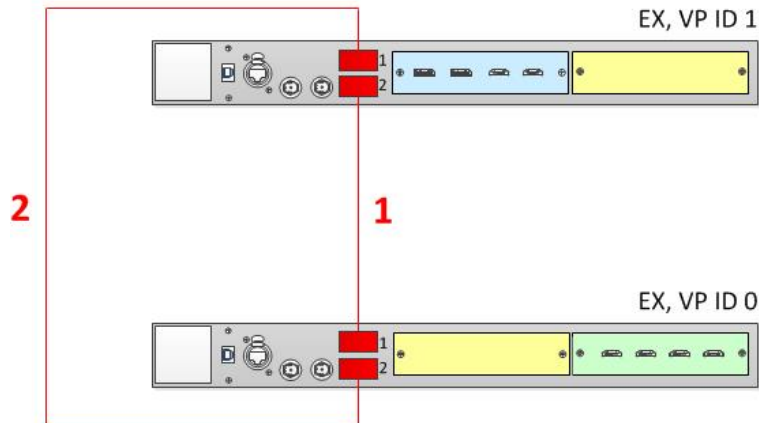

Image 6-46

Cabling between an EX unit with an Input and a VPU card and an EX unit with a VPU and an Output card

Event Master Configuration for Linking Two EX Units with VPU Cards

1. Start the Event Master Toolset version 5.1 or higher.
2. Make sure that both the EX units are discovered on the network and that they have different Unit IDs.
3. Drop the first EX in the GUI.
If the EX unit is cabled to a second EX unit, the second EX unit appears as a grayed-out box below the first EX unit in the Diagram area. In the grayed-out EX box a blue button allows you to add the EX to the system as a slave.
4. Click the blue add button to add the second EX unit.
5. (Optional) At this point it is suggested that you select and name appropriately each unit so that you can identify it in your setup.

Other Linking Configurations: E2 Jr. and S3-4K Jr.

E2 Jr. and the S3-4K Jr. units do not ship with Link cards, but they do not support linking as an upgrade option. To support linking with an E2 Jr. or an S3-4K Jr. unit, you may purchase an Event Master Link card (P/N R9004746) and install it in Slot #1 of the unit. You may also need to purchase additional Event Master Link cables (P/N R9004750).



When linking two E2 Jr. units, the user must buy two Link cards per unit and link the two E2 Jr. units as two E2 units would be linked. A single Link card per unit is required to link an E2 Jr. with an S3-4K Jr. or to link an S3-4K Jr. to another S3-4K Jr.

To link an E2 Jr. unit to another E2 Jr. unit, connect Link cables between the Link connectors as follows:

- VP ID 0, Link Card slot 1, Link 1 >> VP ID 1, Link Card slot 1, Link 2 [1]
- VP ID 0, Link Card slot 1, Link 2 >> VP ID 1, Link Card slot 1, Link 1 [2]
- VP ID 0, Link Card slot 2, Link 1 >> VP ID 1, Link Card slot 2, Link 2 [3]
- VP ID 0, Link Card slot 2, Link 2 >> VP ID 1, Link Card slot 2, Link 1 [4]

See image 6-47 for an example of the cabling between two E2 Jr. units.

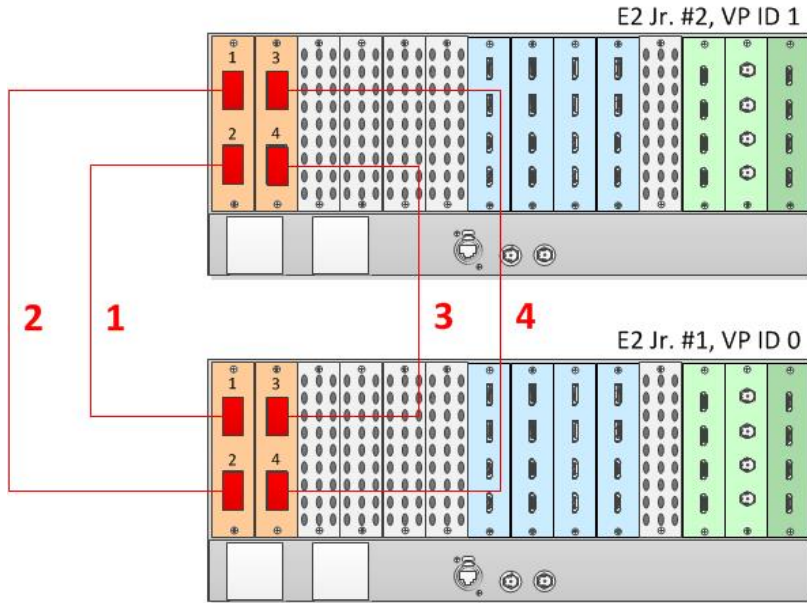

Image 6-47
Cabling between two E2 Jr. units

To link an S3-4K Jr. unit to another S3-4K Jr. unit, connect Link cables between the Link connectors as follows:

- VP ID 0, Link Card slot 1, Link 1 >> VP ID 1, Link Card slot 1, Link 2 [1]
- VP ID 0, Link Card slot 1, Link 2 >> VP ID 1, Link Card slot 1, Link 1 [2]

See image 6-48 for an example of the cabling between two S3-4K Jr. units.

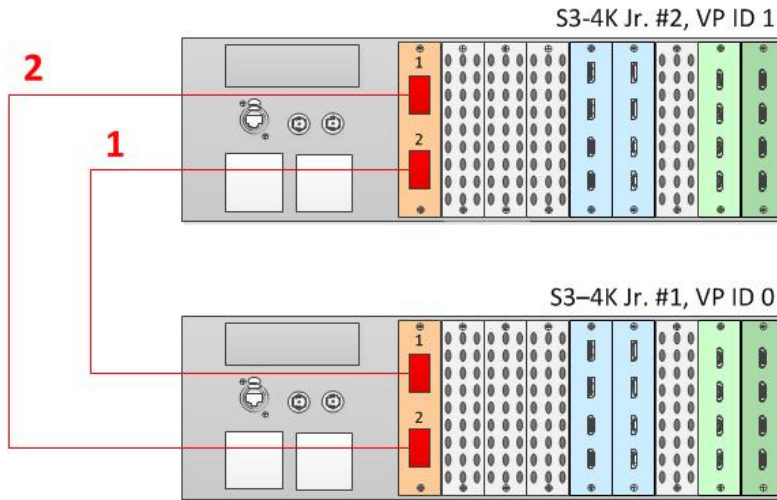

Image 6-48
Cabling between two S3-4K Jr. units

To link an E2 Jr. unit to an S3-4K Jr. unit, connect Link cables between the Link connectors as follows:

- VP ID 0, Link Card slot 1, Link 1 >> VP ID 1, Link Card slot 1, Link 2 [1]
- VP ID 0, Link Card slot 1, Link 2 >> VP ID 1, Link Card slot 1, Link 1 [2]

See image 6-49 for an example of the cabling between an E2 Jr. unit and an S3-4K unit.

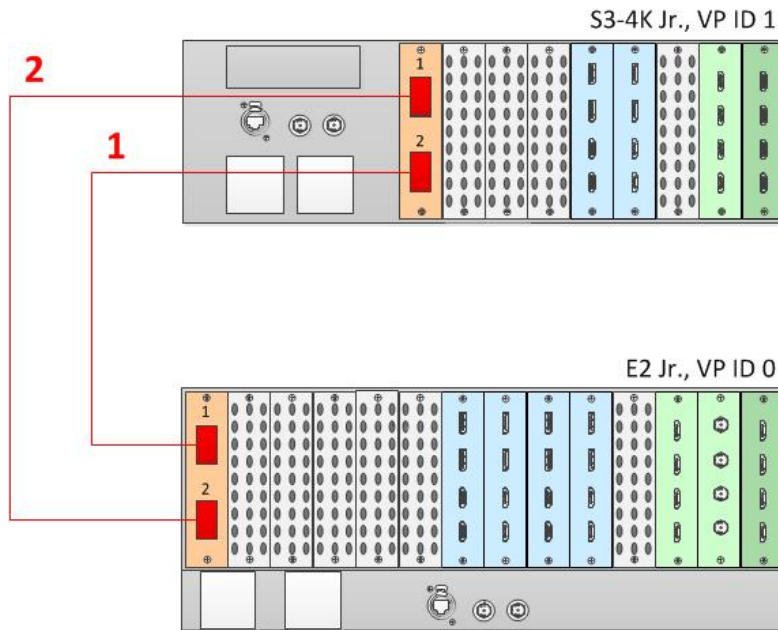

Image 6-49
Cabling between an E2 Jr. unit and an S3-4K Jr. unit

Event Master Configuration

1. Start the Event Master Toolset version 4.1 or higher.
2. Make sure that both units are discovered on the network and that they have different Unit IDs.
3. Drop the first in the GUI.
4. Drop the second unit in the GUI.
You will be presented the option to add as a new system, add as a master, or add as a slave. An S3-4K can be added as a Master or Slave to an E2.
5. Add the second unit as a slave.
6. (Optional) At this point it is suggested that you select and name appropriately each unit so that you can identify it in your setup.

Connection Control

From the configuration page switch from the detail view to the System view and ensure that the status of all connections is good – Green. If any connections are shown red please check that the cables were connected as described in step b and they were fully seated.

Programming

Referring to section "System Setup", page 243, you may now proceed with the configuration and programming of the E2 linked system having full access to all resources from both E2s; a total of 56 inputs, 16 screen outputs, 8 Aux outputs, 4 multiviewer outputs and up to 32 mixer layers.

Auto Creation

If you choose to auto create your inputs, outputs and MVR outputs they will be created from Unit ID 0 first and then followed by the ones from Unit ID 1.

Configuration Order

You may proceed with defining your destinations, auxes and assign your layers. It is recommended that you setup all screen destinations and make layer assignment before you setup the Multiviewer.



The Multiviewer and Web App sections of the Event Master Toolset have an additional selection. You may select whether you are viewing the Master or Slave E2 Multiviewer windows or the Master or Slave E2 Web App. The selection names correspond to the way you named the units in steps above.

Backup and Restore

When backing up and restoring your system you only need to backup and restore from the Master Unit.

Genlock

When genlocking your system to an external sync you only need to bring the signal into the Master unit and select lock to External from the Event Master Toolset.

A note about Multiviewer and Linked Systems

In an E2 linked setup as you create destinations and assign layers the Event Master Toolset determines the best resource allocation for your configuration.

In order to make optimal use of expansion links, screens in linked E2 systems must be viewed on the Multiviewer in the E2 where the Event Master Toolset has allocated it.

Optimal allocation may cause a screen allocation to move from one E2 to another as screen resources are changed.

This may result in a screen already placed in a Multiviewer to not be operative. The Event Master Toolset will change the UMD text to "Screen not viewable on this MVR".

All you need to do is delete the screen from the Multiviewer displaying this message and place it on the other Multiviewer.

A note about Backgrounds

Background sources bigger than one unit should still come in to one of the units, not split between unit as in earlier systems.

More information

For more information on how to prevent cable and connector damage on the Link Cards for E2 and S3-4K, see *InfoT-1294: Cable and Connector Damage on the Link Cards for E2 Series and S3-4K Series Presentation Switchers* on the Technical Downloads tab on the E2 Full-sized Event Master processor web page (URL: <https://www.barco.com/en/Products/Image-processing/Presentation-switchers/Full-sized-Event-Master-processor.aspx?#!downloads>).

For more information on Event Master Link-Cable solutions, see *InfoT-1301: Event Master Link-Cable Solutions for E2, S3-4K, and EX* on the Technical Downloads tab on the E2 Full-sized Event Master processor web page (URL: <https://www.barco.com/en/Products/Image-processing/Presentation-switchers/Full-sized-Event-Master-processor.aspx?#!downloads>).

6.18 Programming Menu

General

The programming page is where the event is set up and everything comes together. Users can define sources from inputs, assign layers and backgrounds into screens and create User keys and presets and more. Once programmed and defined this is where the show is played back as well.

Description

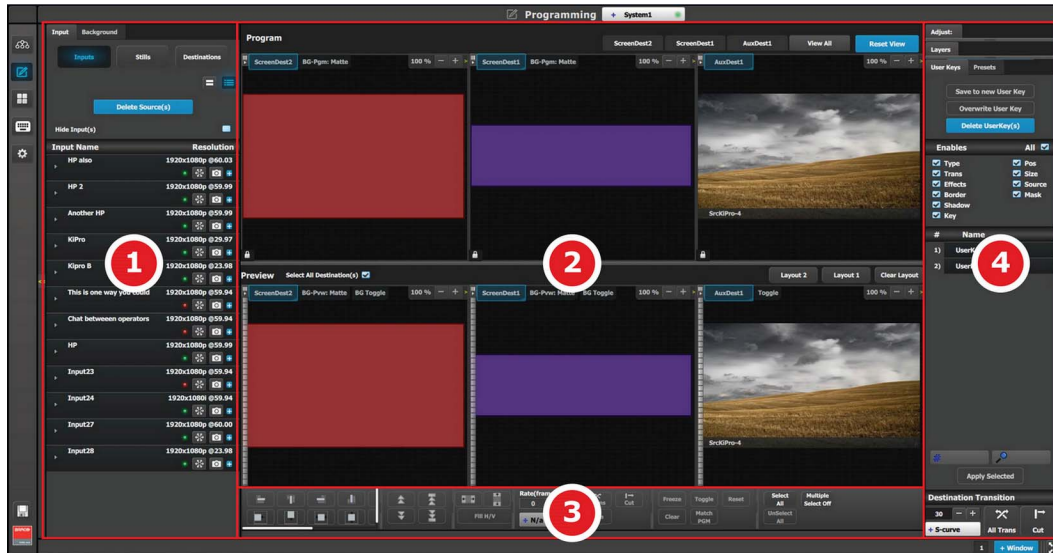

Image 6-50
Programming Menu Overview

1	Resources area	This area contains the available resources for programming and playback, as inputs and sources. Also in this area the still store (logo) images are shown.
2	Workspace / Programming Diagram area	For each destination, super destination, or destination group, the Program and Preview screens can be viewed individually by selecting the corresponding tab. All Program and Previews screens can be viewed simultaneously by selecting the "View All" button. The space between Program and Preview has Layouts, a function where a certain group of destinations can be laid out in the workspace
3	Workspace / System wide function	Layer Alignment adjustments and controls to manage the Preview/Program screens.
4	Adjustment area	The menus in this area provide control of parameters for selected layer and source. These can be modified and managed. This is where creation of User Keys and presets is done

The following sections describe each part of the Programming page in detail:

- "Programming Menu > Resources area", page 174
- "Programming Menu > Diagram area", page 187
- "Programming Menu > Layer Modifier area", page 190
- "Programming Menu > Adjustment area", page 194

6.19 Programming Menu > Resources area

General

This part of the **Programming** page allows users to manage the available input resources. Sources are created and defined from the available Inputs that were defined on the **System Configuration** page.

From Release 1.5 there is Still Stores for Sources, Still Stores for Backgrounds and Destinations for re-entry.

About Sources and Inputs

Source are defined from input signals. Multiple sources can be defined from the same input. After a source is defined, then several attributes can be modified. These attributes are: color adjustments, crop, sharpness and mask. By default, a source is automatically created for each Input. Up to 256 sources can be created from the same input. As with inputs, sources can be defined from multiple connectors, ex: 4K or DL DVI and as a single link or dual link.



The multiviewer displays input signals not sources.

Few words about Inputs, Sources and Layers

Input

- **Definition:** Any video signal connected to the Event Master series processor.
- **Features:**
 - An input signal can be 2K (Single Link), Dual-Link or 4K (Ultra-HD) format.
 - Depending on the resolution and type of the input signal, multiple connectors may be required to connect an input signal to the Event Master series processor. The number of connectors required is listed in the table below.

	2K Resolutions up to 2048x1200@60	Dual Link Resolutions up to 3840x1200@60	4K (Ultra HD) Resolutions up to 4096x2160@60
SDI	1	2	4
DVI	1	1	2
HDMI 1.4a	1	1	2
DisplayPort 1.1a	1	1	2

- **Adjustments:**
 - Name, Colorspace, Connector capacity, Auto Acquire, EDID, Contrast, Brightness, Gamma.
 - Adjustments to an input signal have an effect on all sources that are derived from the input signal

Source

- **Definition:** A video signal created when an input is manipulated to create a desired look.
- **Features:**
 - When an input is created, a source is automatically created with the same attributes as the input.
 - Multiple sources can be generated from the same input signal.
 - Any source can be dropped into any layer and any destination.
 - The same source can be used in multiple layers and multiple destinations.
 - It should be noted that if a source is used in multiple layers and a source is modified in one of the layers, it will not be automatically updated in the other layers. To update the source in the other layers, it needs to be deleted from these layers and re-inserted from the sources list.
- **Adjustments:**
 - Name, Bind to User Key, Layer Aspect Ratio, Size, Position, Contrast, Brightness and Hue.

Layer

- **Definition:** A layer is one image stacked on top of another or a background.
- **Features:**
 - Each mixer layer has two layers, Preview and Program. For complete flexibility, each layer can be assigned to either **PIP** or **Key** functionality.



Image 6-51

- The mixing **Background** layer (**BG**) has the lowest priority. Any input or inputs can be used as a background. This layer visually appears behind all other PIPs and keys. The system can transition between any defined background sources.
- On any mixing layer, a **PIP** layer appears over backgrounds and under other layers of higher priority.
- **PIP** effects include mixes, smooth moves, resizing, adjustable aspect ratio, borders, mask and drop shadows.
- On any mixer, a **Key** layer also appears over backgrounds and under other layers of higher priority. Key effects include luminance keys, split keys (cut and fill), and chroma keys.
The **Cut + Fill** Key can use PNGs with transparency. The system detects the transparency as the "Cut" signal and the non-transparent portion of the PNG as the "Fill" input. Any Still that has transparency is marked with a "T" indicator beside the name of the Still.
- **Adjustments:**
 - Border, Shadow, Layer Size & Position, Source Size & Position and Mask.
- **Layer Effects**
 - Strobe, Flip, Freeze, Layer Color Effects, Monochrome and Invert.

Input, Sources and layer example

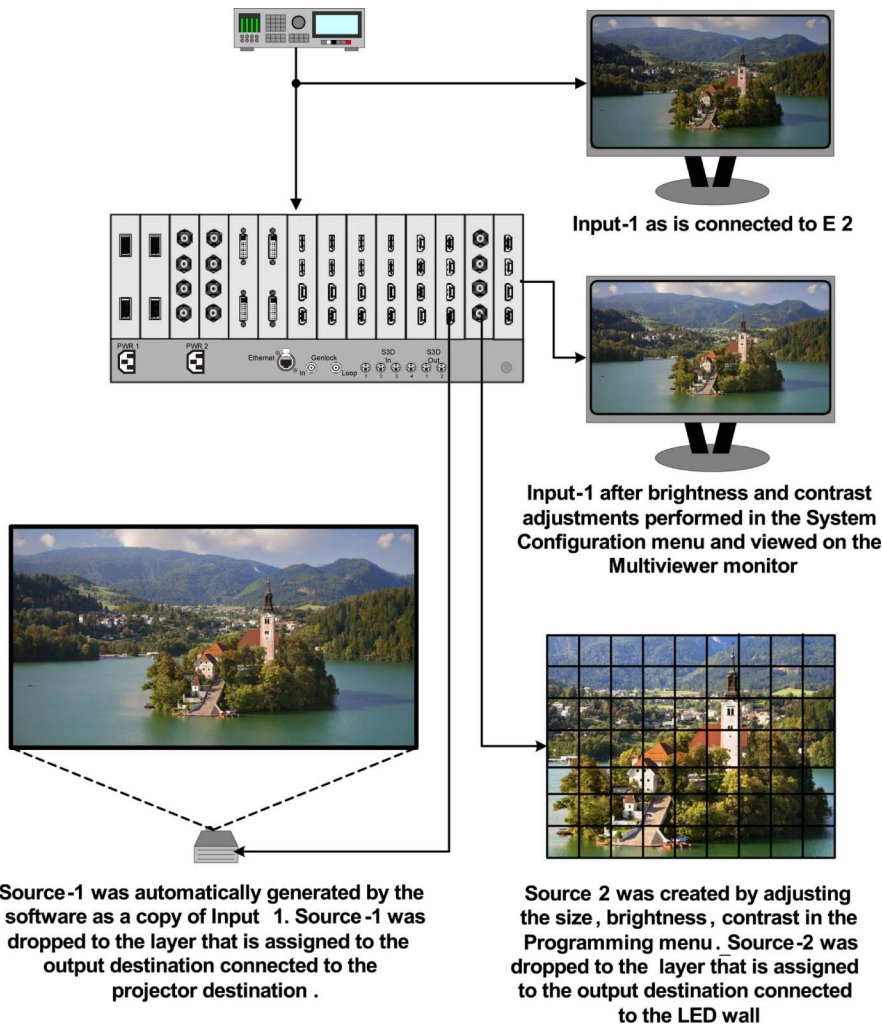

Image 6-52

Source Area description

In this menu, Sources defined in the Configuration menu are assigned to destinations via drag and drop procedure. Each input has minimum one Source file, several can be created via copy original (**Plus** Icon) or copy file (**Double Page** Icon).

There are 2 tabs in this section:

- **Source:** Lists Inputs and Sources available in the system. Sources are listed after the input and can be view by clicking on the arrow next to the Input name. Stills and Destinations can also be used as sources.
- **Background:** Lists backgrounds and background still stores available for destinations.

For each of these lists two display modes are available. Toggle the view by clicking on appropriate icon:



List View





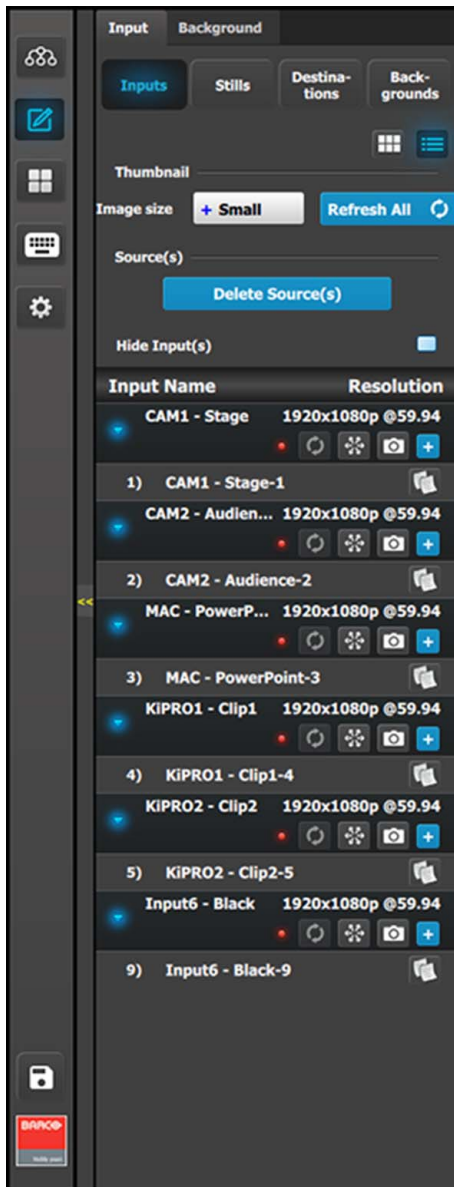

Thumbnail View

Inputs (List view)

Inputs (List view)



- Resolution: This is the resolution of the Input signal.
- The LED color indicates the status of the input:
 - Red: Sync is missing or invalid format.
 - Green: Sync is valid.
-  Refreshes the Input thumbnail (in Thumbnail View) from the Input source.
-  Freezes the Input.
-  Allows a snapshot to be taken and stored as a Still.
-  Adds Sources based on the inputs. A total of 256 are allowed per input.
-  Copies the Source into a new Source and adds it in the list.

Inputs (Thumbnail view)

Thumbnails are added manually and in the future added from the Event Master series processor to the GUI. From Release 1.5 this works for Stillstores.

Inputs (Thumbnail view)

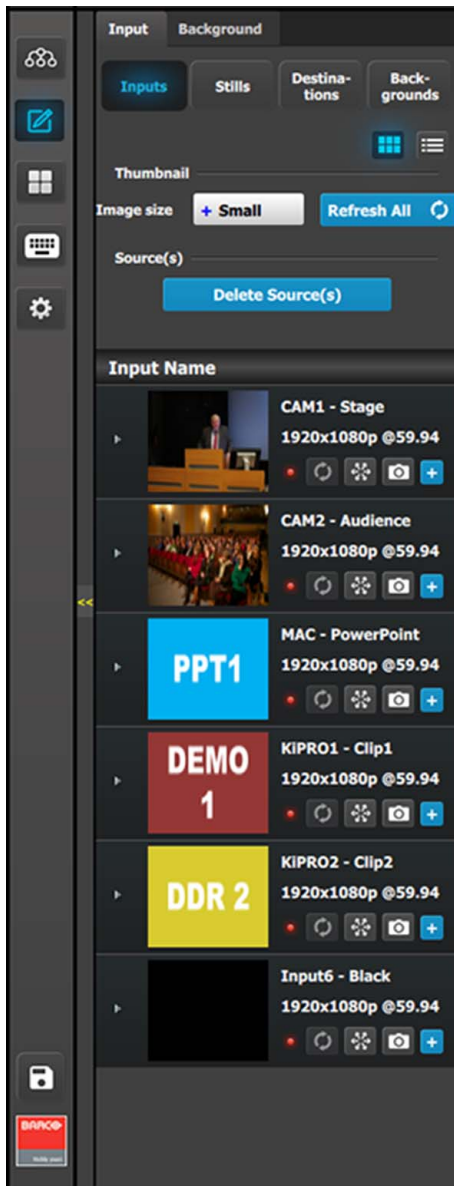

- Behavior is similar to the List View mode (see above).

By clicking in thumbnail area images can be imported using the file picker menu. The picker can select pictures with the BMP, JPG or PNG format.

Stills (List view)

Stills (List view)

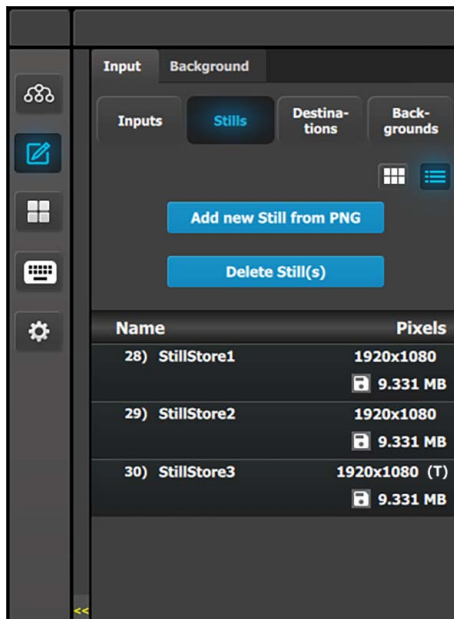

- Stills can be added from external source of the GUI computer in the PNG format. A PNG with a transparency is marked in the Stills list with a (T).
- Name that can be changed by double click action and then the resolution of the Stillstore.
- [Disk Icon] indicate the memory required for the Stillstore. A total of 100 HD Stillstores are possible. Higher resolution images use more memory per image, resulting in fewer still images being available on the system.

Stills (Thumbnail view)

The system automatically adds thumbnails once the live capture or file import has been processed.

Stills (Thumbnail view)

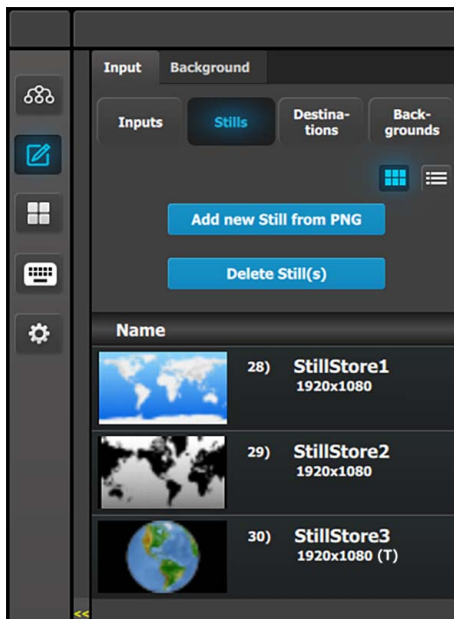

- Behavior is similar to the List View mode (see above).

By clicking in thumbnail area images can be imported using the file picker menu. The picker can select pictures with the BMP, JPG or PNG format.

Destination

Destination (List view)

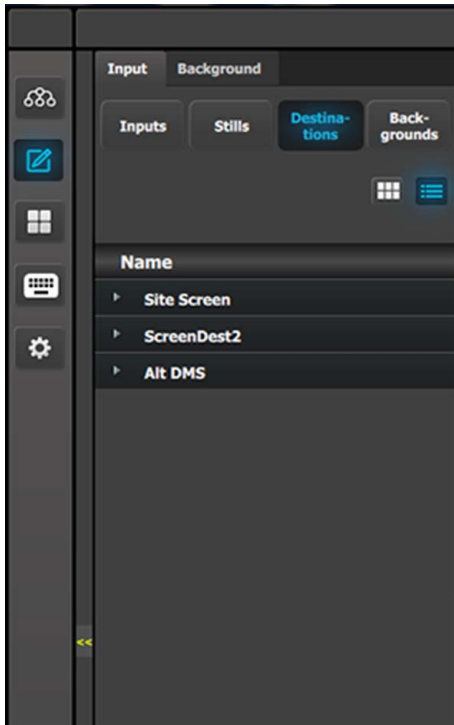

Destination (Thumbnail view)

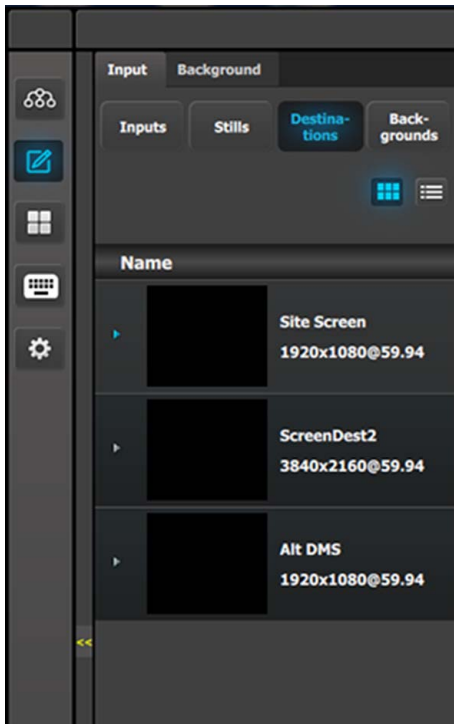

The Destinations can be used as a source in Layers provided they have the capacity to fit. Up to 2K resolutions on SL, up to 4096 x 1200 / 2560 x 1600 for DL and 4K / 8192 x 1200 for 4K Scaler Mode.

How to delete sources

The delete process is similar for all lists with more than one entry. To delete Sources the user need:

1. Click on the **Delete Source(s)** button.

The **Delete Source(s)** button turns in red and the delete icon (“x”) appears next to the copy icon on each element of the source list.

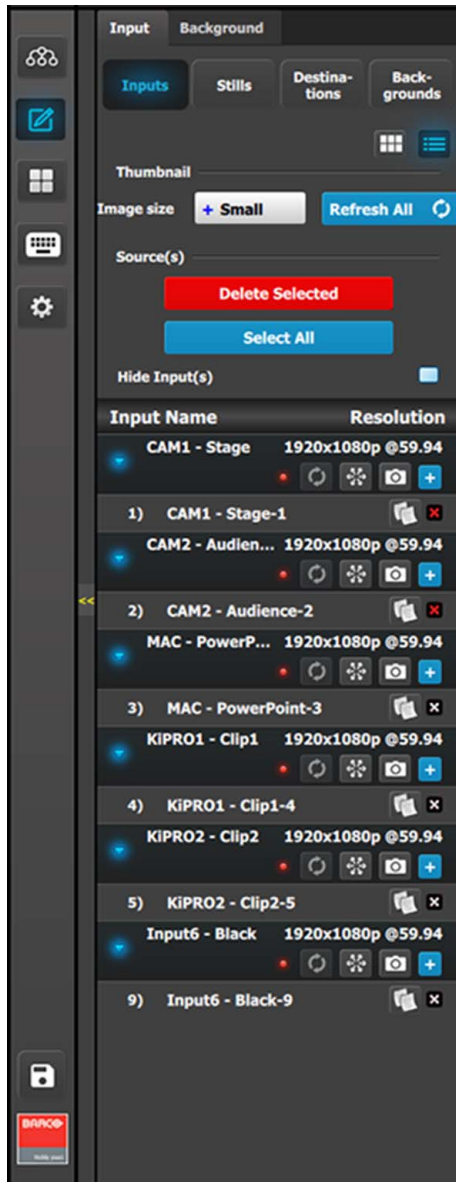

Image 6-53
Delete Selected Input sources

2. Select the sources that you desire to delete and click the **Delete Source(s)** button.

The selected sources are removed.

How to hide Inputs

As the inputs are usually named after its physical names while the sources are named after the Show Usage we allow to hide the inputs from the list:

1. Check the **Hide Inputs** box.

Sources are displayed without their associated Inputs.

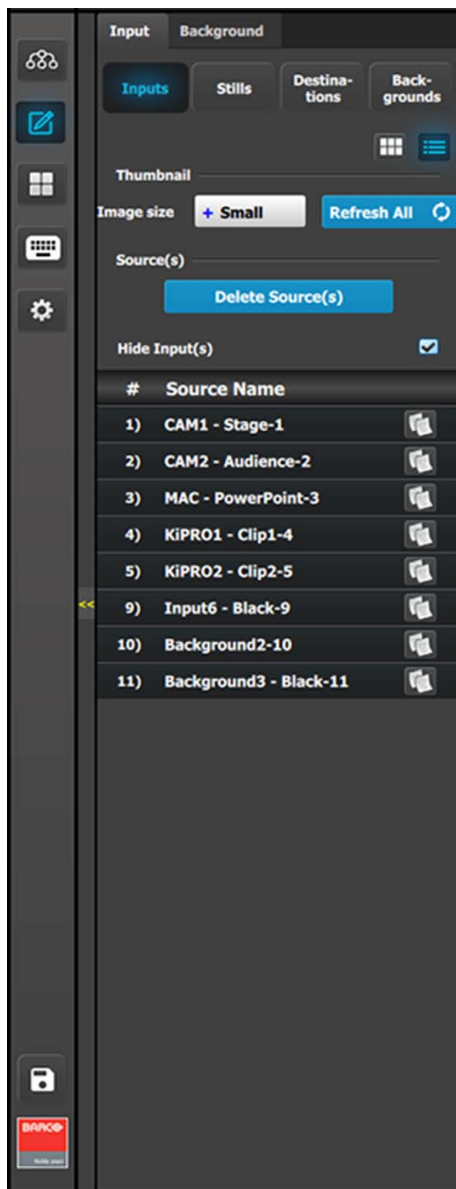
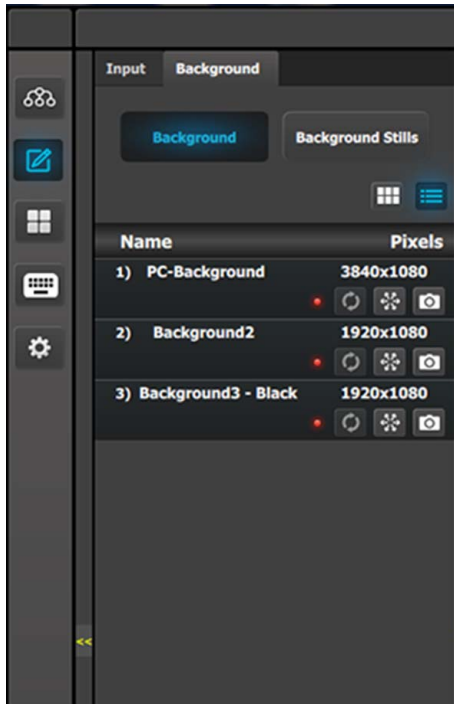

Image 6-54
Hide Input(s) checkbox

Background

In this menu, Backgrounds defined in the Configuration menu are assigned to destinations via drag and drop procedure.

Backgrounds and Destinations need to have the same resolution without the Destinations eventual blend overlap. For example, if a background is defined as an input with 3840 x 1080, then the destination must also have the total resolution of 3840 x 1080.

Background (List view)

- Name: This is the Name of the Input as created in the Configuration of the system.
- Resolution: This is the resolution of the Input signal.
- The LED color indicates the status of the input:
 - Red: Sync is missing or invalid format.
 - Green: Sync is valid.
- [Snowflake Icon] Will freeze the input.
- [Camera Icon] Allows for a snapshot to be taken and store it as Still.

Thumbnails are added manually and in the future added from the Event Master series processor to the GUI. From Release 1.5 this works for Stillstores.

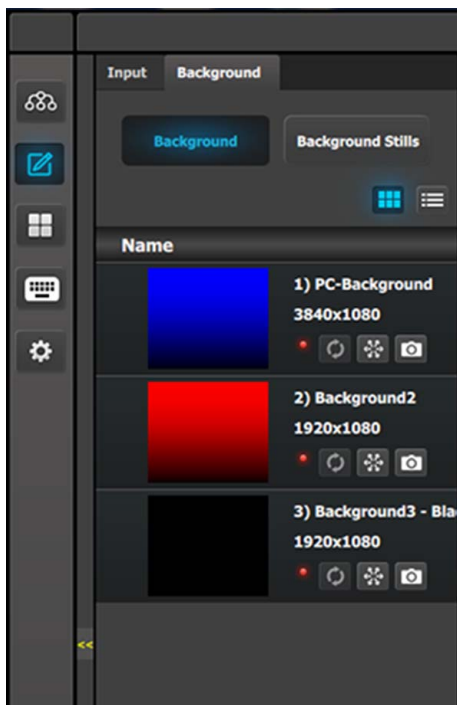
Background (Thumbnail view)

- Behavior is similar to the List View mode (see above).

By clicking in thumbnail area images can be imported using the file picker menu. The picker can select pictures with the BMP, JPG or PNG format.

Background Stills

In this menu, Background Stills captured in the Background Source menu are assigned to destinations via drag and drop procedure.

Background Stills and Destinations need to have the same resolution including the Destinations eventual blend overlap. For example, if a background Stillstore is captured as 3500 x 1080, then the destination must also have the blend resolution of 3500 x 1080.

Background Stills (List view)

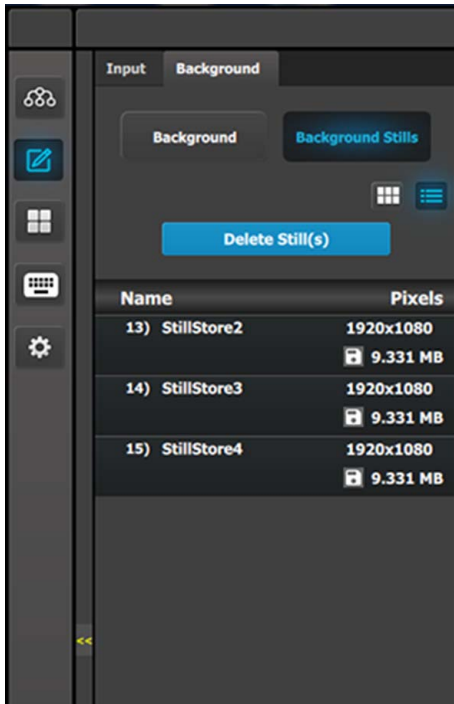

- Name: This is the Name of the Stillstore as created in Background menu. Name can be changed by double click action.
- Resolution: This is the resolution of the Stillstore.
- [Disk Icon] Indicates the memory required for the Stillstore. A total of 100 HD Stillstores are possible. For higher resolutions the corresponding increase of memory is used.

Thumbnails are added manually and in the future added from the Event Master series processor to the GUI. From Release 1.5 this works for Stillstores.

Background Stills (Thumbnail view)

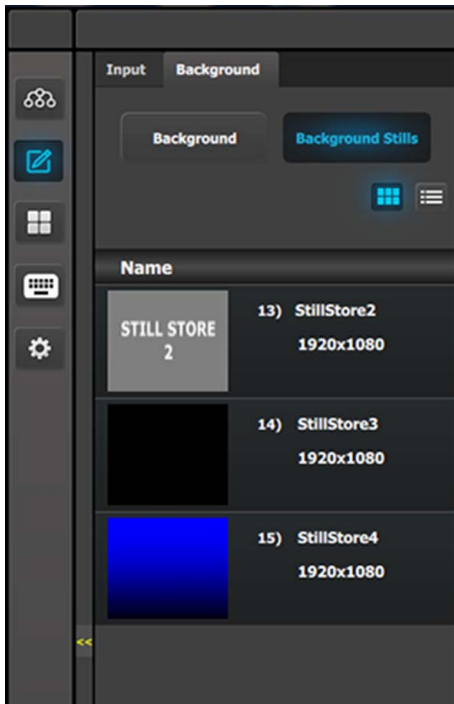

- Behavior is similar to the List View mode (see above).

By clicking in thumbnail area images can be imported using the file picker menu. The picker can select pictures with the BMP, JPG or PNG format.

Input > Backgrounds

The Input tab has a Backgrounds subtab. This Input > Backgrounds subtab is similar to the Background > Background subtab, and it has both a List view and a Thumbnail view.

Input > Backgrounds (List view)

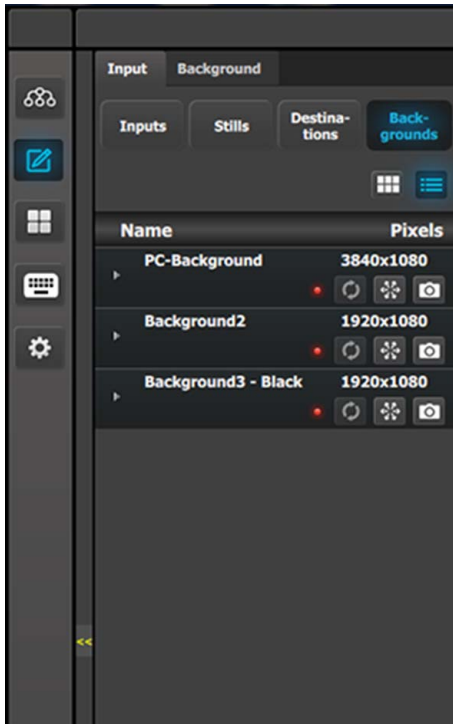

- Name: This is the Name of the Input as created in the configuration of the system.
- Resolution: This is the resolution of the Input signal.
- The LED color indicates the status of the input:
 - Red: Sync is missing or invalid format.
 - Green: Sync is valid.
- [Snowflake Icon] Freezes the input.
- [Camera icon] Allows for a snapshot to be taken and stored as a Still.

Input > Backgrounds (Thumbnail view)

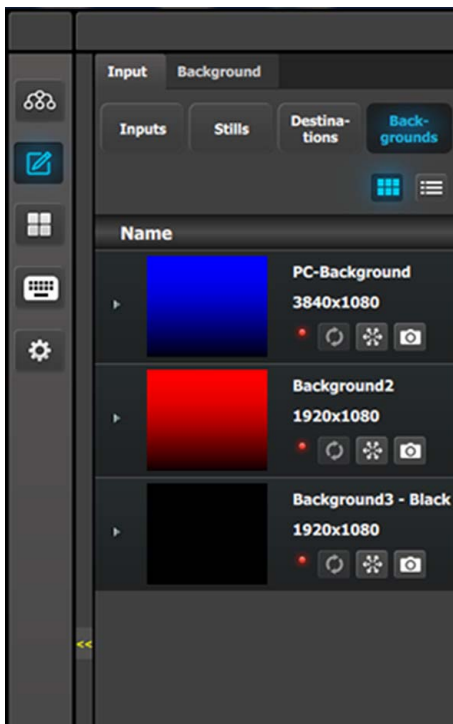

- Behavior is similar to the List view mode (see above).

Backgrounds as Inputs

The Input > Backgrounds subtab allows the Event Master series processor to use Backgrounds as Inputs. This subtab can be used on any Event Master processor, but it is especially useful on a limited-resource processor, such as an S3-4K Jr. processor. An Input defined as a Background can now be used as a Background, or as a source on an AUX Destination or Screen Destination layer.

To use a Background as an Input, follow this procedure.

1. Go to the Programming menu.
2. Go to the Input tab of the Resources area, and then go to the Backgrounds subtab of the Input tab.
3. Drag a Background from the list on the Backgrounds subtab and drop it on any Screen or AUX Destination in the Programming Diagram area that has at least one source layer assigned to it.
If no source layer is assigned to the Destination, you will have to go to the Background tab and drag and drop the Background from the Background subtab.



Using a Background as an Input incurs an extra frame of delay. Use normal Inputs if this delay is unacceptable.



Sources dropped into a Layer must be dropped from the Input tab, while sources dropped into a Background must be dropped from the Background tab.

6.20 Programming Menu > Diagram area

General

The middle of the Programming Page is the Programming diagram area where the **Program**, **Preview** and **AUX** screens are composed.

Description

Each Program/Preview screen can be viewed individually or all of the screens can be shown simultaneously by selecting the corresponding tab on the top of the Program window.

On the top left corner has a label that shows the name of the destination.

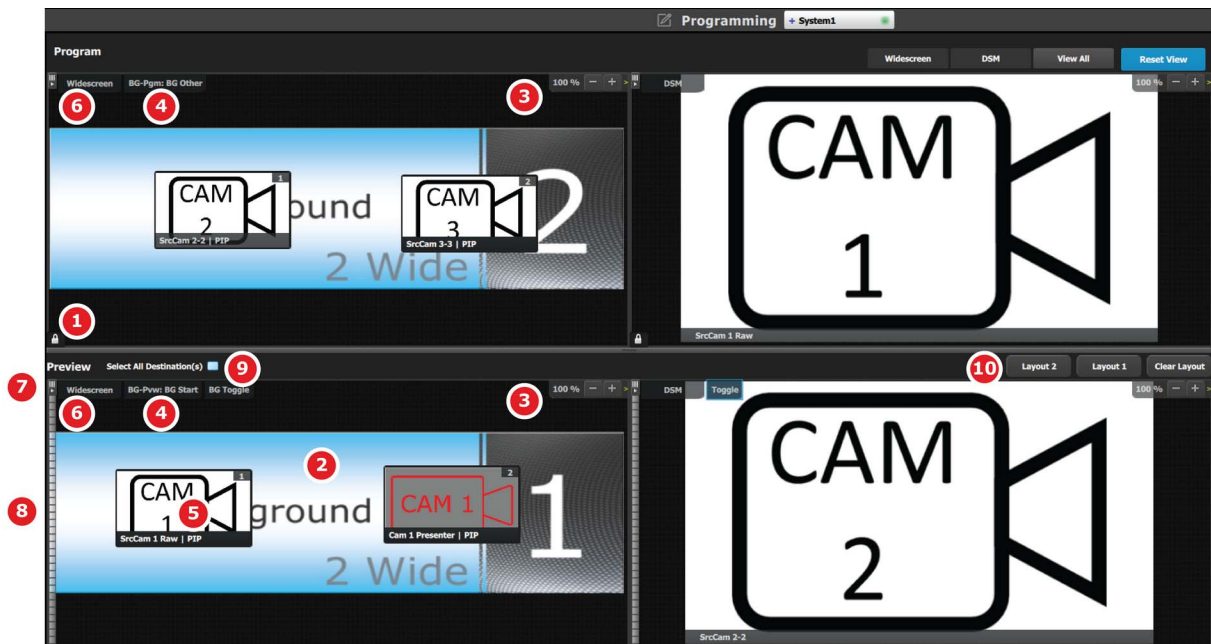

Image 6-55

- 1 Lock icon indicates whether the PGM destination is locked. When locked, the Program screen can only change after a Mix or Cut transition. When the program screen is unlocked, the user can click on a layer that is on PGM and move or resize it. The user can also assign a different Source into that layer or adjust the background.
- 2 Preview screen where the program is composed before is transitioned to program.
- 3 Users can zoom in / out of the diagram area, in from 25% to 150%, in 25% increments.
- 4 BG Input tab. This is the menu where users drop the assigned Background inputs preview screens.
- 5 Selected sources are dropped in the layers defined in the preview screen. A layer can be placed outside or partially in the preview area.
- 6 The Destination tab can be clicked to arm the Destination and become part of the next transition.
- 7 A small arrow on the left hand side of Destination name expands or collapses the Destination view.
- 8 Users can manually control the transition by clicking on the bar or by sliding the mouse.
- 9 Select all Destinations allow to quickly select or unselect all Destinations for Transition.
- 10 Layouts allow for custom layouts of destinations in the programming page.

Layer and Source into the previous screen

Users can drag layers to the preview screen as long as the layer is not on program. In the example below, since no source has been assigned to the layer, the layer will be black and default to a square shape.

6. EM GUI orientation

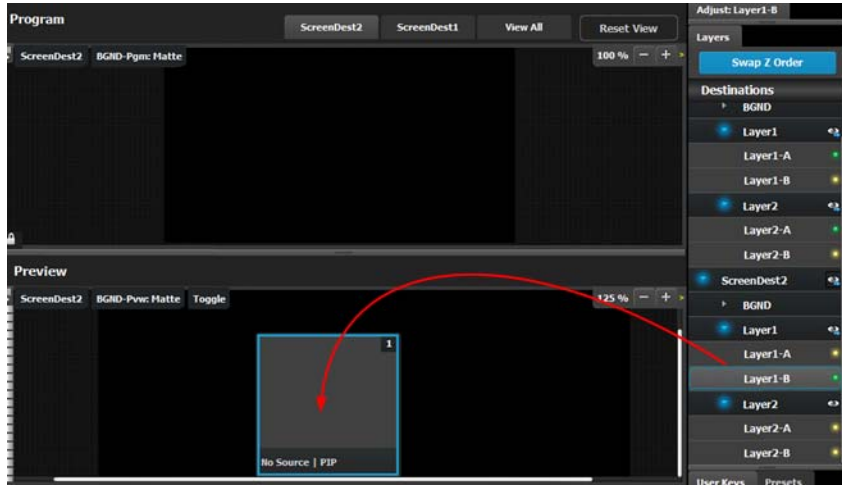

Image 6-56

Next a source from the Input panel on the left hand side can be dragged into the layer.

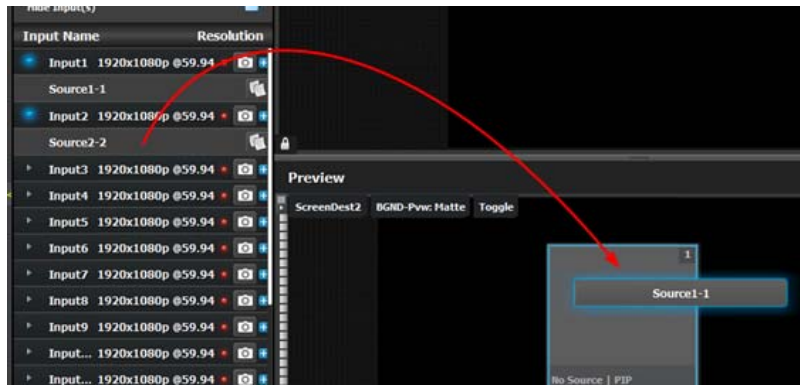

Image 6-57

Alternatively, an Input or a source can be dragged into the Preview screen directly as long as there are available layers.

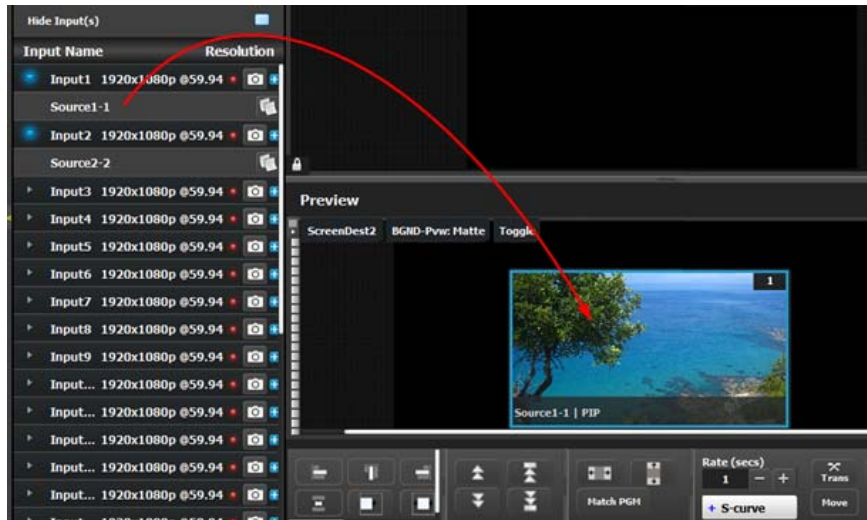

Image 6-58

If the available layer is already in Preview, then the source will immediately be assigned to that layer. The layer will be resized automatically to match the source aspect ratio.

If a layer is available but it hasn't been placed into the preview screen, then the software will automatically place the layer in the position where the Source was dropped and allocate the lowest unassigned layer to the source. The source and layer must also comply with the sizing rule that is explained next.

Rules for assigning Sources into layers

The size of the layer scaler mode has to be greater or equal to the size of the source. For example, if the source is a 2K input, the layer scaler mode needs to be 2K or more. If the source is a 4K and the layer is only a 2K layer, then the source can't be placed into the Layer. If the Source is a 2K input and the layer is a 4K layer, the source can be placed into the Layer.

Scaler mode for layers are set in the Configuration Page, towards the bottom.

Z-Order

The layer priority (z-order) is based by the order they are added in destination menu. The layers that are added first have the lowest priority. For example; layer1 is lower priority than layer2. Layer2 is lower priority than layer3.

Freeze

A layer can be individually frozen by selection and freeze button in the bottom of the workspace menu.



Note: When a layer is frozen, the outline and the text become blue and an icon of a snow flake appears in the bottom right hand corner. Also note that a frozen source will not show the same indication.

Layer adjustments in the Preview Screen

Users can also left click on a layer to move it around inside the Preview screen. A layer can also be moved with the keyboard's arrow keys.

Size adjustments can be performed by selecting and right clicking the vertical, horizontal or any corner of the layer. Any size adjustment maintains the aspect ratio.

These operations can also be performed on multiple layers. Activate Multiple Select to "Multiple Select On" below the workspace to the right. Now each layer can be selected or unselected with a Left click or touch input.

Selected layers are highlighted with a blue border.

AUX Destination Canvas

Assigning inputs/sources to AUX destination works the same way as in the screen destinations within the constraints of the AUX destinations. Only one input can be assigned to each destination and it is always at full screen. Assigning a new input to the destination, overrides the previous input.

Scaler mode for Auxes are set in the Configuration Page, towards the bottom

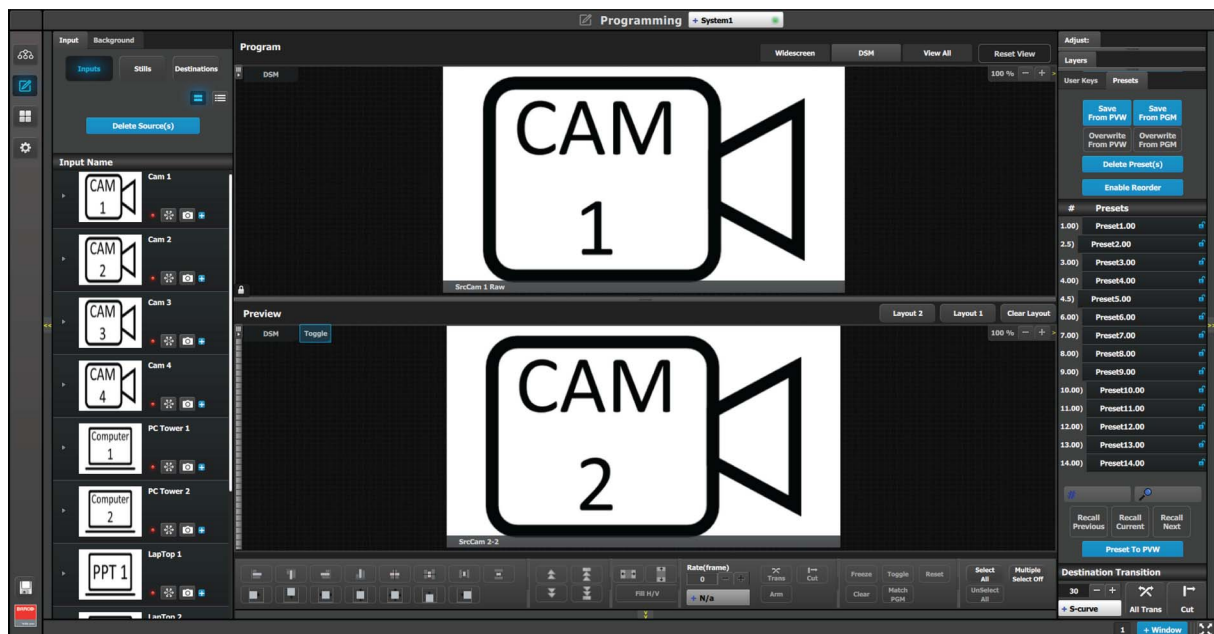

Image 6-59

6.21 Programming Menu > Layer Modifier area

General

This area is specifically for layer adjustments.

Description

The area is broken up into several sub areas. The left side is for alignment, priority, size and position of the layer. Middle is for layer transition. The right is for misc. operations.



Image 6-60

Buttons in this area operate on selected layers in the preview destinations. If no layers are selected, all buttons in this panel is disabled, except for the “Select All” button. “Select All” selects all the layers in preview for the Destinations in the current view, regardless whether the Destination is armed or not. The area is divided into several sections. Detail description of each section is provided below.

Alignment

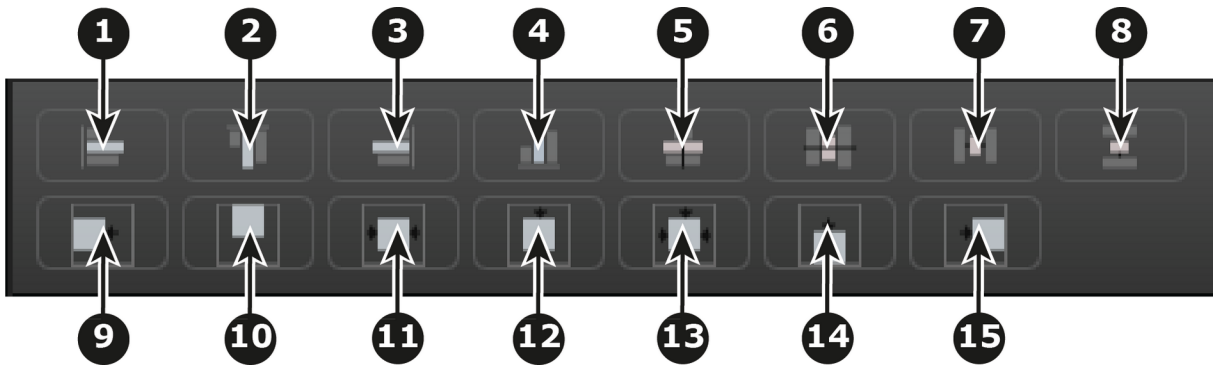

Image 6-61

- 1 Align Left to align the left edges of all selected PIPs.
- 2 Align Top to align the top edges of all selected PIPs.
- 3 Align Right to align the right edges of all selected PIPs.
- 4 Align Bottom to align the bottom edges of all selected PIPs.
- 5 Align Centers Horizontally to align the horizontal axes of all selected PIPs.
- 6 Align Centers Vertically to align the vertical axes of all selected PIPs.
- 7 Space horizontally & uniformly -reference is the horizontal size of the screen.
- 8 Space vertically & uniformly - reference is the vertical size of the screen.
- 9 Align all selected PIPs along the destination’s left edge.
- 10 Align all selected PIPs along the destination’s top edge.
- 11 Center Horizontally to center all selected PIPs horizontally, along the destination’s vertical axis. PIPs do not change vertical position.
- 12 Center Vertically to center all selected PIPs vertically, along the destination’s horizontal axis. PIPs do not change horizontal position.
- 13 Center to center all selected PIPs vertically and horizontally, along the destination’s horizontal and vertical axes.
- 14 Align all selected PIPs along the destination’s bottom edge.
- 15 Align all selected PIPs along the destination’s right edge.

Priority

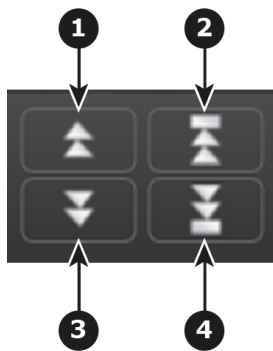

Image 6-62

- 1 Moves the selected layer up in priority and swaps with the layer previously above.
- 2 Moves the selected layer to the top of the priority and swaps it with the layer previously on top.
- 3 Moves down in priority and swaps the z-order of the selected layer with the layer previously below.
- 4 Moves the selected layer to the bottom of the priority and swaps it with the layer previously at the bottom.

Example:

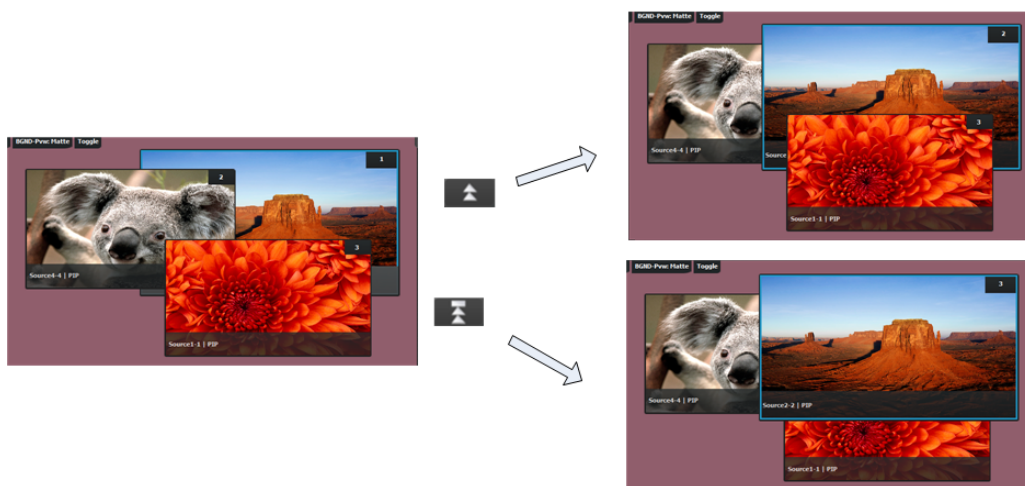

Image 6-63



Only the visual priority (on Preview) of the two layers changes. The layers remain at their current locations — only the priority changes.

Size and Position

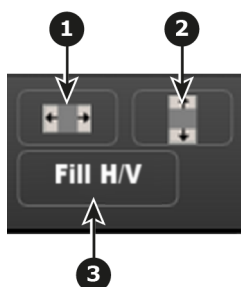

Image 6-64

6. EM GUI orientation

- 1 **Full Screen Vertical** takes the selected PIP(s) to full screen, using the source's height as the guide. If borders are on, they will be taken into account so that they are visible.
- 2 **Full Screen Horizontal** takes the selected PIP(s) to full screen, using the source's width as the guide. If borders are on, they will be taken into account.
- 3 **Fill H/V** will stretch the selected layer over the whole destination size not respecting the aspect of the source.

Resize example:

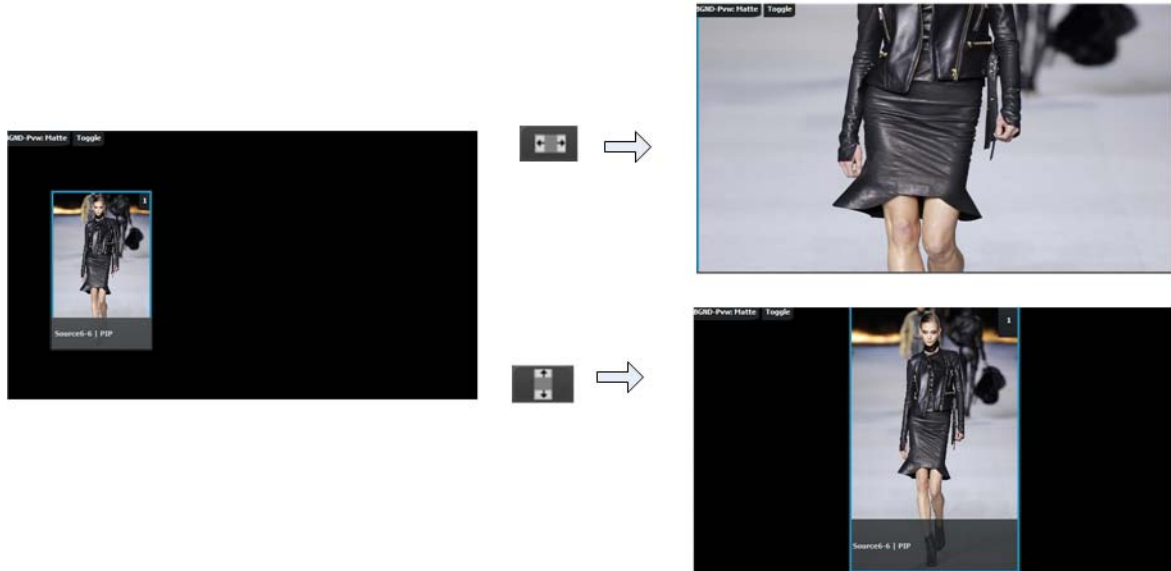

Image 6-65

Match example:

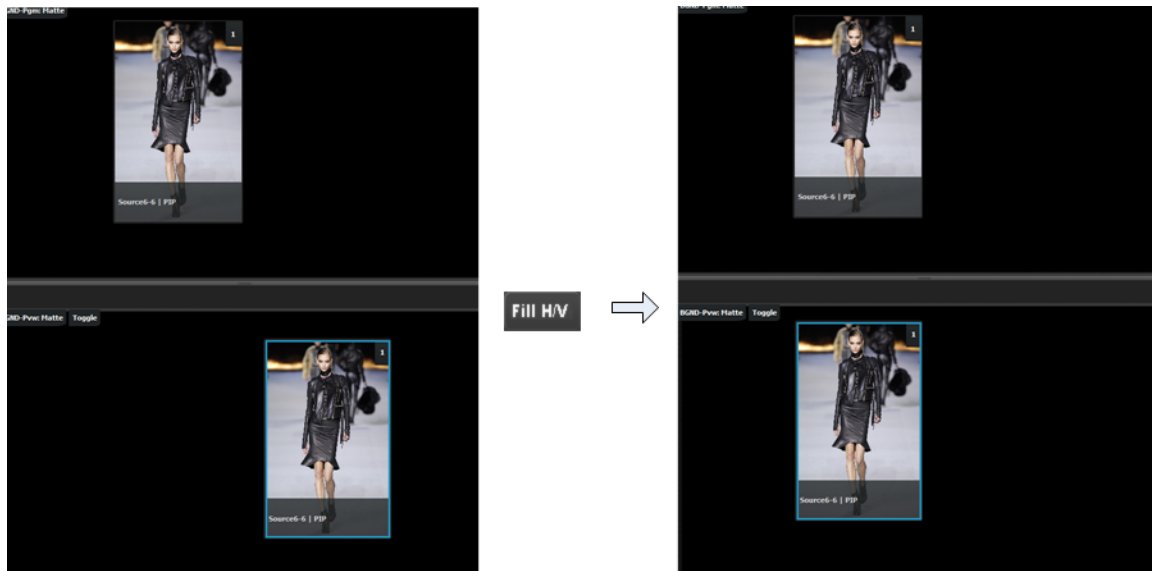

Image 6-66

Transition

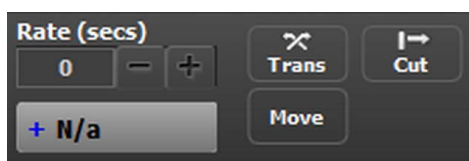

Image 6-67

Trans

Preview transitions to Program according at the rate indicated in the rate box following the s-curve pattern. The layer on Program does NOT fade in preview at the same time. The layer on Program appears in Preview when the transition is completed.

Cut

Instantly transitions the Preview to Program

Move

Enables moves for selected that have one or more keyframes. Move rate is determined in the layer adjustment panel.

S-curve

Four transition types are available: Linear, S-Curve, Logarithmic and Exponential

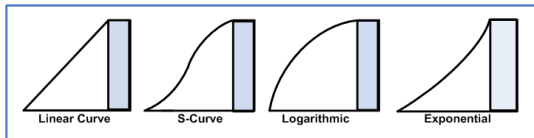

Image 6-68

Miscellaneous operations



Image 6-69

Freeze

Freezes the image that is displayed in the layer. The layer can still be positioned and sized within the destination. The text of a frozen layer turns blue and a "freeze" icon (snowflake) appears on the bottom right corner.

Reset

Positions the layer in the center of the destination. Vertical size is set to 500 pixels and horizontal size is set to maintain the layer's aspect ratio.

Clear

Removes the selected layer from preview. If the selected layer is on program, this button is disabled unless the Program is unlocked.

Toggle

Enables the sources to toggle back and forth with each transition.

- **Toggle on:** After a transition is performed, a different source can be selected for preview. Once the first source transitions off Program, it "flip-flops" to Preview. Subsequent transitions alternate between sources. Another new source can also be selected in Preview, and as long as Toggle is on, the last two selected sources will alternate.
- **Toggle off:** The source selected in Preview stays in Preview, once the transition is complete. Here, sources must be changed manually. If the PIP in Preview has a different source than the PIP in Program, the moment Toggle is turned off, the PIP in Preview automatically changes its source to match Program.

Match PGM

Match PGM button forces the selected layer on Preview to be in the same location as the layer in Program.

Select All / Unselect All

- **Select All:** Selects all Layers in Preview. It is equivalent to left clicking on all unselected layers on Preview one at a time while Multiple Select is On.
- **Unselect All:** Unselects all Layers in Preview. It is equivalent left clicking on all selected layers on Preview one at a time while Multiple Select is On.

Selection of anything allows the selected objects on Destinations to be armed.

6.22 Programming Menu > Adjustment area

General

Situated on the right hand side of the screen is the Adjustment area. In this area users can configure **Layers** and **Sources** and create **User keys** and **Presets**.

Description

There are several tabs in this area:

- **Layers** : Provides a list of the destinations. Under each destination a list of assigned layers and the background is provided.
- **User Keys** : Provides a list of user keys. User keys contains all (or a portion) of the current layer's attributes (such as border color, size, effects, etc.). User Keys are not applicable for AUX Destination.
- **Presets** : List of Presets. Presets contains a group of Destination worth of information.
Note: Not all settings composing a layer is a layer setting, but a Source File setting. Be aware that for desired result a USER KEY might have to be bound to a preset.
- **Adjustment** : Based on what is selected in the Preview or Program canvas area, this is the panel where we are adjusting what is selected. For example if we select Layer1, we will be adjusting Layer1 settings.
- **Source Adjustment**: This panel is shown on the Adjust panel when a layer with a valid Source is selected.

At the bottom of the area, there is a set of buttons allowing execute transition actions on selected Destinations.

The following sections describe each panel of this area in detail:

- "Programming Menu > Adjustment area > Layer configuration", page 195
- "Programming Menu > Adjustment area > Background configuration", page 206
- "Programming Menu > Adjustment area > User Keys configuration", page 208
- "Programming Menu > Adjustment area > Presets configuration", page 210
- "Programming Menu > Adjustment area > Source adjustment", page 213
- "Programming Menu > Adjustment area > Global Transition Rate/Trans/Cut", page 215

6.23 Programming Menu > Adjustment area > Layer configuration

General

In the Layer menu, users can manage the layer in the selected destination and update its attributes.

Layer configuration menu description

Layer configuration menu is accessed by clicking on the Layer tab.

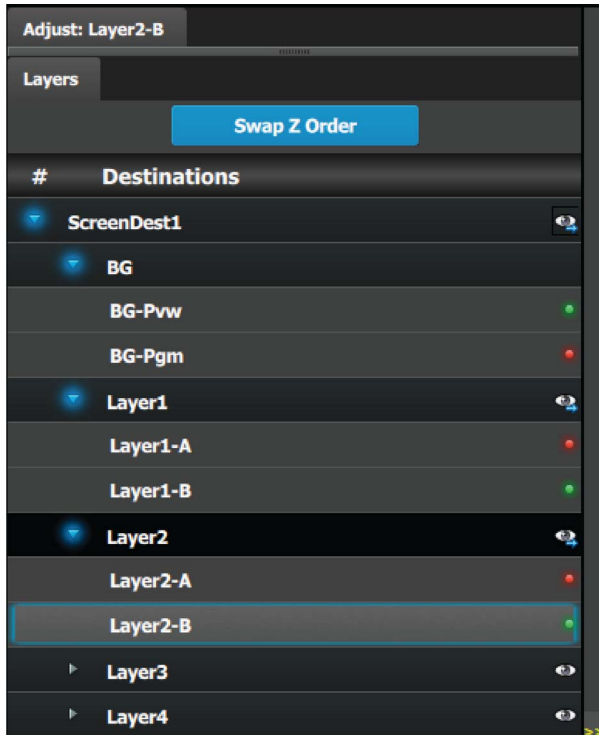

This menu provide:

- A list of the available destinations and the layers associated with that destination.
- **Swap Z order** button that allows for layers that are in the same Destination and of the same type to be swapped.

List of destination:

- **Destinations:** Provides list of all destinations that are available in the Programming page. Each destination can be expanded to reveal the Background and the layers assigned to them. The “eye” icon replaces or removes the layers from the Preview destination. This button works in a toggle mode.
- **BG and ScreenDest:** Backgrounds and Destinations layers can be further expanded to reveal the A and B sources that are used in the transitions.
- **LEDs:** The LEDs provide an indication of the “A” and “B” backgrounds or sources. Note that there is no A or B side of the scaler, only A and B usage, all layers are independent of each other in respect to Z-order.

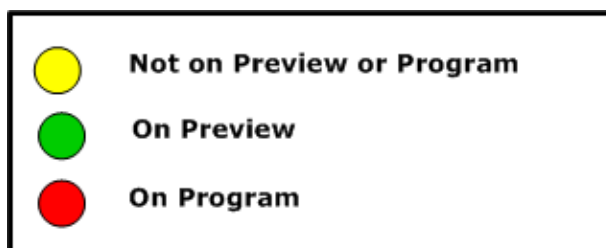

Image 6-70

Swap Z order rules

There are several rules that apply when changing Z order:

1. Can only swap Z order on layers in the same Destination.
2. Can only swap Z order on layers that are of the same type (2K / DL / 4K).

How to swap Z order

1. Click on **Swap Z order** button to enter in the Swap Z order mode.
2. Click on 1 layer at a time and move it to a different location.

How to access the layer adjustments

Adjustments to layers are performed in the “Adjust” panel:

1. Select the layer from the list
Or,
Select the layer from the preview canvas.
The layer is selected.

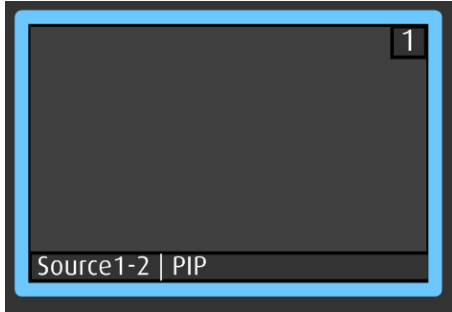

Image 6-71

When the layer is selected and is visible on the canvas, it will have a blue highlight around the layer.

2. Click on the Adjust tab that is on the top of the adjustment area.
The layer adjustment panel is displayed.



It is possible to select multiple layers by clicking on the each targeted layer once Multiple Select is set to ON.

Layer adjustment panel description

The Layer adjustment panel allows access to general layer adjustments and takes effect only if a layer is selected.



Layer adjustments are performed on individual layers. When multiple layers are selected, the adjustments are disabled.

The upper part of the panel is always visible:

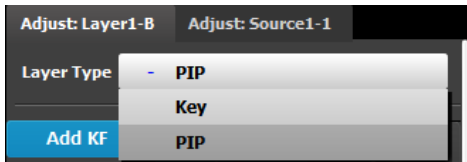

This part includes:

- **Layer type:** Layer can be a PIP or a Key. The available adjustments depend on the selected mode.
- **Keyframes:** There are 2 KeyFrames per layer.

The lower part of the panel provides menus for layer sizing and color adjustments



- Main adjustment : Border and Shadows
- Layer Window adjustment: Size, Position, Mask
- Layer Color Effects adjustment: Brightness, Contrast, Gamma, Hue, Saturation, Monochrome, Invert

PIP / KEY selection

The first selection is the choice for the layer type: PIP or a Key. Depending on the selection, the rest of the menu will adapt.

Keyframes

In a PIP “move,” Keyframe is a point where an action or a change occurs. For example, a PIP movement is described by two keyframes. The first keyframe is the state of the PIP at the initial point of the movement. The second keyframe is the point where the PIP moves to. The size and color attributes can also change during the move.

By default, the initial position and state of the layer is keyframe 1. The user can change the size, and change the border and shadow parameters before defining Keyframe2. After changes are done to Keyframe1, the second keyframe can be added by pressing the “Add KF” button. A new position and size can be defined and adjustments to the border and shadow parameters to define the second Keyframe.

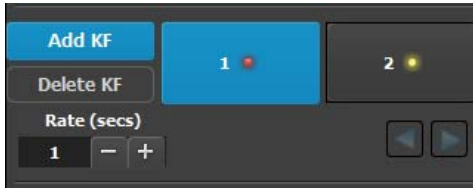

Image 6-72

Once the two keyframes are defined, the PIP can move between the two positions by pressing the green arrow buttons. The rate for the movement is adjusted by changing the number in the corresponding box.

Any of the two keyframes can be deleted when the keyframe is highlighted and by pressing the “Delete KF” button.

The red LED in the keyframe button indicates the current position of the PIP.

Layer adjustment panel > Main adjustment

The Main adjustment panel is variable according the Layer type.

Layer type = PIP (Border Tab):

This menu allows users to adjust the PIP borders.

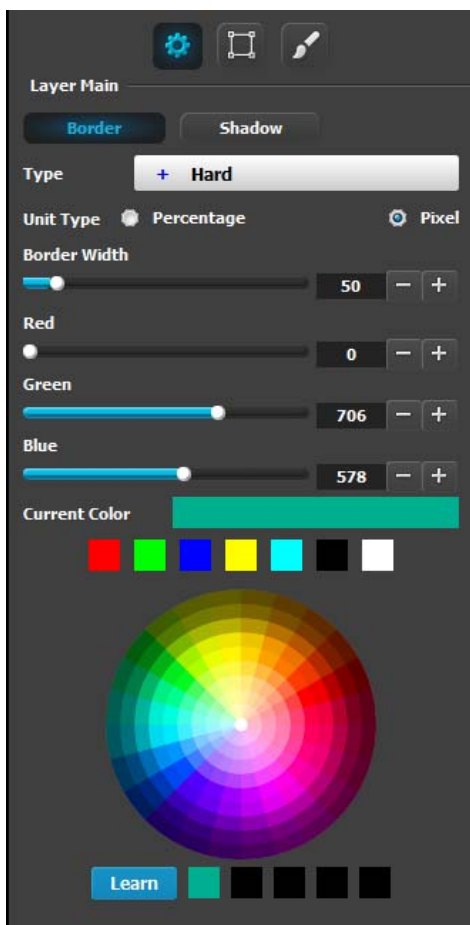

- Borders are enabled by selecting the type of to apply. Six types are available:
 - Hard
 - Soft
 - Halo
 - Halo-in
 - Halo-out
- **Border width** and color are selected by adjusting the corresponding sliders or entering a figure in the adjacent edit boxes. The **border width** can be entered either in Percentage of the vertical size or in pixels.
- The selected color is shown in the **Current Color** bar. The color can also be stored by clicking in one of the square boxes at the bottom of the menu next to the Learn button. These boxes are quick shortcuts to select that color for the Border.
- Another way to specify a color is to click on the **Color wheel**. The slider values will change accordingly as the mouse moves around the color wheel.
- **Learn:** The “Learn” button in the bottom is a way to store custom colors to be used for later. The way to use this area is to:
 - a) Pick a color to save, using color wheel or the R/G/B adjustments.
 - b) Click Learn button.
 - c) Click any one of the buttons on the right.
 - d) The color that was picked is now stored in this button.

Layer type = PIP (Shadow Tab):

The Shadow Menu enables the user to place a shadow behind a PIP.

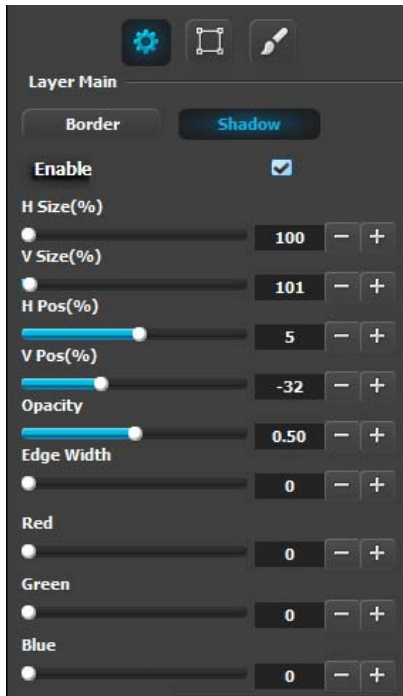

The following functions are provided:

- Enables or disables the PIP's shadow.
- H Size (%): Adjusts the shadow's horizontal size as a percentage of the PIP's size.
- V Size (%): Adjusts the shadow's vertical size as a percentage of the PIP's size.
- H Pos(pixel): Adjusts the shadow's horizontal position in pixels.
- V Pos(pixel): Adjusts the shadow's vertical position in pixels.
- Opacity: Adjusts transparency, from 0 (transparent) to 1024 (opaque).
- Edge Width: Adjusts the width of shadow creating a halo type of an effect.
- Color Selection: Adjusts the shadow's color with the help of the slider, or with the color wheel.

Layer type = Key; Mode = Luma

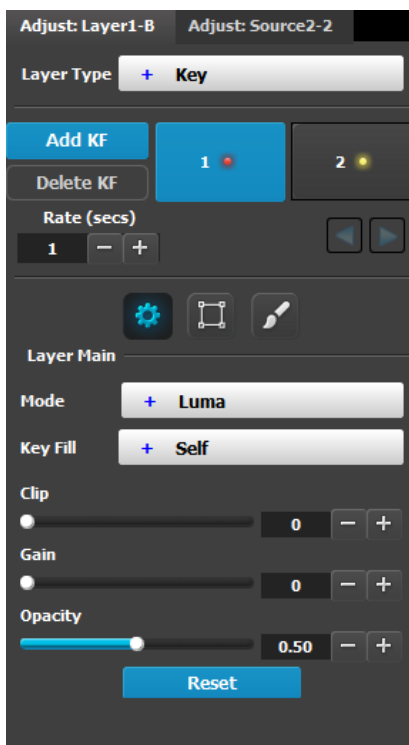

A Luma (Luminance) Key is one in which the hole-cutting information is derived from the luminance (brightness) level of the key source.

Source on the Key Bus can be selected as the "cut." You can select Self or Matte, Preset Bus or Split for the "fill" source.

Clip: Adjust the threshold of the video that "cuts" into the background. A hole is cut into the background anywhere that foreground luminance is greater than the clip level.

- Range: 0.00 to 1.00, in .01 increments
- Default: 50.00

Gain: Adjust the sensitivity of the key, enabling you to change the sharpness of the keyed image. Gain only affects the edge of the key hole, as set by the clip.

- Range: 0.00 to 1.00, in .01 increments
- Default: 1.0

Opacity: Adjusts the opacity of the keyed image, from fully opaque to fully transparent.

- Range: 0.00 to 100.00, in .01 increments
- Default: 100.00

Reset: Press to return all clip, gain and opacity settings to their default values.

Layer type = Key; Mode = Chroma

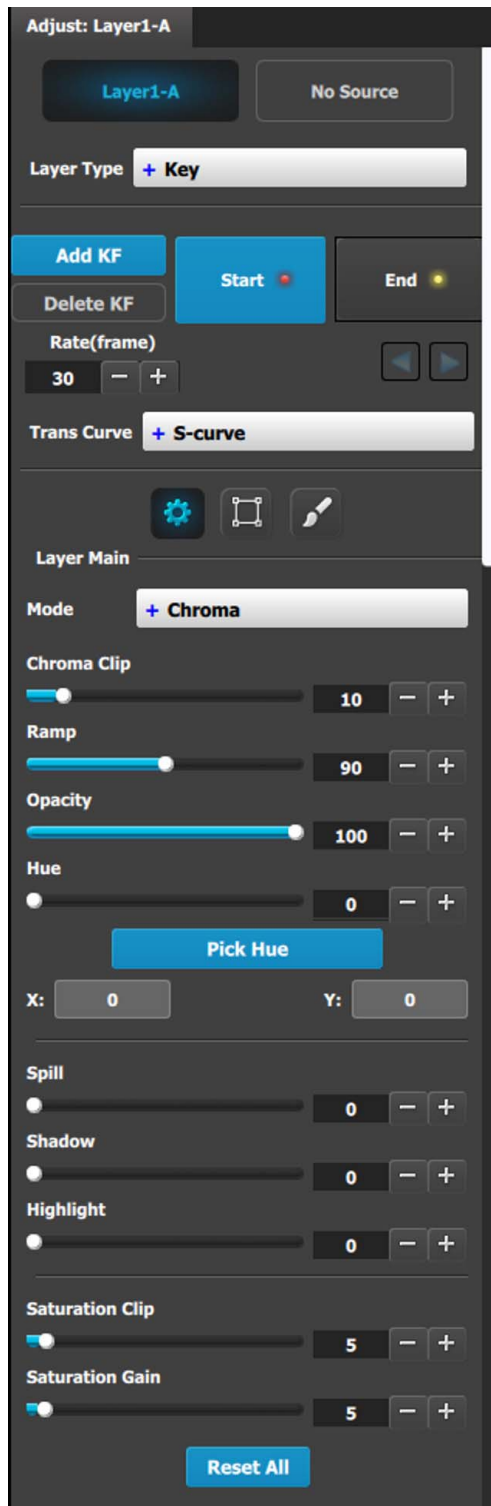

A Chroma (Chrominance) Key is one in which the hole-cutting information is derived from a color in the key source.

After selecting a Hue color to key out, it may be necessary to make additional adjustments to improve the look of the overall compositing effect.

Chroma Clip: This is an angle, centered around the Hue color. Any color inside this angle is fully keyed out.

- Range: 0 to 100
- Default: 10

Ramp: This is an angle, also centered around the Hue color. It must be equal to or larger than the Chroma Clip angle. Inside the Chroma Ramp angle, the colors keyed out ramp linearly the closer the foreground color approaches the Chroma Clip angle. Outside the Chroma Ramp angle, the foreground colors are not suppressed.

- Range: 0 to 100
- Default: 90

Opacity: This allows the key source to become increasingly transparent with respect to the background source.

- Range: 0 to 100
- Default: 100

Hue: This field selects the color to be removed or keyed out of the input. While this can be manually adjusted, the "PICK HUE" feature also changes this number.

- Range: 0 to 100
- Default: 0

Spill: Spill removes unwanted "key" color, which is generally a result of reflection from the (green or blue screen) background, on the foreground object.

- Range: 0 to 100
- Default: 0

Shadow: This allows shadows to be preserved or removed in the foreground image (opposite of Highlight).

- Range: 0 to 100
- Default: 0

Highlight: This allows highlights to be preserved or removed in the foreground image (opposite of Shadow).

- Range: 0 to 100
- Default: 0

Saturation Clip: This defines the threshold along the Saturation axis where keying begins.

Below the clip threshold, the colors are not keyed out. Above the clip threshold, the colors follow the results of Chroma Clip and Gain, but they depend on the Saturation Gain setting as this creates a linear key color strength ramp in the key area.

- Range: 0 to 100
- Default: 5

Saturation Gain: This defines the transition along the saturation axis between keying off and keying on.

- Range: 0 to 100
- Default: 5

Reset: Press to return all clip, gain and opacity settings to their default values.

Pick Hue

The Pick Hue button allows the user to pick and apply a selected hue from any single Layer.

1. Click on the **Pick Hue** button.
Clicking on the Pick Hue button for a Layer places a crosshair on the Layer in Preview in the Programming Diagram area.

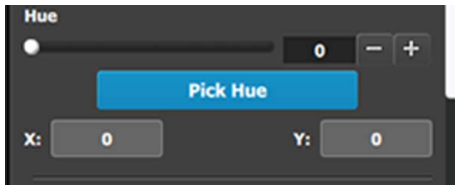

Image 6-73
The Pick Hue button

2. Move the crosshair to the desired hue.
The user can move the crosshair using either the cursor or the X and Y edit boxes.



Image 6-74
Crosshairs

3. Complete the operation by clicking on the **Apply Hue X/Y** button, or cancel the operation by clicking on the Cancel Pick Hue button.

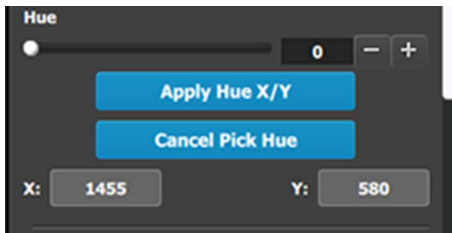
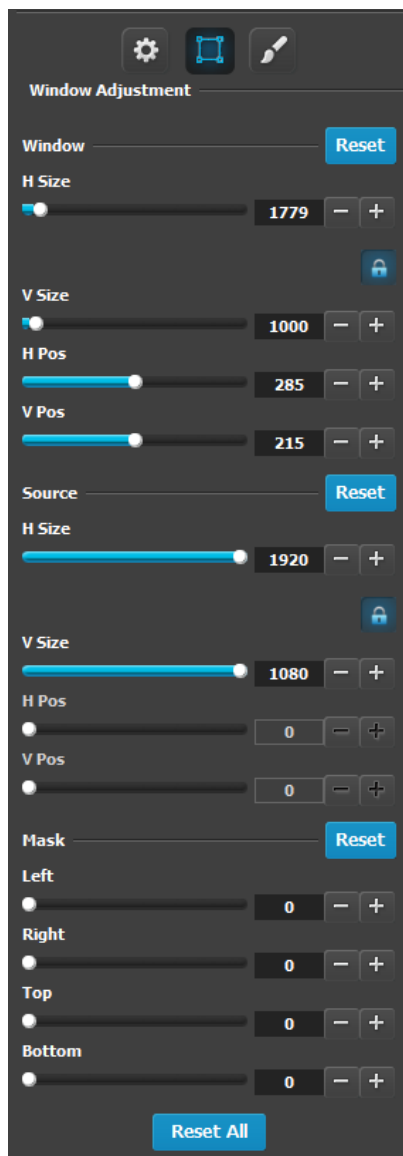

Image 6-75
Apply Hue or Cancel

Layer adjustment panel > Layer Window adjustment



The following PIP Adjustment Menu functions are provided: (All figures are in pixels)

- H Size — adjusts the PIP's horizontal size.
- V Size — adjusts the PIP's vertical size.
- H Position — indicates the PIP's position, relative to the horizontal center of the screen (00), as measured from the exact center of the PIP. Thus, the value -34 is 34 pixels to the left of center.
- V Position — indicates the PIP's position, relative to the vertical center of the screen (00), as measured from the exact center of the PIP. Thus, the value 70 is 70 pixels above center.
- Mask: The Mask Panel enables you to mask (crop) the top, bottom, left, and right edges of the PIP or key.
- Reset All : Press to return all numbers to their default values.

Layer adjustment panel > Layer Effects adjustment

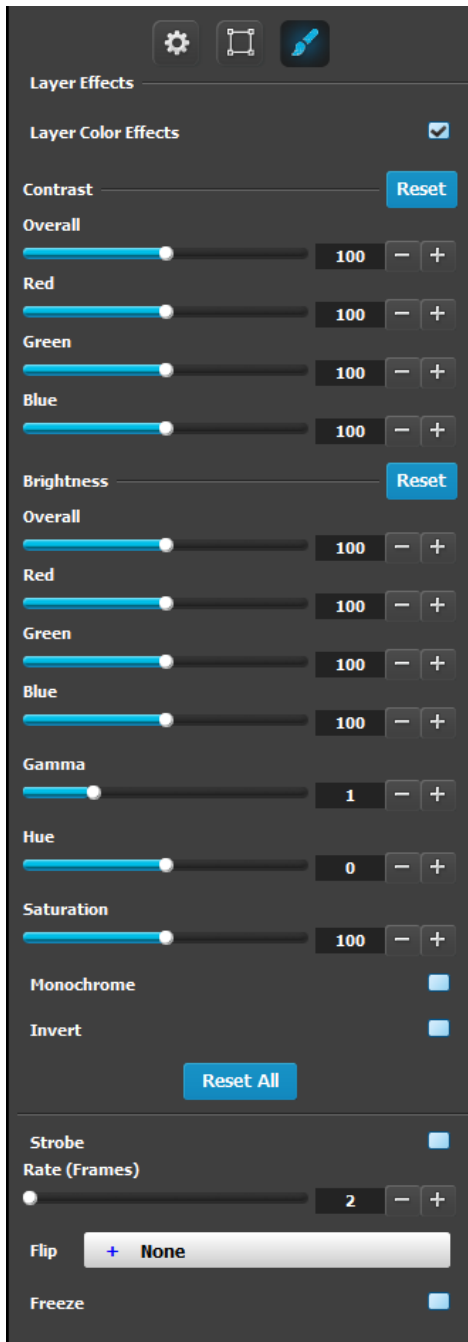

- RGB Contrast and Brightness settings are adjustable within a range of 0% to 200%. The default setting for all of these properties is 100%.
- Gamma is adjustable within a range of 0.3 to 3.28. The default setting is 1.0.
- Hue is adjustable within a range of -180 to +180 degrees. The default setting is 0 degrees.
- Gamma is adjustable within a range of 0.3 to 3.28. The default setting is 1.0.
- Saturation is adjustable within a range of 0% to 200%. The default setting is 0%.
- Monochrome: Toggle this button to turn the source video's chroma component on and off. When off, the image is completely monochrome;
- Invert: Toggle this button to turn the color "invert" function on and off. When on, all image colors are inverted.
- Reset All: Returns all values to their default settings.
- Strobe: Toggles the strobe function on and off. When On, adjust the strobe Rate interval (in frames) to set the duration that the source is frozen until the next grab.
- Flip: Flips the image within the PIP:
 - Off: The image is displayed in its original orientation.
 - H: to flip the image horizontally, along the Y axis.
 - V: Flips the image vertically, along the X axis.
 - H/V: Flip the image both horizontally and vertically, along the X and Y axes.
- Freeze: Enables or disables the freeze action.

Note that almost all color correction effects (except "invert") work on a keyframe by keyframe basis. This enables you to morph effects from keyframe to Keyframe.

6.24 Programming Menu > Adjustment area > Dest Group configuration

General

In the Layer menu, users can manage the destination groups and update their attributes.

Dest Group configuration menu description

The destination group configuration menu is accessed by clicking on the Dest Group tab.

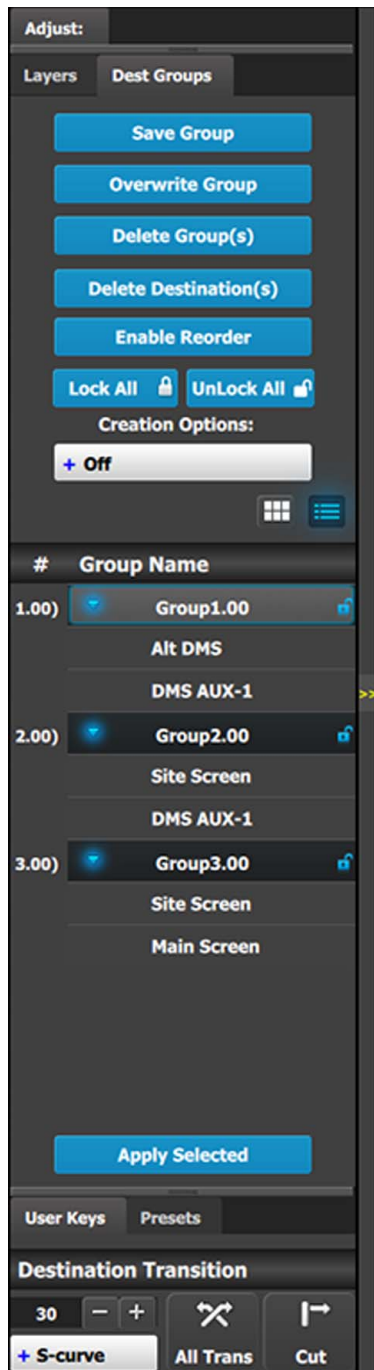

This menu provides:

- A numbered list of the available Destination Groups.
- A **Save Group** button to save new Destination Groups. When a Super Destination is saved as a part of a Destination Group, all Screen Destinations that are assigned to that Super Destination become part of the Destination Group.
- An **Overwrite Group** button to overwrite the data in the selected Group.
- A **Delete Group(s)** button to delete one or more Groups.
- A **Delete Destination(s)** button to delete individual Destinations.
- An **Enable Reorder** button to enable the reordering of Destination Groups in the list.
- A **Lock All** button to lock all the Destination Groups in the list.
- An **UnLock All** button to unlock all the Destination Groups in the list.
- **Creation Options** to use while creating Destination Groups.
 - **Off**: No creation options are chosen. (This is the default option.)
 - **AutoLock**: All Destination Groups created with the AutoLock option On are created in the locked state.
 - **Rename**: All Destination Groups created with the Rename option On are created with the group name highlighted, so that the Group may be immediately renamed.
 - **Rename-Lock**: This is a combination of the Rename and AutoLock options. All Destination Groups created with the Rename-Lock option On are created with the group name highlighted, so that the Group may be immediately renamed, and they are created in the locked state.
- An **Apply Selected** button to recall the selected group.

Save Group

1. Go to the Programming Diagram area and select the Destinations that you want to put in a Destination Group.
2. Go to the Adjustment area and click the **Save Group** button.
The Destinations in a Destination Group are shown in image 6-76.

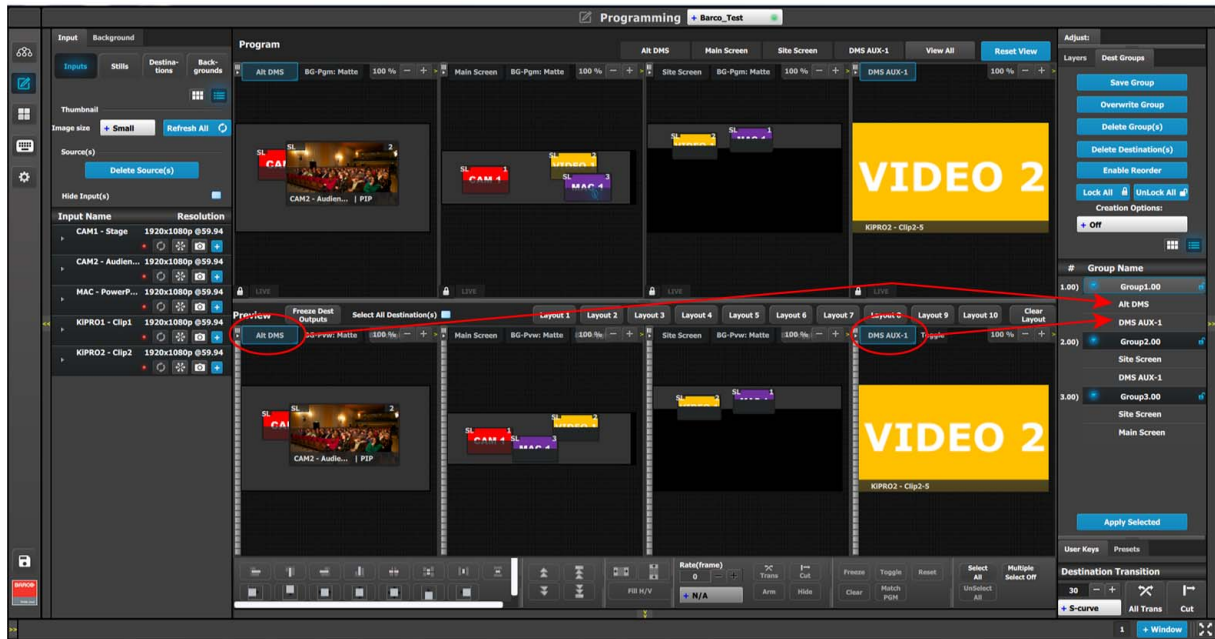

Image 6-76
Destinations in a Dest Group

Overwrite Group

This **Overwrite Group** button is enabled if a Destination Group is selected. Pressing this button overwrites the Group data in the selected Destination Group, but the name of the Group is not updated.

1. Select the Destination Group to be overwritten.
2. Go to the System Diagram area, and select the Destinations with which you want to overwrite the existing Group data.
3. Click on the **Overwrite Group** Overwrite Group button.

Delete Group(s)

Selecting the **Delete Group(s)** button places an **x** next to the name of each Group in the Group Name list.

1. Select the **Delete Group(s)** button.
2. Select the **x** next to the name of each Group in the Group Name list that you wish to delete.
3. Click on the red **Delete Selected** button.

Delete Destination(s)

Selecting the **Delete Destination(s)** button places an **x** next to the name of each Destination in the Group Name list.

1. Select the **Delete Destination(s)** button.
2. Select the **x** next to the name of each Destination in the Group Name list that you wish to delete.
3. Click on the red **Delete Selected** button.

Enable Reorder

This button enables the reordering of the Destination Groups in the list.

1. Select the **Enable Reorder** button.
The text of the button changes to "Disable Reorder."
2. Drag and drop any Destination Group to the place where you want to move it in the list.
3. Click on the **Disable Reorder** button after all the reordering is done.

Apply Selected

1. Select the Group to be recalled from the Group Name list.
2. Click the **Apply Selected** button to recall the group.
The user can also recall a Dest Group by dragging and dropping it into the Workspace/Programming Diagram area.
The Resources area of the Controller Menu has a Groups tab. Groups can be dragged and dropped from the Resources area to the System Diagram area and then be recalled from the controller.

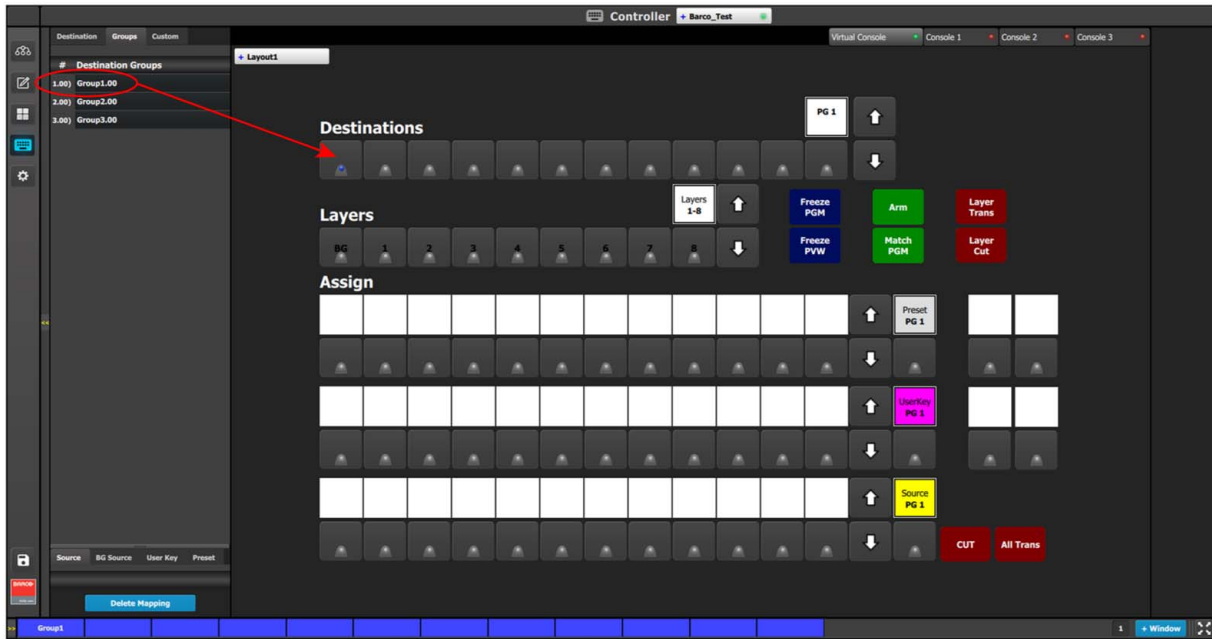

Image 6-77
Destination Groups on the Controller menu

Note: In the Programming menu, selecting a Destination Group deselects any previously selected destinations or groups. Holding the Ctrl key and selecting a Destination Group adds the new group to any previously selected destinations or groups. On the EC-200 Controller, pressing a Destination Group button deselects any previously selected destinations or groups. Holding the Barco Eye key and pressing a Destination Group button adds the new group to any previously selected destinations or groups.

6.25 Programming Menu > Adjustment area > Background configuration

General

In the Layer menu, users can also manage the backgrounds. Two background channels are provided per destination (BG A and BG B), each of which appears at the system's lowest priority — visually in back or underneath all other layers.

Layer/Background configuration menu description

Background adjustments are done in the Layer configuration menu. Layer configuration menu is accessed by clicking on the Layer tab.

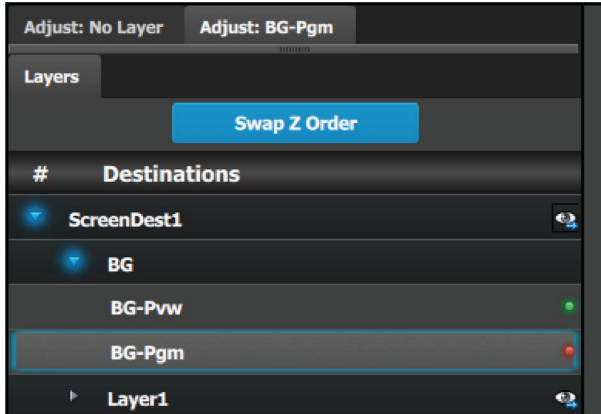

Image 6-78

How to access to the Background adjustments

Adjustments to Backgrounds are performed in the "Adjust" panel:

1. Select the background from the list in the layer panel
Or,
Select the background from the preview windows.

The layer is selected.

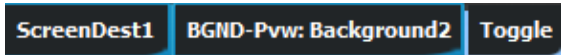

Image 6-79

The background button will have a blue highlight when selected.

2. Click on the Adjust tab that is on the top of the adjustment area.

The background adjustment panel is displayed.

Background adjustment panel description

Background can either be an input, still or matte.

Background input adjustment:

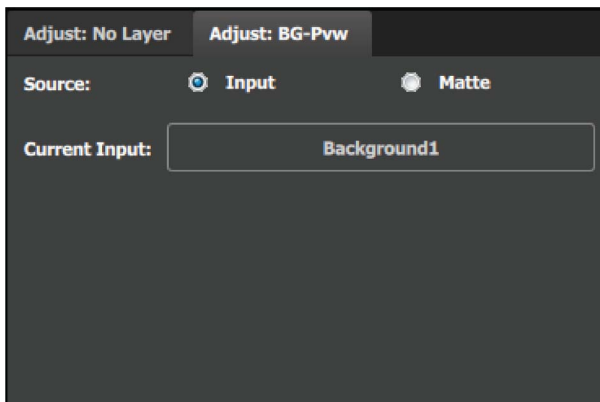

Background matte adjustment:

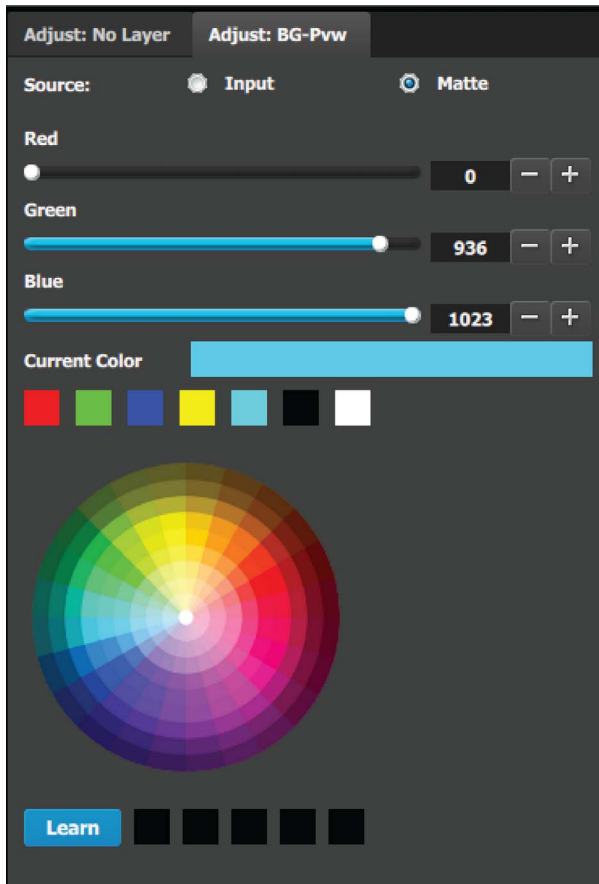

The Standard color wheel selection is available for the Background Matte too

- Background color can be adjusted by updating the Red / Green / Blue slider or edit box. The selected color is shown in the Current Color row.
- The square buttons on the bottom of **Current Color** are quick shortcuts to primary colors. Click on any one of them to select that color for the Background.
- The Color wheel is another way to specify the color. The user can press and hold the mouse when the mouse is on the color wheel.
- **Learn:** The “Learn” button in the bottom is a way to store custom colors to be used for later. The way to use this area is to:
 - a) Pick a color to save, using color wheel or the R/G/B adjustments.
 - b) Click Learn button.
 - c) Click any one of the buttons on the right.
 - d) The color that was picked is now stored in this button.

6.26 Programming Menu > Adjustment area > User Keys configuration

General

The User Key feature enables you to select all (or a portion) of the current layer's attributes (such as border color, size, effects, etc.), and store them on a User Key.

These attributes can then be applied to any active layer on Preview via the Apply Selected button or via Drag and Drop.

User Keys configuration menu description

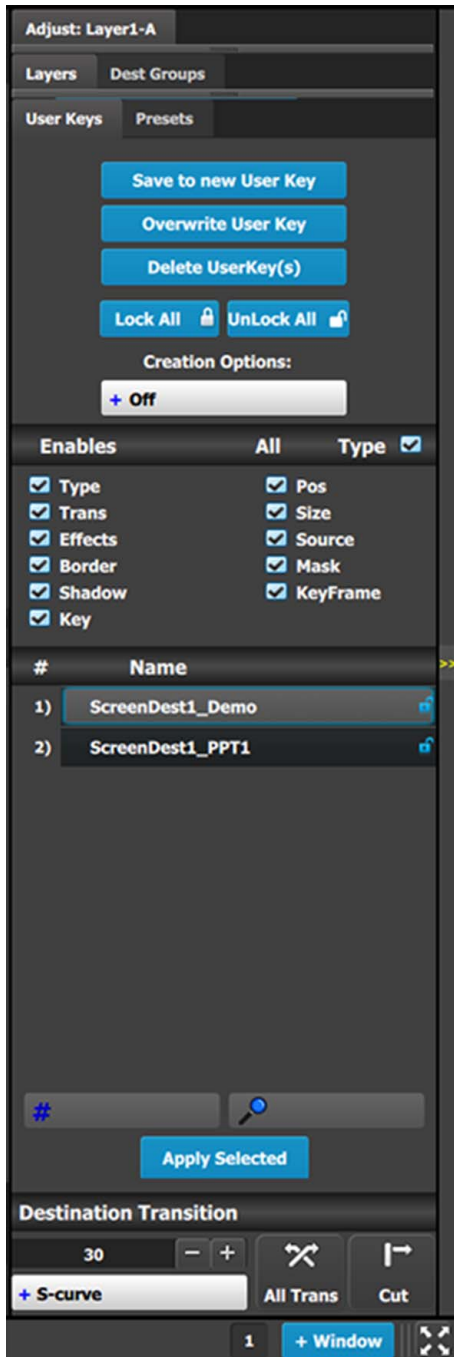

This menu provides:

- A numbered list of the available User Keys.
- A button to **Save** the attributes of a Layer as a new User Key.
- A button to **Overwrite** the Layer data in the selected User Key.
- A button to **Delete** one or more User keys.
- A button to **Lock All** the User Keys in the list.
- A button to **Unlock All** the User Keys in the list.
- Several attributes that can be enabled for use during **Save** operation.
 - **Type**: type of Layer—PIP or Key
 - **Trans**: type of transition
 - **Effects**: color and effects
 - **Border**: On / Off and its parameters
 - **Shadow**: On / Off and its parameters
 - **Key**: Key parameters separated from Layer type
 - **Pos**: Position of Layer
 - **Size**: Size of Layer
 - **Source**: actual size of the Source inside the PIP, as opposed to the Source file
 - **Mask**: Masking parameters
 - **Keyframe**: If checked, information for both Keyframes in the Layer is stored. If unchecked, information from only the active Keyframe in the Layer is stored.
- A search edit box for searching User Keys by number and a search edit box for searching User Keys by name.

Save to new User key

1. Select the layer whose parameters you want to store.
2. Using the menu, enable or disable the specific parameters that you wish to store (e.g., Type, Trans, Effects, Key etc.). You can also enable all parameters using the ALL button.
3. Select the "Save to new User Key" button.
4. The User Key appears in the list.
5. Repeat from step 1 to store additional User Keys.

Overwrite User key

This button is enabled if a layer and a user key is selected. Pressing this button overwrites the layer data in the selected user key but the name of the user key is not updated. The attributes saved are based on the selection of the Enables boxes. If no boxes are checked, no user key is created.

Delete User Key(s)

Allows for multiple deletes of User keys.

1. Click the **Delete UserKey(s)** button.
2. Select the User Key to be deleted by clicking the **X** next to the lock for that User Key.

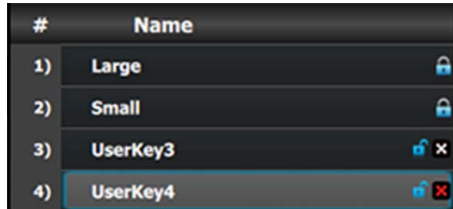

Image 6-80
Select a User Key

Note: If a User Key is locked, it cannot be deleted.

3. Select **Delete Selected** to delete only the selected User Key(s), or select **Select All** then select **Delete Selected** to delete all User Keys.

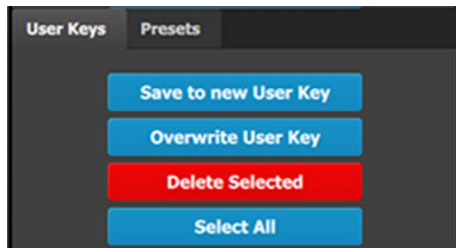

Image 6-81
Delete Selected User Keys

User key list

Lists alphabetically all User Keys.

Search edit box

Search User keys by name. A list of User Keys including the selection appears instead of the full list.

Search Number (# icon)

Entering a number between 1 and 999 will searches for, selects, and shows that number User Key.

Apply Selected

The selected User Key is applied to the selected layer(s) on Preview and on Program if "Modify on Program is enabled".

Renaming User Keys

Change the name of a User Key by double-left-clicking on the name itself. The list is not reordered based on the new name.

Renumbering User Keys

Edit the number of a User Key by double-left-clicking on the number. The list is reordered based on the new number.

6.27 Programming Menu > Adjustment area > Presets configuration

General

The Preset is a register that enables you to store destination setups, “looks,” to memory, and to recall them.

Presets configuration menu description

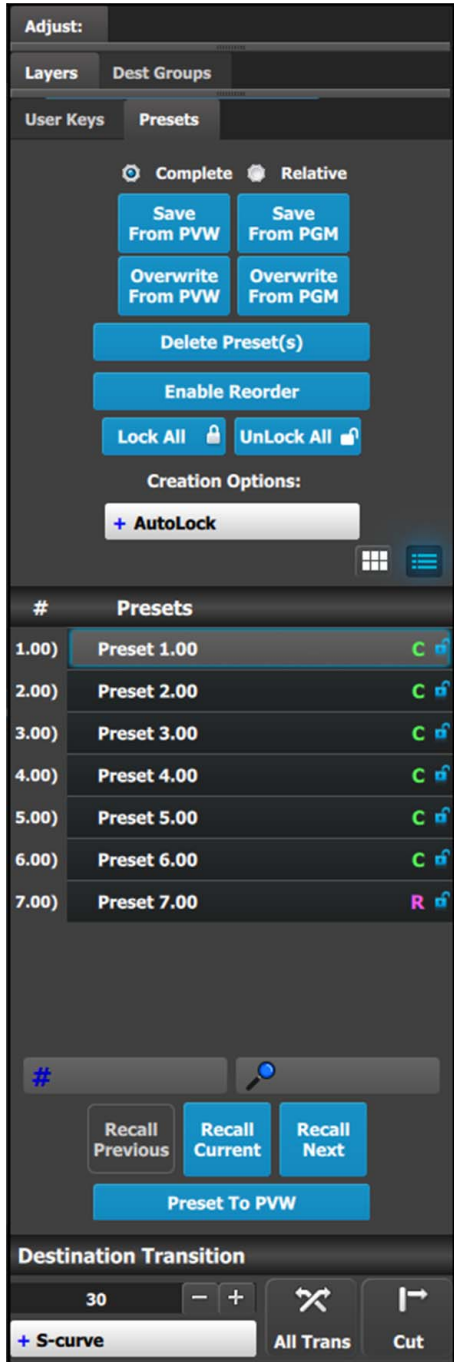

This menu provides:

- A numbered list of the available Presets.
- Buttons to select the complete or relative saving of Presets.
- A **Save from PVW** button to create a new Preset from selected Destination(s) in Preview.
- An **Overwrite from PVW** button to overwrite the preset data in the selected Preset from selected Destination(s) in Preview.
- A **Save from PGM** button to create new Preset from the selected Destination(s) in Program.
- An **Overwrite from PGM** button to overwrite the preset data in the selected Preset from selected Destination(s) in Program.
- A **Delete Preset(s)** button to enter a multiple delete of Presets.
- An **Enable Reorder** button to enable the reordering of Presets in the list.
- A **Lock All** button to lock all the Presets in the list.
- An **Unlock All** button to unlock all the Presets in the list.
- A couple of search edit boxes to search Presets.
- Three buttons to manage Preset recall actions.

Complete vs Relative

The “Complete” and “Relative” radio buttons do not affect the recall process; they are used only during the save process.

- To save a “Complete” preset, make sure the “Complete” radio button is selected, arm the Destinations to be part of the Preset and press the “Save from PVW” or “Save from PGM” button. A “Complete” Preset is marked with a “C” in the Presets list.
- To save a “Relative” preset, make sure the “Relative” radio button is selected, arm the Destinations to be part of the Preset, hide/show the Background/Layers in the destinations and then press the “Save from PVW” or “Save from PGM” button. A “Relative” Preset is marked with an “R” in the Presets list.

When a “Complete” Preset is recalled, all Layers of the chosen Destinations are affected. When a “Relative” Preset is recalled, normal layers are affected, but hidden Layers are not affected.

To hide a Layer, select the Layer in the Programming Diagram area of the Workspace, then select Hide in the System Wide function are of the workspace. See image 6-82.

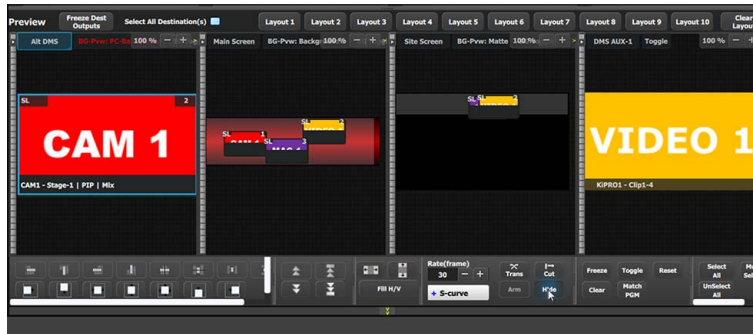

Image 6-82
Hiding a Layer

A Layer can also be hidden using the Hide icon in the Programming > Adjust > Layer configuration menu. See "Programming Menu > Adjustment area > Layer configuration", page 195.

A hidden Layer shows a “hidden” symbol in the lower right-hand corner of the Layer. See image 6-83.



Image 6-83
Hidden Layer with “hidden” symbol

Save From PVW

Saves the current look on Preview into a new Preset. Only Destinations that are active or selected will be saved. For example: There are 3 Destinations. User enables Dest1 and Dest 3 and presses “Save to new Preset.” Only Dest1 and Dest3 looks are stored. Dest 2 is not part of this Preset.

Save From PGM

Saves the current look on PROGRAM into a new Preset. Only Destinations that are active or selected will be saved. For example: There are 3 Destinations. User enables Dest1 and Dest 3 and presses “Save to new Preset.” Only Dest1 and Dest3 looks are stored. Dest 2 is not part of this Preset.

Overwrite From PVW

This button allows the override of a selected Preset from the Preview, if the destination is active. The name of the preset is not updated.

Overwrite From PGM

This button allows the override of a selected Preset from the Program, if the destination is active. The name of the preset is not updated.

Delete Preset(s)

By pressing this button, the delete “x” marks will appear next to all presets. Select the presets you like to delete and then press the red “Delete Selected” button.

Search edit box

Search Presets by characters in names. A list of the preset with be singled out. List restores to normal once search box is cleared.

Search Number (# icon)

Search Preset by number, User types the number of the preset wanted and this preset will be instantly selected ready for recall.

Recall buttons

They are not enabled unless a Preset is selected from the list.

1. Recall Previous button: Recalls the Previous preset. Not active is the Preset1 is selected.
2. Recall Selected button: Recalls the currently selected Preset.
3. Recall Next: Recalls the next preset. Not active the last preset in the list is selected.

Preset To PVW / Preset To PGM

Pressing this button toggles between recalling Presets to Preview (see image 6-84) or directly to Program (see image 6-85). The functions of recall buttons are the same in either case, but Presets recalled to Program automatically transition to Program as soon as they are ready to go. This also applies to dragged and dropped presets.

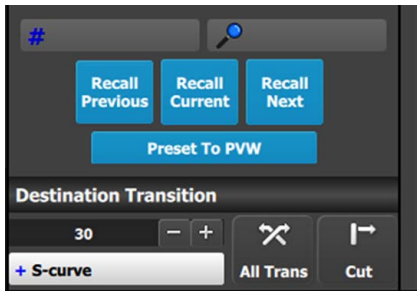

Image 6-84
Preset to PVW

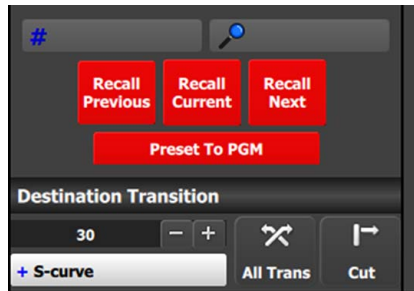

Image 6-85
Preset to PGM

6.28 Programming Menu > Adjustment area > Source adjustment

General

The Source adjustments are shown on the Adjust panel when a layer with a valid Source is selected. The Source adjustment controls does not appear when you select the Source by itself. Also note that the adjustments made here are made on the layer's copy of the Source, not the actual Source itself. The actual Source is updated only when the "Save Source" is pressed.

Description

When a layer with a valid Source is selected, 2 adjustment tabs are shown. It defaults to showing the layer adjustments. But the user can click on the Source adjustment tab to see the adjustments mentioned in this section.

Two Tabs for Source adjustment:

- Main adjustment : Size, position, Aspect ratio, and Bind to User Key.
- Color adjustment: Contrast, Brightness, Gamma, Hue and Saturation

Main adjustment

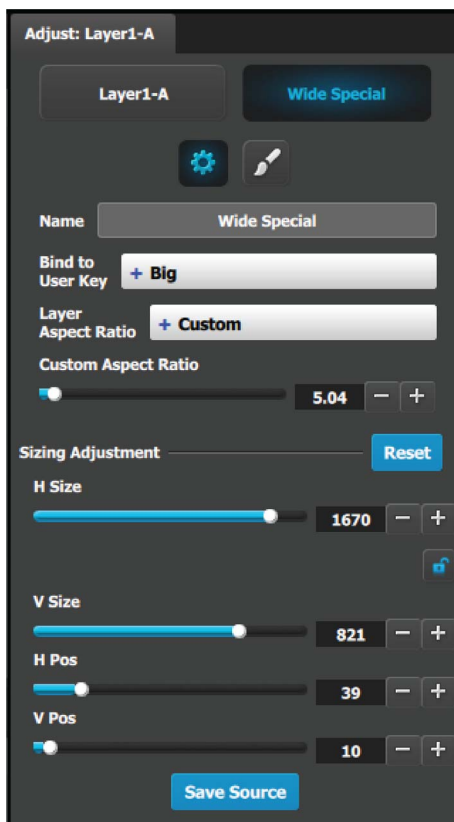

The following Source Adjustment Menu functions are provided:
(All figures are in pixels)

- H Size: adjusts the source's horizontal size.
- V Size: adjusts the source's vertical size.
- H Position: adjusts the source's horizontal position.
- V Position adjusts the source's vertical position.
- Save Source would save the Source information from the selected layer to the actual Source

Note that the "Custom aspect ratio" is disabled unless the "Default Layer Aspect Ratio" is set to Custom.

Color adjustment



- RGB Contrast and Brightness settings are adjustable within a range of 0% to 200%. The default setting for all of these properties is 100%.
- Gamma is adjustable within a range of 0.3 to 3.28. The default setting is 1.0.
- Hue is adjustable within a range of -180 to +180 degrees. The default setting is 0 degrees.
- Saturation is adjustable within a range of 0% to 200%. The default setting is 0%.
- Reset All: Returns all values to their default settings.
- Save Source would save the Source information from the selected layer to the actual Source.

6.29 Programming Menu > Adjustment area > Global Transition Rate/Trans/Cut

General

At the bottom of the adjustment panel, is the transition rate and type buttons. These actions are executed for the selected Destinations.

Description

These controls are disabled if no Destination is selected.



Image 6-86

All Trans button

This button transitions the Preview into Program according to the transition rate. The transition Rate is transition rate in frames of the native rate.

Four transition types are available: Linear, S-Curve, Logarithmic and Exponential.

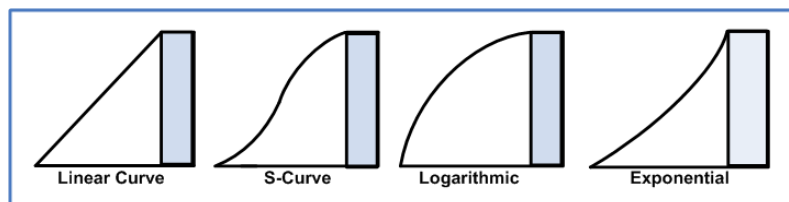

Image 6-87

CUT button

Pressing the CUT button immediately presents the Preview to the Program.

6.30 Multiviewer (MVR) Menu

General

The last card slot on an Event Master processor—for example, Slot #14 on an E2, or Slot #9 on an S3-4K—may be either a normal Output slot or a dedicated Multiviewer. (See the description of the Setup tab in "Configuration Menu > Adjustment > Unit Configuration", page 115 for instructions on how select this slot as either an Output slot or a Multiviewer slot.)

A Multiviewer enables multiple sources (inputs, Backgrounds, outputs) to be displayed on one or two monitors. Screen Destinations (Program and Preview) can be used up to two times in any Multiviewer Output. The position of the window for each copy can be different, but the size of the window for each copy is always the same." **Multiviewer Menu** is the module used to setup the Multiviewer outputs.

Description

 This menu is accessible by clicking the Multiviewer icon in the menu bar on the left side of the UI.

The three drop-down menus in the title bar select the system, unit or layout displayed in the multiviewer. For release one, only one system and one unit are supported.

The Multiviewer page is divided in four parts.

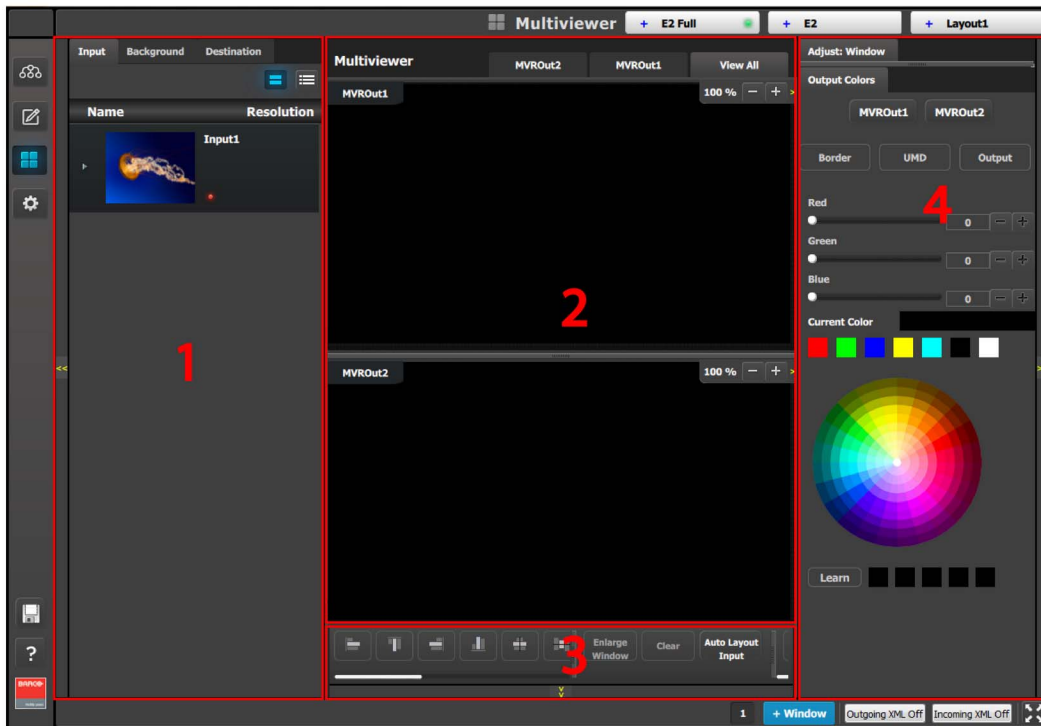

Image 6-88

1	Resources area	Lists the resources available to be displayed in the Multiviewer: Inputs, Backgrounds and Program/Preview Destination Outputs.
2	Multiviewer Layout area	The two multiviewer outputs are composed, viewed and managed individually or as a group.
3	Modifier area	Alignment adjustments and controls to manage the multiviewer outputs
4	Adjustment area	Color and sizing adjustments for the windows in each PIP.

The following sections describe each part of the Multiviewer page in detail:

- "Multiviewer Menu > Resource area", page 217
- "Multiviewer Menu > Multiviewer Layout area", page 218
- "Multiviewer Menu > Modifier area", page 220
- "Multiviewer Menu > Adjustment area", page 221

6.31 Multiviewer Menu > Resource area

General

This part of the **Multiviewer Menu** provides a list of all the resources that are available to be displayed in the Multiviewer.

Description

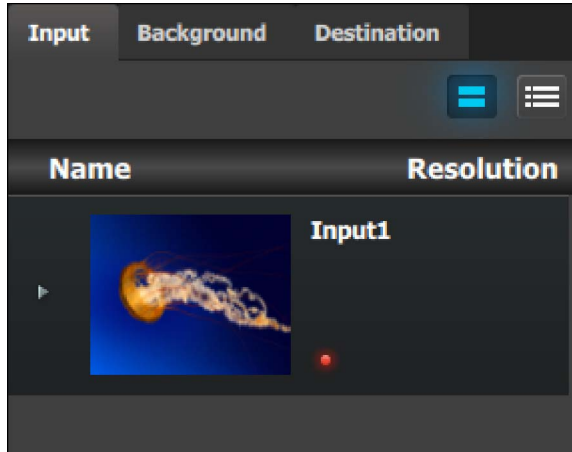

Image 6-89

There are 3 tabs in this section:

- **Input:** Lists the inputs as defined in the System Configuration menu.
- **Background:** Lists the backgrounds as defined in the System Configuration menu.
- **Destination:** Lists the destinations as defined in the System Configuration menu. AUX Preview is not a valid Multiviewer source.

How to add a resource to the Multiviewer

Resources are placed in the Multiviewer layout area by dragging them as it is done with the sources in the programming menu. When a resource is dropped in the Multiviewer a window appears in that location. A window cannot overlap another window, so if the resource is dropped at a location of another window the new resource will be ignored.

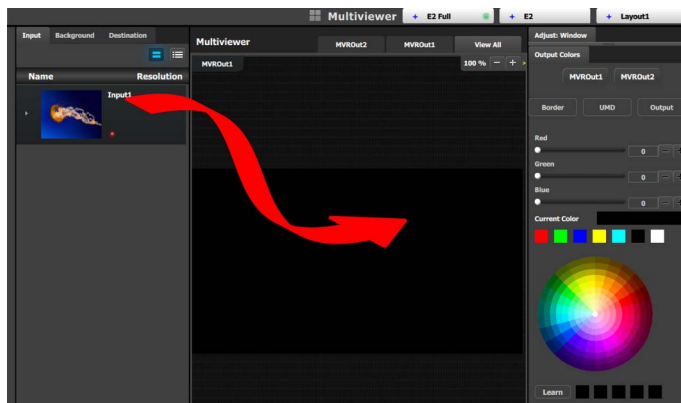

Image 6-90



Screen Destinations (Program and Preview) can be used up to two times in any Multiviewer Output. The position of the window for each copy can be different, but the size of the window for each copy is always be the same."



If inputs, backgrounds or destinations are deleted after they are placed in the MVR, they will also automatically deleted from the MVR.

6.32 Multiviewer Menu > Multiviewer Layout area

General

This part of the **Multiviewer Menu** allows a user to add and position sources in Multiviewer outputs.

Description

The tabs on the top of the layout panel area allow the user to view the two outputs together or individually.

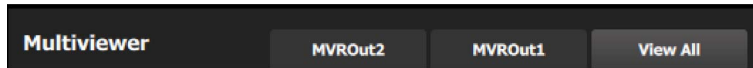

Image 6-91

Users can zoom in / out each output individually, in from 25% to 150%, in 25% increments.



Image 6-92

Multiviewer windows, also called Image windows, are composed from inputs, backgrounds and destination sources. There are 3 elements that make up a multiviewer image window: Content area, border and UMD (Under-Screen-Display).



Image 6-93

Content area

The default content display area has 16:9 aspect ratio. If the source dragged to this area has different aspect ratio, it will be adjusted horizontally to fit the space.

If the output format of a source is changed after it is placed in the MVR, the change will not follow in the MVR window. The window will need to be resized manually in the adjustment panel.

UMD

The text tracks the name of the source in the display area. If the resource is renamed, the UMD will also change to the new name. The UMD can be edited in the adjustment panel.

One line of text is provided. The UMD area provides for 16 characters. If the text is too long it will be terminated with "...".

The background color is adjustable; the default color is gray. The UMD color will go red in case sync is lost.

Border

The border width is fixed at 5 pixels. Border color is adjustable with the default color blue. The border will go red in case sync is lost.

6.33 Multiviewer Menu > Modifier area

General

This area is specifically for window adjustments on Multiviewer outputs.

Description

The area is broken up into several sub areas. The left side is for alignment and position of the window. The right is for misc. controls.

Window Alignment controls

The multiviewer alignment icons are similar to the icons in the Programming alignment panel. For more details, please refer to the chapter "Programming Menu > Layer Modifier area", page 190.



Image 6-94

Miscellaneous Control

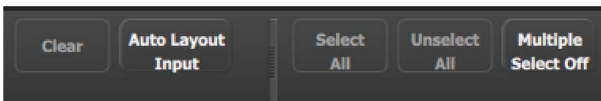

Image 6-95

Clear

Removes the selected window from the multiviewer window.

Auto Layout Input

Clears the multiviewer display and places all selected sources and the background from the list in the multiviewer display in the following arrangement.



Image 6-96

Select All / Unselect All

Selects or unselects all the windows from the multiviewer display while **Multiple Select** is On

Multiple select

Button used to enable or disable multiple selection.

6.34 Multiviewer Menu > Adjustment area

General

Situated on the right hand side of the screen is the Adjustment area. In this area the user can configure the color and sizing of each multiviewer windows.

Description

There are several tabs in this area:

- **Output colors:** Provides 2 tabs (one per multiviewer output) where the user can modify the color attributes of each output.
- **Window adjustment:** Provides sizing and positioning adjustments for the selected window.

The following sections describe each tab of this area in detail:

- "Multiviewer Menu > Adjustment area > Output Color", page 222
- "Multiviewer Menu > Adjustment area > Window adjustment", page 223

6.35 Multiviewer Menu > Adjustment area > Output Color

General

In this section, the user can modify the color attributes (window borders, window UMD, output background) of each multiviewer output.

Description

Each output has its own color adjustments. There are 2 buttons to select the output window that the color adjustments are applied.

There are 3 tabs inside the color panel:

- **Border:** Adjusts the Window border color.
- **UMD Background:** Adjust the image window's UMD background color.
- **Output Background:** Adjust the display background color.

The color controls under the 3 tabs are identical and operate similar as the color adjustments in other menus.



- The selected color is shown in the **Current Color** bar. The color can also be stored by clicking in one of the square boxes at the bottom of the menu next to the Learn button. These boxes are quick shortcuts to select that color.
- Another way to specify a color is to click on the **Color wheel**. The slider values will change accordingly as the mouse moves around the color wheel.
- **Learn:** Provides a method to store custom colors. To learn a new color:
 - a) Pick a color to save by using color wheel or by adjusting the R/G/B.
 - b) Click Learn button.
 - c) Click any one of the five boxes on the right.
 - d) The color that was picked is now stored in selected box.

6.36 Multiviewer Menu > Adjustment area > Window adjustment

General

In this section, the user can resize and position the selected window. A multiple window selection is available.

Description

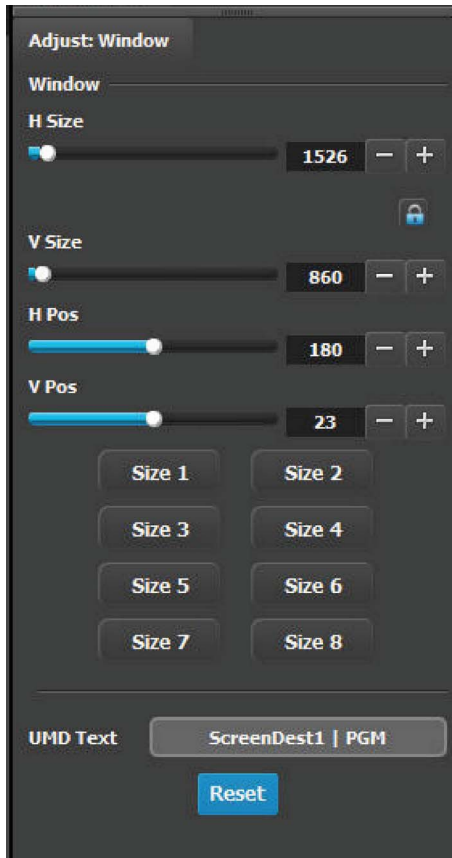

The following functions are provided:

- H Size(pixel): Adjusts the window's horizontal size in pixels.
- V Size(pixel): Adjusts the window's vertical size in pixels.
- H Pos(pixel): Adjusts the window's horizontal position in pixels.
- V Pos(pixel): Adjusts the window's vertical position in pixels.
- Automatic preset: The eight buttons at the bottom are shortcuts to different sizes depending on how many of these windows can fit horizontally. Vertically the window is adjusted to match the aspect ratio.
For example:
 - Size 1: The window is adjusted to fit the full horizontal space.
 - Size 2: The window is adjusted to half the horizontal space.
 - ...
 - Size 8: The window is adjusted to an eighth of the horizontal space.
- Reset button would reset the UMD text to the current name of the Source.

6.37 Controller Menu

General

Event Master processors and devices can be supported by Event Controllers, hardware consoles specifically designed to facilitate and accelerate the operations during the show. **Controller Menu** is the module used to setup the selected console.

Description

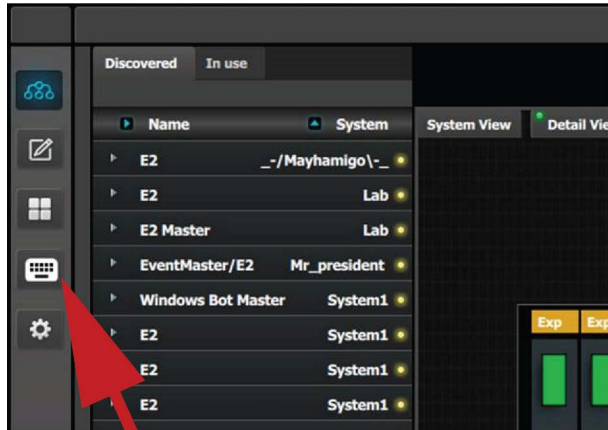

Image 6-97



This menu is accessible by clicking the **Controller** icon in the menu bar on the left side of the UI.

The Controller setup page is divided in two parts. One list of available resources (right side of the page) and one virtual representation of the selected controller.

The user can assign resources from the list onto controller buttons via drag and drop, or remove incorrect mapping.

Refer to the chapter "Assigning resources to the desk ", page 344 for more information about the **Controller Menu** setup page.

6.38 Settings Menu

General

The Settings menu provides access to the Event Master series processor web app that is built into the unit. The app provides users with diagnostic reports, includes an FAQ section and contact information and supports system backup / restore and new firmware installation.

Description



This menu is accessible by clicking the System Settings icon on the menu bar on the left side of the UI. If there are no System / VPs connected in the system, this button is disabled.

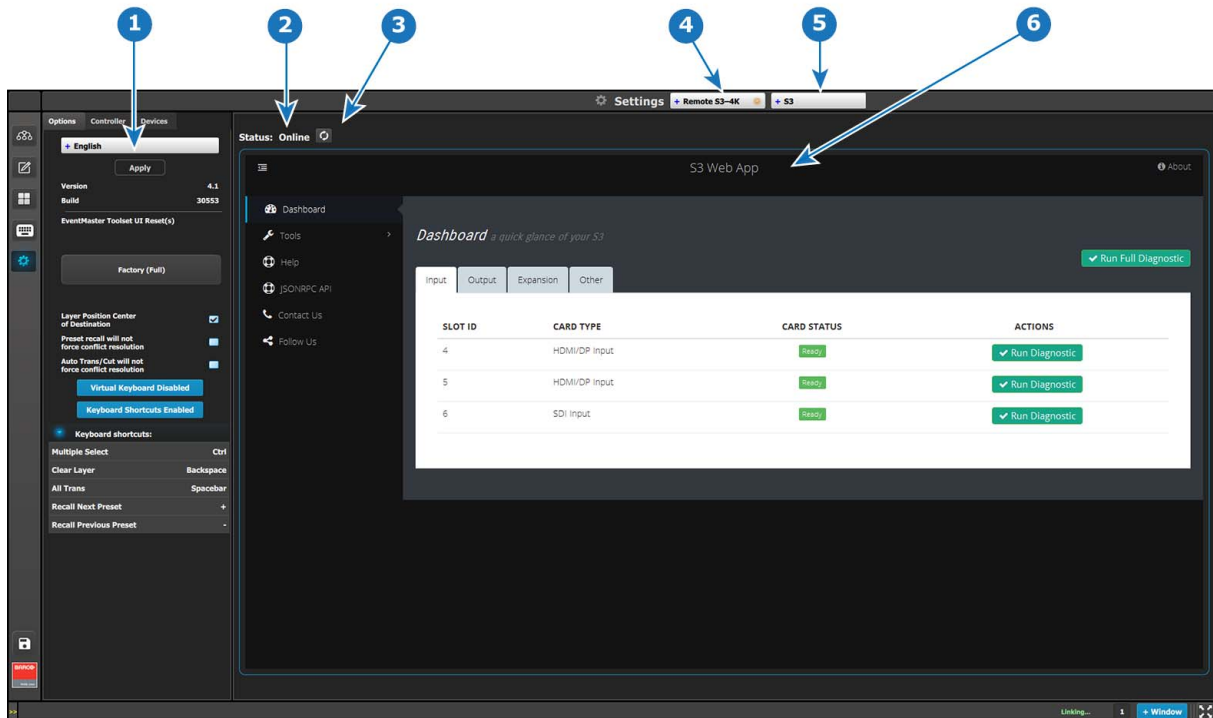

Image 6-98
Settings Menu

1	Resources area	<p>The Resources area contains the Options, Controller, and Devices tabs.</p> <ul style="list-style-type: none"> The Controller tab shows EC-50 / EC-200 settings and is applicable only when an EC-50 / EC-200 controller is connected on the network. The Devices tabs shows what Barco devices (such as projectors) are detected on the network. The Option tab allows the user to choose settings concerning the Event Master Toolset Software. <p>Please see the sections below dedicated to these options.</p>
2	Status	<p>Show status:</p> <ul style="list-style-type: none"> Online: the VP is online and the web application can be reached. Web application error: the VP is online but the web application cannot be displayed. Offline (in red text): the VP is offline.
3	Refresh Web app area button	<p>Similar to web browser, pressing this button will trigger an attempt to refresh / reconnect to the web interface of the selected VP.</p>
4	System select combo box	<p>Informs the users which System is currently being selected. If there is more than 1 System defined in the UI, this combo box can be used to select between the different Systems.</p>

5	Device select combo box	Informs the user which Device is currently being selected in the selected system.
6	Web app area	Main work area where the different menus are displayed.

Description of the Options tab of the Resources area

- **Language:** This parameter allows the user to choose the language of the GUI. **Note:** The only language available in version 1.5 is English.
- Version Number: version number of the Event Master Toolset (read only).
- Build Version: build version of the version of Event Master (read only).
- Event Master Toolset UI Reset(s)—Factory (Full): A Factory (Full) reset deletes all information and returns the UI to factory settings.
- Layer position Center of destination, coordinate for PIP’s positioning PIP: allows the user to choose the default layer position.
 - If selected the position X=0 and Y=0 will be in the center of the destination and Pixel 0 will be in the center of the PIP.
 - If unselected the pixel X=0 and Y=0 will be on top left of the destination and Pixel 0 will be on top left of the PIP.
- Preset recall will not force conflict resolution: When this box is checked, conflict resolutions are not forced when recalling a Preset. A pop-up window appears, requiring user confirmation. The user’s choices are:
 - Resolve—All Trans
 - Resolve—Cut
 - Resolve—Wait
 - Cancel
- Auto Trans/Cut will not force conflict resolution: When this box is checked, conflict resolutions are not forced when either the All Trans button or the Cut button is activated.
- Virtual Keyboard Disabled button: This button enables or disables the virtual keyboard.
- Keyboard Shortcuts enabled/disabled button: This button enables or disables keyboard shortcuts.
- Keyboard shortcuts list: The following keyboard shortcuts are available in the Event Master Toolset software.

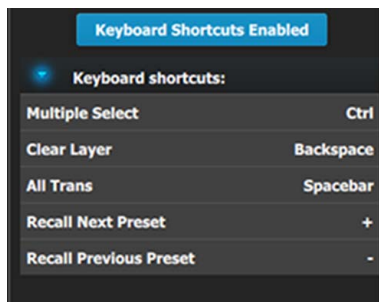

Image 6-99
Keyboard shortcuts

It’s possible to change any shortcut key:

- Double click on the shortcut name (e.g. Multiple Select).
A popup appears near the shortcut name.

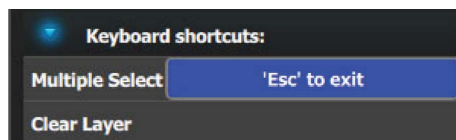

Image 6-100

- Press any key on the keyboard.
This key will affect to the selected shortcut.

Description of the Controller tab of the Resources area

The Controller tab shows EC-50 and EC-200 settings and is applicable only when an EC-50 or an EC-200 controller is connected to the system. The Controller tab has three subtabs: Software, User Pref, and Diagnostic.

Software subtab

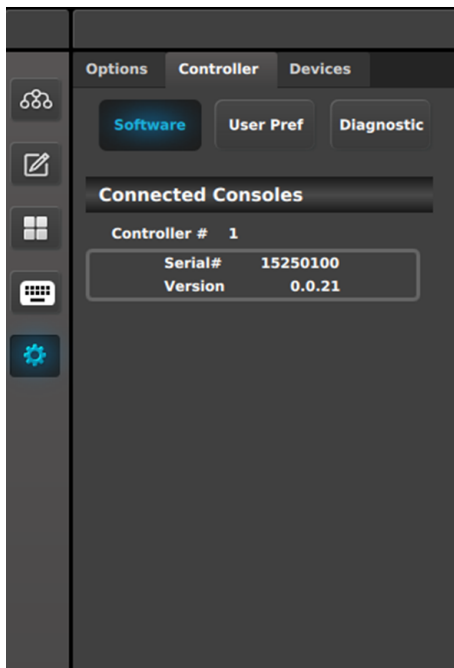

Controller tab: Software subtab

This panel displays the serial number and the software version for each detected controller.

When the Controller > Software subtab is selected in the Resources area, the Web App area shows the EC-200 web app. The user can upgrade the EC-200 software through the EC-200 web app.

User Pref subtab

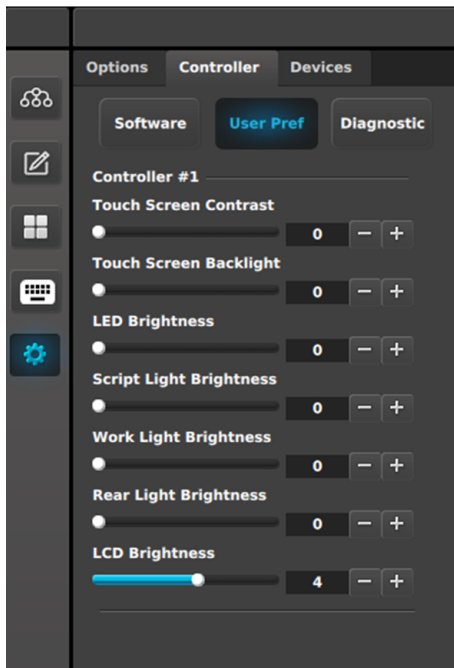

Controller tab: User Pref subtab

This panel displays the user-defined preferences for each detected controller. The user can also adjust the preferences in this panel.

- **Touch Screen Contrast:** Change the contrast of the touch screen displays. Range is 0–100.
- **Touch Screen Backlight:** Change backlight brightness of the touch screen displays. Range is 0–100.
- **LED Brightness:** Change the brightness of the LEDs under the buttons. Range is 0–6000.
- **Script Light Brightness:** Change the brightness of the LED script lights. Range is 0–16000.
- **Work Light Brightness:** Change the brightness of the white LEDs on the front bottom of the controller. Range is 0–16000.
- **Rear Light Brightness:** Change the brightness of the red LEDs on the rear top of the controller. Range is 0–16000.
- **LCD Brightness:** Change the LCD display brightness. Range is 0–7.

Diagnostic subtab

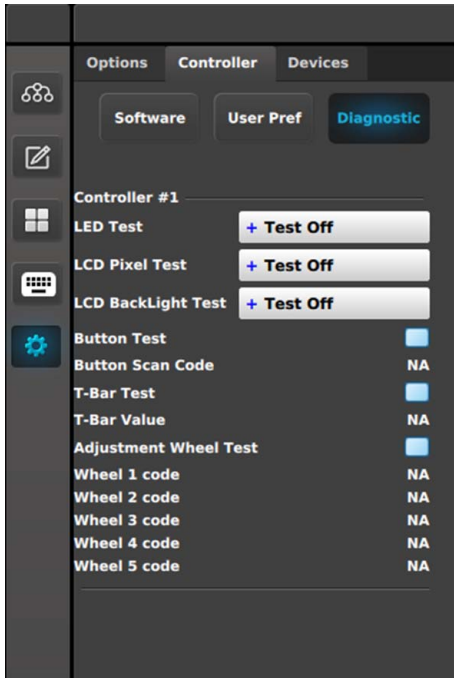

Controller tab: Diagnostic subtab

This panel displays test controls for each detected controller.

- **LED Test:**
 - Test Off: LEDs are returned to normal behavior.
 - All Blue/Red: Turns on all blue and red LEDs; other LEDs are turned off.
 - All Green: Turns on all green LEDs; other LEDs are turned off.
- **LCD Pixel Test:**
 - Test Off: LCD text is returned to normal behavior.
 - All: All LCD displays are filled (all 256 bits are enabled).
- **LCD Backlight Test:**
 - Test Off: LCD colors are returned to normal behavior.
 - Red: Only LCD red color is turned on.
 - Green: Only LCD green color is turned on.
 - Blue: Only LCD blue color is turned on.
 - All: LCD red, green, and blue colors are all turned on.
- **Button Test:**
 - Checkbox checked: The test is on. When the test is on, do not trigger the behavior of the button. For example, if a button is mapped to a Preset, **do not** recall that Preset.
 - Button Scan Code: Pressing a button on the controller shows the button number returned by the API (in place of the "NA").
- **T-Bar Test:**
 - Checkbox checked: The test is on.
 - T-Bar Value: Moving the T-Bar shows the number returned by the API as the T-Bar changes positions.
- **Adjustment Wheel Test:**
 - Checkbox checked: The test is on.
 - When the test is on, rotating the wheel shows the number returned by the API.

Description of the Devices tab of the Resources area

The Devices tab lists devices, such as projectors, that are connected to the system. Devices such as other processors (E2, S3-4K, EX, etc.) are Discovered on the Configuration menu Discovered list.

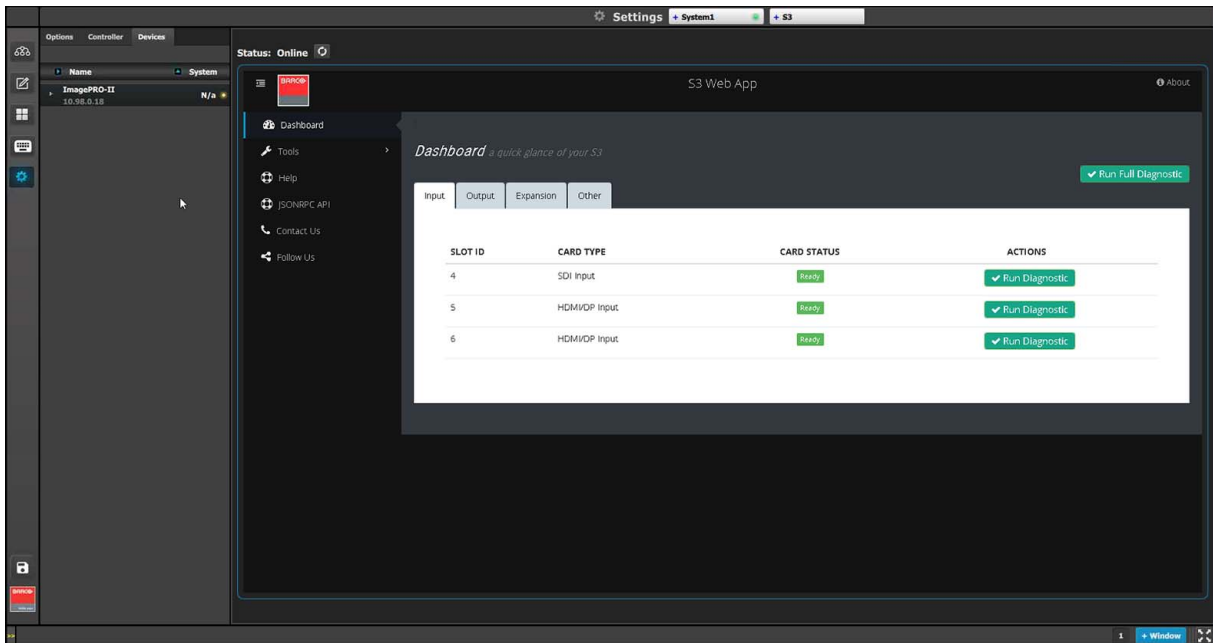

Image 6-101
Devices tab

Dragging and dropping any discovered device from the Resources area to the Web App area hosts the device (for example, an ImagePro II projector) in the Web App area.

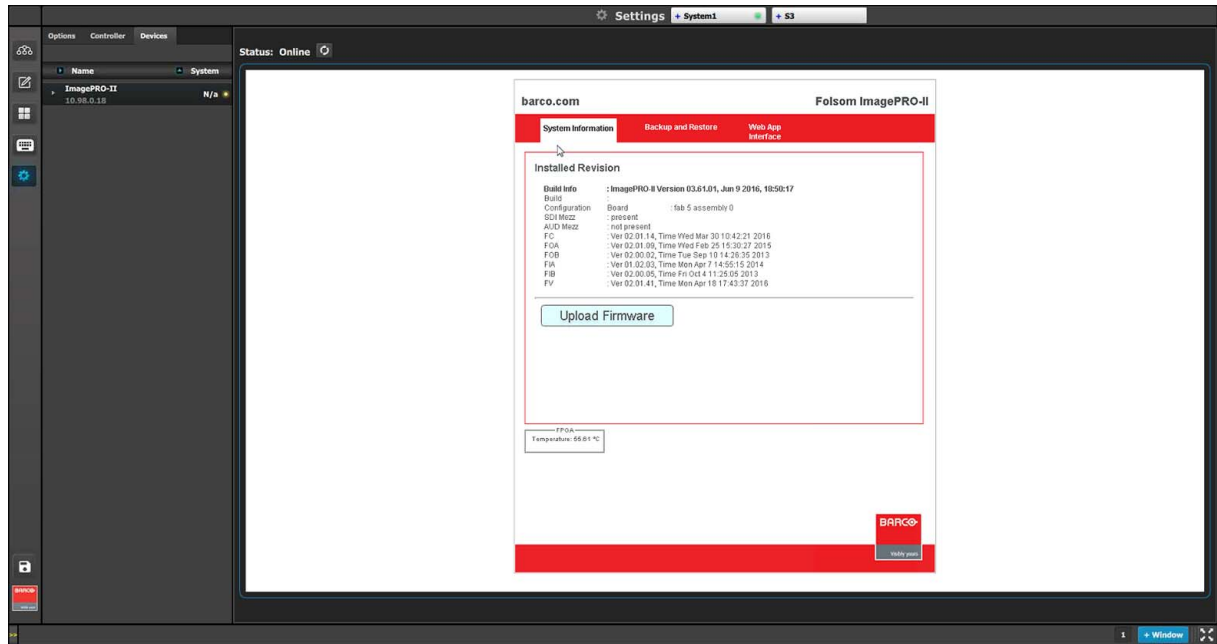

Image 6-102
Devices list

6.39 Settings Menu > Web App area

General

Main work area of the **Setting Menu**, where the user has access to a set of functions directly provided by the Event Master series processor.



All of the functions described in this section can also be performed by launching the web app directly from the browser outside of the GUI. You need to type the unit's IP address into your browser's address bar and the Web app will appear in the browser.

Description

There are several tabs in this area:

- Dashboard: The four submenus in the Dashboard window provide access to card diagnostics software.
- Tools: This menu allows users to Download software and perform Backup and Restore operations.
- Help: This menu contains a list of frequently asked questions to help you implement your system.
- Contact us: Display information to Barco tech support.
- Follow us: Display links to obtain more information about image processing and Barco.

The following sections describe each tab of this area in detail:

- "Settings Menu > Web App area > Dashboard", page 231
- "Settings Menu > Web App area > Tools", page 235
- "Settings Menu > Web App area > Help", page 240
- "Settings Menu > Web App area > Contact us", page 241
- "Settings Menu > Web App area > Follow us", page 242

6.40 Settings Menu > Web App area > Dashboard

General

The four submenus in the Dashboard window provide access to card diagnostics software:

- Inputs
- Outputs
- Expansion
- Other

The user can perform the diagnostic of each card separately, or run a full diagnostic of all unit cards.



CAUTION: Running diagnostics will disrupt output videos. Diagnostics should only be run with no inputs or outputs connected. Do not run diagnostics during live production.

Inputs

The **Inputs** menu presents a list of the input cards installed in the system. The status column indicates whether any errors have been detected. Detailed diagnostics tests for each card are performed by selecting the diagnostics button under the action column.

Dashboard a quick glance of your E2

Input Output Expansion Other ✓ Run Full Diagnostic

SLOT ID	CARD TYPE	CARD STATUS	ACTIONS
3	SDI Input	Ready	✓ Run Diagnostic
4	SDI Input	Ready	✓ Run Diagnostic
5	DVI Input	Ready	✓ Run Diagnostic
6	DVI Input	Ready	✓ Run Diagnostic
7	HDMI/DP Input	Ready	✓ Run Diagnostic
8	HDMI/DP Input	Ready	✓ Run Diagnostic
9	HDMI/DP Input	Ready	✓ Run Diagnostic
10	HDMI/DP Input	Ready	✓ Run Diagnostic

Image 6-103
Dashboard Input

Outputs

This menu presents a list of the output cards installed in the system. The status column indicates whether any errors have been detected. Detailed diagnostics tests for each card are performed by selecting the diagnostics button under the action column.

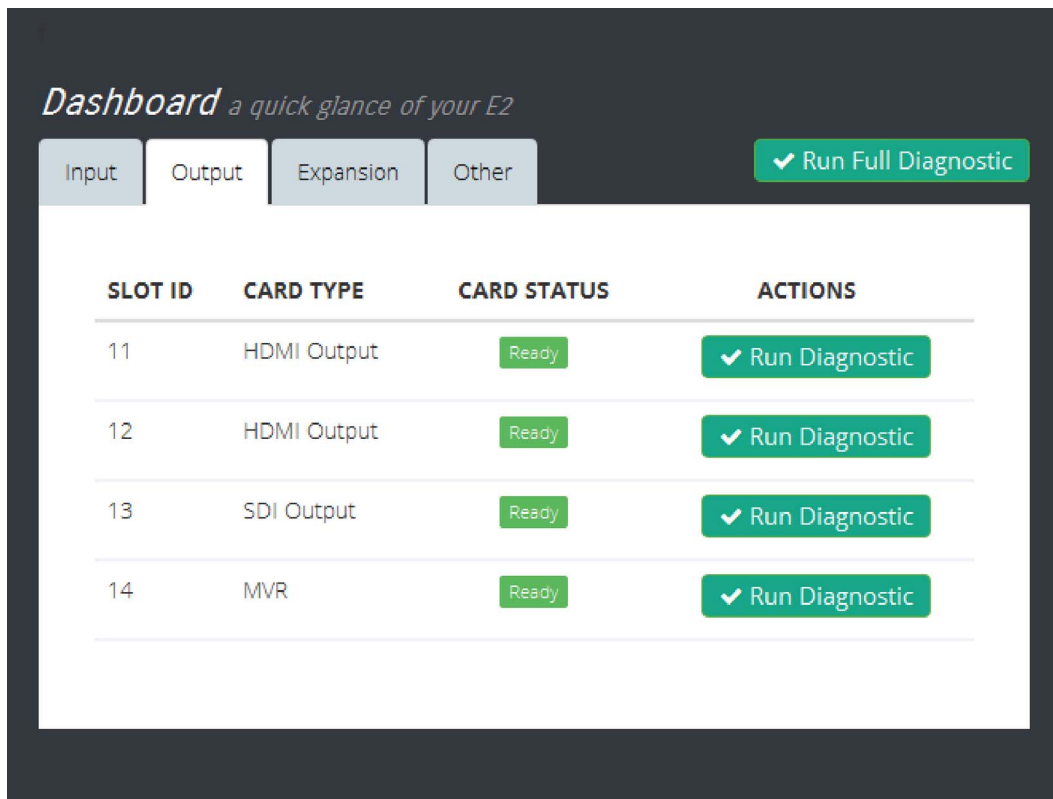

Image 6-104
Dashboard Output

Expansion

This menu presents diagnostics for the Expansion card. The status column indicates whether any errors have been detected. Detailed diagnostics tests for each card are performed by selecting the diagnostics button under the action column.

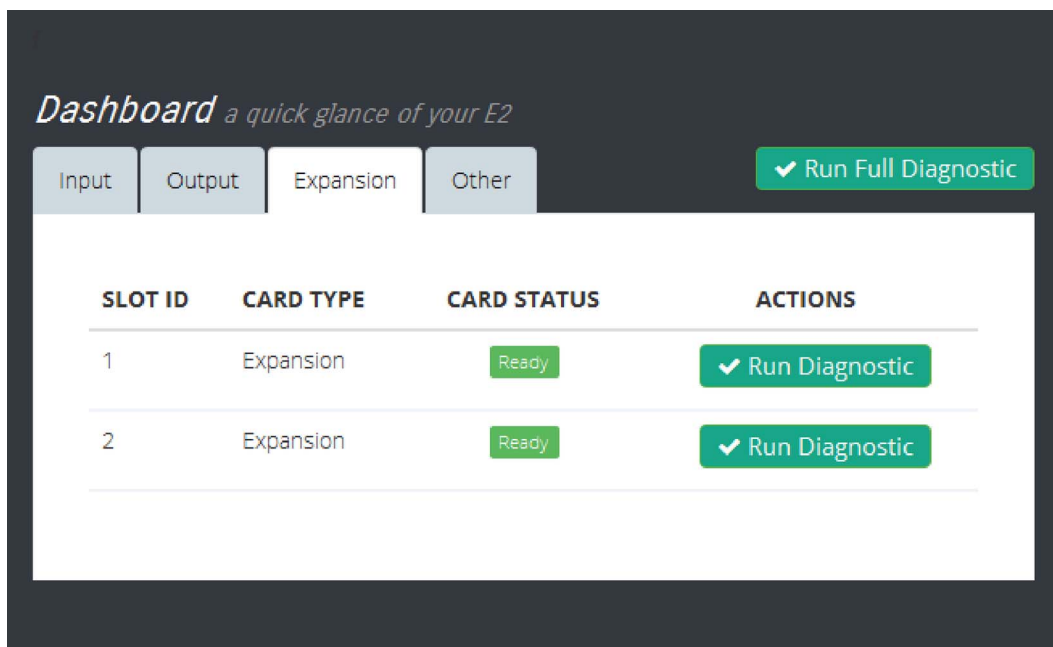

Image 6-105
Dashboard Expansion

Other

This menu presents diagnostics for the Motherboard and internal VPU cards. The status column indicates whether any errors have been detected. Detailed diagnostics tests for each card are performed by selecting the diagnostics button under the action column.



Note that the Motherboard diagnostics test also provides status information for the power supplies.

Dashboard *a quick glance of your E2*

Input Output Expansion Other ✓ Run Full Diagnostic

System / Mainboard

SLOT ID	CARD TYPE	CARD STATUS	ACTIONS
NA	System	Ready	✓ Run Diagnostic

VPU

SLOT ID	CARD TYPE	CARD STATUS	ACTIONS
15	VPU Scaler	Ready	✓ Run Diagnostic
16	VPU Scaler	Ready	✓ Run Diagnostic
17	VPU Scaler	Ready	✓ Run Diagnostic
18	VPU Scaler	Ready	✓ Run Diagnostic
19	Unknown	Not Installed	✓ Run Diagnostic
20	VPU Scaler	Ready	✓ Run Diagnostic
21	VPU Scaler	Ready	✓ Run Diagnostic
22	VPU Scaler	Ready	✓ Run Diagnostic
23	VPU Scaler	Ready	✓ Run Diagnostic

Image 6-106
Dashboard Other

Diagnostics



Running diagnostics will disrupt output videos. Diagnostics should only be run with no inputs or outputs connected. Do not run diagnostics during live production.

Select the Run Diagnostic button for any slot, and the unit generates a detailed report with a Pass or Fail indication.

Diagnostics for slot #1

×

```

Barco: E2, Version 0.6.11440, Nov 12 2014, 20:52:53
Module Info:
  Slot: 1
  Status: Card ready
  Card Type: Expansion
  Fab: 0
  Assembly: 0
  Serial Number: 9693164409
  ARM Version: 0.2.11405
  FPGA Version: 0.0.4
Memory tests:
  EEPROM (FTDI): PASS
FPGA tests:
  Die temperature sensor (C): 36.00
  Fan Tachometer (RPM): 8640
  Power supply sensor:
    Internal rail voltage: 0.99
    Aux rail voltage: 1.78
  Phase loopback: PASS
Communication Tests:
  PCIe:
    FPGA Access: PASS
  SPI:
    FTDI -> FPGA: PASS
    ARM -> FPGA: PASS
  I2C:
    DS125DF410(I28): PASS
    DS125DF410(I25): PASS
    DS125DF410(I30): PASS
    DS125DF410(I22): PASS
    DS125DF410(I32): PASS
    DS125DF410(I24): PASS
    DS125DF410(I33): PASS
    DS125DF410(I23): PASS
    DS125DF410(I31): PASS
    DS125DF410(I27): PASS
    DS125DF410(I29): PASS
    DS125DF410(I26): PASS
DIAG
    
```

Image 6-107
Sample E2 diagnostic report.



FPGA temperatures may reach as high as 85°C under normal operating conditions. Temperatures above 85°C may affect processing performance.

6.41 Settings Menu > Web App area > Tools

General

This menu allows users to Download software update and perform backup or restore the system settings.

Description

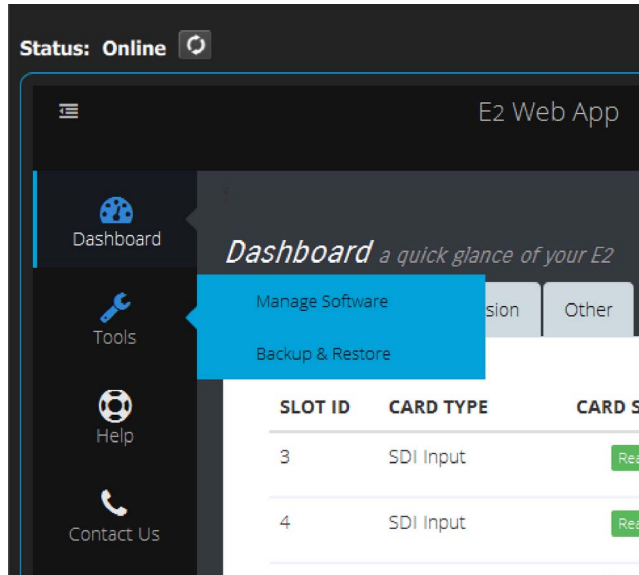

Image 6-108

There are two submenus in this menu:

- **Manage Software:** From this menu the user can select, download and install a new software version from the Barco Server.
- **Backup & Restore:** From this menu the user can backup or restore the system settings.

The following sections describe each submenu in detail:

- "Settings Menu > Web App area > Tools > Manage Software", page 236
- "Settings Menu > Web App area > Tools > Backup & Restore", page 238

6.42 Settings Menu > Web App area > Tools > Manage Software

General

When you select the “Manage Software”, two tabs are presented. The “Software Install” tab and the “Releases” tab.



Although the examples in this section show the E2 processor, the instructions apply to all processors and to the EC-200 controller.

Releases

From this menu you can select and download a new file from the Barco Server. A dialog box allows you to select the location on your computer where the file will be stored.

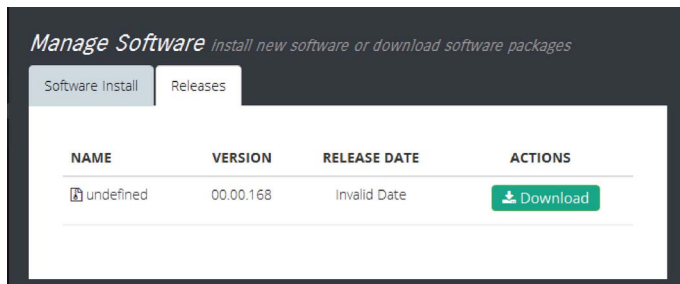

Image 6-109

Software Install

How to upgrade your system:

1. Outside of the GUI open a new window and navigate to the folder containing the file you want to use to upgrade your system with.
2. Select the file and “drag and drop” it on top of the green button. The file is compressed and it has tar.gz extension.

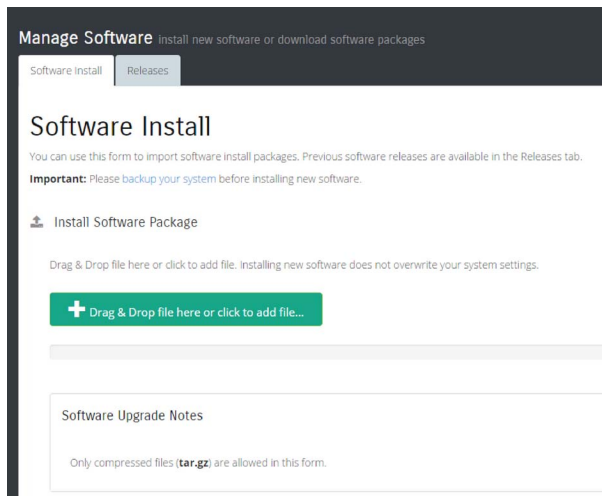

Image 6-110

3. Click on the blue “Upload” button. This action will copy the file from the computer into the Event Master series processor.
4. A green bar appears indicating the progress of the upload process.
5. While the unit updates its software the following message appears:
The system will now restart. Please wait...
Note: The upload process takes several minutes.
6. When the upload is complete, a window appears instructing you to restart the unit.

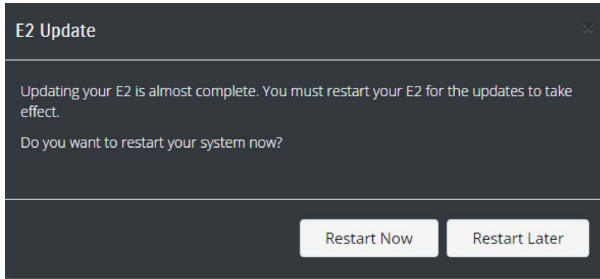

Image 6-111

7. While the system reboots and installs the new software, the web app displays a message indicating that it can't communicate with the unit. This is normal and no action is required on your part.

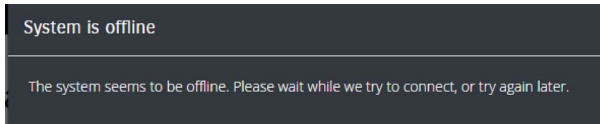

Image 6-112

6.43 Settings Menu > Web App area > Tools > Backup & Restore

General

In this menu the user can store presets, user keys and other system settings on the computer. The menu also allows the user to restore a previously stored system file.

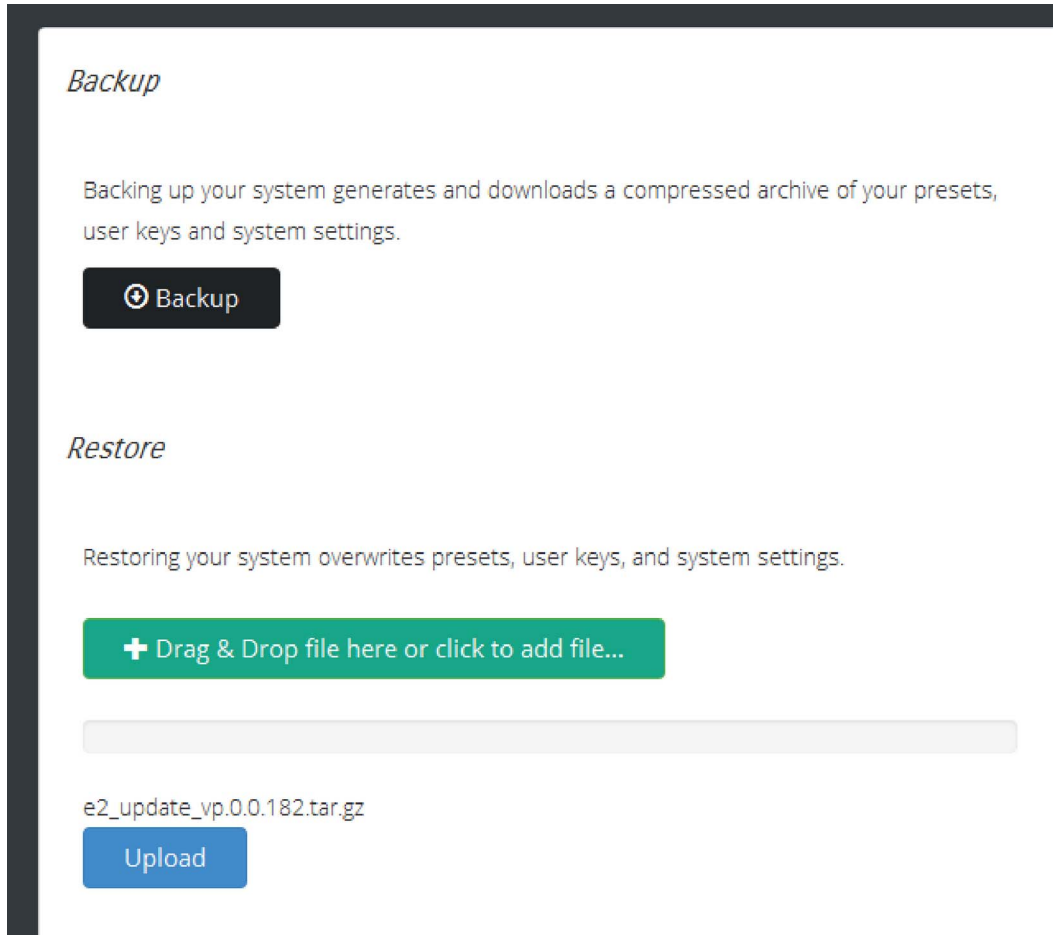

Image 6-113

How to backup presets, user keys and system settings

1. Click on the **Backup** button.

A dialog box opens up.

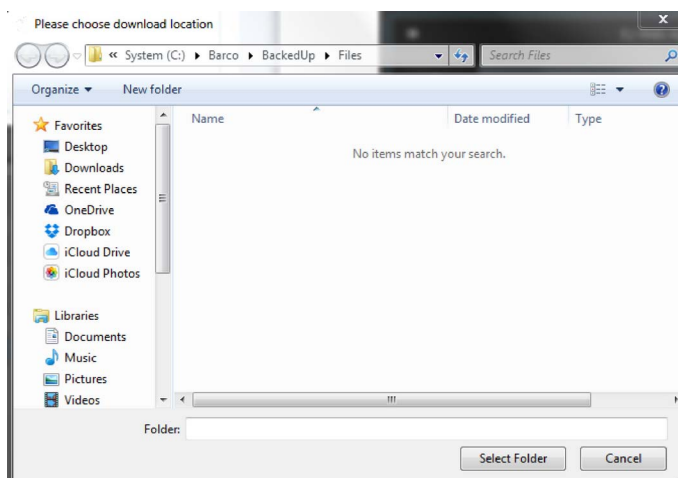

Image 6-114

2. Choose the folder location where you want to store the backed up file.
3. Click on **Select Folder**.

The Dialog box will close and a new window appears displaying the location and name of the stored compressed file.

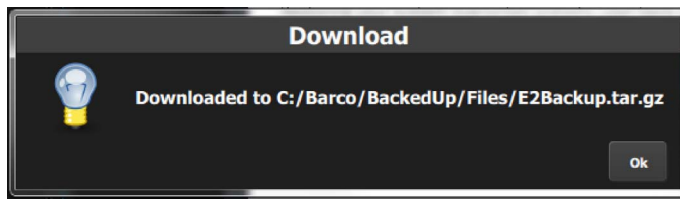

Image 6-115

4. Click on **OK**.

How to restore presets, user keys and system settings

The following procedure allows the user to restore a backed up file into a Event Master series processor:

1. Open an explorer window and navigate to the location where the backed up file is located.
2. Drag and drop the file on the green restore button.
A progress bar and a blue **Upload** button appear.
3. Click on the **Upload** button
The progress bar indicates the status of the upload procedure.
4. When the upload is complete a new window appears requesting you to restart the system.
5. While the system reboots and restore parameters, the web app displays a message indicating that it can't communicate with the unit. This is normal and no action is required on your part.

6.44 Settings Menu > Web App area > Help

General

This menu contains a list of frequently asked questions (FAQ) to help you implement your system. This list is sorted by category.

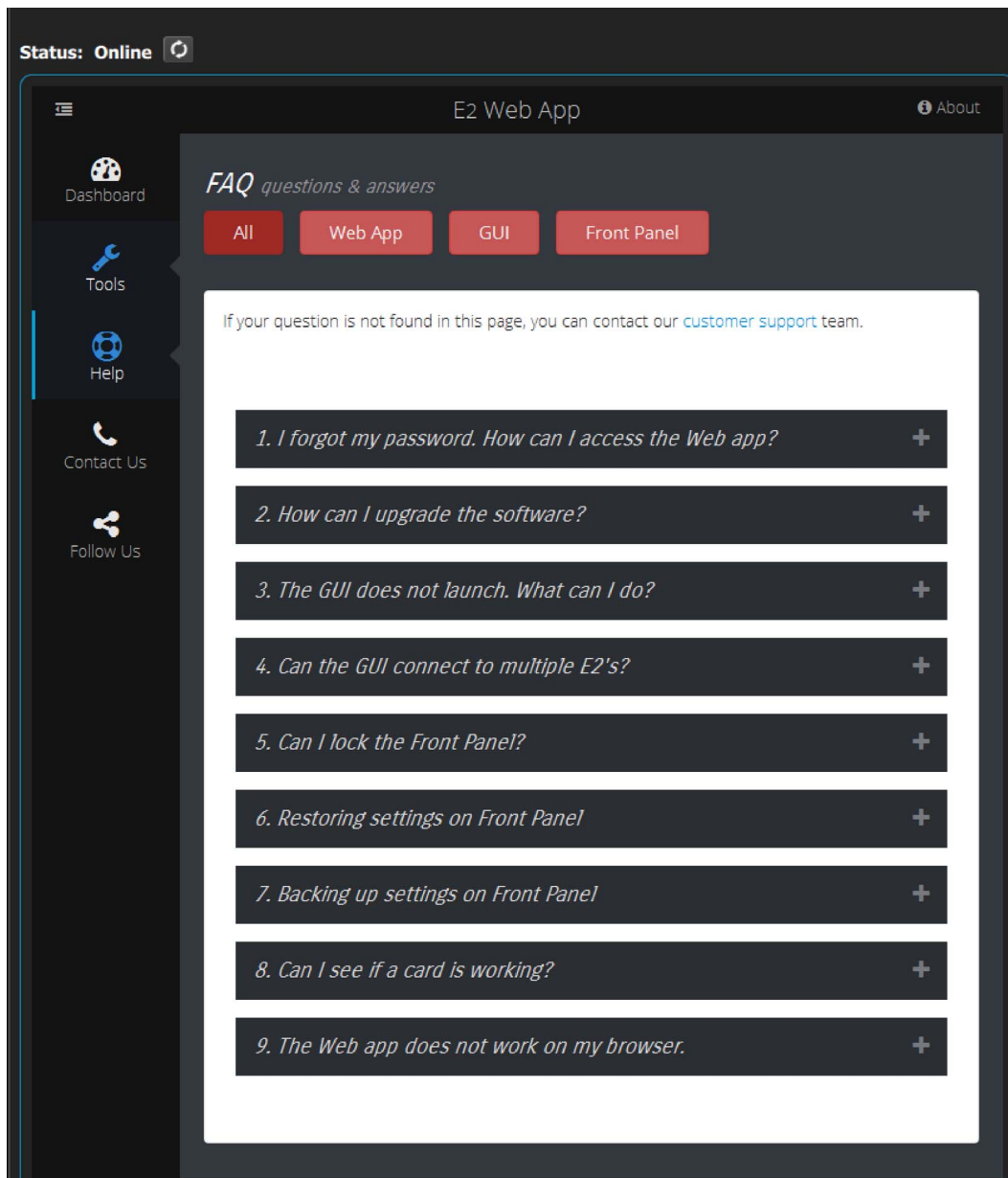

Image 6-116

6.45 Settings Menu > Web App area > Contact us

General

Displays contact information for the Barco tech support.

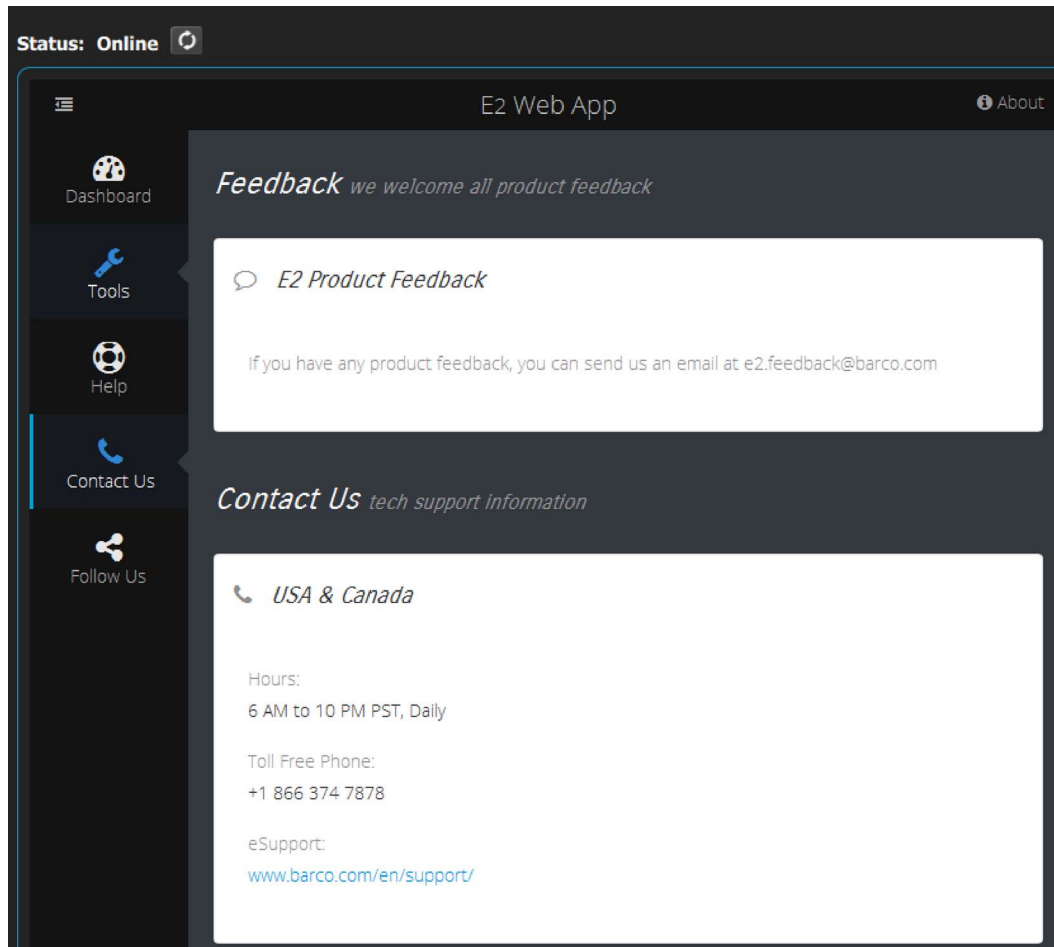

Image 6-117

6.46 Settings Menu > Web App area > Follow us

General

Displays links to Barco's and the Image Processing group's social media sites.

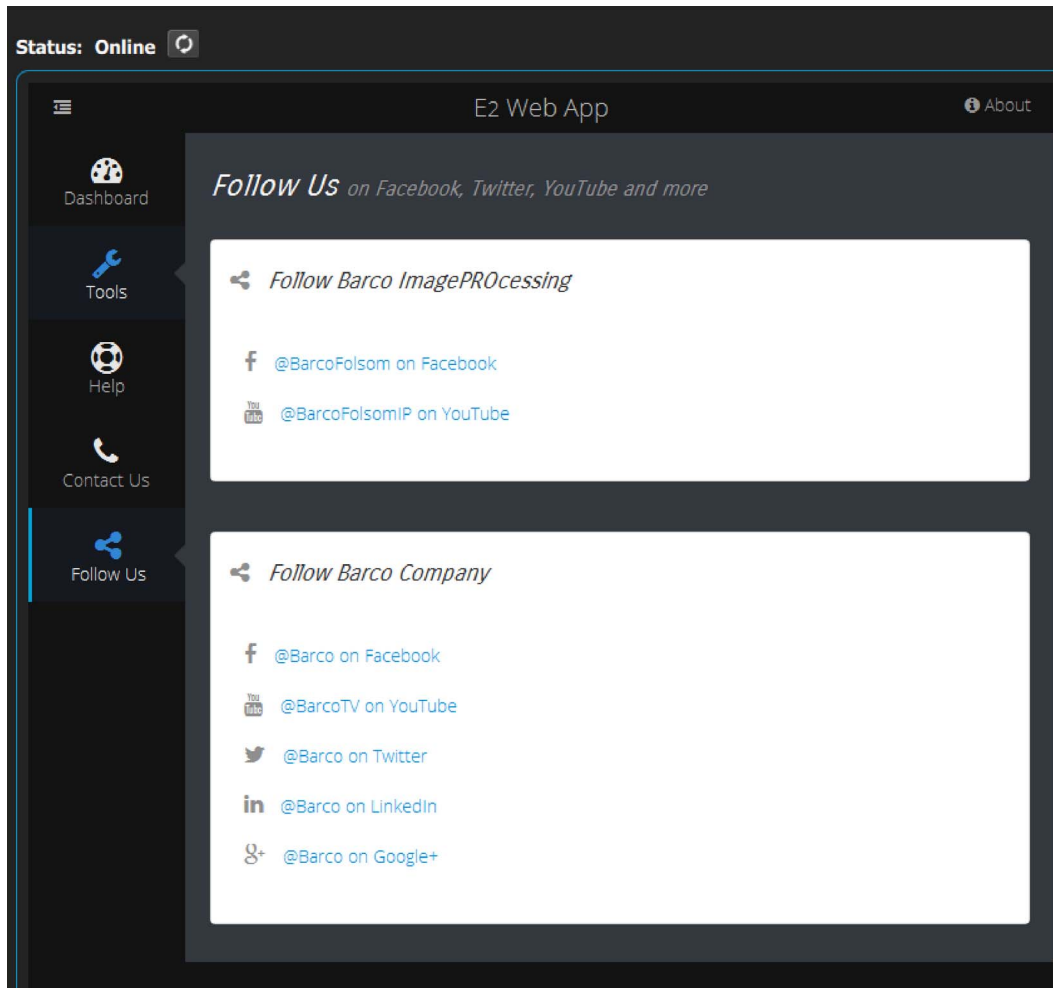

Image 6-118

7. SYSTEM SETUP

About this chapter

This chapter outlines procedures for setting up and configuring Event Master series processors.



CAUTION: Before starting to set up your Event Master series processor, please ensure that you are familiar with front panel menus and Event Master Toolset Software.

Overview

- Setup Prerequisites
- System setup sequence
- Power up and Status check
- Return to factory default
- Communication setup
- Restoring the system
- User preference setup
- Saving the setup
- Backing up the system
- Configuration Menu > Initial Setup
- Configuration Menu > Add Background(s)
- Configuration Menu > Add Inputs
- Configuration Menu > Add Outputs
- Configuration Menu > Add Screen Destinations & Layers
- Configuration Menu > Layer optimization
- Configuration Menu > Add Aux Destinations
- Configuration Menu > Add MVR Outputs
- Programming Menu > Capture Stillstore from Inputs & Backgrounds
- Programming Menu > Select Thumbnails for Backgrounds
- Programming Menu > Select Thumbnails for Inputs
- Programming Menu > Create Sources from Inputs
- Programming Menu > Drop backgrounds into Screen Destinations
- Programming Menu > Drop Sources, Layers into Screen Destinations & Sources into layers
- Programming Menu > Drop Inputs to Aux Destinations
- Programming Menu > Presets And User Keys
- Programming Menu > Destination Transition
- Multiviewer Menu > Drop Inputs, Backgrounds and Destinations

7.1 Setup Prerequisites

Prerequisites

Before starting to set up your Event Master series processor, please review the following prerequisites:

- Ensure that you are familiar with the Event Master devices, including system control means and features. For details, please refer to Chapter "General", page 19.
- Ensure that you are familiar with front panel menus of the Event Master processors. For details on all menus, please refer to chapter "Front Panel Menu orientation", page 71
- Ensure that you are familiar with front panel menus and Event Master Toolset Software. For details on Event Master Toolset Software, please refer to chapter "EM GUI orientation", page 97
- Ensure that the unit is physically secured on a rack or is placed on a flat surface with a stable support. If the unit is installed on a rack, it is mandatory that the rear brackets are also installed. For details, please refer to chapter "Rack-Mount Procedure", page 40.
- Ensure that all hardware is properly installed, and that all sources, displays and peripherals are properly connected. For details concerning Event Master series processor connectors, please refer to the unit rear panel description in the chapter "Rear panel", page 46.
- Connect the AC power to the unit. If power redundancy is desired, connect power to both power plugs.
- Make sure that the Event Master series processor is connected to the Ethernet local network in order to communicate with the PC where the control software is installed.

7.2 System setup sequence

Set up from A to Z

This section provides a top level view of the entire Event Master series processor setup procedure, plus links to each individual sequence.



For the optimum Event Master series processor setup, it is recommended that you follow all procedures in the order outlined below.

Set up from A to Z

1. **Power up and Status check.** For more information see section "Power up and Status check", page 246.
2. **Return to factory default.** For more information see section "Return to factory default", page 247.
3. **Communication setup** allows setup to the Ethernet settings. For more information see section "Communication setup", page 248.
4. **Restoring the system** procedure restores the system to a previously saved configuration from a USB drive. For more information see section "Restoring the system", page 249.
5. **User preference setup** is used to set a variety of important user preferences. For more information see section "User preference setup", page 250.
6. **Saving the setup** procedure saves all system setup parameters. For more information see section "Saving the setup", page 251.
7. **Backing up the system** procedure backs up your system configuration to a USB drive. For more information see section "Backing up the system", page 252.
8. **Configuring Menu > Initial Setup.** For more information see section "Configuration Menu > Initial Setup", page 253.
9. **Configuring Menu > Add Background(s).** For more information see section "Configuration Menu > Add Background(s)", page 254.
10. **Configuring Menu > Add Inputs.** For more information see section "Configuration Menu > Add Inputs", page 255.
11. **Configuring Menu > Add Outputs.** For more information see section "Configuration Menu > Add Outputs", page 257.
12. **Configuring Menu > Add Screen Destinations & Layers.** For more information see section "Configuration Menu > Add Screen Destinations & Layers", page 260.
13. **Configuration Menu > Layer optimization.** For more information see section "Configuration Menu > Layer optimization", page 263.
14. **Configuring Menu > Add Aux Destinations.** For more information see section "Configuration Menu > Add Aux Destinations", page 264.
15. **Configuring Menu > Add MVR Outputs.** For more information see section "Configuration Menu > Add MVR Outputs", page 266.
16. **Programming Menu > Capture Stillstore from Inputs & Backgrounds.** For more information see section "Programming Menu > Capture Stillstore from Inputs & Backgrounds", page 268.
17. **Programming Menu > Select Thumbnails for Backgrounds.** For more information see section "Programming Menu > Select Thumbnails for Backgrounds", page 269.
18. **Programming Menu > Select Thumbnails for Inputs.** For more information see section "Programming Menu > Select Thumbnails for Inputs", page 270.
19. **Programming Menu > Create Sources from Inputs.** For more information see section "Programming Menu > Create Sources from Inputs", page 271.
20. **Programming Menu > Drop backgrounds into Screen Destinations.** For more information see section "Programming Menu > Drop backgrounds into Screen Destinations", page 272.
21. **Programming Menu > Drop Layers into Screen Destinations & Sources into layers.** For more information see section "Programming Menu > Drop Sources, Layers into Screen Destinations & Sources into layers", page 273.
22. **Programming Menu > Drop Inputs to Aux Destinations.** For more information see section "Programming Menu > Drop Inputs to Aux Destinations", page 275.
23. **Programming Menu > Presets And User Keys.** For more information see section "Programming Menu > Presets And User Keys", page 276.
24. **Programming Menu > Destination Transition.** For more information see section "Programming Menu > Destination Transition", page 277.
25. **Multiviewer Menu > Drop Inputs, Backgrounds and Destinations.** For more information see section "Multiviewer Menu > Drop Inputs, Backgrounds and Destinations", page 278.

7.3 Power up and Status check

General

Use the following steps to power up your Event Master series processor and check system status.

Prerequisite

- Ensure that your system is properly installed and cabled.
- Ensure that you are familiar with the **System Menu**. For details on all menus, please refer to chapter "Front Panel Menu orientation", page 71.

Power up system and check system status

1. Turn on the unit and wait while it initializes. During the initialization process the front panel displays: "Program Loading Please Wait".

The **Status** Menu is automatically displayed after initialization is completed.

2. Power up all peripherals, such as display devices (projectors, monitors) and sources.
3. Turn on the PC and run the Event Master Toolset Software.

The system configuration page is the first page that appears when the Event Master Toolset Software is launched.

4. On the **Status** Menu:

- **System1** is the default value displayed as System Name if this is the first start of the unit. This name can be changed in the configuration page of the GUI.
- Ensure the Event Master series processor is connected on the local network. If there is no internet connection, or if a DHCP server has not been found, the IP address is 000.000.000.000. In this case, re-check all Ethernet connections. After checking connections, if devices still report "Not Connected," use the procedure "Communication setup", page 248.

7.4 Return to factory default

General

Prior to performing any setup procedures, it is recommended that you perform a factory reset — in order to reset all input, output and source mappings to their default values.

Particularly for customers in the events and rental marketplace, this procedure guarantees that any previous input setups and memory registers (e.g., those that may have been programmed by other users) are completely cleared from system memory.



If you are continuing an event (for example, day two of a three-day event), you do not need to perform a factory reset. However, if you do elect to perform a factory reset, ensure that you have backed up your system. For details, please refer to the procedure "Backing up the system", page 252.

Prerequisite

- Ensure that you are familiar with the **Reset Menu**. For details on all menus, please refer to chapter "Restoring Factory Default Settings", page 93.

Restoring factory settings

To restore all default settings to the Event Master series processor, use the following procedure:

1. Select **Factory Reset** from the **Setup** Menu.

The **Factory Reset** Menu appears.

2. Select **Factory Reset** to reset the entire system to its factory default values. Remember that all data will be lost.

Or,

Select **Factory Reset, Save IP** to reset the entire system to its factory default values, but retains the IP address of the unit.

A prompt appears, asking if you want to clear all configurations.

3. Press **SEL**.

The system turns off, then it reboots.

7.5 Communication setup

General

In this procedure, you will set up communication between the Event Master series processor and the local network.

Prerequisite

- Ensure that you are familiar with the **Ethernet Menu**. For details on this menu, please refer to chapter "System menu > Ethernet", page 84.

Static IP or DHCP?

Use one of the following procedure to:

- turn on the DHCP feature and query the DHCP server to obtain a valid IP address. A DHCP server must be available on the local network.
- or turn off the DHCP feature and set a static IP address for the Event Master series processor, along with a subnet mask and gateway.



Define the Ethernet settings to remotely access is mandatory to control the Event Master series processor via the Event Master Toolset Software or via a web interface. Please contact the manager of the local network (LAN) to know how configuring your device.

Query the DHCP server

1. Select **Ethernet** from the **System Menu**.

The **Ethernet** Menu appears.

2. Turn On the **DHCP** value.

The Event Master series processor automatically queries the DHCP server for a valid IP address. If the Event Master series processor receives an IP address, that address is displayed in the Ethernet submenu.



It can take several seconds to obtain an address from the server. During this time, the SEL button remains lit.

Setting a static IP Address

1. Select **Ethernet** from the **System Menu**.

The **Ethernet** Menu appears.

2. Turn Off the **DHCP** value.

3. Select **Set Static IP** from the **Ethernet Menu**.

The **Set Static Ip** Menu appears.

4. Select and set successively the **SUB**(net), **GW** and **IP** fields.

Note: You must change the **SUB** parameter before editing either of the other parameters.

7.6 Restoring the system



This step in the Event Master series processor setup procedure is optional. If there is not backup available or if you decide to configure your unit from scratch, please move to the next step to continue the procedure.

General

In this procedure, you will restore your system configuration from a USB drive — provided that you previously backed up your system to a USB drive.

Prerequisite

- Ensure that you are familiar with the **USB device (Backup/Restore) Menu**. For details on this menu, please refer to chapter "System menu > USB device (Backup/Restore)", page 80.

Restore a system configuration file

Use the following steps to restore your system from the USB Drive:

1. Insert a formatted flash drive in the unit's front-panel USB port.
2. From the **System** menu, scroll to the **USB Backup/Restore** submenu. Select **Restore Config**.
The **USB Restore Config** submenu appears.
3. Press **SEL** and scroll through the list of configuration files. When you locate the file you want, press **SEL** again.
A message confirms the restore operation and instructs you to reboot the Event Master series processor.



You must reboot the system to use the restored configuration file.



At the conclusion of this procedure, your system is completely set up — exactly the way that you left it when you performed a complete system "backup." No further setup operations are required.

7.7 User preference setup

General

This procedure enables you to set a variety of important user preferences and options.

Prerequisite

- Ensure that you are familiar with the **Black Invalid** menu. For details on this menu, please refer to chapter "System menu > Black Invalid", page 79.
- Ensure that you are familiar with the **VFD brightness** menu. For details on this menu, please refer to chapter "System menu > VFD brightness (display brightness)", page 86.

Set a variety of important user preferences

Use the following steps to set user preferences:

1. Select **System** from the **Setup** menu.
2. Select **Black Invalid** from the **System** menu to set Black on Invalid Video on or off.
3. Select **VFD brightness** from the **System** menu to adjust the intensity of the front panel vacuum fluorescent display (VFD) screen, from 1 (dim) to 6 (bright).

7.8 Saving the setup

General

In this procedure, you will save all system setup parameters to non-volatile memory.

Prerequisite

- Ensure that you are familiar with the **Save All** function. For details on this menu, please refer to chapter "Save All", page 95.

Save all system setup parameters

Use the following steps to save all system setup parameters:

1. Select **Save All** from the **Setup** menu.
2. Wait a few seconds. When the parameters are saved you are returned to the **Setup** menu.

7.9 Backing up the system

General

In this procedure, you will back up your system configuration to a USB drive.

Prerequisite

- Ensure that you are familiar with the **USB device (Backup/Restore) Menu**. For details on this menu, please refer to chapter "System menu > USB device (Backup/Restore)", page 80.

Back up a system configuration file

Use the following steps to back up your system to a USB Drive:

1. Insert a formatted flash drive in the unit's front-panel USB port.
2. From the **System** menu, scroll to the **USB Backup/Restore** submenu. Select **Backup Config**.
The **USB Backup Config** submenu appears. The navigation cursor appears at the default name for the first backup file.
3. If you wish to change the default name of the backup configuration, press **SEL**. Use the **ADJUST** knob to change the name, as described in section "Using menu system", page 74. Press **SEL** again when you complete the name change.
4. Scroll to **Backup Config** and press **SEL**.

A confirmation message appears when the backup is complete.

7.10 Configuration Menu > Initial Setup

General

In this procedure, you will run the Event Master Toolset Software (EMTS), verify communication between the Event Master series processor (EMP) and the program to the local network and perform basic setup.

Prerequisite

- Ensure that you are familiar with the **Configuration Menu**. For details on this menu, please refer to chapter "Configuration Menu", page 106

Setup

1. Connect the PC running the EMTS to the same local network switch that the EMP is connected to. Run the EMTS and the software should connect to EMP automatically. The unit is listed in the System configuration page under the **Discovered** tab with the button on turning yellow.
2. Drag and drop the EMP from the device area into the middle diagram area.
3. If multiple units are connected to the PC, the yellow LEDs next to the system will turn green. You can assign a unique name to each unit. Confirm that you are connected to the right unit by clicking the arrow in front of EMP to reveal the unit's IP address. Verify that this address is the same as the address listed on the unit's front panel on the top status menu.
Note: *If the unit doesn't connect automatically to the PC, you can type the PC's IP address in the field under "Manual Connect". A reason for this can be the PC's firewall settings. Be sure to allow full communication for EMTS and EMP.*
4. **(Optional)** Select the EMP's native vertical refresh rate from the "**Native Rate:**" drop-down menu. Default value is 59.94Hz.
5. **(Optional)** Select the EMP's Scaler capacity from the "**Scaler Mode:**" drop-down menu. Possible are 2K / DL and 4K setting the maximum scaling capacity for the Layer. Default value is 2K (HD).
6. **(Optional)** Select the EMP's Genlock mode from "**Genlock**" drop-down menu. Default value is OFF.

7.11 Configuration Menu > Add Background(s)

General

In this procedure, you will assign Backgrounds from the input connector(s).

Prerequisite

- Ensure that you are familiar with the **Configuration Menu**. For details on this menu, please refer to chapter "Configuration Menu", page 106



If more than one background is utilized, repeat the below steps until all backgrounds are added and adjusted.

Add Background

1. Click on the **Background** tab to select the input that will be assigned as a background.
2. Click on the **+Add Background** blue button to enter the Add mode.
3. Click on the connector that the background signal is connected to define it as a background. If the background spans into multiple connectors, click on all connector before you proceed. All connectors can be used as backgrounds, connector type and capacity needs to match. DVI and HDMI can be mixed.
4. Click on the **"Done Adding"** button to exit the Add mode.

(Optional) Edit the Name

1. Double click on default name in the Name list to edit the name.
2. When the area turns blue, click the **eraser** icon to clear the field.
3. Type a new name.

(Optional) Adjust Background Parameters

Click on the **Adjust** tab that is located on the top. From this menu you can adjust:

1. Select Format value, color space and connector type. Default value is 1920x1080p @ 59.94.
2. Select the background orientation, vertical or horizontal.
3. Select EDID format (for DVI, HDMI and DisplayPort inputs). Select EDID from the drop-down list, then select frame rate from the drop-down list and finally select **Apply**.
4. Apply specific EDID parameters based on a standard EDID. VESA calculator needs to be used.
5. If several connectors should have the same EDID, check the Apply to all Backgrounds checkbox before Apply and Save.
6. Select HDCP mode (for DVI, HDMI and DisplayPort inputs).
7. Select color space, capacity and type (for SDI inputs).
8. Perform color adjustments.
9. Read all timing parameters associated with the selected format.
10. Add information like Passwords for connected computers or Phone numbers to a Specialist.

(Optional) Delete Backgrounds

1. Click on the blue button **Delete Backgrounds**.
2. From the Name list click on the **"x"** space next to the Background(s) you wish to delete. Or click on connectors.
3. Hit the red button **Delete Background(s)** button. All of the selected Background will be removed from the list.

7.12 Configuration Menu > Add Inputs

General

In this procedure, you will add Inputs to the system. The system must have inputs added in order for them to be available.

Prerequisite

- Ensure that you are familiar with the **Configuration Menu**. For details on this menu, please refer to chapter "Configuration Menu", page 106



If more than one Input is utilized, repeat the below steps until all Inputs are added and adjusted.

Connector Capacity

Each connector has a capacity setting that assigns internal resources to the connector. Likewise does it also free up resources for the other connectors. If two Dual Link Connectors is expected on any of the HDMI/DP cards, two other connectors needs to be set to "NONE".

If a connector is to be used to accommodate a 4K signal all other connectors on each card needs to be set to "NONE".

(Optional) Auto create all Inputs

If the Auto create Inputs is pressed, then the software will add all unassigned inputs to the input list and number them sequentially.

This button is a shortcut for systems utilizing a large number of inputs.

(Optional) Auto create all live Inputs

If the Auto create all Inputs is pressed, then the software will add all unassigned inputs with input signal detected (yellow) to the input list and number them sequentially.

This button is a shortcut for systems utilizing a large number of inputs.

Add Input

This is where you add specific input requirements in order to allow Dual Link inputs of 3840x1080, UHD and 4K.

1. Click on the **Input** tab to select the inputs that will be defined.
2. Click on the **+Add Input** blue button to enter the Add mode.
3. Click on the connector that the input signal is connected to define it as an input. Up to 4 connectors can be added into a Connector Group with a maximum resolution of 4K.
4. Click on the **Done Adding** button to exit the Add mode.

(Optional) Adjust Input Parameters

Click on the **Adjust** tab that is located on the top. From this menu you can adjust:

1. Select Format value, color space and connector type. Default value is 1920x1080p @ 59.94.
2. Set Connector mapping, Horizontal is Default.
3. Select EDID format (for DVI, HDMI and DisplayPort inputs). Select EDID from the drop-down list, then select frame rate from the drop-down list and finally select Apply.
4. Apply specific EDID parameters based on a standard EDID. VESA calculator needs to be used.
5. If several connectors should have the same EDID, check the Apply to all Backgrounds checkbox before Apply and Save.
6. Select HDCP mode (for DVI, HDMI and DisplayPort inputs).
7. Select color space, capacity and type (for SDI inputs).
8. Perform color adjustments.
9. Read all timing parameters associated with the selected format.

(Optional) Delete Inputs

1. Click on the blue button **Delete Input(s)**.
2. From the Name list click on the "x" space next to the Input(s) you wish to delete. Or select connectors.
3. Hit the red button **Delete Input(s)** button. All of the selected Inputs will be removed from the list.

(Optional) Edit the Name

1. Double click on default name in the Name list to edit the name.

7. System Setup

2. When the area turns blue, click the **eraser** icon to clear the field.
3. Type a new name.

Note: *It is recommended to name inputs based on the actual connection scenario instead of the connected devices function. This is due to several layers of naming that can be done in the system to simplify understanding during operation.*

7.13 Configuration Menu > Add Outputs

General

In this procedure, you will add Outputs to the system .

Prerequisite

- Ensure that you are familiar with the **Configuration Menu**. For details on this menu, please refer to chapter "Configuration Menu", page 106



If more than one Output is utilized, repeat the below steps until all inputs are added and adjusted.

Connector Capacity

Each connector has a capacity setting that assigns internal resources to the connector. Likewise does it also free up resources for the other connectors. If two Dual Link Connectors is expected on any of the HDMI / DVI cards, two other connectors needs to be set to "NONE".

If a connector is to be used to accommodate a 4K signal all other connectors on each card needs to be set to "NONE".

SDI Output can only output UHD/4K over a Quad connection.

(Optional) Auto create Outputs

If the Auto create Outputs is pressed, then the software will add all unassigned outputs to the output list and number them sequentially.

This button is a shortcut for systems utilizing a large number of outputs.

(Optional) Edit the Name

Once all connectors are added they appear in a list directly under the Output Tab. It is recommended to name outputs based on the actual connection scenario instead of the connected devices function. This is due to several layers of naming that can be done in the system to simplify understanding during operation.

1. Double click on default name in the Name list to edit the name.
2. When the area turns blue, click the **eraser** icon to clear the field.
3. Type a new name.

Add Output

This is where you add specific output requirements in order to allow Dual Link inputs of 3840x1080, UHD and 4K

1. Click on the **Output** tab to select the outputs that will be defined.
2. Click on the **+Add Output** blue button to enter the Add mode.
3. Click on the connector that the display device is connected to add it as an output. 2 or 4 connectors can be added into a Connector Group with a max resolution of 4K. It is recommended to Group Connectors in this step for UHD / 4K Displaydevices. Only the two top connectors have highspeed link capability allowing over 2K resolutions.
4. Click on the **Done Adding** button to exit the Add mode.

(Optional) Delete Outputs

1. Click on the blue button **Delete Output(s)**.
2. From the Name list click on the "x" space next to the Output(s) you wish to delete. Or select the connector.
3. Hit the red button **Delete Output(s)** button. All of the selected Outputs will be removed from the list.

(Optional) Adjust Output Parameters

Click on the **Adjust** tab that is located on the top. The output adjustment panel is divided in three sections (Main, Timing, Connector). In the Adjustment panel you can:

1. [Main tab] Edit the name.
2. [Main tab] Select Format value and Frame Rate.
3. [Main tab] Enable Test Patterns with raster box and enable diagonal motion.
4. [Main tab] Define the Area of interest (AOI).

7. System Setup

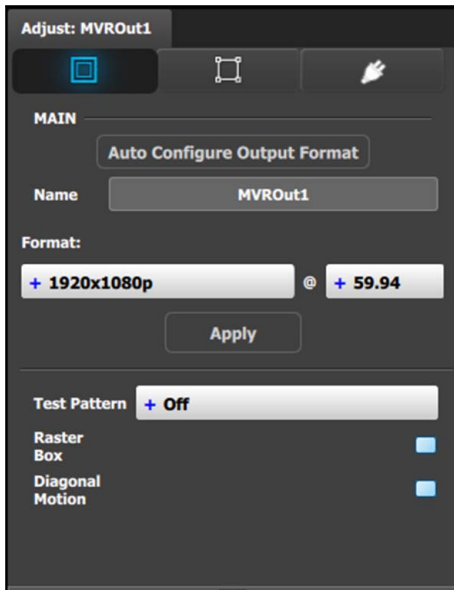

Image 7-1
Adjust MVR panel—Main

5. [Timing tab] Read all timing parameters associated with the selected format and make adjustments.

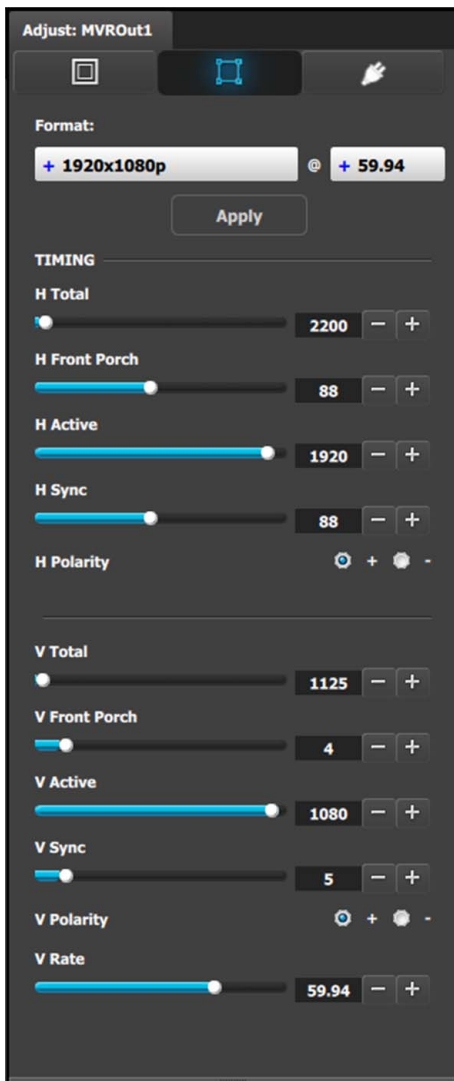

Image 7-2
Adjust MVR panel—Timing

6. [Connector tab] Select SDI type and Sync standards.

7. [Connector tab] Select Color space and Sample bit depth available as reported from the EDID of the Device.
8. [Connector tab] Change Connector capacity as long as the connector is not included in a Destination.
9. [Connector tab] Select HDCP Mode **On** or **Off**.
The default for HDMI outputs is Off. To turn On the HDCP Mode, click on the empty checkbox. When the checkbox displays a check mark, HDCP Mode is On. HDCP Mode is not applicable to SDI outputs.

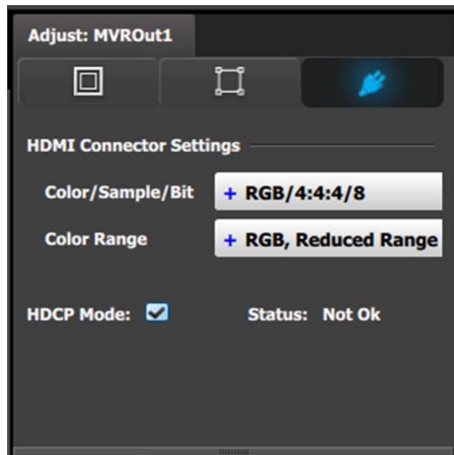

Image 7-3
Adjust MVR panel—Connector

7.14 Configuration Menu > Add Screen Destinations & Layers

General

In this procedure, you will Add Screen Destinations from the defined outputs.

Prerequisite

- Ensure that you are familiar with the **Configuration Menu**. For details on this menu, please refer to chapter "Configuration Menu", page 106



If more than one Destination is utilized, repeat the below steps until all Destinations are added.

Add Screen Destinations

1. Click on the **Destination** tab to define destinations for the defined outputs.
2. From the diagram area click on the output that you want to be part of the destination. If no connector is selected the first available connector will be selected.
3. Click on the **+Add Screen Destination** blue button to assign the output to the screen destination.
4. When the destination is created a box appears next to the unit diagram.
5. If there is more than one output part of the destination, for a widescreen for instance, drag and drop these outputs into the destination box. You will observe that the destination size automatically updates as new outputs are added to the destination.



An EMP allows only a certain mix of Screen (Program) Destinations and AUX Destinations. Each card can support up to four (4) Screen Destinations (Program Outputs), or up to four (4) AUX outputs, or two (2) AUX and two (2) Screen Outputs. All Outputs can be AUX Destinations, and all Outputs can be assigned to Screen Destinations. Screen Destination sizes are determined by the available amount of pixel canvas, not by the number of Outputs assigned to a Screen Destination.

Add Layers to Destinations

Click on the **Adjust** tab that is located on the top.

1. Under the **Assign** sub-menu click on the **+Assign Layer to Destination** blue button.
2. Click on this button as many times is required to add the layers you are assigning to the destination. Observe the number of layers indicated in the Layer box is incremented every time the add button is pressed. See also "Configuration Menu > Layer optimization", page 263.
3. If you need to delete layers, click on the Blue button **Delete layers**.

(Optional) Edit the Name

1. Double click on "Destination1" in the Name list to edit the name.
2. When the area turns blue, click the eraser icon to clear the field.
3. Type a new name and hit enter when done.

(Optional) Adjust Destination Parameters

Click on the "Adjust" tab that is located on the top. In this Tab there are three sub tabs: Assign, Output and Wide (See below).

(Optional) Adjust Destination Parameters part 1 > Assign Tab

From this menu you can:

1. Edit the name.
2. Change the Destination from Screen to Aux.
3. Set the dimensions if more than one connector.
4. Use the Auto Configure Output Format function that reads the EDID of the connected device and will produce a signal like that if still within the rules of VESA timings.
5. Delete outputs.
6. Assign or Delete Layers.

(Optional) Adjust Destination Parameters part 2 > Output Tab

From this menu you can:

1. See the output canvas (raster) size.

2. See in what order and place the outputs populate the Destination.
3. Select outputs for manipulation.
4. Choose more actions in sub tabs:



- Position:
 - o Enable Test Patterns with raster box and enable diagonal motion
 - o Define the Area of interest (AOI).



- Color:
 - o Perform color adjustments.



- Timing:
 - o Read the timing parameters associated with the selected format.



- Connector Settings:
 - o Select SDI type and SMPTE standards.

(Optional) Adjust Destination Parameters part 3 > Wide Tab

From this menu you choose between the two sub tabs:

- **Datadouble**, where you can adjust data Doubling parameters based on the selection done in the window below.



Image 7-4

7. System Setup

- **Feathering**, where you can:
 - adjust feathering parameters based on the selection in the window below.
 - turn Feather on or off per selection.



Image 7-5

(Optional) Delete Destinations

1. Click on the blue button **Delete Destination(s)**.
2. From the Name list click on the "x" space next to the output(s) you wish to delete.
3. Hit the red button **Delete Destination(s)** button. All of the selected Destination(s) will be removed from the list.

7.15 Configuration Menu > Layer optimization

General

In this procedure, the usage of Layers inside the EMP will be elaborated.

Prerequisite

- Ensure that you are familiar with the **Configuration Menu**. For details on this menu, please refer to chapter "Configuration Menu", page 106, as well as previous chapter.

Layers in an Event Master Processor

In the system there are banks of Video Processing Units, VPU's. These VPU's service the total output raster with layer resources. So 1, 4 or 8 outputs have the same number of layers to use as PIPs as the Mixing Background Layer is on top of this.

The VPU's have a bandwidth setting that allow for a certain size of Resolution to enter the VPU and get scaled. Currently we have SL / DL and 4K as settings allowing for mx 2048 x 1200 / 2560 x 1600 / 4096 x 2400 respectively.

The higher the resolution, the higher the bandwidth of the input and output of the scaler, or as we call it, number of Links. (This can be found in the Aux Scaling settings too where the highest setting is 8L, allowing for 8 Links of 2K resolution).

Here is an important difference from other systems, an EMP only scales the number of available layers based on the inputs size, not the output size as long we are inside a maximum of a 4K or 10MP output. Once passed the 10MP (MegaPixel), resources have to be added.

The S3-4K has only one bank of VPU's with 4 x 2K capable layers, is within 10MP and have none of the below described behavior.

Layer Optimization

E2 has several Banks of VPU's and has up to 16 x 2K capable layers available for Destinations. The layers can be assigned freely between the created Destinations.

However there is a few rules that came with freeing up the banks to allow "up to 16 layers" since the 1.5 software:

- Up to 4 outputs can use 16 mixing layers
- Up to 2 x 4 outputs can use 8 mixing layers EACH

We do this in order to allow as many layers to available to set ups and to be as flexible in use as the infrastructure allow.

7.16 Configuration Menu > Add Aux Destinations

General

In this procedure, you will Add Aux Destinations from the defined outputs.

Prerequisite

- Ensure that you are familiar with the **Configuration Menu**. For details on this menu, please refer to chapter "Configuration Menu", page 106



If more than one Aux Destination is utilized, repeat the below steps until all Destinations are added.

Add Aux Destinations

1. Click on the **Destination** tab to define destinations for the defined outputs.
2. From the diagram area click on the output that you want to be part of the destination.
3. Click on the **+Add Aux Destination** blue button to assign the output to the Aux destination.
4. When the destination is created a box appears next to the E2 diagram.

(Optional) Edit the Name

1. Double click on "Destination1" in the Name list to edit the name.
2. When the area turns blue, click the eraser icon to clear the field.
3. Type a new name and hit enter when done.

(Optional) Adjust Destination Parameters

Click on the "Adjust" tab that is located on the top. In this Tab there are three sub tabs: Assign, Output and Wide (See below).

(Optional) Adjust Destination Parameters part 1 > Assign Tab

From this menu you can:

1. Edit the name.
2. Change the Destination from Screen to Aux.
3. Set the dimensions if more than one connector.
4. Delete outputs.
5. Select the Auxiliary Scaling Capacity:

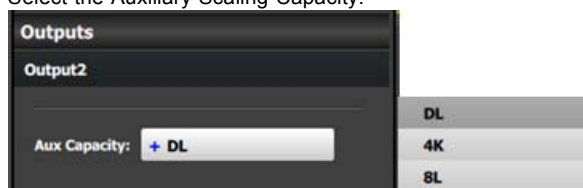

Aux Capacity defines how much resolution, or actually LINKs of data can be inserted into the scaler. Standard setting is DL and refer to Dual Link as in connector capacity while 4K is the same as 4Links it also refer to the total of the 4K resolution that can be entered. 8L refer to 8 Links of 2K data.

Each of the settings will allow for different size input / still and destination sources from the Input Resource tab covered in the Programming Section below.

DL = Max 2560 x 1600 or 4095 x 1200

4K = Max 4096 x 2400 or 8192 x 1200

8L = Max 8192 x 2400 or 16384 x 1200

(Optional) Adjust Destination Parameters part 2 > Output Tab

From this menu you can:

1. See the output canvas (raster) size if more than one connector in the connector group used for the Aux
2. Choose more actions in sub tabs:



- Position:
 - o Enable Test Patterns with raster box and enable diagonal motion
 - o Define the Area of interest (AOI).

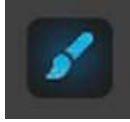

- Color:
 - o Perform color adjustments.



- Timing:
 - o Read the timing parameters associated with the selected format. Once a connector is in a connector group, its Timing Parameters cannot be changed in the Destination



- Connector Settings:
 - o Select SDI type and SMPTE standards.
 - o Adjust the Connector Mapping from Horizontal to Vertical or Grid. For outputs bigger than 4K a X by X dialog will be introduced

(Optional) Adjust Destination Parameters part 3 > Wide Tab

From this menu you choose between the two sub tabs:

- **Datadouble**, where you can adjust data Doubling parameters.
- **Feathering**, where you can:
 - adjust feathering parameters.
 - turn Feather on or off per selection.

(Optional) Delete Destinations

1. Click on the blue button **Delete Destination(s)**.
2. From the Name list click on the "x" space next to the output(s) you wish to delete. Or select the box to the right of the EMP representation in the workspace.
3. Hit the red button **Delete Destination(s)** button. All of the selected Destination(s) will be removed from the list.

7.17 Configuration Menu > Add MVR Outputs

General

In this procedure, you will add MVR Outputs to the system.

Prerequisite

- Ensure that you are familiar with the **Configuration Menu**. For details on this menu, please refer to chapter "Configuration Menu", page 106

Add MVR Output

1. Click on the **MVR** tab to select the outputs that will be defined.

Auto create MVR Outputs

Auto create MVR Outputs is pressed to create the two available MVR outputs.



The MVROut1 and 2 have a Unit ID, which is the same as the actual unit, it is there to allow selection in linked scenarios.

(Optional) Edit the Name

1. Double click on default name in the Name list to edit the name.
2. When the area turns blue, click the eraser icon to clear the field.
3. Type a new name and hit enter when done.

(Optional) Adjust Output Parameters

Click on the **Adjust** tab that is located on the top. The output adjustment panel is divided in three sections (Main, Timing, Connector). In the Adjustment panel you can:

1. [Main tab] Auto Configure Output Format function is not available for MVR at this time.
2. [Main tab] Edit the name.
3. [Main tab] Select Format value and Frame Rate.
4. [Main tab] Enable Test Patterns with raster box and enable diagonal motion.
5. [Timing tab] Read all timing parameters associated with the selected format and make adjustments. Adjustments are limited to the formats that can be pre-selected.
6. [Connector tab] Select HDMI Sync standards.
7. [Connector tab] Select Color space and Sample bit depth available as reported from the EDID of the Device.
8. [Connector tab] Select HDCP Mode for Multiviewer outputs.
The default for HDCP Mode is Off. To turn On the HDCP Mode, click on the empty HDCP Mode checkbox. When the checkbox displays a check mark, HDCP Mode is On. HDCP Mode is not applicable to SDI outputs.

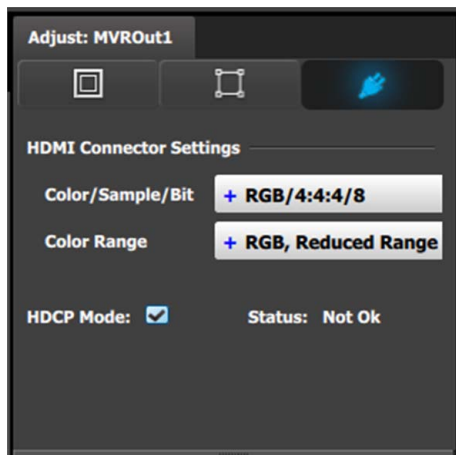

Image 7-6
Adjust tab: Connector Settings subtab



Only a few formats are available for the MVR Outputs as it is not a Program Output



Only Destinations with the same frame rate will be possible to add to the MVR output. More details on this topic in the Help File in your Event Master Processor.

(Optional) Delete Outputs

1. Click on the blue button **Delete MVR Output(s)**.
2. From the Name list click on the "x" space next to the Output(s) you wish to delete.
3. Hit the red button **Delete Output(s)** button. All of the selected Outputs will be removed from the list.

7.18 Programming Menu > Capture Stillstore from Inputs & Backgrounds

General

In this procedure, you will capture the inputs or background inputs as a Stillstored image.

Prerequisite

- Ensure that you are familiar with the **Programming Menu**. For details on this menu, please refer to chapter "Programming Menu", page 173.

Captured Stills are used as thumbnails in general in the interface once they are used in a layer or destination.

Capture Stillstore (Stills)

1. Click on the Background or input tab on the top of the left hand side.
2. Click on the Camera icon, the icon changed to a crossed over version and the input is captured into memory.



Image 7-7

3. The Still Store is now available in the Stills tab of the Input Resource tab.

Capacities and limitations

As a reference 100 still stores of 2K resolution can be stored, if the size of the still is bigger, the memory allocation increases allowing for less number of stills. Image can be imported as described in the Operation Section below.

Still Stores can be used in Backgrounds and Layers, but will need to be added from the right section in the Input Resource tab.

7.19 Programming Menu > Select Thumbnails for Backgrounds

General

In this procedure, you will add select thumbnails for the Background Sources.

Prerequisite

- Ensure that you are familiar with the **Programming Menu**. For details on this menu, please refer to chapter "Programming Menu", page 173.

(Optional) Update thumbnails from the PC memory

1. Click on the **Background** tab on the top of the left hand side.
2. Click on the thumbnail icon.



Image 7-8

3. Click in the black box next to input name.
4. Navigate the computers file system to find and select the desired thumbnail to be used Select Thumbnails from the PC memory.

Characteristics and limitations

Images need to be JPG, PNG, BMP or GIF format.

7.20 Programming Menu > Select Thumbnails for Inputs

General

In this procedure, you will add select thumbnails for the Input sources.

Prerequisite

- Ensure that you are familiar with the **Programming Menu**. For details on this menu, please refer to chapter "Programming Menu", page 173.

(Optional) Update thumbnails from the PC memory

1. Click on the **Input** tab on the top of the left hand side.
2. Click on the thumbnail icon.



Image 7-9

3. Click in the black box next to input name.
4. Navigate the computers file system to find and select the desired thumbnail to be used Select Thumbnails from the PC memory.

Characteristics and limitations

Images need to be JPG, PNG, BMP or GIF format.

7.21 Programming Menu > Create Sources from Inputs

General

In this procedure, you will create source files from the Input sources original source file.

Prerequisite

- Ensure that you are familiar with the **Programming Menu**. For details on this menu, please refer to chapter "Programming Menu", page 173.



When an Input is created, the software copies the Input to a source. More sources can be created by following the steps below.

(Optional) Create additional sources

1. Click on the **"Input"** tab on the top of the left hand side.
2. Click on the List icon.



Image 7-10

3. Click on the arrow next the Input name.
4. To copy the raw original source file click on the **PLUS** in the Input.
5. To copy the source click on the copy icon. This creates a copy of the Source including changes made and saved.

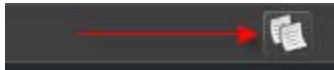

Image 7-11

(Optional) Rename the Source name

1. Click on the **"Input"** tab on the top of the left hand side.
2. Click on the List icon.
3. Click on the arrow next the Input name.
4. Double-Click on the Source name that you wish to rename.
5. Type the new name in the blue box.

7.22 Programming Menu > Drop backgrounds into Screen Destinations

General

In this procedure, you will drop backgrounds into Screen Destinations.

Prerequisite

- Ensure that you are familiar with the **Programming Menu**. For details on this menu, please refer to chapter "Programming Menu", page 173.

Drop Backgrounds

1. Click on the "Background" tab on the top of the left hand side.
2. Click on either the thumbnail or list icon.



Image 7-12

3. Click in the thumbnail area, even if it is black, or the listed name and drop it into the destination.

7.23 Programming Menu > Drop Sources, Layers into Screen Destinations & Sources into layers

General

In this procedure, you will drop sources and Layers into Screen Destinations & Sources into layers.

Prerequisite

- Ensure that you are familiar with the **Programming Menu**. For details on this menu, please refer to chapter "Programming Menu", page 173.

Drop Sources into Screen Destinations

1. From the top of the Resource Pane to the left select INPUT. Choose from the available Source types:
 - a) Input
 - b) Stills
 - c) Destination
2. Drag and drop any of the available resources into a Destination. When dragging and dropping a PNG with a transparency:
 - a) Drag the PNG to a Layer in a Destination.
 - b) Select the "Both" option in the Cut + Fill prompt. The system detects the transparency as the "Cut" signal and the non-transparent portion of the image as the "Fill" input.



Input Sources work only with Layers and Auxes, and Background Sources work only for Backgrounds.

Advanced Layer management in Screen Destinations

1. From the top of the layout area click on the screen destination that you wish to add layers into.
2. On the right hand side click on the Layers tab.
3. Click on the arrow next to the Destination name to reveal all the layers and background that were assigned to the destination.
4. Drag Layer1 into the preview screen. A black square box will appear.
5. Select the layer (black box) and then click on the **Adjust** tab on the top.
6. Select the "**Window Adjustment**" icon and then unlock the aspect ration lock by clicking in the **lock** icon.
7. Adjust the sizing parameters according to the size and position you want the layer to assume.



As the layer menu allow to hide and show the layer representation in the workspace it is an effective way to select layers if they are hidden or outside of the workspace.

(Optional) Adjust Layer Parameters

With a Layer Selected click on the Adjust tab that is located on the top. All layer related adjustments can be reached here.

1. Select the layers type, PIP (Standard) or KEY
2. Add Keyframes (See below).
3. Set the transition rate for the layer. 30 is standard and is in frames based on the Native Frame rate.

(Optional) Adjust Layer Parameters > Main submenu

With the Layer Main submenu you can:

1. Set border to any of the available versions, including Off.
2. Manipulate the border Width and Color.
3. Enable the Shadow and adjust its Sizing and Color parameters.

(Optional) Adjust Layer Parameters > Window Adjustment submenu

With the Window Adjustment submenu you can:

1. Adjust the size of the layer either with direct numerical entry, slider or + and – actions
2. Adjust Mask of the layer. This has in the past been called crop.

(Optional) Adjust Layer Parameters > Layer Effects submenu

With the Layer Effects submenu you can:

1. Activate and Adjust Strobe effect for the layer.
2. Activate and Adjust Flip effect for the layer.
3. Activate Freeze effect for the layer. This also have a shortcut in the bottom of the workspace.
4. Activate and Adjust Color Effects for the layer.
5. Activate Monochrome effect for the layer.
6. Activate Invert effect for the layer.



If the Layers are supposed to toggle between Preview and Program, click the Toggle button in the top of the Destinations Preview.



A source can be dropped into the Program of an Aux if the Program is Un-Locked. Un-lock the Program by clicking on the small white lock in the bottom of the Destination.

(Optional) Key Frames

Click on the **Adjust** tab that is located on the top.

1. Select the layer you want to create the Key Frame.
2. Place the layer at the initial position and size.
3. Click the Blue "**Add KF**" button to create a new keyframe.
4. Move the layer at the end position and size.



Now the END state is saved only. The layer can move between the two states by clicking on the green arrows. To execute the effect you now select the button ARM in the bottom of the workspace.



Keyframe will move the layer from the layers current position in Program to the Keyframed END position. This allows re-using keyframe moves and other effects from ANY Preset as long as they are on the right layer.



Now you are ready to execute the presets and transition on the desired preview look into Program. Remember to select the corresponding destinations when you use the Trans All button.

7.24 Programming Menu > Drop Inputs to Aux Destinations

General

In this procedure, you will drop Inputs into Aux Destinations.

Prerequisite

- Ensure that you are familiar with the **Programming Menu**. For details on this menu, please refer to chapter "Programming Menu", page 173.

Drop Layers into Screen Destinations

1. Make sure the Aux Destination is visible in the workspace by selecting the proper layout or view.
2. On the left hand side click on the Inputs tab.
3. Drag any Input Source into the preview screen of the Aux destination.

(Optional) Additional Adjustments

1. If the Aux is supposed to toggle between Preview and Program, click the Toggle button in the top of the Destinations Preview
2. A source can be dropped into the Program of an Aux if the Program is Un-Locked. Un-lock the Program by clicking on the small white lock in the bottom of the Destination.

7.25 Programming Menu > Presets And User Keys

General

In this procedure, you will drop sources and Layers into Screen Destinations & Sources into layers.

Prerequisite

- Ensure that you are familiar with the **Programming Menu**. For details on this menu, please refer to chapter "Programming Menu", page 173.

(Optional) User Keys

Click on the Adjust tab that is located on the top.

1. Click on the User Keys tab.
2. To create a user key, first select the layer parameters you wish to save to a user key: Type, transition, Effects, Border, Shadow, Key, Position, Size, Source and Mask. All or None can be selected with the checkbox.
3. Click on the Save to new user Key button.
4. If desired, click on the User Key name to edit the name.
5. If desired click on the Number to edit the number. It can be any number with XXX format up to 300.
6. You can override the same user key by clicking on the name box and then select the Overwrite User Key Button.
7. All of the User Keys are sequentially numbered. A specific preset can be found by typing the number in the first gray box next to "#". Immediately the respective preset will be highlighted and ready for further actions.
8. The box with the magnifying lens icon allows for a text string search. For example by typing "4by3", it will return all User Keys with the "4by3" part of its name.
9. User Keys can be applied to layers in a drag and drop fashion.
10. If there are several layers selected they can all get the same User Key applied by using the Apply Selected (User Key) Button in the bottom of the List.

(Optional) Presets tab

Click on the Adjust tab that is located on the top.

1. Click on the Presets tab.
Before creating a Preset...
 - a) Select the desired creation option from the Creation Option drop-down list.
 - b) Show or hide Layers or Backgrounds as desired for Relative Presets.
2. To create a new preset first click on the Save From PVW button or Save From PGM button. It will save the selected Destinations Preview set up or Program Respectively.
3. If desired, click on the Preset name to edit the name.
4. You can overwrite the same Preset by clicking on the name box and then select the Overwrite From PVW or Overwrite From PGM button. It will save the selected Destinations Preview set up or Program Respectively.
5. Any Preset can be deleted by first clicking on the Delete Preset(s) blue button.
Then select the Presets desired to be deleted and click on the red Delete Selected.
6. Presets can be re-ordered via the Enable Reorder button who opens the List for Drag and Drop re-order.
7. You can execute presets and navigate through the stored presets by clicking one of the three buttons at the bottom in this section: Recall Previous, Recall Current and Recall Next.
8. If the presets should go live directly on re-call the Preset To PVW button in the bottom can be clicked and turned into Red Preset To PGM thus altering the functionality of the re-call.
9. All of the presets are sequentially numbered. A specific preset can be found by typing the number in the first black box next to "#". Immediately the respective preset will be highlighted.
10. The box with the magnifying lens icon allows for a text string search. For example by typing "Cam", it will return all presets with the "Cam" part of its name.
11. Presets can be locked from accidental deletion by activating the small blue lock to the right in the name area of each preset.
12. Any preset can be re-numbered in the format of XXX.XX but a maximum of 1000 presets is still only possible.
13. Presets can be applied to Preview in a drag and drop fashion.

7.26 Programming Menu > Destination Transition

General

Any selection of Destinations or Destination Groups can be transitioned. It is done by selecting the Destinations name tab in the top of the Preview area of the workspace. This selection is also recorded into Presets and recalled with them.

Procedure

1. Select the Preview destination screen to transition to program.
2. By clicking the All Trans or Cut button all of the selected Preview screens will be transitioned to Program.
3. You can select background to be transitioned to program by clicking on the background button next to the Screen name in the preview area.
4. The Destination transition resolve can follow different curves in order to better match camera brightness or after preference. Default is S-Curve.
5. Time of the Transition is set in frames of the Native Frame rate and is recorded in Presets.



Time Per Destination CAN be set, but only one at the time.

7.27 Multiviewer Menu > Drop Inputs, Backgrounds and Destinations



Make sure that you have assigned connectors to MVR outputs before you proceed.

General

In this procedure, you will setup the Multiviewer outputs to the MVR monitors..

Prerequisite

- Ensure that you are familiar with the **Multiviewer Menu**. For details on this menu, please refer to chapter "Multiviewer (MVR) Menu", page 216.

Drop Inputs, Backgrounds and Destinations into Multiviewer windows

We will setup the top window to display all the inputs and the bottom window to display the Program and preview screens.

1. Click on the Multiviewer icon on the left hand side of the screen.
2. Click on the top tab that is labeled "Source" and drag the desired sources to view into the multiviewer window .
3. Click on the top tab that is labeled "Background" and drag the desired backgrounds to the multiviewer window.
4. Click on the top tab that is labeled "Destination" and drag the desired Destination to the multiviewer window.

(Optional) Color Adjustments

Click on the **Adjust** tab that is located on the top.

1. For each or multiple multiviewer windows you can perform color adjustments for the borders, UMD and multiviewer background .

(Optional) Auto Layout Input

Click on the **Adjust** tab that is located on the top.

1. Alternatively, to selecting sources individually to drag them into the multiviewer window, drop all of the sources simultaneously. Click on the **Auto Layout Input** button that is located at the bottom of the display area. All of the sources will appear lined up at the top of the window.

(Optional) Source Preview

Click on the **Adjust** tab that is located on the top.

1. Select the layer you want to preview full screen.
2. Click on the Source preview button at the bottom menu area.

8. UPDATING FIRMWARE

About this chapter

This chapter provides a detailed procedure for upgrading Event Master series processor software (firmware).

The Event Master series processor provides two options for upgrading firmware via the front panel menu:

- Using the USB port on the front panel.
- Using the Web Upgrade.



A third solution is available to upgrading the Event Master series processor with the built-in web interface. For details on the upgrade procedure via the Setting Menu in the Event Master Toolset Software (EM GUI), please refer to chapter "Settings Menu > Web App area > Tools > Manage Software", page 236



In the event the Event Master series processor gets into a state in which it constantly reboots after a software upgrade, press and hold the SEL and ESC keys simultaneously until the front panel shows the choice of performing a factory reset or continuing. Performing a factory reset will allow the Event Master series processor to boot normally.

Overview

- Upgrading firmware using the USB port
- Upgrading firmware using the web Upgrade

8.1 Upgrading firmware using the USB port

Necessary tools

USB drive (Not supplied by Barco) formatted in FAT32.

How to upgrading firmware

1. Ensure that your flash drive is formatted to use the FAT32 file system. If necessary, reformat the drive as described in the following section "Formatting the flash drive".
2. Prepare the flash drive with the upgrade file as describe below in the section "Preparing the flash drive with the upgrade file"
Note: *Upgrading software with the USB port requires the "em_update_vp.xx.xx.tar.gz" file to be within a directory named EM (or E2).*
3. When the drive is ready, refer to the chapter "Performing the firmware upgrade using the USB" describe below for the upgrade procedure.



CAUTION: Reformatting the flash drive erases existing data. To avoid losing data, download to a computer or a secure site any files you wish to keep, then format the drive.

Formatting the flash drive

1. Insert the flash drive into a Windows PC or laptop's USB port.
2. Select a Windows Explorer or a panel allowing an overview on the disk drives and the hardware connected to your computer (e.g. **Start > Computer** on Windows 7 or **Start > My Computer** on Windows XP).
3. On this view, right-click the drive that represents the flash drive.
4. Select **Format** from the menu that appears.

The Format Disk screen appears.

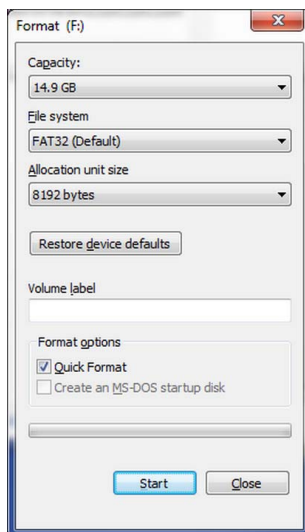

Image 8-1
Format Disk screen

5. Select **FAT32** as the file system, and **Quick Format** under **Format Options**, as shown above in the Format Disk screen illustration.
6. Click **Start**.
A message appears, warning that data will be erased during the formatting process.
7. Click **OK** to continue.
A confirmation message appears after a few seconds. The flash drive is now ready to use



Upgrading software with the USB port requires the "em_update_vp.xx.xx.tar.gz" file to be within a directory named EM (or E2).

Preparing the flash drive with the upgrade file.

1. Download the software upgrade for free from Barco's website (URL: <http://www.barco.com>). Click on **myBarco** and login to get access to secured information. Registration is necessary.
Note: *If you are not yet registered, click on **New to myBarco** and follow the instructions. With the created login and password, it is possible to login where you can download the Event Master series processor software. It is not necessary to install any other software.*
2. Unzip directly the software upgrade downloaded from the Barco website to the USB drive. This operation automatically creates a directory named EM (or E2) with the upgrade file inside (em_update_vp.xx.xx.tar.gz).

Performing the firmware upgrade using the USB

1. Insert the flash drive into the unit's USB port.
2. Select **Firmware Upgrade** from the Setup Menu. The **Firmware Upgrade** submenu appears.



Image 8-2

3. Select **USB Code Upgrade**. The menu shown in the following illustration appears.

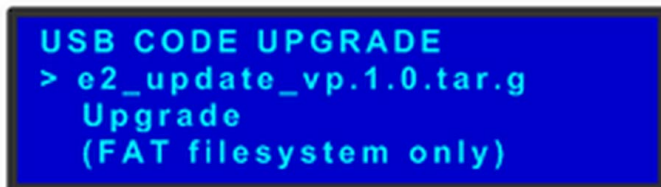

Image 8-3

4. Scroll to the file you want to use, and press **SEL**.
5. Scroll to Upgrade and press **SEL** again.
A progress message appears.
6. When the file is loaded, the unit powers down and reboots.



CAUTION: Do not remove the flash drive or power down the Event Master series processor until the firmware file is uploaded.

8.2 Upgrading firmware using the web Upgrade



The upgrade operation begins with a step of validation to check if a new version is available.

How to upgrading firmware

1. Verify that the Event Master series processor has internet access. Contact your system administrator if necessary.
2. Select **Setup > Firmware Upgrade > Web Upgrade**. The submenu shown in the following illustration appears.



Image 8-4
Web Firmware Upgrade Submenu

3. Select **Check**.

A message informs you if a new firmware version is available.



Image 8-5
Firmware Version-Upgrade Message

Or,

If during the "Check" process new firmware is NOT detected, the following message will show:



Image 8-6
No Firmware Available Message

4. Press **SEL** to start the upgrade. A message will inform the user to "Please wait..."

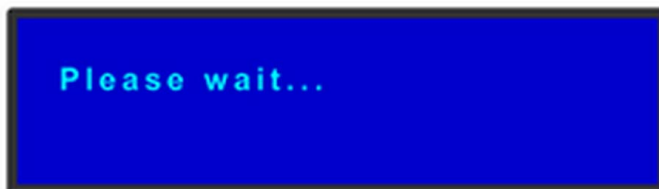

Image 8-7
Upgrade Wait Message

5. After the upgrade is finished, the unit will automatically reboot.



Image 8-8
Resetting Message



If you are not connected to the internet, a message prompts you to check the connection.

9. GENERAL OPERATION EXAMPLE

About this chapter

The application below is presented to demonstrate the basic E2 operation. The example provides the user a step-by-step setup and operation instructions in order to meet some specific event requirements.

Overview

- Event requirements
- Preliminary
- Control Software Operation
- Configuration Menu
- Programming Menu
- Multiviewer (MVR) Menu

9.1 Event requirements

Description

Inputs for the event are provided from a Windows PC, two AJA KiPROs file recorders, an Apple Macbook and two video cameras.

Several outputs are required as follows:

- Two program outputs for the projectors dedicated to the Main screen. Two PIPs are displayed that are equal in size and are side-by-side. Two looks are desired:
 - One look displays the two video clips simultaneously from the KiPROs.
 - The other look shows the PowerPoint and the stage camera.
 - Background will be provided from a PC dual-head card.
- Single Screen Site Screen: Displays the videos from two KiPROS and two cameras. The images are always full screen and transition on screen at 0.5 sec.
- A DSM monitor is required for camera adjustments.
- Two 2 monitors for multi-viewing.

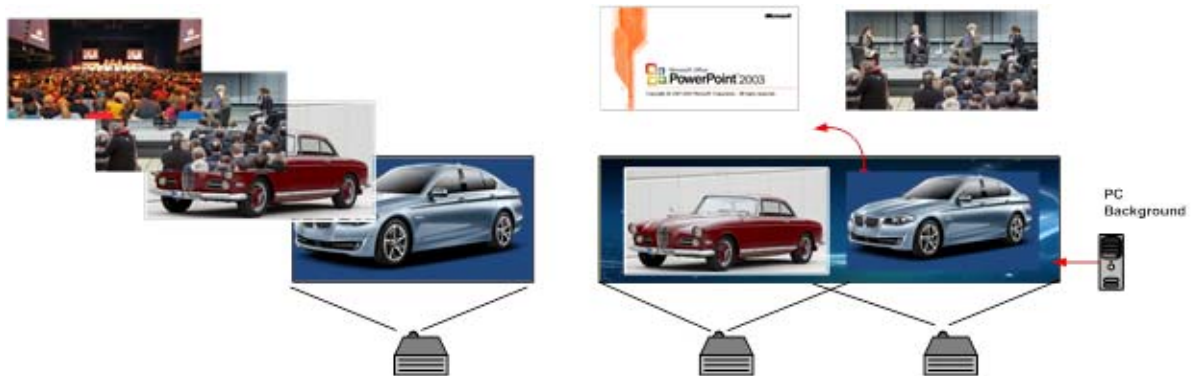

Image 9-1

9.2 Preliminary

Application Diagram

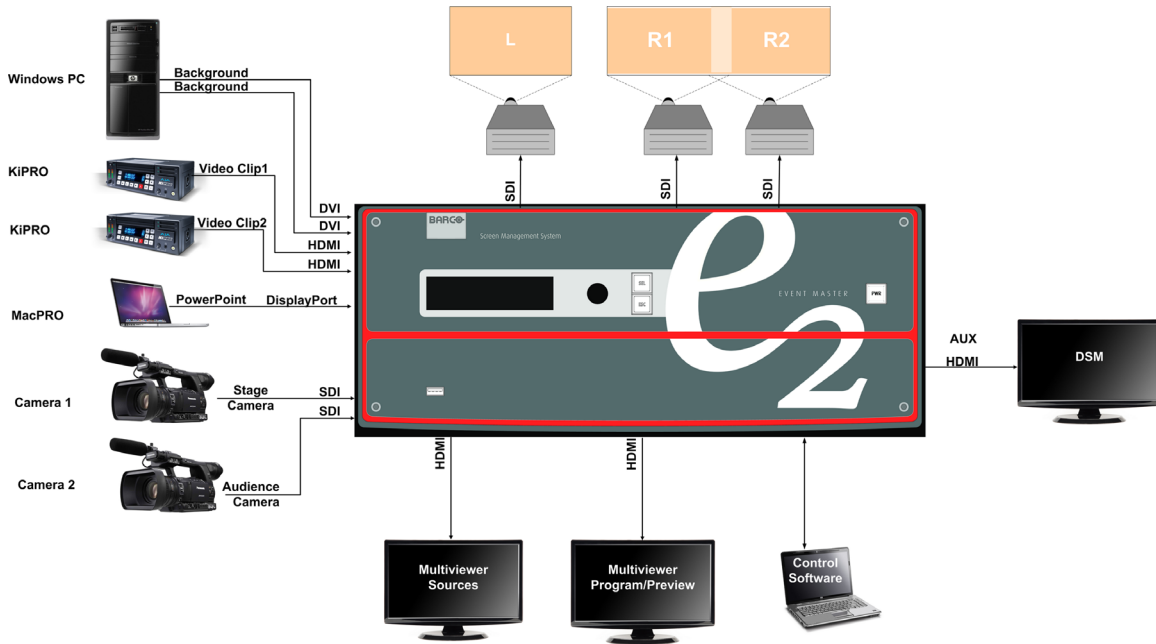

Image 9-2

wiring

Connect the input and output devices to the E2 as follows:

Signal Type	Device Name	Content	Connector Type	Slot-Connectors
Input	CAM1	Audience camera	3G-SDI	4-1
Input	CAM2	Stage Camera	3G-SDI	4-3
Input	PC	Background	DVI	6-1
Input	PC	Background	DVI	6-2
Input	KiPRO1	Video Clip1	HDMI	8-3
Input	KiPRO2	Video Clip2	HDMI	9-3
Input	MacPRO	Power Point	DisplayPort	10-1
Output (AUX)	DSM	DSM for cameras	HDMI	11-1
Output	Proj-L	Projector Left Screen	SDI	13-1
Output	Proj-R1	Projector Right Screen 1	SDI	13-3
Output	Proj-R2	Projector Right Screen 2	SDI	13-4
Multiviewer	MVR1	Program/ Preview Monitor	HDMI	14-1
Multiviewer	MVR1	Input Sources Monitor	HDMI	14-3

9. General operation example

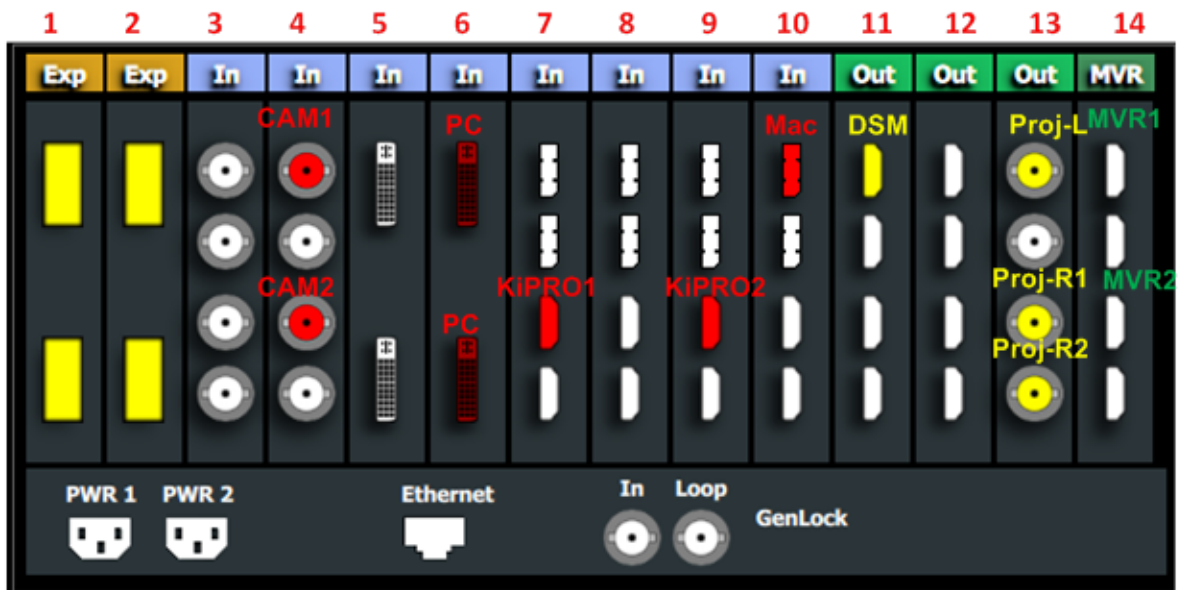

Image 9-3

9.3 Control Software Operation

Overview

In this section we will use the control software (Event Master Toolset Software) to setup the E2 and create presets and user keys to be used during the event. We will follow the steps sequentially outlined in diagram below.

Workflow Diagram

This diagram shows all the steps necessary to setup the system.

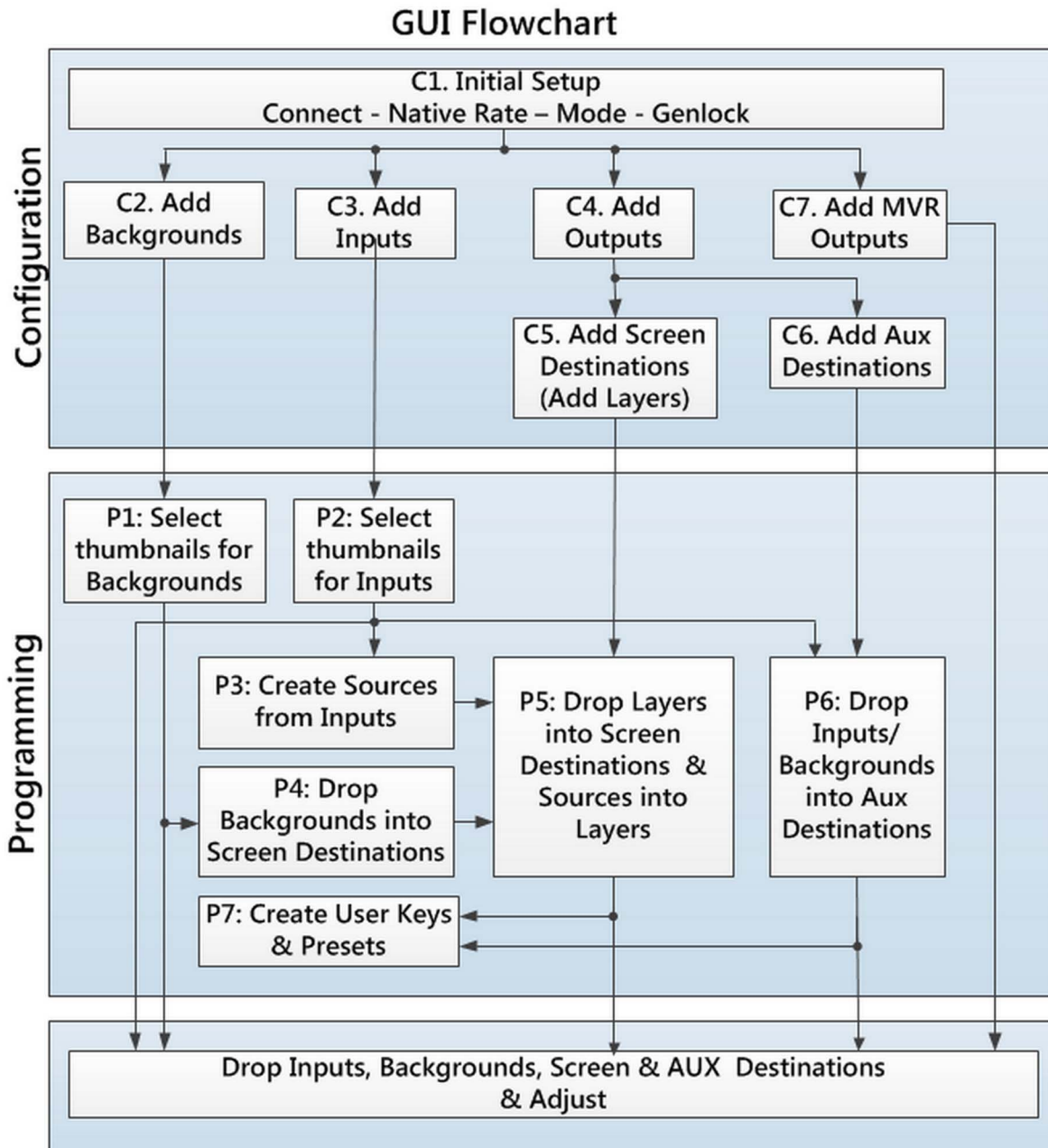

Image 9-4

Set up from A to Z

As outlined in the previous chapter the control software is divided in 3 parts:

1. **Configuration Menu.** In this section users define the system components like inputs, backgrounds, outputs and destinations. See the detailed procedure in section "Configuration Menu", page 290.
2. **Programming Menu.** In this page users create sources from inputs, drop layers and backgrounds into screens and create User keys and presets. See the detailed procedure in section "Programming Menu", page 295.
3. **Multiviewer (MVR) Menu** is the module used to setup the Multiviewer outputs (on one or two monitors). See the detailed procedure in section "Multiviewer (MVR) Menu", page 306.

9.4 Configuration Menu

Overview

Here, we define E2 components by adding inputs, backgrounds, outputs and destinations.

C1: Initial Setup

1. When you connect to an actual unit, instead of working offline, the software should connect automatically. The unit is listed in the System configuration page under the "Discovered" tab with the button on turning green.
2. Drop the E2 from the device area into the middle diagram area.
3. If multiple units are connected to the PC, the green LEDs next to the system name will turn green. You can assign a unique name to each unit. In this application we will connect to only one unit and assign the name "Godzilla" to it. For online operations, you can confirm that you are connected to the right unit by clicking the arrow in front of E2 to reveal the unit's IP address. Verify that this address is the same as the address listed on the unit's front panel on the top status menu

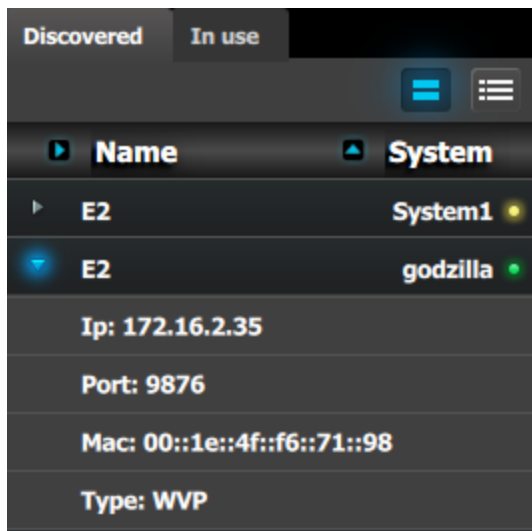

Image 9-5

Note: If the unit doesn't connect automatically to the PC, you can type the PC's IP address in the field under "Manual Connect".

4. For this application we will leave the default setting for Native rate: 59.94, Mode: 2K and Genlock: OFF.

C2: Add Background

1. Click on the "Background" tab to select the input that will be assigned as a background.
2. Click on the **+Add Background** blue button to enter the Add mode.
3. Click on the top DVI connector of slot 6 to select the input to define as background.
4. Click on the bottom DVI connector of slot 6 to select the input to define as background. We need to do this twice because the background comes from a dual-head DVI card.
5. Click on the **Done Adding** button to exit the Add mode.
6. Double click on **Background1** in the Name list to edit the name.
7. When the area turns blue, click the eraser icon to clear the field.
8. Type a new name, "PC-Background". Hit enter when done.

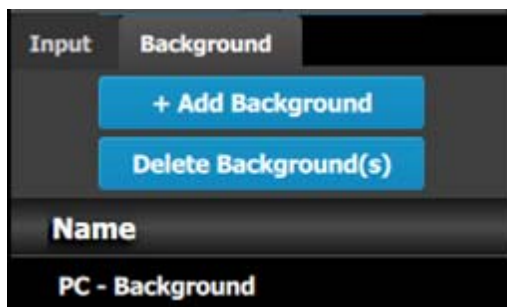

Image 9-6



In this application only one background is required, but in applications where more than one background is required, repeat steps 2 thru 6 until done.

C3: Add Input

1. Click on the **Input** tab to select the inputs that will be defined.
2. Click on the **+Add Input** blue button to enter the Add mode.
3. Click on the first SDI connector of slot 4 to defined as the camera 1 input.
4. Click on the **Done Adding** button to exit the Add mode.
5. Double click on **Input1** in the Name list to edit the name.
6. When the area turns blue, click the eraser icon to clear the field.
7. Type a new name: "CAM1-Stage". Hit enter when done.
8. Repeat steps 2 thru 6 until done. Enter the names as shown in the image below.

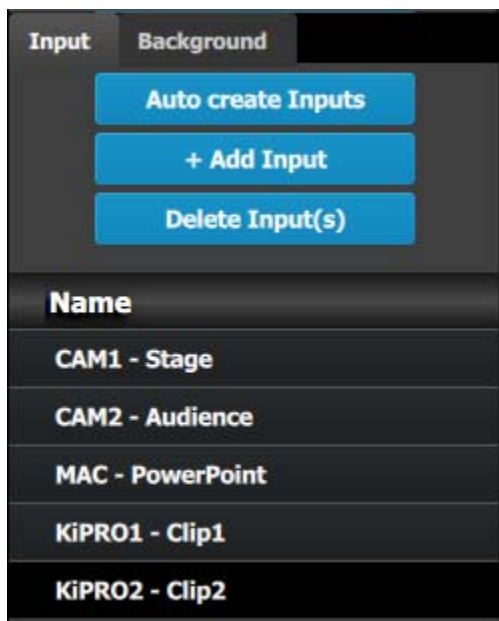

Image 9-7

C4: Add Output

1. Click on the **Output** tab to select the outputs that will be defined.
2. Click on the **+Add Output** blue button to enter the Add mode.
3. Click on the first HDMI connector of slot 11.
4. Click on the **Done Adding** button to exit the Add mode.
5. Double click on **Output1** in the Name list to edit the name.
6. When the area turns blue, click the eraser icon to clear the field and type a new name, "DSM". Hit enter when done.
7. Repeat steps 2 thru 6 until done to add the rest of the output connectors with the following names:
 - Site projector (SDI, Slot 13-1)
 - Main-Left Projector (SDI, Slot 13-3)
 - Main-Right Projector (SDI, Slot 13-4)

When you are done the menu should look like this:

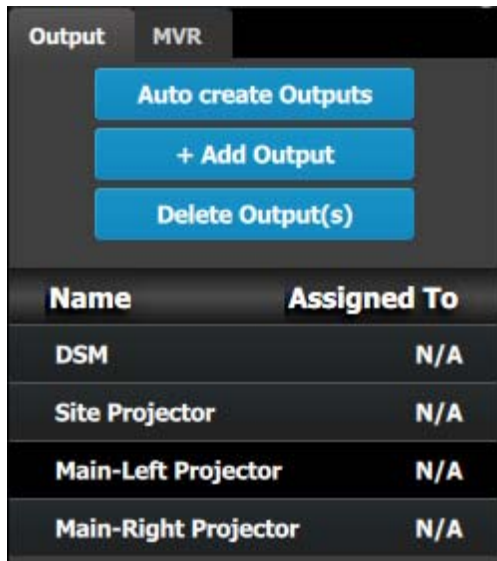

Image 9-8

Note: The "N/A" at this end refers to the destinations that will be added next.

C5 – Part1: Add Site Screen Destinations

In this section we will create the Site Screen Destination and assign two layers.

1. Click on the **Destination** tab to define destinations for the created outputs.
2. From the diagram area click on the first BNC of slot 13 that is the Site Projector output connector. The BNC will be highlighted.
3. Click on the **+Add Screen Destination** blue button to assign the output for the screen destination.
4. When the destination is created a box appears next to the E2 diagram.
5. Double click on the **Destination1** area in the Name list to edit the name.
6. When the area turns blue, click the eraser icon to clear the field and type a new name, "Site Screen".
7. Click on the top at the **Adjust:Site Screen** tab and in the **Assign** menu under the Output section click on the **+Assign Layer to Destination** blue button to assign a layer to the destination .
8. In the layout area "1 layer" will appear in the green area of the box.
9. Repeat the previous step to add one more layer.

C5 – Part2: Add Main Screen Destinations

In this section we will create the Main Screen Destinations and assign 3 layers.

1. To create the Main Screen destination, please repeat steps 2 thru 6 of the previous stage (C5–Part1) by first clicking on the "Main-Left Projector" BNC.
2. Rename the destination to "Main Screen".
3. After the destination is created, click on the "Main-Right Projector" BNC and drag it into the "Main Screen" destination box. The Screen size will immediately change to 3840x1080.
4. Repeat the same steps as above to add layer to the destination but click the add button 3-times to add 3 layers.

C5 – Part3: adjust the projector overlap in Main Screen destinations

In this section we will adjust the projector overlap area for the Main screen.

1. Under the Wide menu in the small diagram area shows the destination, click on the line between the two sites. The line turns blue.
2. Click on the **Data Double** button and enter "100" for the H overlap value. Note: We will leave the feathering to the default value of 2.2.

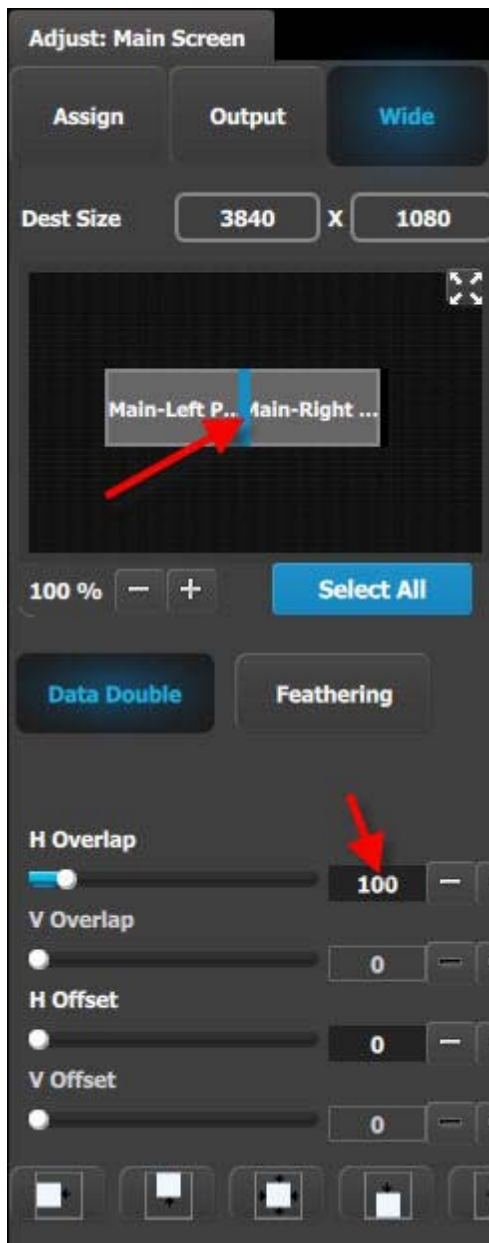

Image 9-9

C6: Add Aux Destinations

1. From the diagram area click on the DSM output. The connector will be highlighted.
2. Click on the **+Add Aux Destination** blue button to assign the DSM output to an Aux destination.
3. When the Aux destination is created a box appears next to the E2 diagram.
4. Double click on the **Destination1** area in the Name list to edit the name.
5. When the area turns blue, click the eraser icon to clear the field.
6. Type a new name, "DSM". Hit **enter** when done.

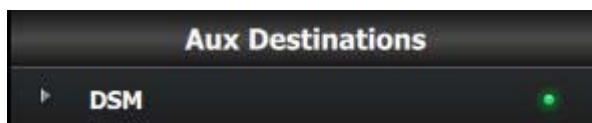

Image 9-10

C7: Add MVR Output

1. Click on the **MVR** tab to select the MVR outputs that will be defined.
2. Click on the **+Add MVR Output** blue button to enter the Add mode.

9. General operation example

3. Click on the first HDMI connector of slot 14 .
4. Click on the **Done Adding** button to exit the Add mode.
5. Double click on **MVROut1** in the Name list to edit the name.
6. When the area turns blue, click the eraser icon to clear the field and type a new name, "Sources". Hit enter when done.
7. Click on the third HDMI connector of slot 14 .
8. Click on the **Done Adding** button to exit the Add mode.
9. Double click on **MVROut2** in the Name list to edit the name.
10. When the area turns blue, click the eraser icon to clear the field and type a new name, "Program/Preview". Hit enter when done.

At this stage the layout section of the GUI should look like this:



Image 9-11

9.5 Programming Menu

Overview

The programming Menu is accessed by clicking on the Programming icon on the left hand side of the screen. The area in the middle will display a composite of the two screen destinations and the Aux destination created in the previous section.

We will assign layers and backgrounds into the screens, adjust sizing and positioning parameters, and finally, drop sources into the layers.

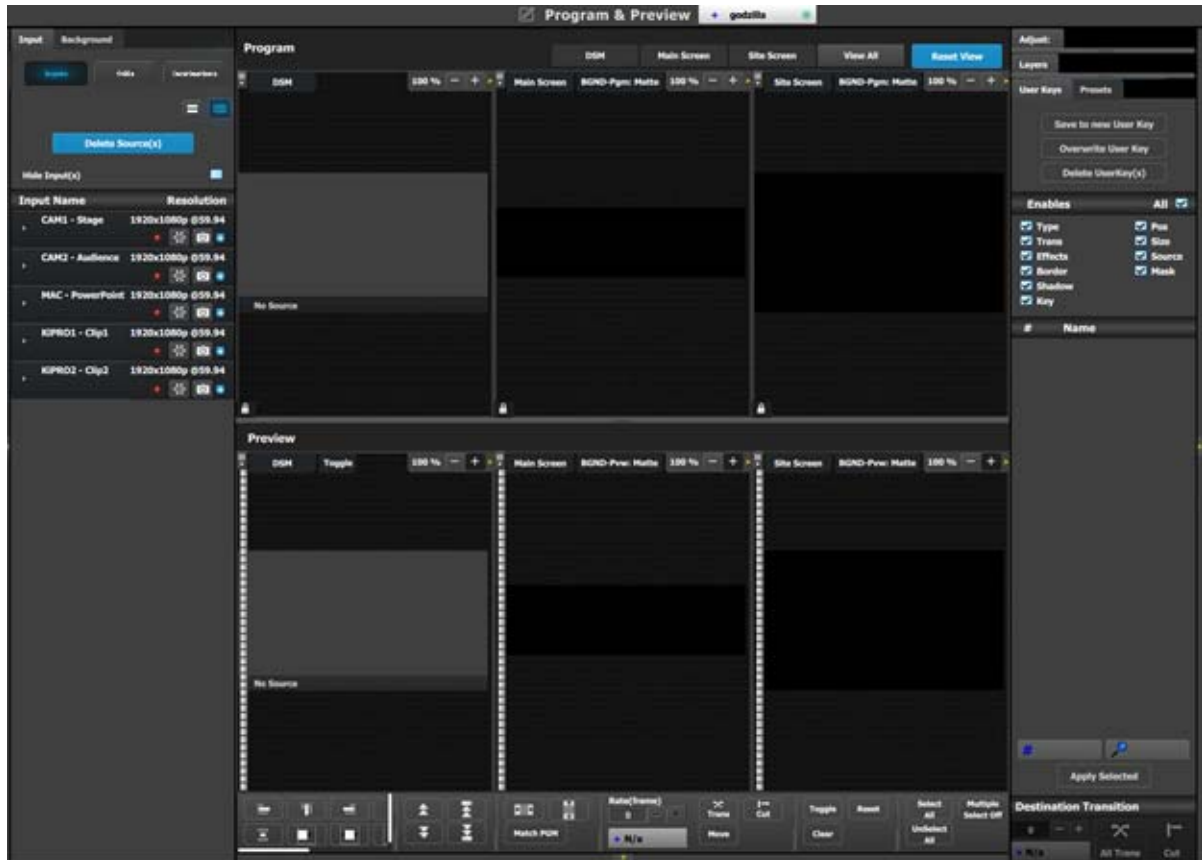

Image 9-12



P1: You can skip this step if you don't want thumbnail images to represent the background. In this case, the background in the destinations area will be black and noted only by the assigned name.

P1: Select thumbnails for Background.

1. From the left hand side, click on the **Background** tab.
2. In the Background menu, click on the **Background** tab.
3. Click on the **thumbnail** button.

9. General operation example

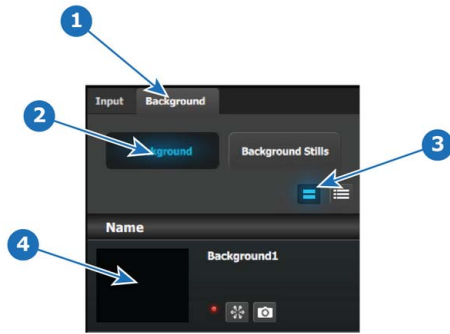

Image 9-13

4. Now, you can navigate the computer to select the desirable pic by clicking in the black square.
5. After a pic is selected, the image will fill the black square as shown below.

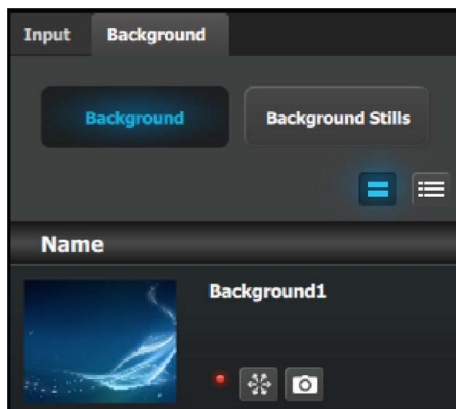

Image 9-14



P2: You can skip this step if you don't want thumbnail images to represent the inputs/sources. In this case, the layers in the destinations area will be black and noted only by the assigned name.

P2: Select thumbnails for Inputs

1. From the left hand side, click on the **Input** tab.
2. In the Input menu, click on the **Inputs** tab
3. Click on the **thumbnail** button.
4. Click in the black box and navigate the computer to find and select the desired pic.
5. After a pic is selected, the image will fill the black square.
6. Repeat this sequence until a pic is selected for each input.
7. When these steps are completed, the section will appear as follows.

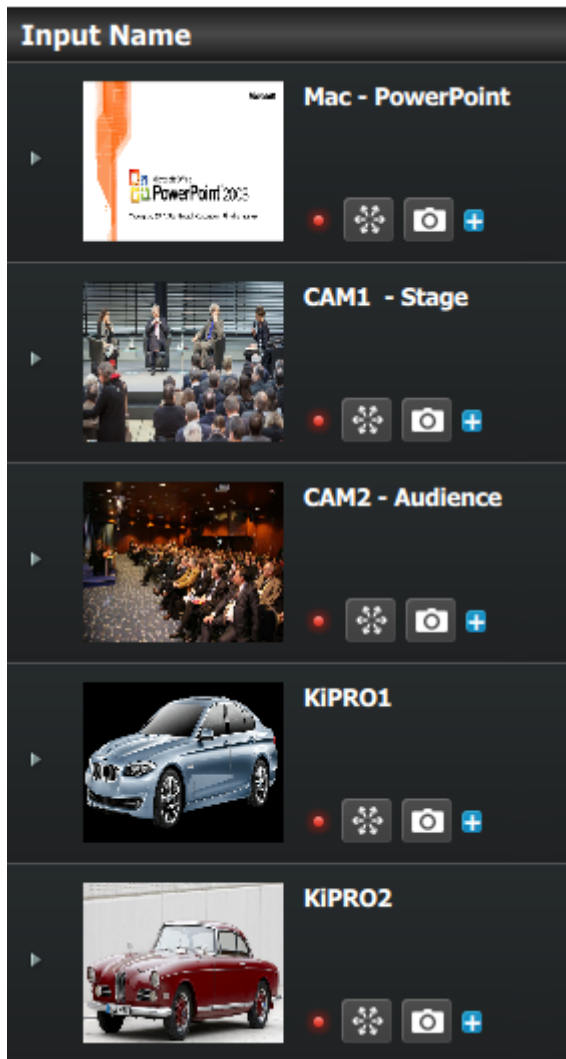

Image 9-15

P3: Created Additional Sources from Inputs



As noted previously, a source is generated automatically for each input. For this application, only one source will be used for each input, so no additional sources need to be created. Therefore, in this example this step will be skipped.

P4: Drop Backgrounds into Screen Destinations

1. On top click on the **Main Screen** tab to only view the Main Screen.
2. Select the Background tab from the top left side and drop it into the preview layer.

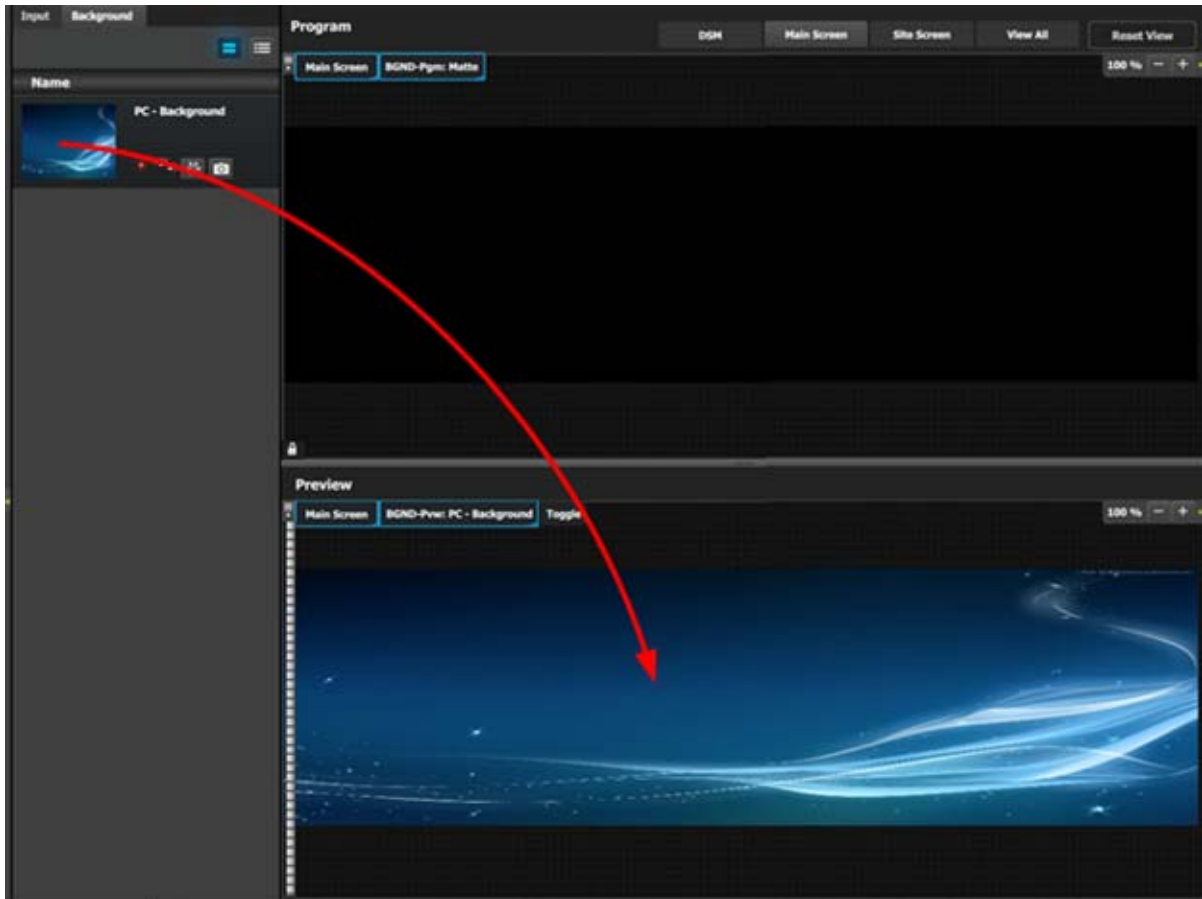

Image 9-16

P5: Drop Layers into Screen Destinations & Sources into layers

In this step we will add layers into each Destination, assign sources to layers and adjust their size and position parameters.

Part1: Site Screen

1. On top, click on the **Site Screen** tab to only view the Site Screen.
2. On the right hand side of the screen click on the **Layers** tab and then click on the arrow next to the Destination name to reveal all the layers and background that were assigned to the destination.
3. Drag Layer1 into the preview screen. A white square box will appear.

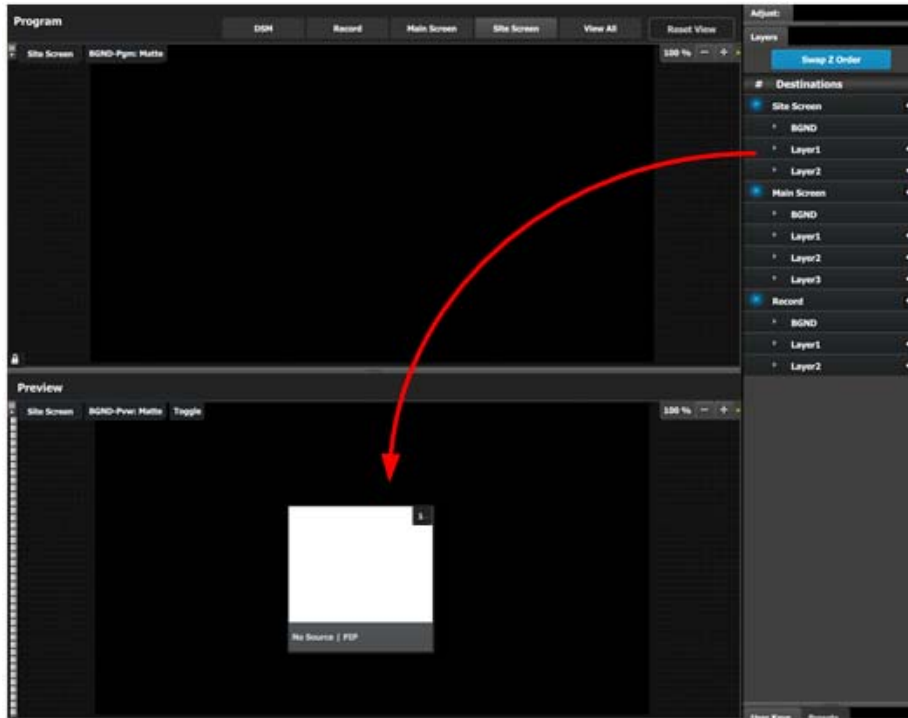

Image 9-17

4. Select the layer (white box) and then click on the Adjust tab on the top.
5. Select the **Window Adjustment** Icon and then unlock the aspect ration lock by clicking in the lock icon.

9. General operation example

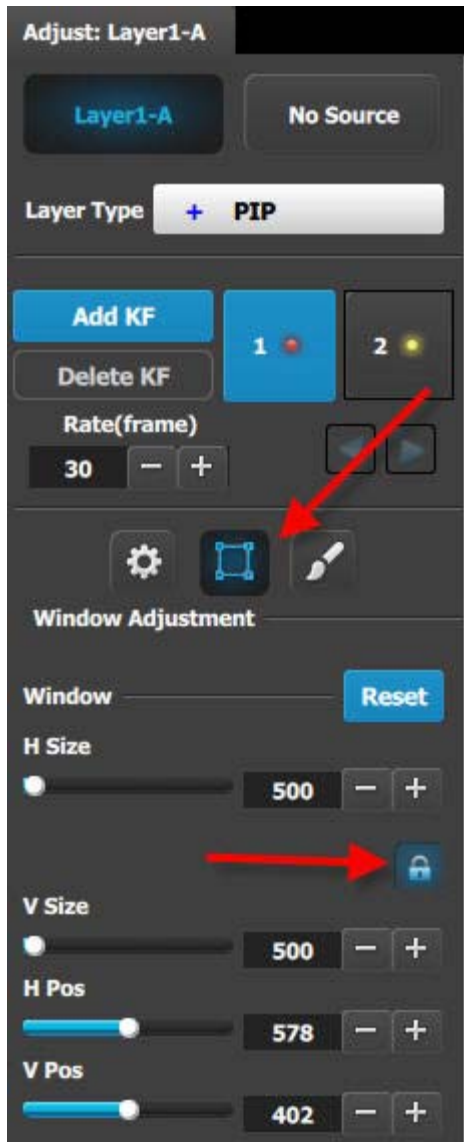

Image 9-18

6. Adjust the sizing parameters as follows:
 - a) H Size: 1920
 - b) V size: 1080
 - c) H Pos: 0
 - d) V Pos: 0
7. From the left hand side, click on the Input tab.
8. Click the source under CAM1 and drop it into the layer.

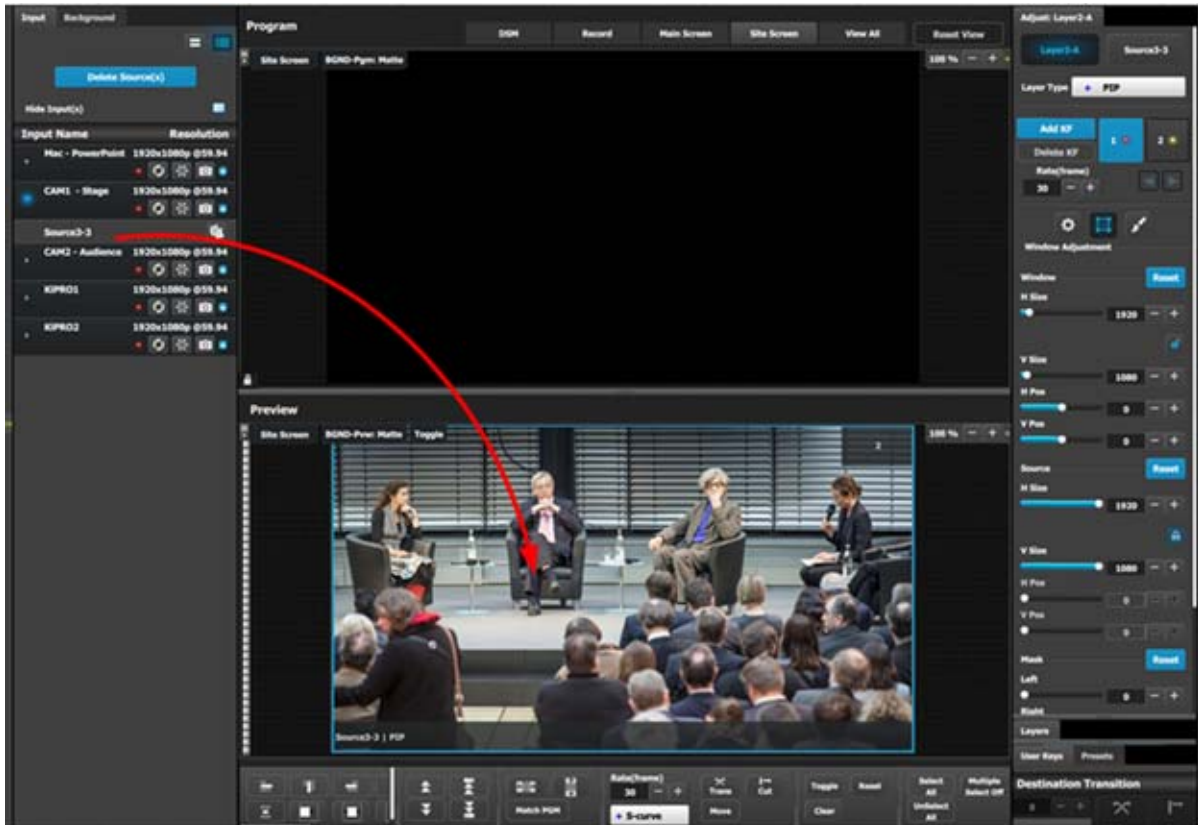

Image 9-19

9. Transition the layer to program.

10. Drop the source for CAM 2 to the preview layer.

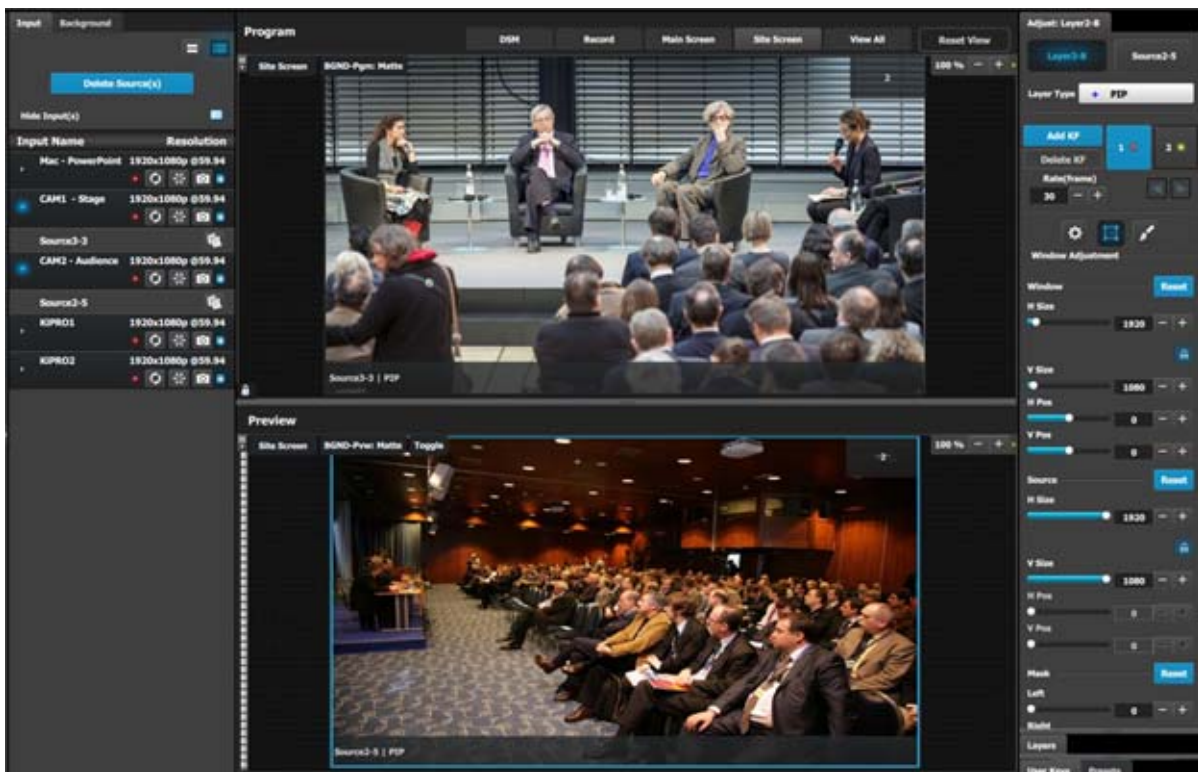

Image 9-20

Part2: Main Screen

1. On top click on the **Main Screen** tab to only view the Main Screen.
2. Under the **Layers** tab, click on the arrow next to "Main Screen".

9. General operation example

3. Drag Layer1 and Layers 2 anywhere into the preview screen. Two white square boxes will appear.

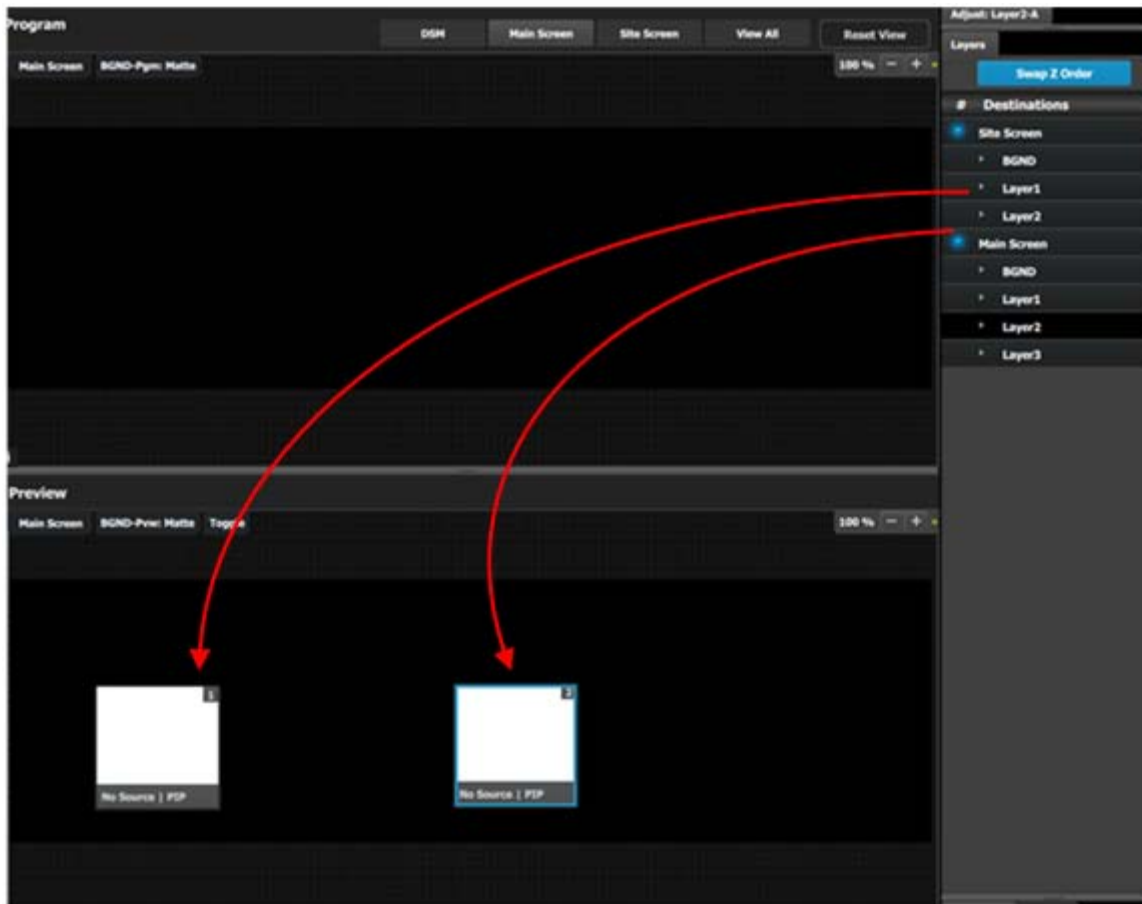

Image 9-21

4. Click on the Adjust tab on the top and select the "Window Adjustment" Icon.
5. Unlock the aspect ratio lock by clicking in the lock icon.
6. Click each layer separately and adjust their sizing parameters as follows. Note: You need to unlock the aspect ratio for each layer.
Layer1
 - a) H Size: 1720
 - b) V size: 970
 - c) H Pos: 100
 - d) V Pos: 50Layer2
 - a) H Size: 1720
 - b) V size: 970
 - c) H Pos: 1920
 - d) V Pos: 50
7. Click the sources under KIPRO1 and Mac-Power Point and drop them into the perspective layers.
8. Select both layers on the Preview.
9. Transition the layers to program.
10. Drop the KIPRO2 source to the layer on the left.

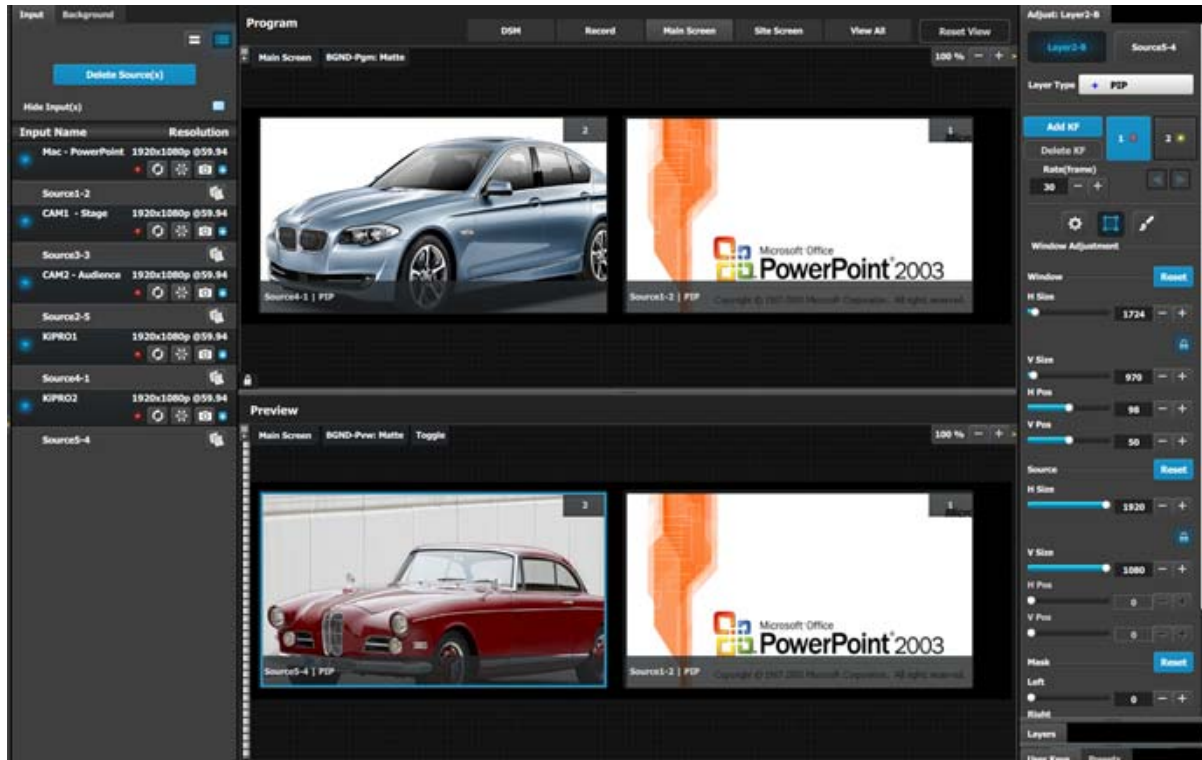

Image 9-22

P6: Drop Sources into Aux Screens (DMS Output)

1. On top click on the **DSM** tab.
2. Drag the CAM 1 input1 into the preview screen.

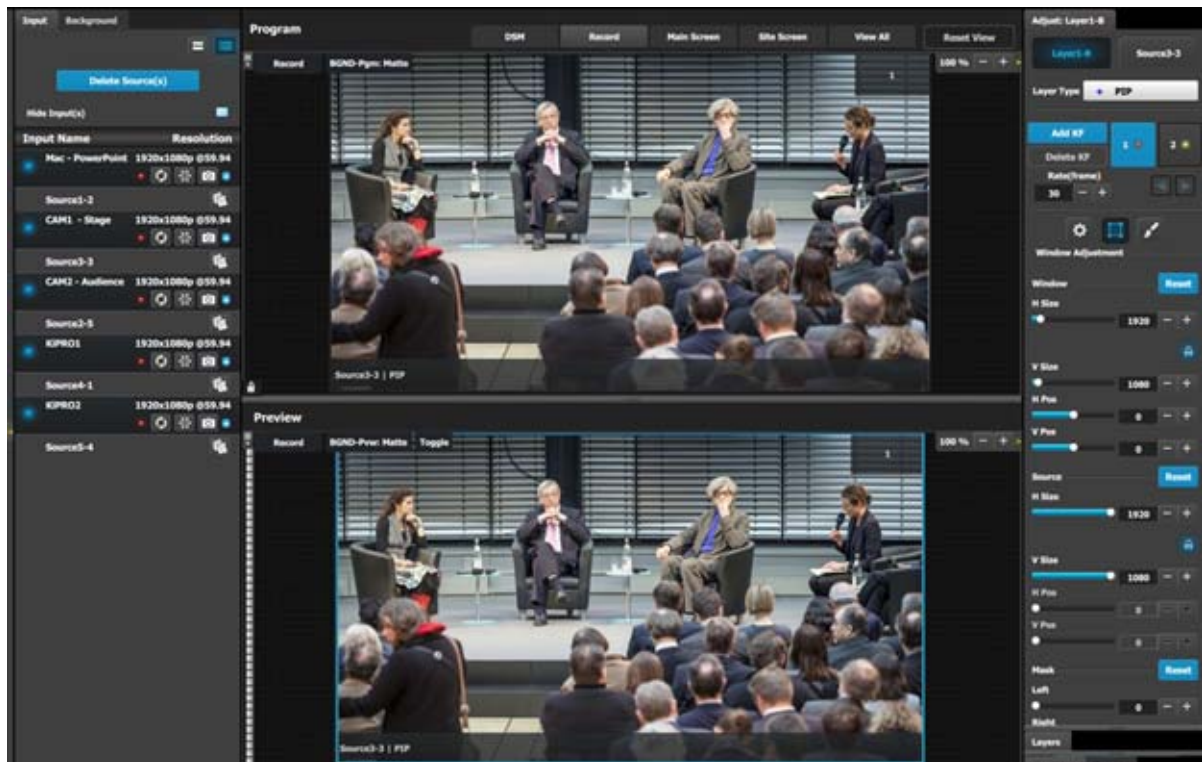

Image 9-23



P7: In this application we will not save any user keys. All layers attributes will be saved.

P7: Create user Keys and Presets

1. Select the Site screen destination and the layer in preview.
2. Under the Preset tab click in the "Save to new Preset" button.
3. Edit the name to reflect the source that is on Preview.
4. Repeat the previous steps to save 3 more presets, so we have a preset for both video clips and both cameras.

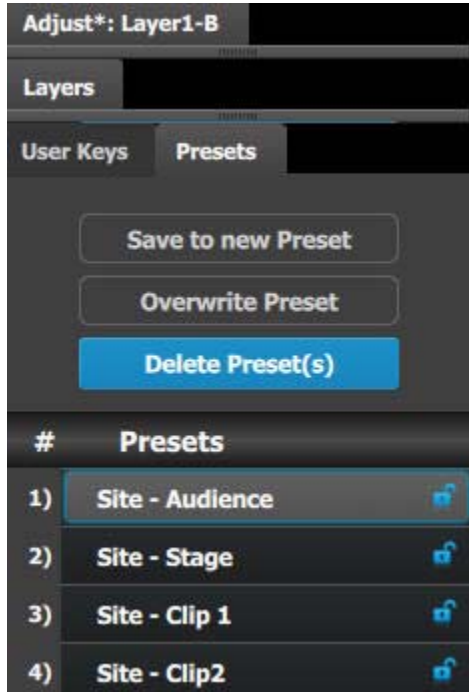

Image 9-24

5. Select the Main screen and select the sources into the two PIPs are the event requirements described in the introduction of the application note.
6. Save each look into a preset and give it an appropriate name.

Now you are ready to execute the presets and transition on the desire preview look into Program. Remember to select the corresponding destinations when you use the **Trans All** button.

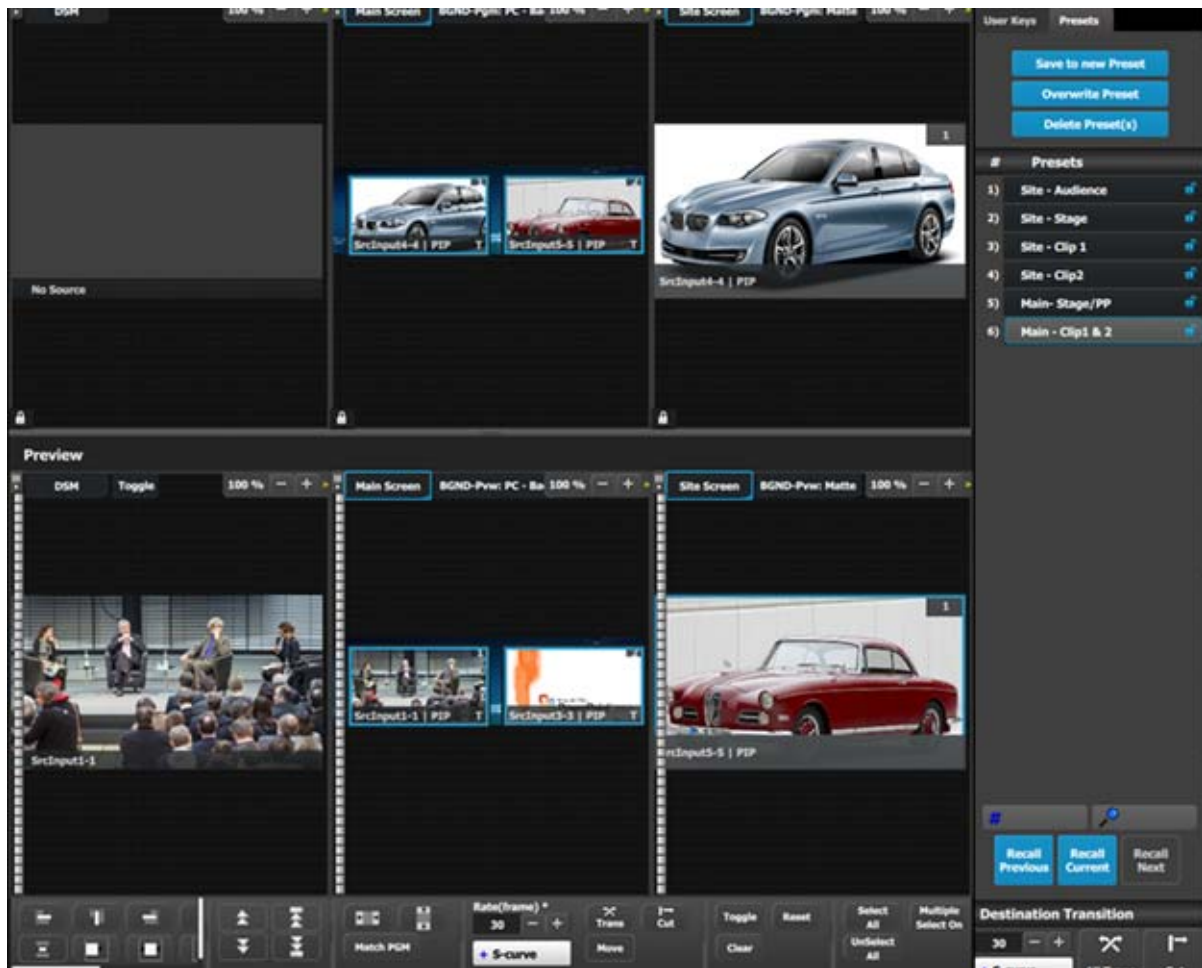

Image 9-25

9.6 Multiviewer (MVR) Menu



Make sure that you have assigned connectors to MVR outputs as outlined in section C7 before you proceed.

Overview

Click on the Multiviewer icon on the left hand side of the screen to reach the Multiviewer Menu, the module used to setup the Multiviewer outputs to the MRV monitors. You should see two screens since two Multiviewer outputs were declared.

We will setup the top window to display all the inputs and the bottom window to display the Program and preview screens.

Setup the “Sources” window

1. Click on the top tab that is labeled “MVROut1”.
2. Click on the **Auto Layout Input** button that is located at the bottom of the display area. All of the sources will appear lined up at the top of the window.
3. Click on the Background tab and the top of the right hand side.
4. Drag the PC-Background into the Window area.

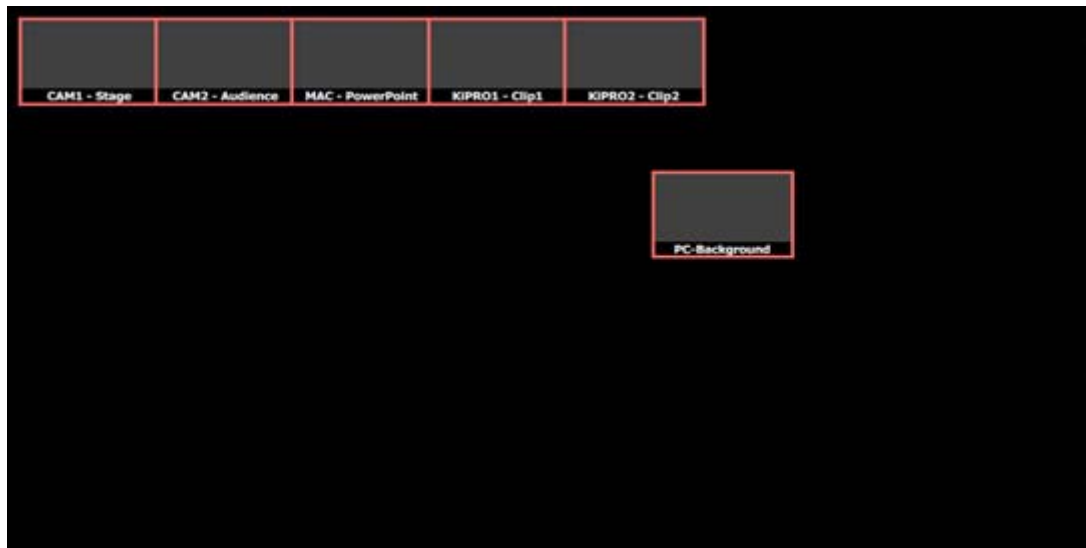

Image 9-26

5. Resize and arrange the PIPs to fill the screen.



Image 9-27

Setup the “Program/Preview” window

1. Click on the top tab that is labeled “MVROut2”.
2. Click on the **Destination** tab and the top of the right hand side.
3. Drag the Program and Previews under the Site and Main Screens into the window area.
4. Resize and arrange the PIPs so they appear as follows:

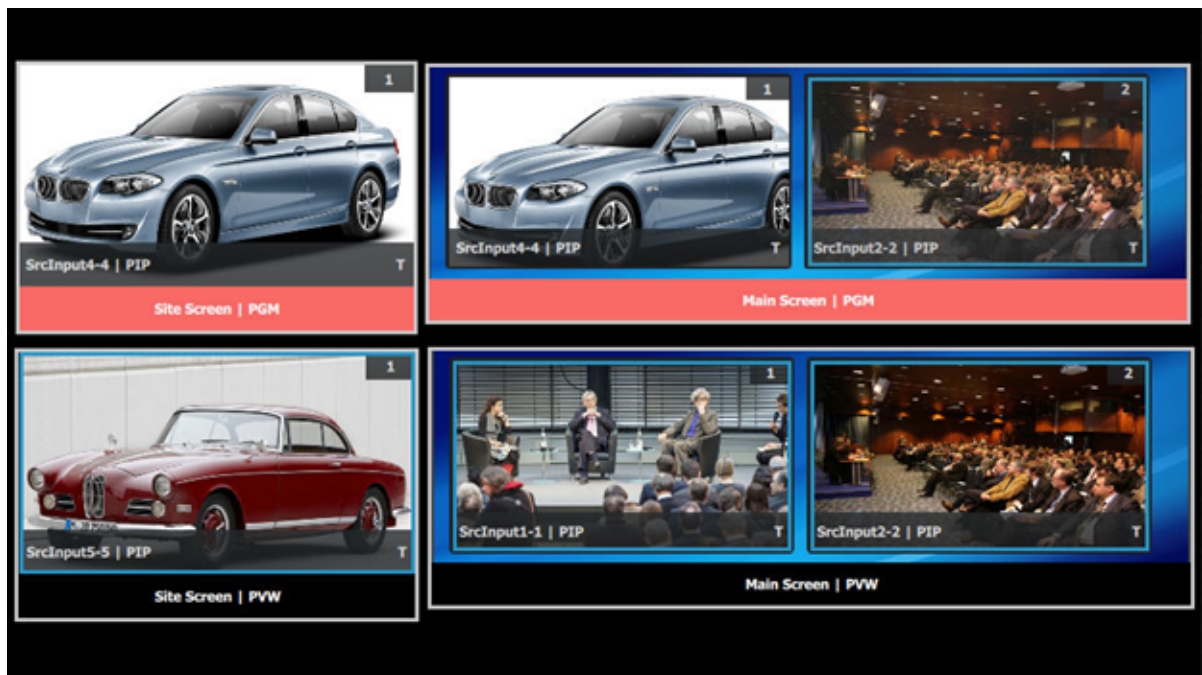

Image 9-28

10. CONTROLLER ORIENTATION

About this chapter

This chapter provides a detailed description of the Event Master controllers.

Overview

- General description
- EC-30 front panel overview
- EC-30 backside overview
- EC-50 front panel overview
- EC-50 backside overview
- EC-200 front panel overview
- EC-200 backside overview
- Use of color
- Touch screen
- Destinations buttons
- Layer buttons
- Assign buttons with contextual displays
- T-Bar
- Transition buttons
- Future Expansion Button Group (EC-200 only)
- Direct Selection Button Group and Barco Eye Button (EC-200 only)
- System Function Button Group (EC-200 only)
- Syntax Entry Button Group (EC-200 only)
- Contextual Display Button Group (EC-200 only)
- Num Pad Button Group (EC-200 only)
- Live Function Button Group (EC-200 only)
- Trackball (EC-200 only)
- Rotary Encoders (EC-200 only)
- Panel Lock button (EC-200 only)
- Save Button (EC-200 only)

10.1 General description

General

Event Master controllers are dedicated hardware consoles specifically designed to support the Event Master series processors, devices, and systems created from several of them. They run the Event Master Toolset Software (EMTS) and the EC-200 on an industrial operating system with optimized hardware. They include tactile operation style with buttons and touch screen displays, allowing for easy and direct control of the Event Master series processors..

There are three models of Event Master controller:

- EC-30 (compact controller).
- EC-50 (small controller).
- EC-200 (large controller).

The EC-30 is the most compact version of the EC-series Event Master controllers. As an extension of the EMTS, the EC-30 provides essential selections for sources, presets, layers, and destinations. The EC-30 connects as a USB peripheral to an existing Event Master control computer.

The EC-50 is a wing concept, or an accessory to the EC-200, and it needs either a host computer running the EMTS or an EC-200 controller for full function. The button layout of the EC-50 is identical to the layout found on the left-hand side of the EC-200, and the buttons have the same functions as the buttons on an EC-200.

The Event Master EC-200 controller is a dedicated hardware console specifically designed to support Event Master series processors and devices. It runs the EMTS. It can stand alone, or it can support additional external Event Master compatible devices over network and USB.

Main components overview

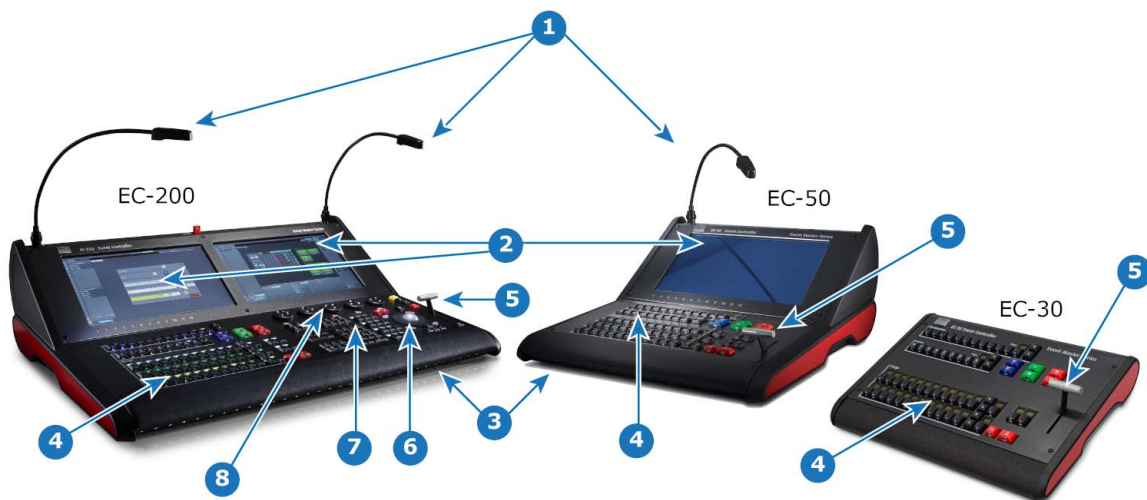

Image 10-1
Controller main components overview

	EC-200 large controller	EC-50 small controller	EC-30 compact controller
1	2x work lights (flexible support)	1x work light (flexible support)	NA
2	2x Touch screens	1x Touch screen	NA
3	Back light on front face	Back light on front face	NA
4	User assignable presentation buttons	User assignable presentation buttons	User assignable presentation buttons
5	T-bar	T-bar	T-bar
6	Trackball and ring	NA	NA
7	Function buttons and numpad	NA	NA
8	Wheel (rotary encoders) layout	NA	NA

EC-200 General description

The Event Master EC-200 controller is dedicated computing hardware. Its front has a keyboard area and two touchscreens, and the back has connectors. It runs its software, the Event Master Toolset, on an industrial Linux operating system.

Tactile operation with buttons and touch screen displays allow for easy and direct control of the Event Master series processors.

EC-50 General description

The small form factor of the EC-50 is equally at home next to an EC-200 or as part of a Event Master Toolset Win PC or MAC OSX System.

It provides a traditional T-Bar and button interface for the Destination, layer and preset functions of the EventMaster Toolset.

It uses the same high quality controls as found in the EC-200 console, ensuring responsive and reliable operation.

A 15.6 inch widescreen with 10 point multi touch is integrated in the wing allowing you to connect a screen output from your host system.

One LED desk light is supplied, fully dimmable and software controllable. The other light intensities are also adjustable via the EMTS Settings Menu page.

A 15.6 inch HD widescreen with 10 point multi touch is integrated in the wing allowing you to connect a screen output from your host system.

EC-30 General description

The compact EC-30 is a USB peripheral added to an Event Master control computer. It provides essential selections for sources, presets, layers, and destinations.

10.2 EC-30 front panel overview

Overview

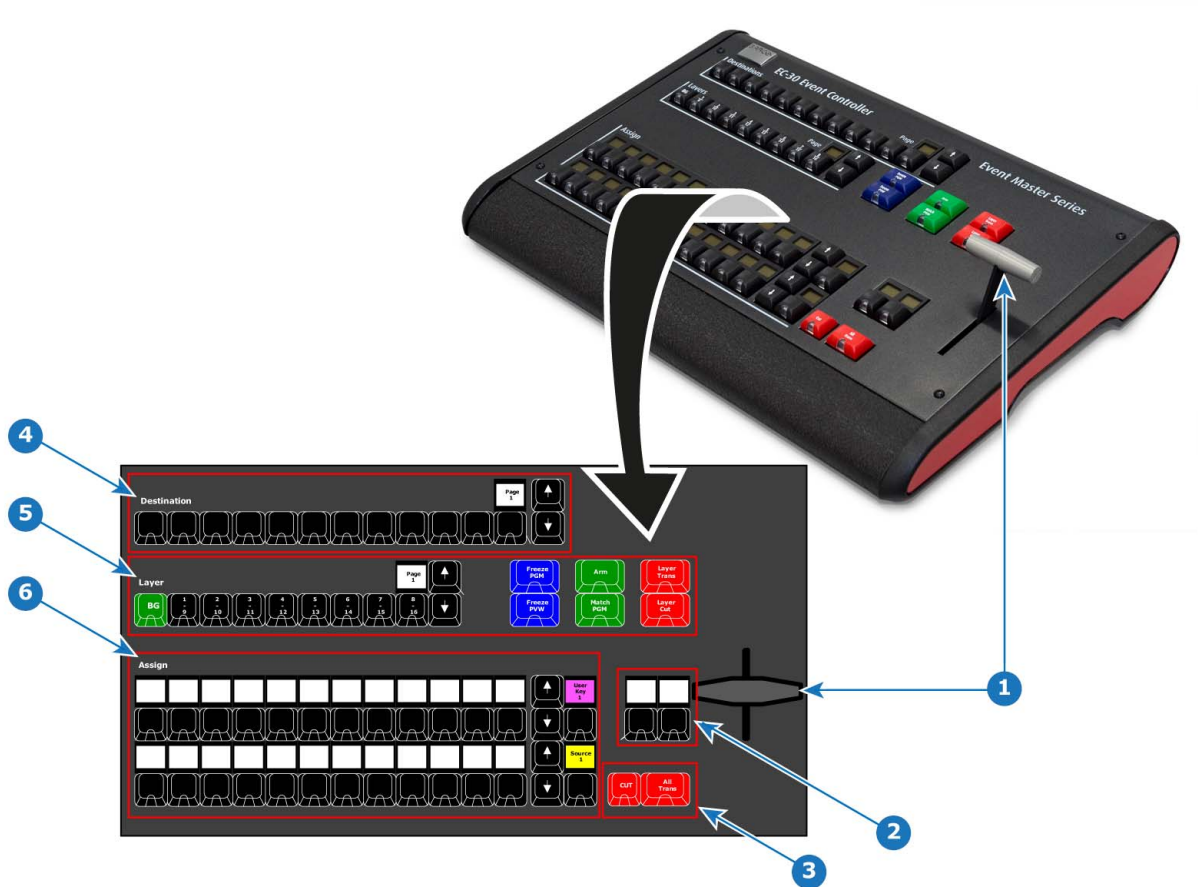

Image 10-2
EC-30 front panel overview

1	T-bar
2	User-assignable contextual display buttons
3	Cut and All Trans buttons
4	12 Destination buttons and a contextual display showing page of Destinations
5	Layer buttons and a contextual display showing page of Layers
6	Assign buttons in two identical rows that can host multiple selections and a contextual display showing page of the Assign button row

10.3 EC-30 backside overview

Overview

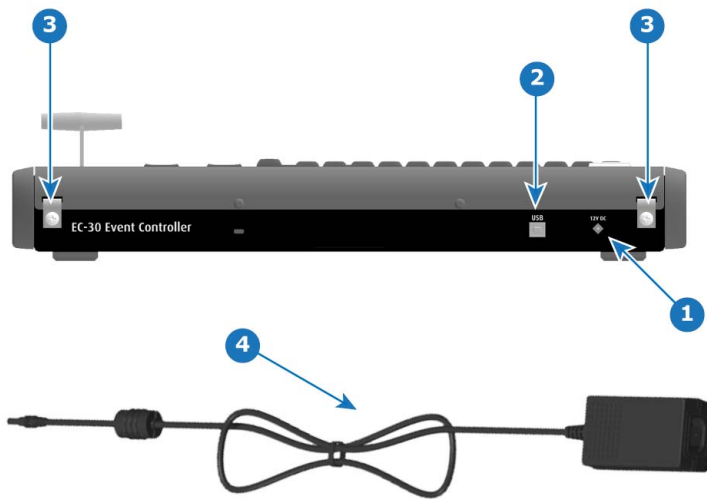

Image 10-3
EC-30 backside overview

1	DC power
2	USB B to Host
3	Strain-relief tabs
4	25W, 12V power supply

10.4 EC-50 front panel overview

Overview

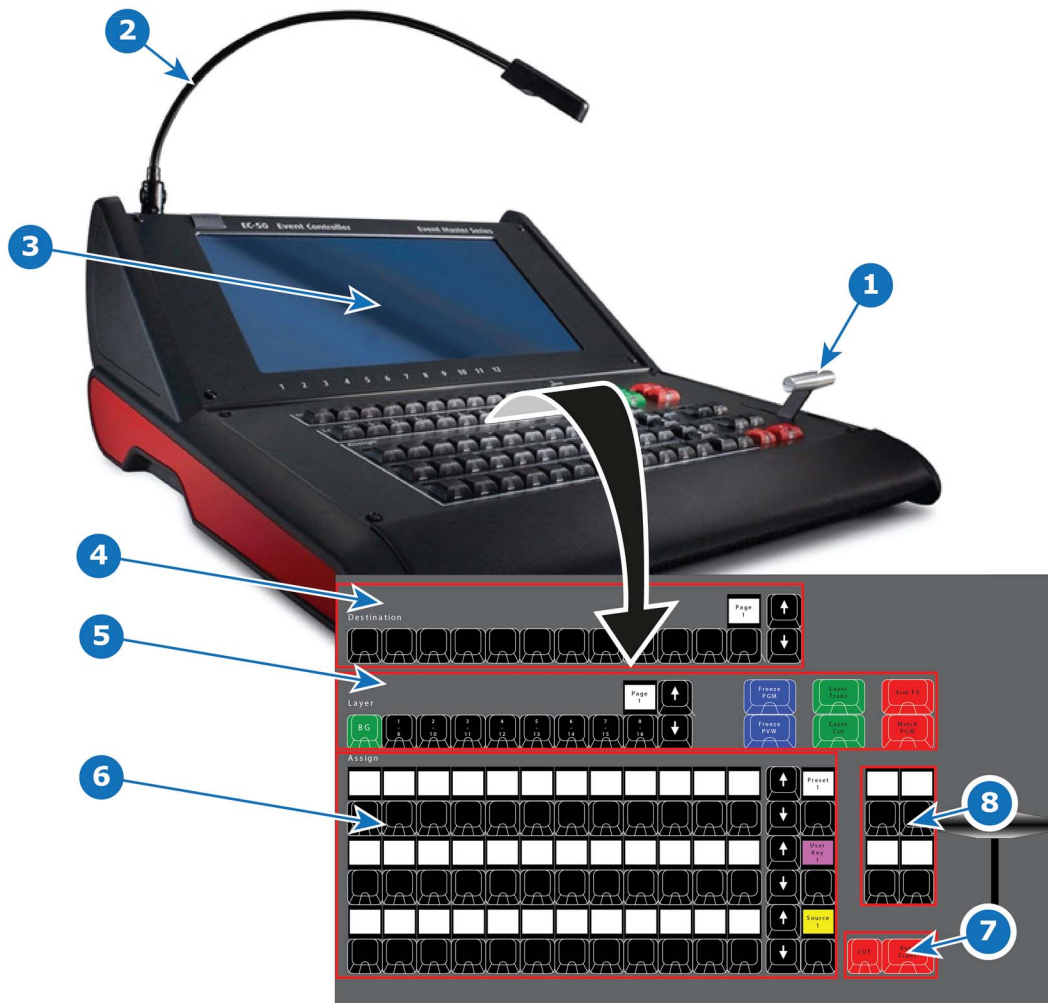

Image 10-4
EC-50 front panel overview

1	T-bar
2	Work light (flexible support)
3	Touch screen
4	12 Destination buttons and a contextual display showing page of Destinations
5	Layer buttons and a contextual display showing page of Layers
6	Assign Buttons in three identical rows that can host multiple selections and a contextual display showing page of the Assign button row
7	Cut and All Trans buttons
8	User-assignable contextual display buttons

10.5 EC-50 backside overview

Overview

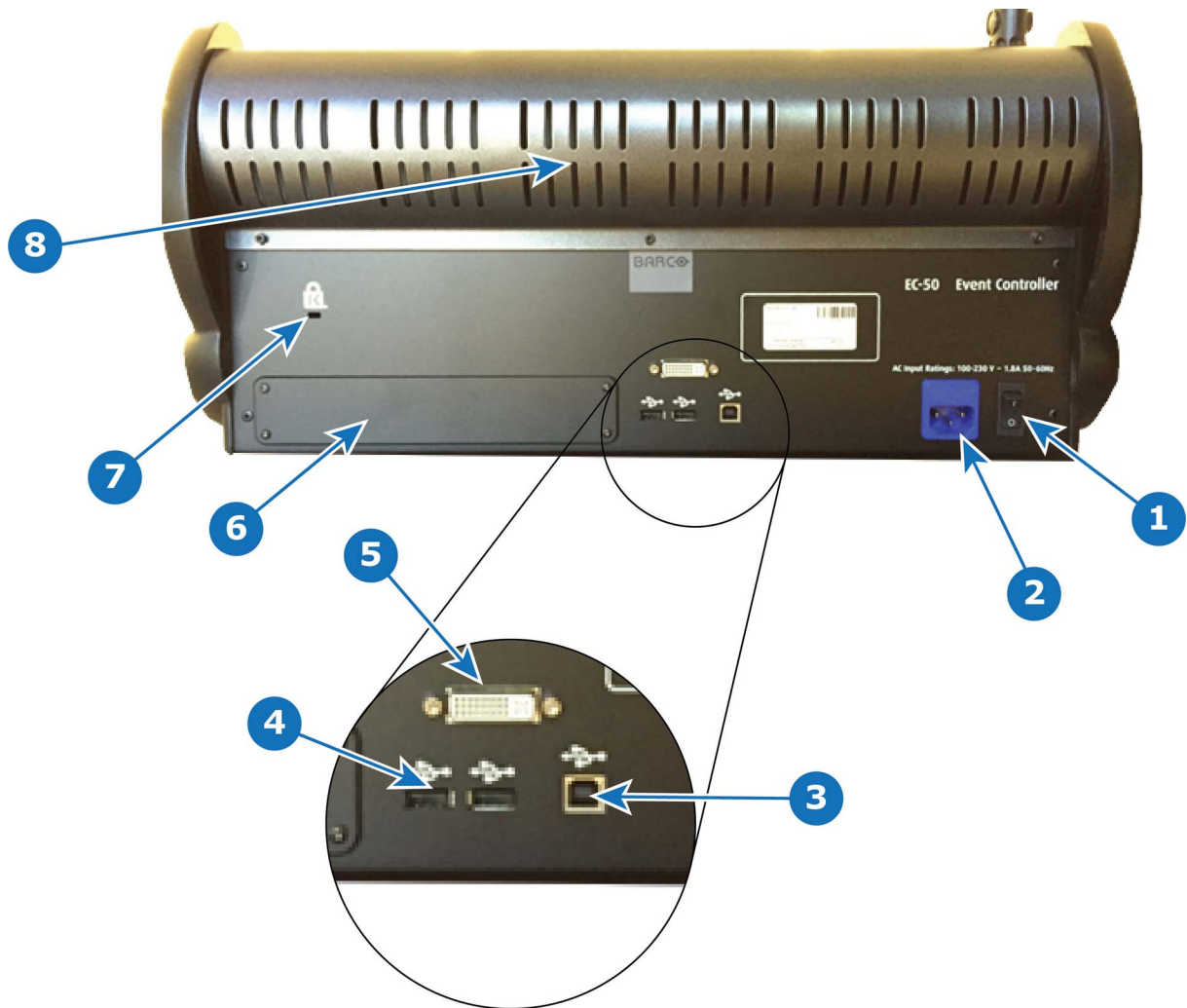

Image 10-5

1	Power switch
2	Power connector
3	USB B connector for connection to Host system
4	2x USB A Connectors for USB peripherals, such as mouse and keyboard
5	DVI Input connector for a standard DVI or VGA video signal
6	Optional accessory location for future expansions
7	Kensington Lock attachment point
8	Red effects light (located behind rear vent holes)

10.6 EC-200 front panel overview

Overview

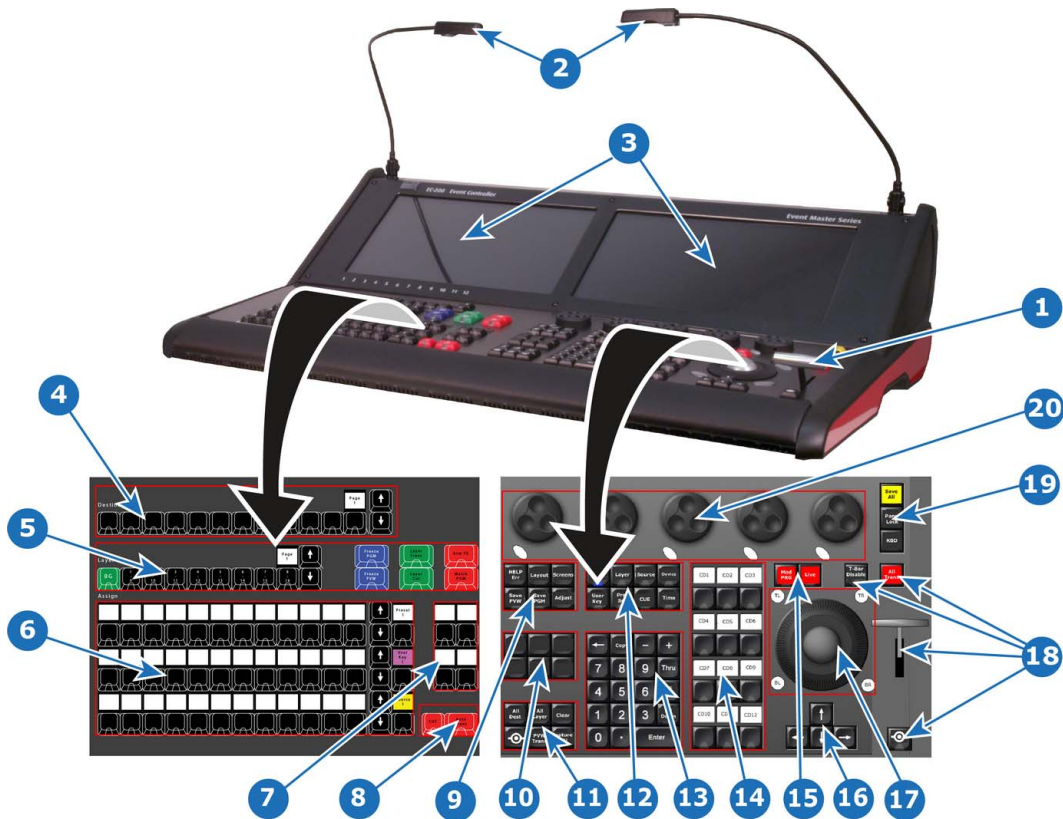

Image 10-6

1	T-bar	11	Direct selection button group
2	Work light (flexible support)	12	Syntax entry button group
3	Touch screen	13	Numpad
4	12 Destination buttons and a contextual display showing page of Destinations	14	Contextual display button group
5	Layer buttons and a contextual display showing page of Layers	15	Live function button group
6	Assign buttons in three identical rows that can host multiple selections and a contextual display showing page of the Assign button row	16	Arrow button group
7	User-assignable contextual display buttons	17	Trackball with 4 modifier buttons
8	Cut and All Trans buttons	18	T-bar with Disable button, All Trans, and Barco Eye function button
9	System function button group	19	On-screen keyboard button, console lock button, Save All button
10	Future expansion button group	20	Rotary encoders, referred to as wheels, with modifier buttons

10.7 EC-200 backside overview

Overview

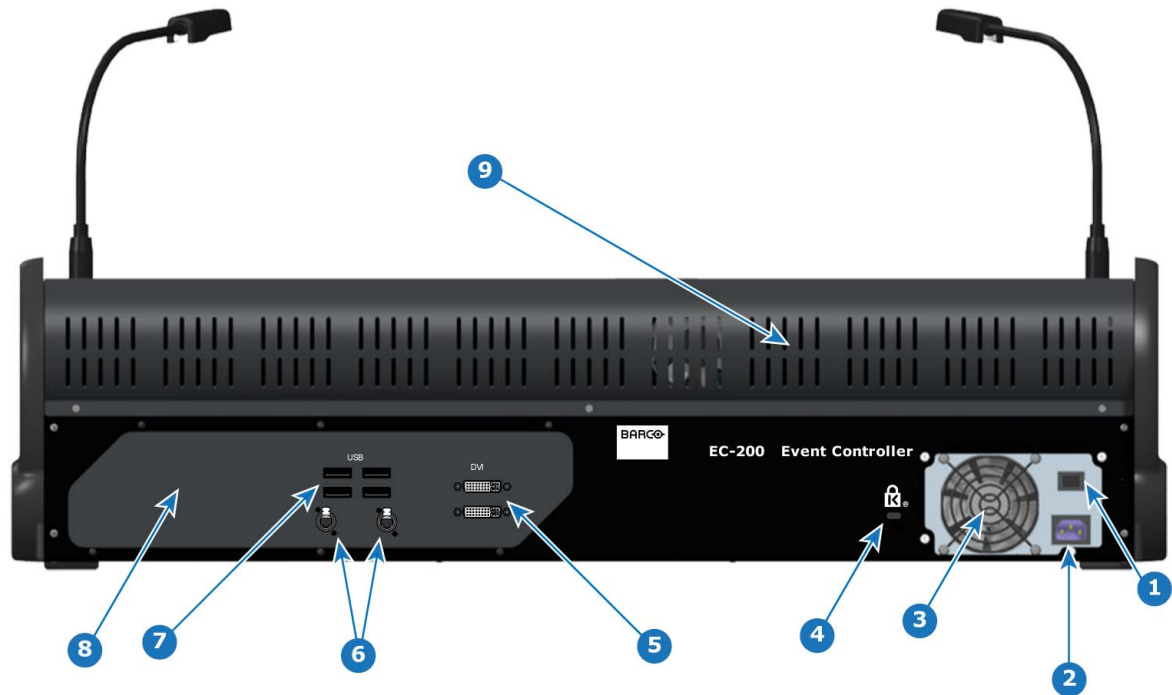

Image 10-7
EC-200 backside overview

1	Power switch
2	Power connector
3	PSU fan outlet, not to be blocked.
4	2x DVI Output connector for a standard HD DVI signal
5	4x USB A connectors for USB peripherals, such as mouse and keyboard
6	2x Ethernet RJ45 network connectors
7	Optional accessory location for future expansions
8	Kensington Lock attachment point
9	Red effects light (located behind rear vent holes)

10.8 Use of color

General

The unit has several colored buttons and led indications which support the user by indicating selections and possible actions.

Button color

- Blue buttons indicate the Freeze function.
- Green buttons indicate a layer selection or an action to a layer selection.
- Red buttons always indicate Transitions.
- Yellow indicate save functionality.
- Black is neutral.

Led Color in buttons

- Blue indicates selected in destination buttons.
- Green indicates that the layer on preview is selected (Normal).
- Green can also indicate that the buttons function has an opposite function or other mode.
- Red indicates that the layer on program is selected (Live or Unlocked Program).
- Red can also indicate that the buttons function is selected / active, like T-Bar Disable.

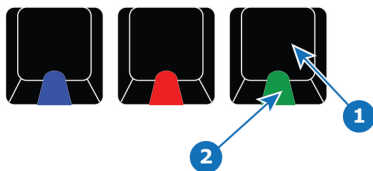

Image 10-8
1 Button
2 LED

Backlight color for display



Applies to an entire row of displays.

- Source = Yellow backlight.
- User Key = Magenta backlight.
- Background Source = Green backlight.
- Preset = White backlight.



A Red backlight is reserved for LOS (Loss Of Signal).

10.9 Touch screen

General

The touchscreen is a 10 point multi touch HD (1920x1080) screen. It offers direct interaction with the Toolsets UI. Most notably the console setup page that works both as the assign page and a “virtual controller” allowing for button interaction.

10.10 Destinations buttons

Overview

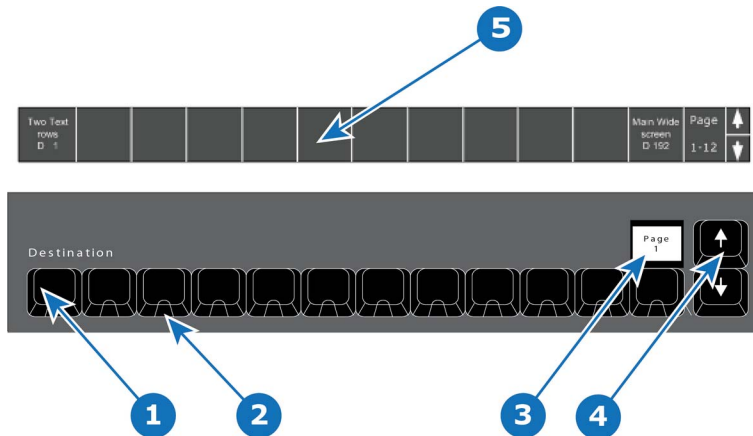

Image 10-9

- 1 12 destinations buttons.
- 2 Blue LED.
- 3 Contextual Display (show the range of buttons — e.g. 1–12).
- 4 Arrow buttons (up and down).
- 5 Names of destinations written in the bottom of the screen.

Description

The 12 destinations buttons have several pages which allows an operator to define custom orders and layouts of mapped Destinations.

The name of the destination is written in the bottom of the console menu page. It can be shown or hidden on preference.

The Contextual Display above button 12 will show the range of buttons 1 – 12, 13 – 24 etc. Use the **Arrow** (up and down) to change the range.

LED color under the Destinations buttons are BLUE. This indicates the Destination is selected when lit.

10.11 Layer buttons

Overview

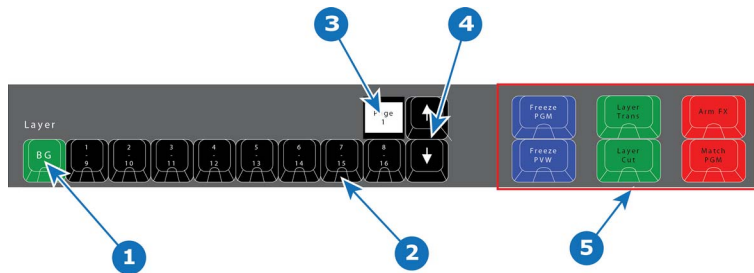

Image 10-10

- 1 Background button + 8 Layer buttons.
- 2 LED (Red or Green).
- 3 Contextual Display (show the range of buttons — e.g. 1–8).
- 4 Arrow buttons (up and down).
- 5 Layer Operator buttons.

Description

There are 9 Layer buttons with as many pages as supported by the system. The red or green LEDs under these buttons indicate the selection of layers. The first button is ALWAYS background layer and therefore marked BG.

LED color under Layer buttons are RED and GREEN:

LED color	Description
Red	Selected on PGM
Green	Selected on PVW

Button 2 – 9 is marked 1/8 on top and 9/16 on the bottom of the button.

The contextual Display above the button marked 8/16 will show the range of buttons 1 – 8, 9 – 16 etc. Use the **Arrow** (up and down) to change the range.

Layer Operator Buttons

The six larger buttons to the left of the Layer buttons are Layer Executor buttons mapped to the corresponding functions in the EMTS. These are further explained below in chapter "Controller Operation", page 347.

10.12 Assign buttons with contextual displays

Overview

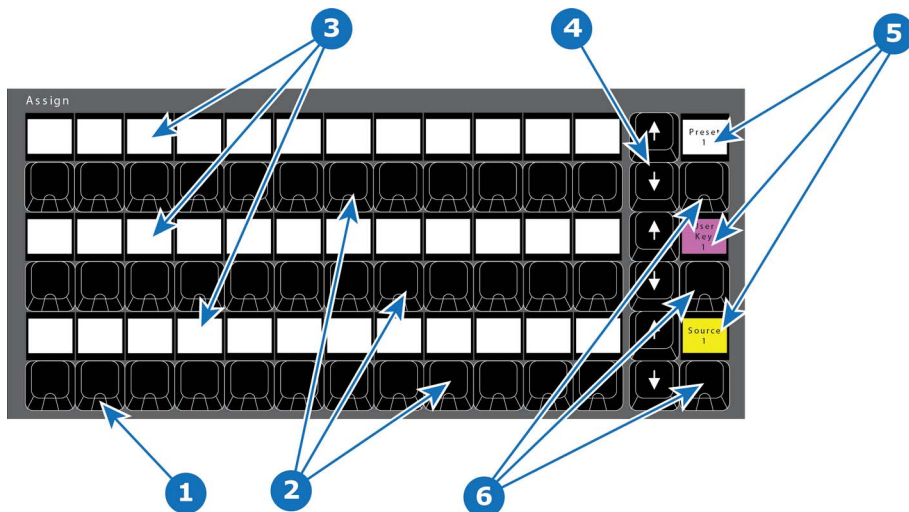

Image 10-11

- 1 LED (Red or Green).
- 2 Three rows of 12 Assign buttons
- 3 Three rows of 12 displays
- 4 Three rows of 2 Arrow buttons (up and down).
- 5 Three displays
- 6 Three type buttons

Description

The three rows of 12 buttons, each with a dedicated display can be assigned with several types of functions including memories, Source Files, Presets and UseKeys.

Each row also has an Up and Down arrow buttons which are used to switch between pages per row.

An additional button to the right of the arrow buttons on that row is called BUTTON TYPE. It has a display above it. The button toggles between assign types with multicolor indication of selected assign button type.

LEDs under the Assign buttons are RED and GREEN:

LED color	Description
Red	for On PGM
Green	for On PVW

Backlight color assign per function (for an entire row) :

Function	Color
Source	Yellow backlight
User Key	Magenta backlight
Background Source	Green backlight
Preset	White backlight
Cue	Cyan backlight
Command List	Blue backlight

10.13 T-Bar

EC-50 Overview

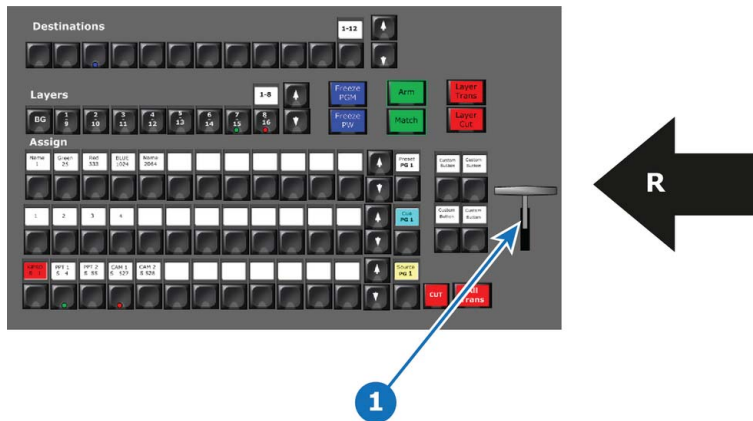

Image 10-12
 1 T-Bar
 R Right Side of the Controller

EC-200 Overview



Image 10-13
 1 T-Bar
 2 T-Bar disable button
 R Right Side of the Controller

Description

A traditional manual transition T-bar is included in the consoles. It's placed to the rightmost of the console for convenience.

The EC-200 has a T-Bar disable button above to the left. The button has a red led indication who stays lit when the T-Bar is disabled.

The T-Bar will transition from 0 to 100% of the transition for Destinations and will cut Auxiliary at 50%.

In the event of a unknown state a up or down motion of the T-Bar will re-align the T-Bar to 0%. If the unknown state was between 0 and 100% the T-Bar will continue and push the transition thru to 100%.

10.14 Transition buttons

EC-50 Overview

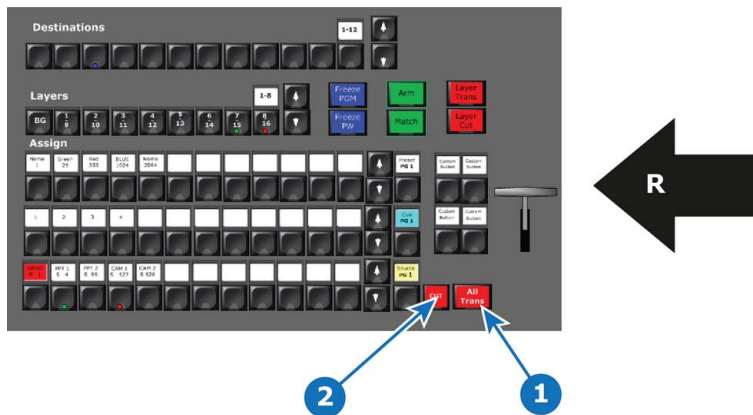

Image 10-14
 1 All Trans
 2 Cut
 R Right Side of the Controller

EC-200 Overview

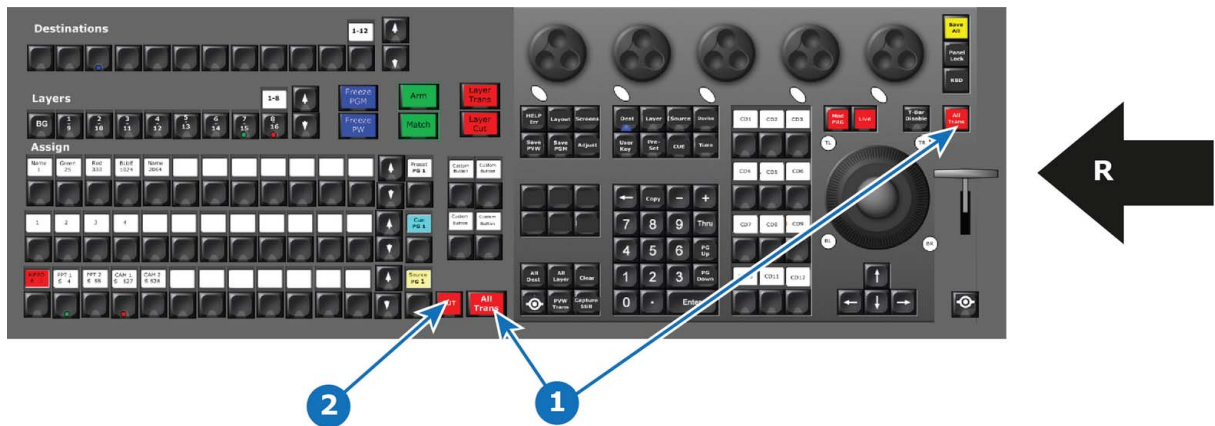

Image 10-15
 1 All Trans
 2 Cut
 R Right Side of the Controller

Description

Depending the controller type, two or three buttons are provided for transitional triggering:

Type of transition	EC-50	EC-200
All Trans	1 button	2 buttons
Cut	1 button	1 button

All Trans

Preview transitions to Program according at the rate indicated in the rate box following the s-curve pattern. The layer on Program does NOT fade in preview at the same time. The layer on Program appears in Preview when the transition is completed.

Cut

Instantly transitions the Preview to Program.

10.15 Future Expansion Button Group (EC-200 only)

Overview

This group of buttons is present only on the large controller.

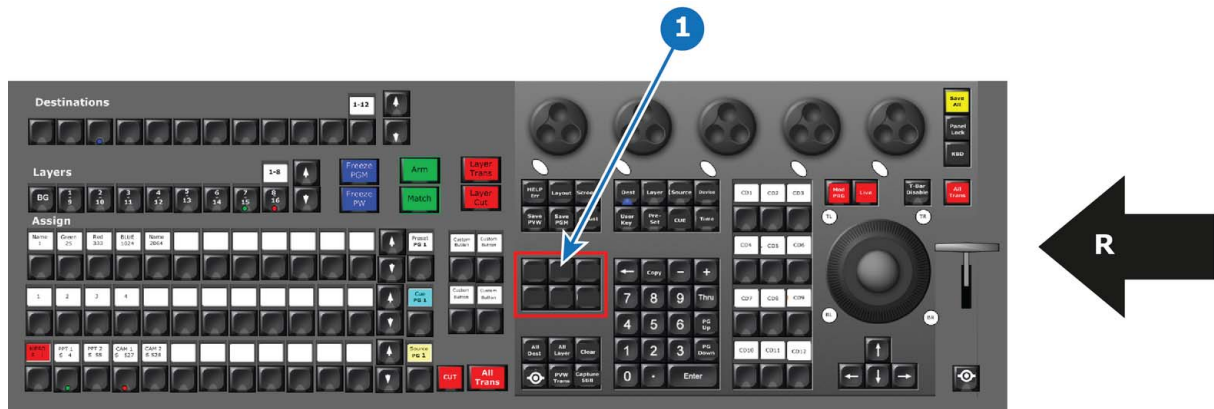

Image 10-16
 1 Future Expansion Button Group
 R Right Side of the Controller

Description

This group of buttons hold a promise for future functions.

10.16 Direct Selection Button Group and Barco Eye Button (EC-200 only)

Overview

These buttons are present only on the large controller.

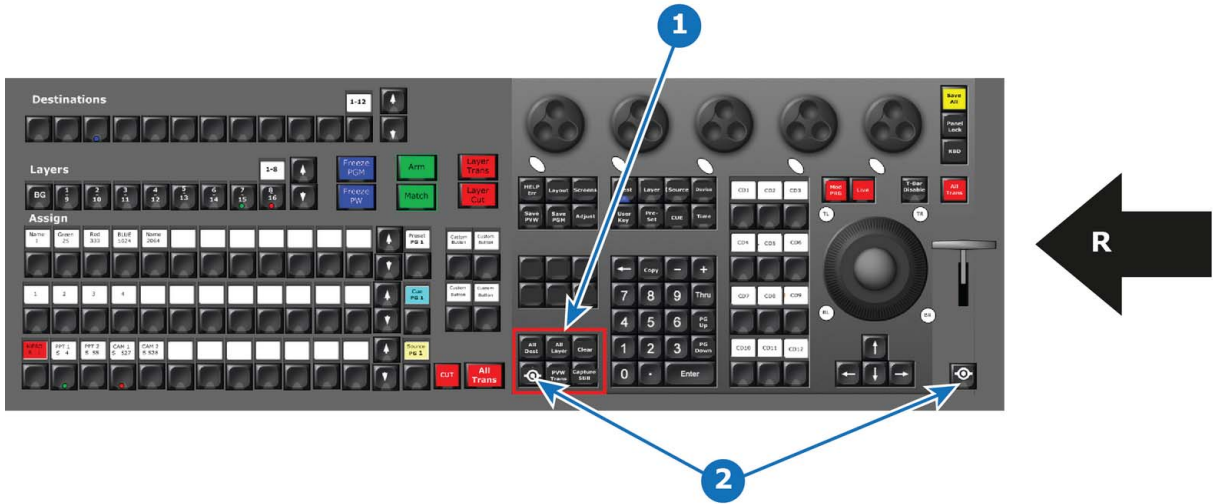

Image 10-17
 1 Selection Button Group
 2 Barco Eye button (2x)
 R Right Side of the Controller

Description

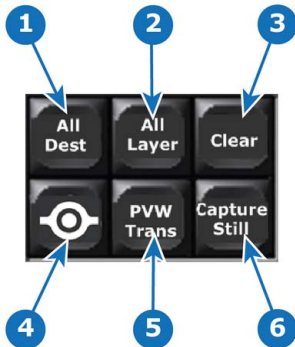

Image 10-18

	Button Name	Description
1	All Dest	Selects all Destinations for further actions or with Press and Hold have extended function.
2	All Layer	Selects all Layers in selected Destination(s) for further actions or with Press and Hold have extended function.
3	Clear	The CLEAR button has the same function as the Clear GUI Button. Extended functionality is reached with Press and Hold for various Buttons.
4	Barco Eye	Modifier Button, like Windows/CTRL/Fn button on a keyboard. Further described in functionality around other buttons. Note: A second Barco Eye Button, who has the same function as its twin, is situated to the right on the console.
5	PVW Trans	The PVW Trans button has the same function as the PVW Trans GUI Button.
6	Capture Still	The Capture Still Button is used in Syntax entry to record and restore Still Stores from the Inputs.

10.17 System Function Button Group (EC-200 only)

Overview

This group of buttons is present only on the large controller.

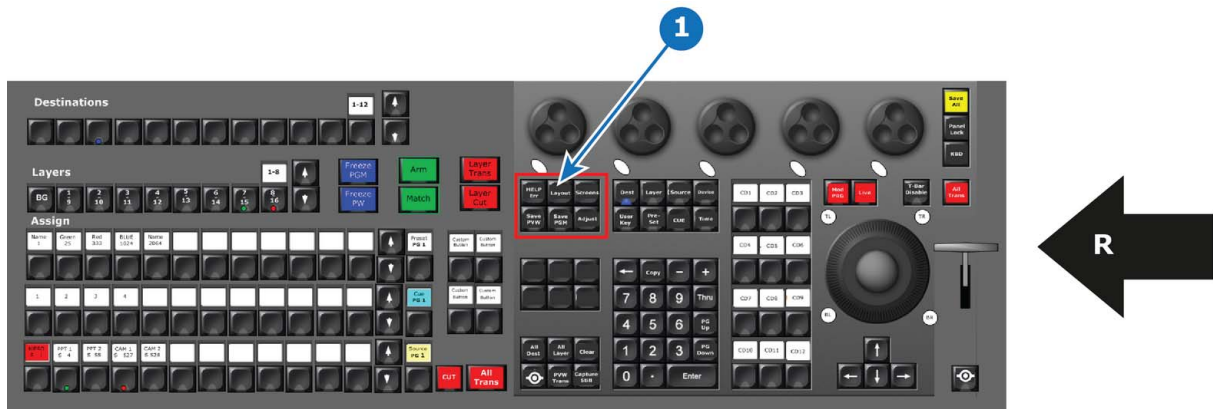

Image 10-19
 1 System function Button Group
 R Right Side of the Controller

Description

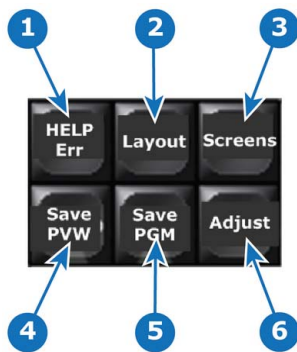

Image 10-20

	Button Name	Description
1	HELP Err	This button has currently no function.
2	Layout	The Layout Function Button allows for recording and recalling layouts where applicable like Multi-viewer, Assign Buttons and Programmer screen & Preset screen. In the future other features will benefit from this function.
3	Screens	This is the function to select the windows of the GUI currently in the displays of the controller. 2 internal and 2 external are possible.
4	Save PVW (Save Preview)	Latches and lights a RED led and activates a Store/Record Mode with applicable functions from Preview. The Save PVW of the GUI will be RED as long this mode is active.
5	Save PGM (Save Program)	Latches and activates a Store/Record Mode with applicable functions from Preview. The Save PGM of the GUI will be RED as long this mode is active.
6	Adjust	Pressing the Adjust Button opens the Adjust tab.

10.18 Syntax Entry Button Group (EC-200 only)

Overview

This group of buttons is present only on the large controller.



Image 10-21
 1 Syntax entry Button Group
 R Right Side of the Controller

Description



Image 10-22

These buttons are used in the programming syntax introduced with EC-200. A programming syntax will be necessary in order to effectively program the Event Master System once its full size becomes available.

When each group of resources can be several hundred, direct select buttons cease to be effective. The syntax allow direct access with a few keystrokes.

Each button is further explained in the chapter "Controller Operation", page 347,

10.19 Contextual Display Button Group (EC-200 only)

Overview

This group of buttons is present only on the large controller.

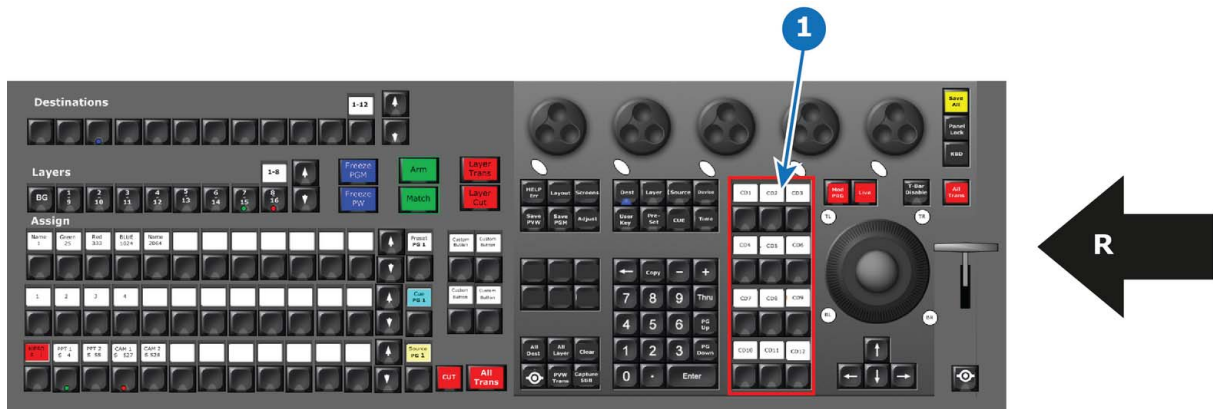

Image 10-23
 1 Contextual Display Button Group
 R Right Side of the Controller

Description

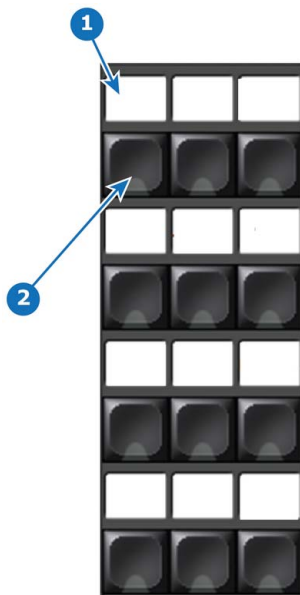

Image 10-24
 1 Display
 2 Button

These 12 Displays with its adjoining button allow different function based on the current programming need or “contextually mapped functions” and are called Contextual Display Buttons.

The Mapping of these are closely described in "Controller Operation", page 347

10.20 Num Pad Button Group (EC-200 only)

Overview

This group of buttons is present only on the large controller.



Image 10-25
1 Num Pad Button Group
R Right Side of the Controller

Description



Image 10-26

The almost standard layout Numpad buttons resemble a standard numpad from a keyboard or other device.

With its specifically added, Copy, Thru, Page Up and Page Down It is central for the Syntax Entry Programming introduced in EC-200.

The Numpad is used in conjunction with its own buttons or other buttons on the EC-200. Its use is covered in "Controller Operation", page 347.

10.21 Live Function Button Group (EC-200 only)

Overview

This group of buttons is present only on the large controller.

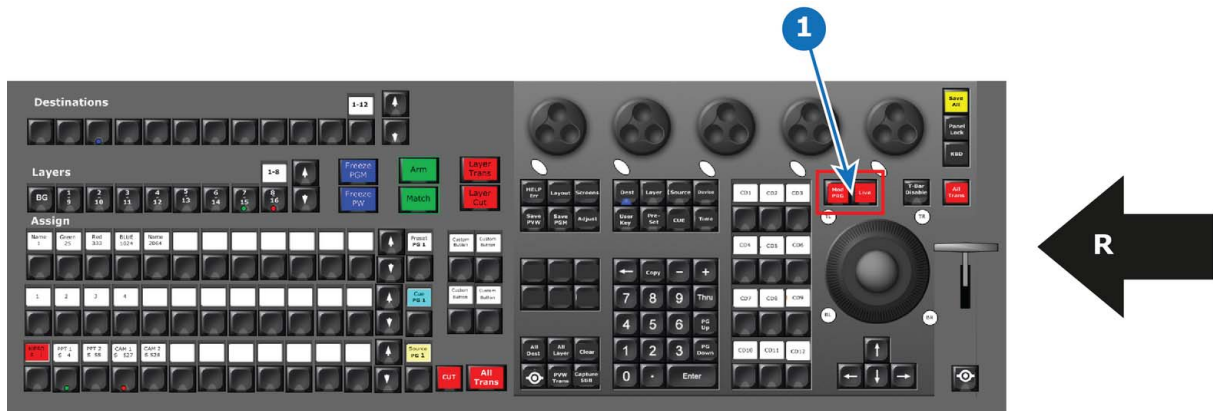

Image 10-27
 1 Live Function Button Group
 R Right Side of the Controller

Description

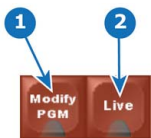

Image 10-28

	Button Name	Description
1	Modify PGM (Modify Program)	The Red Button Modify PGM toggles on and off the possibility to modify a destination in the Program Part of the GUI. The LED is steady lit with red when active.
2	Live	The Red Button Live toggles on and off the Live function like it was in Encore TM. The LED is steady lit with red when active.

The functionality of each of these buttons is more closely described in "Controller Operation", page 347.

10.22 Trackball (EC-200 only)

Overview

This assembly is present only on the large controller.

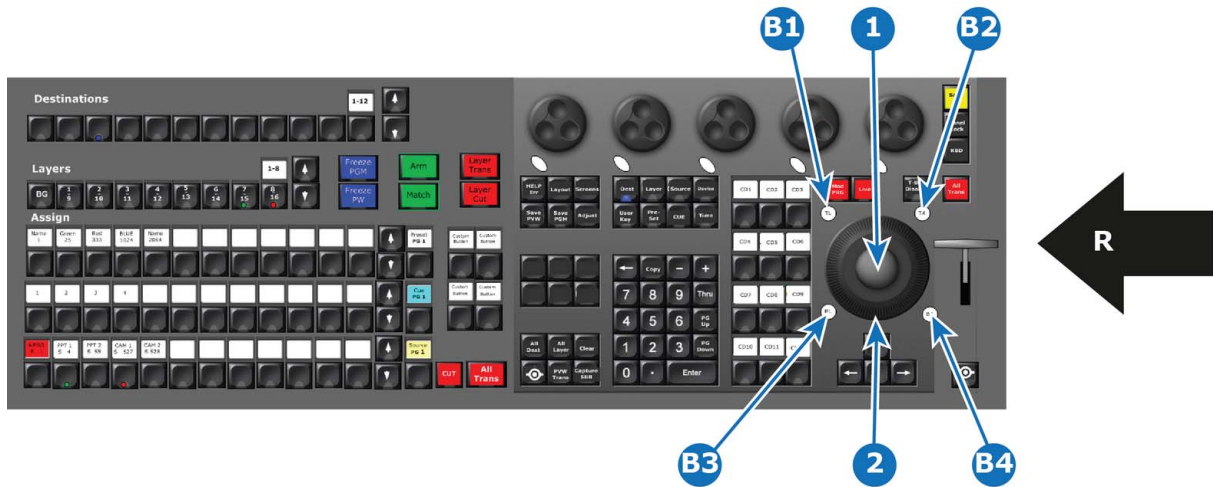

Image 10-29

- 1 Trackball
- 2 Ring
- B1 TL (Top Left) Button
- B2 TR (Top Right) Button
- B3 BL (Bottom Left) Button
- B4 BR (Bottom Right) Button

Description

This is a ergonomic control device used with thumb, finger or palm of your hand to move the cursor like with a mouse. Interaction with other parts of the interface is also possible.

Additional functionality of the Trackball and its modifiers is described in Chapter "Controller Operation", page 347.

10.23 Rotary Encoders (EC-200 only)

Overview

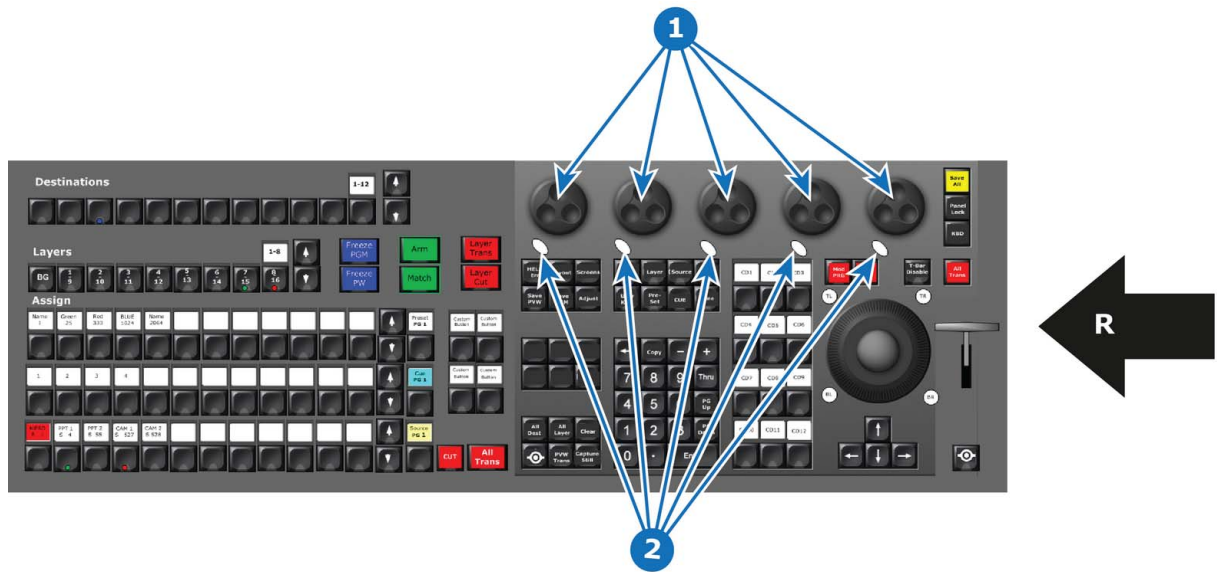

Image 10-30
 1 Rotary encoders
 2 Modifier buttons
 R Right Side of the Controller

Description

The 5 rotary encoders to the top left are referred to as wheels or modifier wheels. Wheels are named from left to right WH1 – WH5. They have one modifier button each.

These encoders are present only on the large controller.

10.24 Panel Lock button (EC-200 only)

Overview

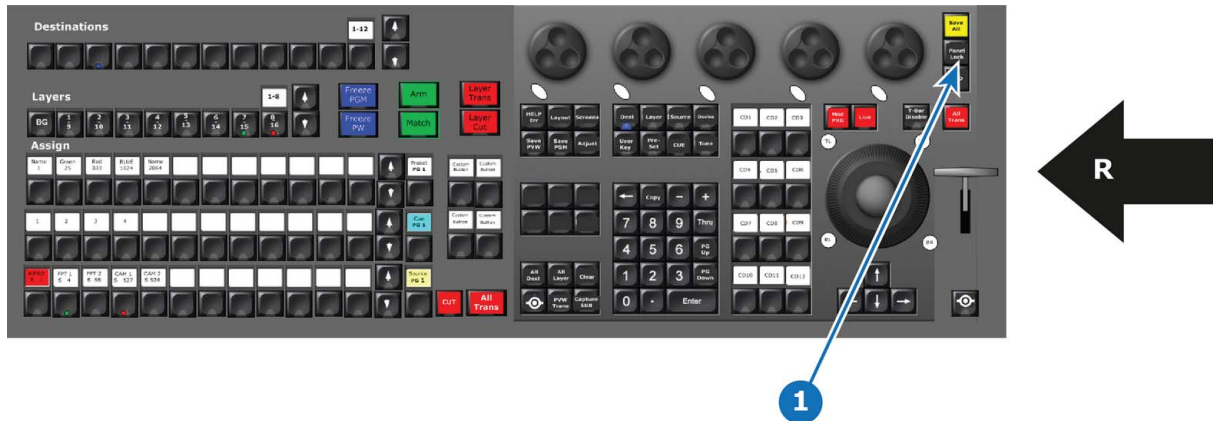

Image 10-31

- 1 Lock Panel Button
- R Right Side of the Controller

Description

Pressing the Panel Lock button will Lock the consoles buttons and touchscreens from entry. To unlock use code 4096 via numpad or Keyboard.

This button is present only on the large controller.

10.25 Save Button (EC-200 only)

Overview

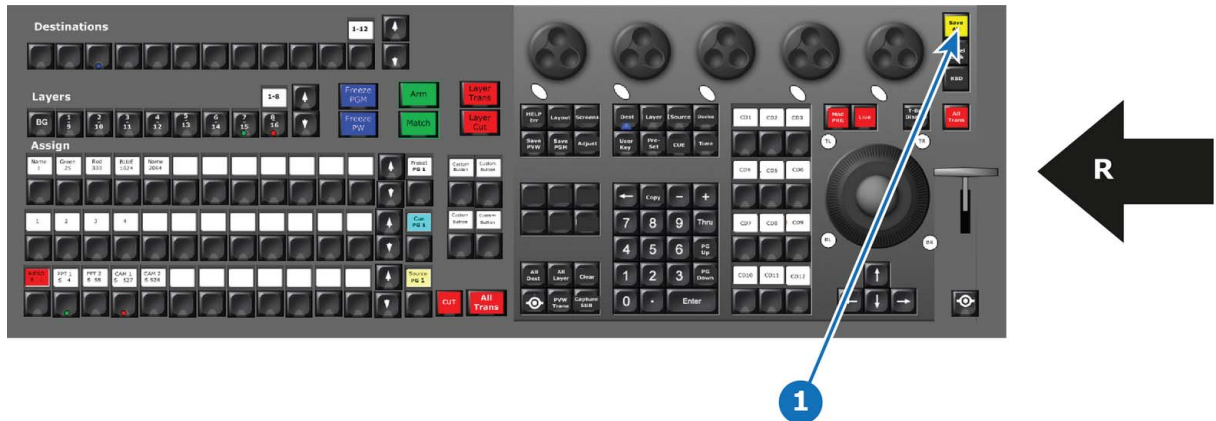

Image 10-32
 1 Save Button
 R Right Side of the Controller

Description

This button replicates the Save icon click in EMTS (Event Master Tool Set).

This button is present only on the large controller.

11. CONTROLLER CONFIGURATION

About this chapter

This chapter provides a detailed description of how to connect and configure the EC-30, EC-50, and EC-200 controllers.

Overview

- General
- EC-30 controller connection
- EC-50 controller connection
- EC-200 controller connection
- Touch screen calibration
- Lights
- Assigning resources to the desk

11.1 General

Overview

The EC-200 is a stand-alone controller that supplies full control over Events Master series devices. In the future, once the software in charge of this functionality is completely developed, the EC-200 will allow connection to up to two EC-50 wings.

The EC-50 is a wing-concept in the sense that it needs a host computer to work. Host computers specs should follow the outline for the Event Master Toolset "Preferred" spec.

The EC-30 is a compact version of the EC-series Event Master controller that is added to an existing Event Master control computer as a USB peripheral. The EC-30 provides essential selections for sources, presets, layers, and destinations.

11.2 EC-30 controller connection

Prerequisites

Event Master Toolset revision 4.2 or higher must be installed on the Host computer prior to the connection of the EC-30.



Verify that the Host computer is equipped with the latest software version available on the Barco web site (URL:<https://www.barco.com/>). Refer to the chapters "Download of Event Master Toolset Software", page 100 and "Software installation", page 101 for more information on the software downloading and how install it on the Host computer.

Connection diagram

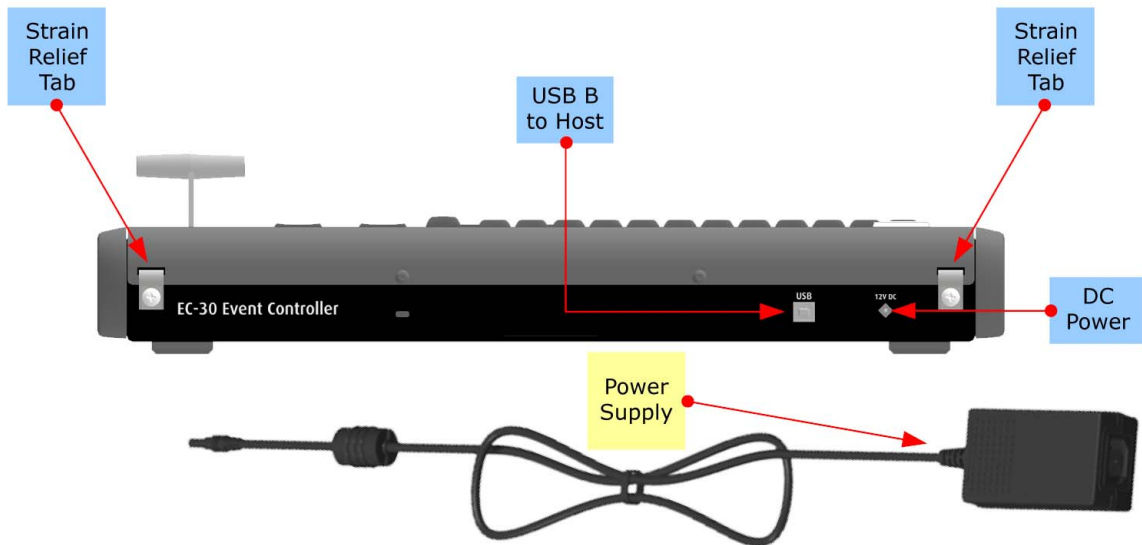

Image 11-1
EC-30 connections

Description

1. Connect the Host computer to the USB B connector on the EC-30. Necessary cables are provided in a new system. In the case that the original cables are missing, simply use standard computer cabling to make these connections.
2. Connect AC power to the power supply, and connect the power supply to DC power on the rear panel of the unit. Running the power-supply cable through one of the strain-relief tabs on the rear of the unit can help to keep the cable from pulling out of the DC power connector. Loosen the screw on a relief tab; run the power-supply cable through the tab; tighten the screw. You can consume extra cable length, if necessary, by passing the cable through both tabs.
3. Power up the EC-30 control panel, Host computer, and peripherals.



During the Event Master Toolset installation you are asked to add a driver, be sure to answer yes to this question in order to use the EC-30 with your host computer. If the driver is not installed the EC-30 will not work.

11.3 EC-50 controller connection

Prerequisites

Event Master Toolset revision 2.0 or higher must be installed on the Host computer prior to the connection of the EC-50.



Verify that the Host computer is equipped with the latest software version available on the Barco web site (URL: <https://www.barco.com/>). Refer to the chapters "Download of Event Master Toolset Software", page 100 and "Software installation", page 101 for more information on the software downloading and how install it on the Host computer.

Connection diagram

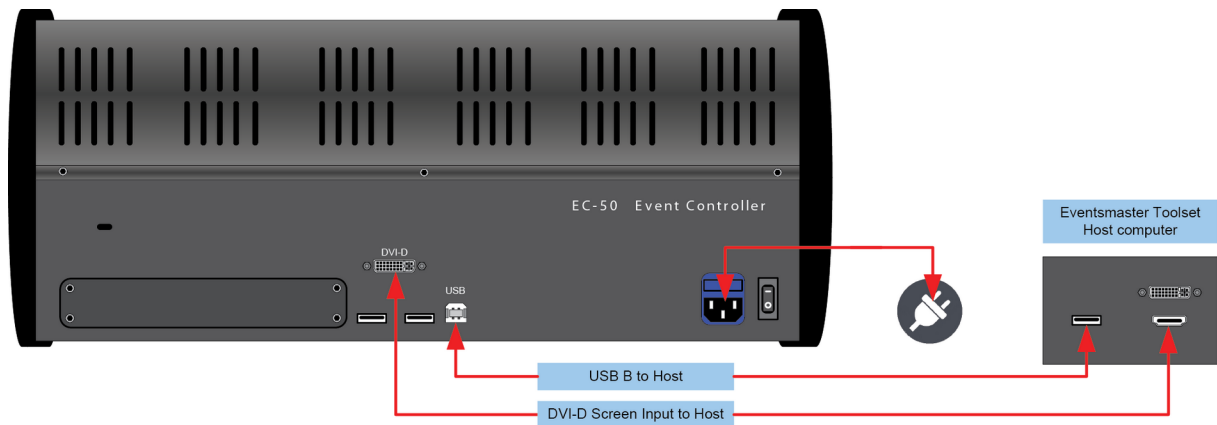

Image 11-2
EC-50 connections

Description

Connect the external screen and USB communication from the host computer to the DVI and USB B connector on the EC-50.

Plug the cord to the power outlet.

Necessary cables are provided in a new system. In the case that the original cables are missing, simply use standard computer cabling to make these connections.

11.4 EC-200 controller connection

Prerequisites

EC-200 is delivered with Event Master Toolset revision 3.0 or higher.



Verify that the EC-200 is equipped with the latest software version available on the Barco web site (URL: <https://www.barco.com>). Refer to the chapters "Download of Event Master Toolset Software", page 100 and "Software installation", page 101 for more information on the software downloading and how install it on the controller.

Connection diagram

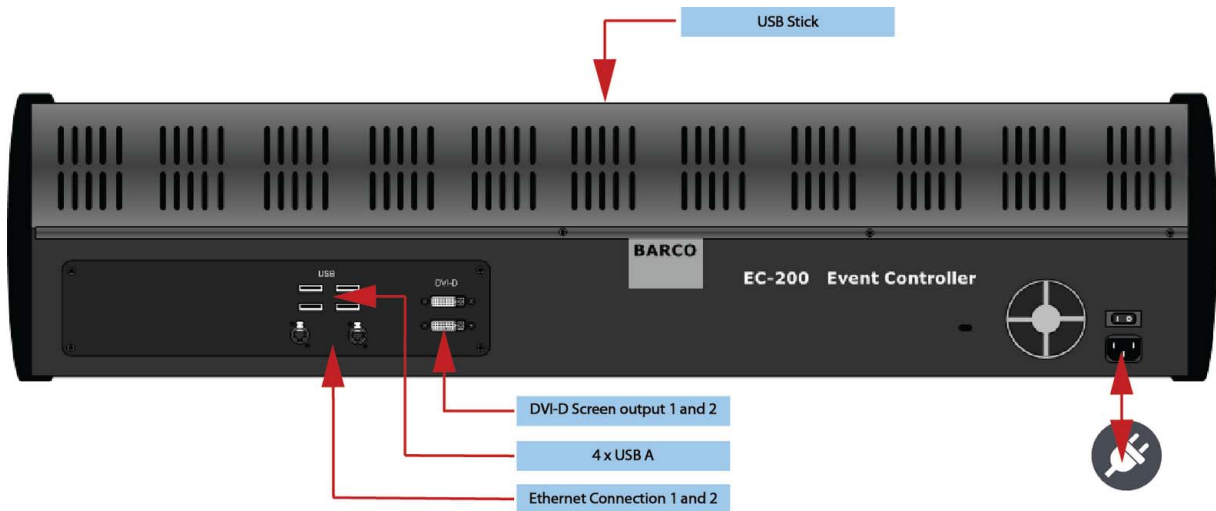

Image 11-3
EC-200 connections

Description

Connect the network outlet 1 to your Event Master Device Network for static IP address and outlet 2 for a DHCP assigned IP address. Plug the cord to the power outlet. Necessary cables (except a network cable) are provided in a new system. In the case that the original cables are missing, simply use standard computer cabling to make these connections.

The 4 USB connectors in the back can be used for keyboard and mouse and other supported USB devices. The USB connector in the middle of the top of the console is on delivery fitted with a USB memory.

11.5 Touch screen calibration

General

This feature depends on the controller type:

EC-50

The EC-50 need a host computer. Calibration of the touch screen could be necessary when your touch screen responds inaccurate or erratic.

EC-200

The EC-200 has 2 integrated capacitive touchscreens who do not need calibration. If they don't behave properly there can be dirt between the surface of the screen and the cover.

EC-50 Touch Screen calibration



Image 11-4

The operating system on the host computer provides this capability as it would for any standard touchscreen. Refer to the OS manual for the correct procedure.

11.6 Lights

EC-50 Overview



Image 11-5

- 1 Work Light
- 2 White Light
- 3 Red Backlight

EC-200 Overview

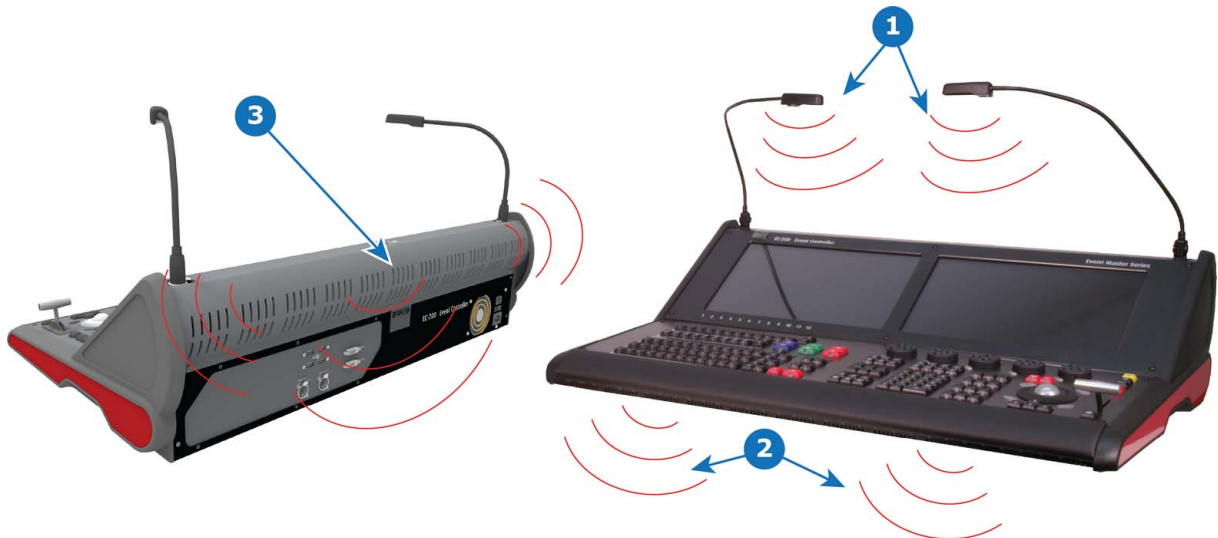

Image 11-6

- 1 2 x Work Light
- 2 White Light
- 3 Red Backlight

Description

Work Light

EC-50 and EC-200 controllers are respectively supplied with one and two flexible scriptlight connections equipped with LED light. Light can be adjusted for brightness in the Events Master Toolset Settings menu page in the tab User Prefs, only available when hardware is connected.

White light

White light under the hand rest is for reading show scripts. Light can be turned on and off in the Events Master Toolset Settings menu page in the tab User Prefs, only available when hardware is connected.

Red backlight

The Red backlight indicate that the power is on and is a design element. Light can be turned on and off in the Events Master Toolset Settings menu page in the tab User Prefs, only available when hardware is connected.

11.7 Assigning resources to the desk

Overview

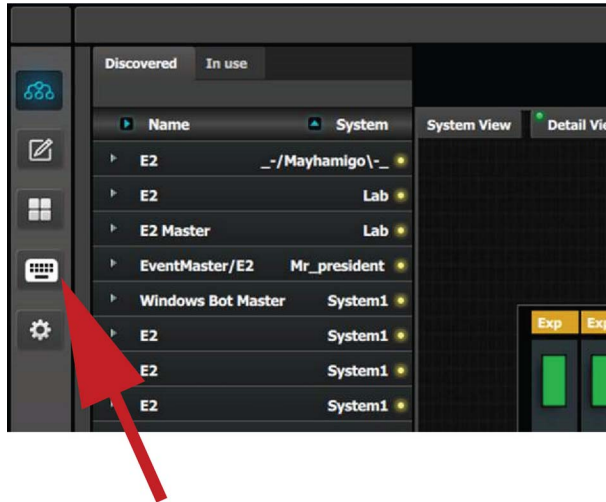

Image 11-7

In the Event Master Toolset, click on the  icon to open the controller menu setup page.

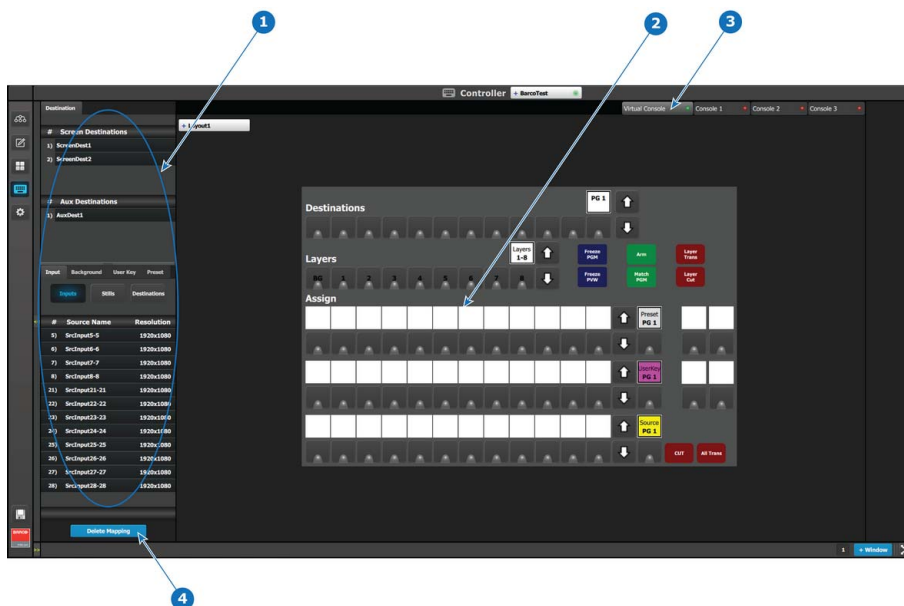

Image 11-8

- 1 Resources
- 2 Virtual console
- 3 Console Representation Selection
- 4 Delete Mapping button

How to Assign resources

Drag and drop the resources from the right side onto the buttons corresponding to the ones on the console.

How to remove incorrect mapping

In the case a wrong mapping is done, a **Delete Mapping** button in the lower part of the resource pane is available. When this button is clicked on it will turn in red. Now select the button with the incorrect mapping.

How to use the Console Representation Selection

There are four tabs with a bullet indication, Green means available and Red unavailable. The Virtual console is always available for use in Event Master Toolset. When a EC-50 is connected or if a EC-200 is used the first tab is also available.

The assigned resources are separate from each tab. However the assignment is transparent from the Virtual Console to the connected EC-50 or the left Side of the EC-200. Once the Tab representing the EC-50 / 200 is selected and more mapping is done, it will differ from each other.

This allow to use the resource assignment page as a second tactical input.

12. CONTROLLER OPERATION

About this chapter

This chapter describes the proper usage of the EC-30, EC-50, and EC-200 controllers. The left-hand side of the EC-200 and the EC-50 are identical in operation.

Overview

- General Overview
- EC-200 Firmware Upgrade
- How to power down the EC-200
- How to reboot the EC-200 CPU
- How to select destinations
- How to use the Layer buttons
- What are Layer executers?
- How to use assign Buttons
- How to use the page arrow buttons
- How to use transition buttons
- How to use the T-bar
- How to use the Contextual Display Buttons
- EC-200 Philosophy
- Function Button For Syntax
- Additional direct access and functionality

12.1 General Overview

Overview

The layout of the keyboard of the EC-30, the EC-50, and the left-hand side of the EC-200 is designed to give direct access to memories and selections in a live situation.

Programming, Playback, and Edit of any given event is greatly sped up, enhancing the abilities of an operator to react quickly to any given situation.



Image 12-1
Event Master controllers

12.2 EC-200 Firmware Upgrade

General

The EC-200 controller firmware can be updated through the Web App in the Settings Menu > Controller > Software tab. Please refer to "Settings Menu > Web App area > Tools > Manage Software", page 236 for instructions on how to perform a firmware upgrade through the Web interface.

For more information on upgrading the EC-200 firmware, see *InfoT-1322: Upgrading the Firmware and Operating System on the EC-200 Controller* on the Technical Downloads tab of the EC-200 Large event controller web page (URL: <https://www.barco.com/en/Products/Image-processing/Presentation-switchers/Large-event-controller.aspx#!downloads>).

12.3 How to power down the EC-200

General

Because repeated hard power cycling over time may lead to corruption of the solid-state drive (SSD), all versions of the EC-200 Event Master Toolset, version 4.0.29026 or higher, have a power-off soft button on the touchscreen.

Description

The power-off soft button is above the save button on the Menu navigation bar. See image 12-2 for the location of the power-off soft button.

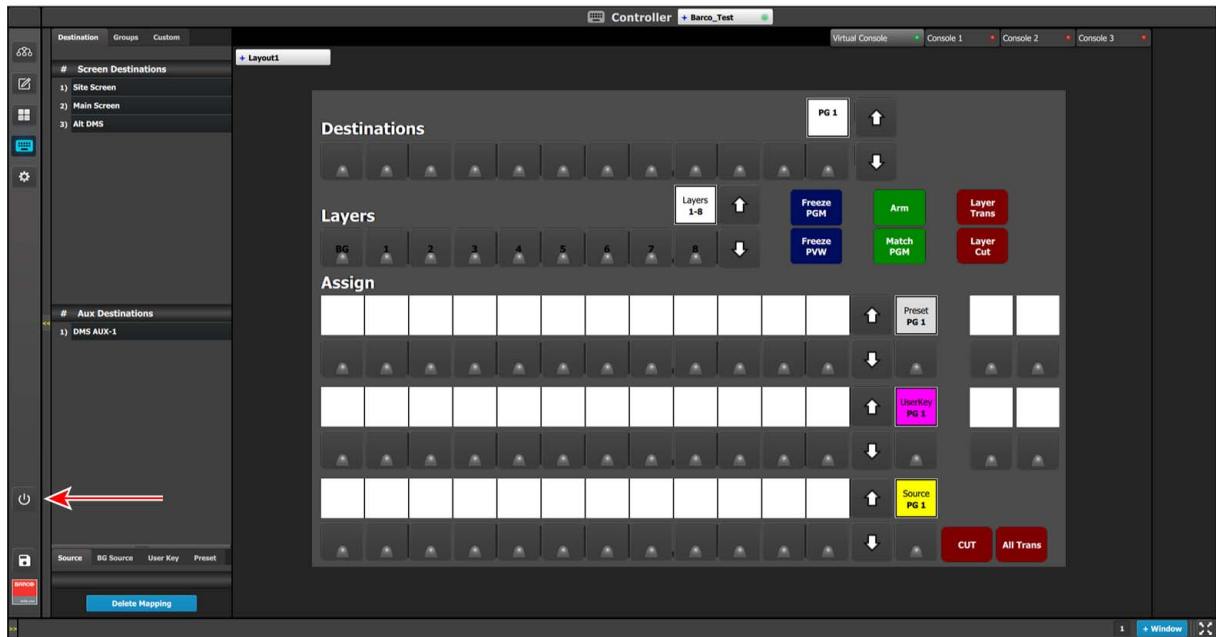



Image 12-2
Soft-Off button on the EC-200 GUI

To shut down the EC-200 console ...

1. Click on the power-off soft button  in the Menu navigation bar.
2. Select **PowerOff** in the confirmation window.

The user must power cycle the main (hardware) switch to power on the console. There is no soft PowerOn button.

For more information on the power-off soft button and SSD recovery, see *InfoT-1325: SSD Recovery on the EC-200 Controller* on the Technical Downloads tab of the EC-200 Large event controller web page (URL: <https://www.barco.com/en/Products/Image-processing/Presentation-switchers/Large-event-controller.aspx#downloads>).

12.4 How to reboot the EC-200 CPU

General

Press simultaneously and hold the **Capture Still** button, the **Barco Eye** button, and the top, left button in the Future Expansion Button Group to reboot the EC-200 CPU. These buttons are circled in image 12-3.



Image 12-3
EC-200 CPU-reboot key combination

12.5 How to select destinations

General

Once the row of Destination buttons have been mapped they can be used to select or deselect them.

A range of actions can be performed with this selection:

- Transition via Cut or All-Trans.
- Included in the record of a Preset;
- Prepare the destination for Layer manipulation.
- Change time of the destinations Transition. Note: time is assigned to each destination individually.

In general it can be said that the selected Destination via the console have the same actions available as in the Event Master Toolset, just in a more hands-on direct way.

12.6 How to use the Layer buttons

General

Similar to the Destination Buttons the Layer buttons create a selection for further actions.

Buttons are as standard in the same select mode as the destinations, latch on, latch off. Other modes will be available.

A range of actions can be performed with this selection:

- Assign a Source file via the Assign buttons in Source mode.
- Layer Transition or Cut via the Red Layer Executors to the right of the Layer button row.
- Freeze via the Blue Layer Executors to the right of the Layer button row.
- Arm via the Green Layer Executors to the right of the Layer button row.
- Match Program via the Green Layer Executors to the right of the Layer button row.

In general it can be said that a layer selection via the console have the same actions available as in the Event Master Toolset, just in a more hands-on direct way.

If a layer is not on preview or program, pressing the button will turn the layer on in preview and select it for modification.

Once on PVW only the clear button in the GUI or on the right side of the controller will remove the layer from PVW.

12.7 What are Layer executers?

General

These are the buttons to the right of the Layer Buttons, the function of them is described in context above and in detail below.

Freeze PGM

Button Freezes program of selected Layer(s) of the selected destination(s), blue LED when active.

Press again to release freeze.

Freeze PVW

Button freezes preview of selected Layer(s) of the selected destination, blue LED when active.

Press again to release freeze.

Arm

Button arms effects on selected layers in all selected destinations.

Indication of armed FX on PGM, red LED.

Indication of armed FX on PVW, green LED.

Match

Match the selected layer in Preview to its corresponding layer in Program.

Button matches the function of Match Program in the GUI.

Blinks red when pressed.

Can be used across multiple layers and destinations.

Layer Trans

Transitions Selected Layers into Program, based on # of frames set for the layer in the GUI.

Button matches the function of Trans in the GUI below the workspace.

Layer Cut

Cut selected layer into Program.

Button matches the function of CUT in the GUI below the workspace.

12.8 How to use assign Buttons

General

The Assign buttons are three rows of the same, allowing for quick recall of a memory or resource.

Each row can be selected independently to several memory types.

Currently available assignment are:

Source

Recalls the mapped Source file into the Layer Selection.

User Key

Recalls the mapped User Key to the selected layer.

Preset

Recalls the mapped Preset to the whole Preview.

BG Source

Recalls the mapped BG to the selected Destination.



If LIVE mode is activated the above actions happens to the Program instead of the Preview.

12.9 How to use the page arrow buttons

General

Each row of **Assign** buttons has a display that shows the active page and in addition **up and down arrow** buttons that are used to change pages.

Up and **down** increase or decrease the page number.

In the case of many pages there is a fast jump button combination.

As a fast access to bigger jumps in the pages a button combination is available.

Press and hold the **up** or **down** button and then press a button on the assign row. The Button 1 jumps to page 10, button 8 to page 80 and consistent throughout the buttons.

A quick return to page 1 is also possible via holding the **Barco Eye** and tapping **Arrow Down**.*

(*) These functionality are not available on the EC-50.

12.10 How to use transition buttons

General

There are two types of transitional triggering:

All-trans

The **All-trans** (Transitions All) is the way to start a timed transition of Destinations. It transitions the set up pre-view into program.

In the case a transition is not completed it can be reversed.

A manually started transition can be finished with an All-Trans command and an All-Trans can be finished with the T-bar.



Only selected destinations will be concerned. The unselected destinations are not affected by the transition.

Cut

Cut perform the same action as the All-Trans but with zero time.

12.11 How to use the T-bar

General

The **T-bar** is the way to manually transition Destinations. It works both ways to transition the set up pre-view into program. In the case a transition is not completed it can be reversed. A manually started transition can be finished with an All-Trans command.



Only selected destinations will be concerned by the T-bar use. The non selected destinations are not affected by the transition.

12.12 How to use the Contextual Display Buttons

General

The 4 contextual display buttons to the right of the Assign Buttons are used for several tasks and can be mapped for different functions in the Console Menu page.

12.13 EC-200 Philosophy

General

The EC-200 introduces a new way of programming a Video controller in parallel with a more traditional way. In order to understand what is possible a small session on philosophy is in order.

About the EC-200 programming

The use of a control system is typically divided in the following major tasks:

1. Configuration and Setup of Unit and System.

This part is not, in general, covered on the controller surface. The System Configuration tab can be opened on the screen in the controller for the buttons, but entry and settings is limited to touch screen and mouse/trackball interaction.

2. Programming creation/edit.

- Creation is when information is added into the system
- Edit is when information is edited in memories to then be saved back

3. Execution playback/live control-edit.

- Playback is when memories and cues are recalled to be executed
- Live control is when memories are recalled and overridden or added to with direct interaction, either in Preview (normal) or direct on program if LIVE is selected.



Programming will typically happen on the right side of the desk, and Execution will still be possible to the left, like selecting Layers and sources and record presets. User is of course free to mix these concepts after own preferences.

A word about the hardware

There are two main parts in the EC-200 controller. The Left side is dedicated to the industry's feedback on many buttons and Encore like presentation switching. The Right side is inspired by some of the ideas from the lighting industry, which has a much longer tradition of managing large numbers of instruments. We will need this in order to effectively use our E2 and its family members, including other devices like projectors and playback devices.

General guide lines

Selection

By using the **Num pad** of the console we will allow for the selection of several parts of the system and once selected allow them to be manipulated (apply an action via function buttons).

The primary group of Function Buttons are located just above the Num Pad.

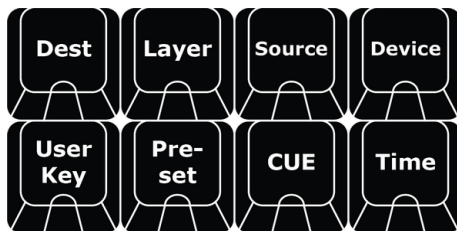



Image 12-4

The following buttons are available:

Button	Description
Dest	Destination refer to the most downstream location in the chain, usually a screen.
Layer	Layer refers to a layer that can hold live video.
Source	Source refer to an image source such as a Sourcefile, Still store and more.
Device	Device refers to devices in an Event Master System.
Preset	Preset refers to Presets stored in Event Master Toolset.
User Key	User Keys are building blocks of settings for the Layers.
Time	Time refers to the timing parameter of the selected Top Functions.
Cue	Cue refers to Cues stored in Event Master Toolset.

With these function buttons a syntax can be applied to make a selection that is then used for further action.

By example, a selection can be made like:

DEST 1 ENTER	 +  + 	This syntax will Select the Destination 1, just like clicking on the Tab in the destination.
--------------	---	--

Further there are modifiers to the syntax:

DEST 1 + 3 ENTER	 +  +  +  + 	This syntax will select Destination 1 and 3.
------------------	---	--

Or:

DEST 1 Thru 3 ENTER	 +  +  +  + 	This syntax will select Destinations 1 thru 3.
------------------------	---	--

You can probably see how efficient this is when you have lots of destinations.

Your modifiers are:

– , +, **Thru** to add or subtract from the selected function.



There are several examples below in this manual to understand how this can work in favor of the user.

Numbering

Destination, Layer, Source, Cue, Preset, and Userkey all have a number and a name that are independent from each other. The Default name include the number, but does not need to remain in order to recall over syntax.

There are further functions that can be controlled with syntax like screens, layouts and such. This is further described below.

There are also a range of combined button presses that is meant to speed up the programming and control.

Contextual Buttons



Image 12-5

The 12 Contextual Buttons to the left of the NumPad is used to add situational functionality to the syntax. Certain button presses changes the displays naming and the buttons function. They are referred to as CD1 thru 12 per row from the top left.

General rules

Note that all possible syntax is not supported.

A few general rules:

- Any Syntax entry must end with **ENTER**.
- Any Syntax is max 3 Functions deep before **ENTER**.
- In the case of unsupported syntax it will just not work or register.



The Syntax Feedback line in the Controller Menu Page is a huge help to understand what is supported and not.

12.14 Function Button For Syntax

Destination



Image 12-6

Destination refers to the most downstream location in the chain, usually a screen. See the earlier Chapters for the definition of Destination.

When **DEST** is pressed it lights its blue LED and opens the syntax entry for numbers and modifiers as per above.

The contextual Buttons to the right of the numpad also light up and is populated with functionality that can be used in the syntax. These are:

Contextual Button	Display	Description
CD1	AUX	<ul style="list-style-type: none"> DEST + AUX # ENTER select the Aux #, just as clicking it in the GUI. DEST + AUX 1 + 2 + 5 ENTER will select Aux 1, 2 and 5. DEST + AUX - 2 ENTER will unselect Aux 2, but 1 and 5 stays selected DEST + AUX CLEAR will unselect all Aux Destinations
CD2	BG Input	Once pressed allows for assigning BG Input via number entry on keypad. 0 is Matte and maps the WH1 Red, WH2 Green, WH 3 Blue
CD3	Empty	
CD4	Empty	
CD5	Empty	
CD6	Empty	
CD7	Toggle	Activate Toggle mode on selected destinations BG on/off .
CD8	Transition curve	will toggle between Linear / S-curve / Log / Exp.
CD9	Empty	
CD10	Empty	
CD11	Freeze PGM	Freezes Program in selected Destinations including Sources and Backgrounds.
CD12	Empty	

Layer



Image 12-7

Layer refers to a layer that can hold live video. See the earlier Chapters for the definition of Layer.

When **LAYER** is pressed it lights its blue LED and opens the syntax entry for numbers and modifiers as per below:

- LAYER # ENTER will select LAYER #, just as clicking it in the GUI.
- LAYER 1 + 3 + 5 ENTER will select LAYER 1, 3 and 5 just as clicking it in the GUI with Multiple Select on.
- LAYER - 3 ENTER will unselect LAYER three, but 1 and 5 stays selected just as clicking it in the GUI with Multiple Select on. Multiple Select for Layers does not really apply to this way of selection.
- LAYER CLEAR will deselect all layers.

The contextual Buttons to the right of the numpad also light up and is populated with functionality that can be used in the syntax. These are:

Contextual Button	Display	Description
CD1	PIP	Selects selected Layer as PIP, indicates that by color Green backlight.
CD2	KEY	Selects selected Layer as KEY, indicates that by color Red backlight.
CD3	Empty	

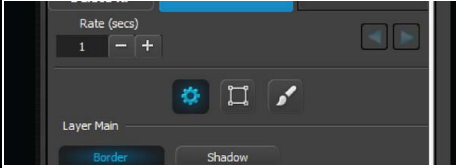
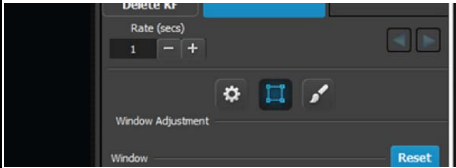
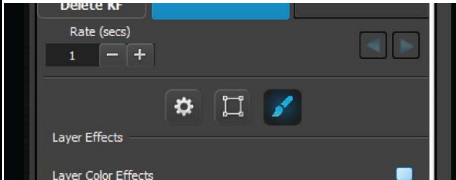
Contextual Button	Display	Description
CD4	Main	Thumbnail like GUI "Sprocket". Selected layer Adjustment area is indicated by light blue backlight. Selects and open the Layer Main area: 
CD5	Window	Thumbnail like GUI "Box" Selected layer Adjustment area is indicated by light blue backlight Selects and open the Window Adjustment area: 
CD6	Effects	Thumbnail like GUI "Brush" Selected layer Adjustment area is indicated by light blue backlight Selects and open the Layer Effects area: 
CD7	Layer Time	Assigns transition time for the layer like: Currently selected layers/s is assigned the time, in frames for a Layer Transition. Ends with Enter.
CD8	Border off / on	
CD9	Shadow off / on	Toggles Border setting of selected layer on vs off
CD10	Reset	Same as Reset in GUI
CD11	Full H	Same as in GUI
CD12	Full V	Same as in GUI

PAGE 2 via **PG Down** (Page 1 via **PG Up** respectively) :

Contextual Button	Display	Description
CD1	Add Keyframe	Adds Keyframe to selected Layers.
CD2	Delete Keyframe	Deletes Keyframe of selected Layers.

Below layer functions will map per below:

TB/R	H Pos / V Pos / Size of selected layer We will use the ring on the trackball for size, the mod buttons will toggle between H/V or H & V
WH 1	H Pos
WH 2	V Pos
WH 3	Size H
WH 4	Size V



The Rotary Encoders mapping will continue as suggested above but out of scope for R1.

Arrow Buttons

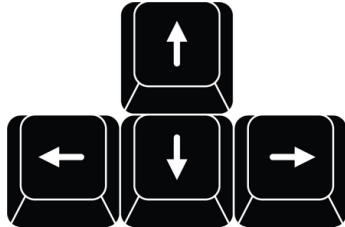

Image 12-8

The standard function is moving a layer just as in EMTS now.

When the Barco Eye Button is pressed and held the arrow buttons will allow for Z-Order alignment, selected layers will move one Z-order up or down according to the arrow indication- Left arrow is top most Z-order Right arrow is bottom most Z-order.

Source



Image 12-9

Source refer to an source of image or video such as a Source file, Still store and Destination. See the earlier Chapters for the definition of Source.

When Source is pressed it lights its blue LED and opens the syntax entry for numbers and modifiers as per above and in detail below:

- SOURCE # ENTER will add Source file # to the selected layer or add a layer, just as dragging it in the GUI.
- SOURCE 1 THRU 4 ENTER will add Source file 1 to the Z-order first selected layer and continue to add source files 2 – 4 to Z-order layers 2 – 4 or add as many layers needed until no layers are available.
- SOURCE 1 + 5 + 88 ENTER will add Source file 1 to the Z-order first selected layer and continue to add source files 5 and 88 to Z-order layers 2 – 3 or add as many layers needed until no layers are available.
Note: SOURCE syntax support the . (dot) as indicating a source file like 88.5



For live input sources, Source is the actual source file, not the input in number.

The contextual Buttons to the right of the numpad also light up and is populated with functionality that can be used in the syntax. These are:

Contextual Button	Display	Description
CD1	RESET Size	Once pressed Resets the Sizing Adjustments of the source in the selected Layer, just as clicking the Blue Reset icon button in the GUI. If multiple layer are selected, no source files sizing is Reset.
CD2	Create Source (file)	Creates new source file just like the plus button in the GUI
CD3	SAVE Source	Saves the source file
CD4	Sprocket Source Adjustment	Opens the Adjust of the selected source on the Sprocket page.
CD5	Brush Color correction	Opens the Adjust of the Color correction of the selected source on the Brush page
CD6	Empty	
CD7	Snowflake (Freeze input)	Will freeze the INPUT of the selected source file. If the selected source IS frozen it will be un-frozen.
CD8	Bind	Binds Source file to User key per syntax. SOURCE # (is source file) BIND # (is user key number) ENTER
CD9	Empty	
CD10	Empty	

Contextual Button	Display	Description
CD11	Empty	
CD12	Empty	

Device



Image 12-10

Device refers to devices in an Event Master System.

User Key



Image 12-11

User Keys are building blocks of settings for the Layers. See the earlier Chapters for the definition of user Keys.

When User Key is pressed it lights its blue LED and opens the syntax entry for Record and Recall of user keys.

Recording of a Preset is done in conjunction with the Save PVW and Save PGM Buttons like below:

- USERKEY # ENTER will recall userkey # to all selected layers.
- USERKEY 5 + 11 + 7 ENTER will add userkey 5 to the Z-order first selected layer and continue to add userkey 11 and 7 to Z-order layers 2 – 3

To record userkeys you can only have one Destination and one Layer selected. Recording a userkey is done via the below syntax:



Image 12-12

- SAVE PVW USERKEY # ENTER will save the currently selected layer properties in Preview into the selected number. If the number exists we overwrite.
- SAVE PGM USERKEY # ENTER will save the currently selected layer properties in Program into the selected number. If the number exists we overwrite.
- USERKEY ENTER saves next available userkey.

The contextual Buttons to the right of the numpad also light up and is populated with functionality that can be used in the syntax. These are:

CD1 -10	is the Enables and toggles on off
CD12	is All / None as toggle function



Enables of the User Keys are described in an earlier chapter.

Preset



Image 12-13

Preset refers to Presets stored in Event Master Toolset. See the earlier Chapters for the definition of Presets.

When **Pre-set** is pressed it lights its blue LED and opens the syntax entry for Record and Recall of user keys.

Recording of a Preset is done in conjunction with the **Save PVW** and **Save PGM** Buttons like below:

12. Controller Operation

- PRESET # ENTER will recall preset #
- PRESET 5 + 11 + 7 ENTER recall these presets in order, 5 being recalled first in a stack on fashion, information is added but not replaced.

Recording a preset is done via the below syntax:

- SAVE PVW PRESET # ENTER will save the currently selected destination/s into the selected number. If the number exist we overwrite.
- PRESET ENTER without a # saves next available preset.

The contextual Buttons to the right of the numpad also light up and is populated with functionality that can be used in the syntax. These are:

Contextual Button	Display	Description
CD1	Lock / Unlock	Locks and unlocks the Selected Preset
CD2	Renumber	Renumber the Selected preset

Example:

- PRESET 45 Renumber 55 ENTER will renumber Preset 45 to 55.

Special Function with Modifiers with Preset recall and Record:

- + numpad will increase selection by one.
- - numpad will decrease selection by one.

Cue



Image 12-14

Cue refers to Cues stored in Event Master Toolset.

Time



Image 12-15

Time refers to the timing parameter of the selected Top Functions. This button will allow entering time for different functions.

Destination has Transition Time, Layer has Layer Transition Time.

Syntax for TIME is:

- DEST # TIME # ENTER will set the Transition time of 60 to Destinations # but not select Destination # further actions.
- DEST 1 + 5 TIME 60 ENTER will set the Transition time of 60 to Destinations 1 and 5 but not select Destination 1 and 5 for further actions.
- LAYER 1 + 4 TIME 120 ENTER will set the Layer Transition time of 120 to Layer 1 and 4 but not select Layer 1 and 4 for further actions.

12.15 Additional direct access and functionality

HELP Err



Image 12-16

The **HELP / Err** button is not functional at this point. Once functional it will open FAQ and such functionality.

Layout



Image 12-17

The **Layout** function button allows for selection and recall of layouts where applicable.

Multi-viewer, Assign Buttons and Programmer screen & Preset screens are currently implemented.

To select a Layout use syntax like:

- LAYOUT 1 ENTER will recall Layout 1.

The same number of layouts is available as in the GUI. Layout changes also act as they do in the GUI.

When a layout is selected changes are stored for that layout in real time, automatically.

Pressing **Layout** button will populate the Smart Displays with:

Contextual Button	Display	Description
CD1	MVR	LAYOUT MVR (CD1) 1 or 2 or 3 or 4 ENTER will recall Layout 1 – 4 respectively into the Multi-viewer
CD2	Programing	LAYOUT Programmer (CD 2) 1 or 2 or 3 or 4 ENTER will recall Layout 1 – 4 respectively into the Programming Window
CD3	Assign Buttons	LAYOUT Assign (CD 3) 1 or 2 or 3 or 4 ENTER will Recall Layout 1 – 4 respectively into the Assign Buttons.

Screens



Image 12-18

The **Screens** button is used to select the windows of the GUI currently in the displays of the controller. There is 2 internal standard and 2 external possible.

Screens are named 1 – 4, 1 to the left and 2 to the right with the output 3 and 4 in the back.

When the **Screens** button is pressed, the contextual displays will be populated with:

Contextual Button	Display	Description
CD1	Config 1	Applies the Config Page to the left screen of the console
CD2	Program 1	Applies the programming page to the right screen of the console
CD3	MVR 1	Applies the MVR Setup page to the Left screen of the console
CD4	Config 2	Applies the Config Page to the right screen of the console
CD5	Program 2	Applies the programming page to the right screen of the console
CD6	MVR 2	Applies the MVR Setup page to the Left screen of the console
CD7	Console 1	Applies the Console Setup page to the Left screen of the console
CD8	Web 1	Applies the Web preset page to the Left screen of the console
CD9	Blank	
CD10	Console 2	Applies the Console Setup page to the Left screen of the console
CD11	Web 2	Applies the Web preset page to the Left screen of the console
CD12	Dest Show/Hide	Reveals or hides the Destination banner in the Left screen

PAGE 2 via **PG Down** (Page 1 via **PG Up** respectively):

Contextual Button	Display	Description
CD1	Config 3	Applies the Config Page to the left screen of the console
CD2	Program 3	Applies the programming page to the right screen of the console
CD3	MVR 3	Applies the MVR Setup page to the Left screen of the console
CD4	Config 4	Applies the Config Page to the right screen of the console
CD5	Program 4	Applies the programming page to the right screen of the console
CD6	MVR 4	Applies the MVR Setup page to the Left screen of the console
CD7	Console 3	Applies the Console Setup page to the Left screen of the console
CD8	Web 3	Applies the Web preset page to the Left screen of the console
CD9	Blank	
CD10	Console 4	Applies the Console Setup page to the Left screen of the console
CD11	Web 4	Applies the Web preset page to the Left screen of the console
CD12	Dest Show/Hide	Reveals or hides the Destination banner in the Left screen

Save PVW (Save Preview)



Image 12-19

Once pressed this button latches the function “Save from PVW Mode” and lights its GREEN led. This allow storing 1 or several Templates / Presets or Cue’s after the syntax from Preview.



When the LED is RED, it indicates that the Save PGM button turned the EC-200 in “Save PGM Mode”.

Example of use:

- PRESET # ENTER → Preset # is stored from Preview as new preset.
- PRESET # ENTER → Preset # is **overwritten** from Preview if it exists.
- PRESET ENTER → Next free preset number is created from Program.

If either **Save PVW** or **Save PGM** is latched and the other is pressed it cancels the previous latch.

The GUI Button **Save PVW** will turn red to indicate the latched record state.

Save PGM (Save Program)



Image 12-20

Once pressed this button latches the function “Save from PGM Mode”. This allows storing 1 or several Templates / Presets or Cue’s after the syntax from Preview.



As the Button does not have a LED internally it will light up the LED of the Save PVW button in Red.

Example of use:

- PRESET 5 ENTER → Preset 5 is stored from Program as new preset.
- PRESET 5 ENTER → Preset 5 is **overwritten** from Program if it exists;
- PRESET ENTER → Next free preset number is created from Program.

If either **Save PGM** or **Save PVW** is latched and the other is pressed it cancels the previous latch.

As the Button for Save PGM does not have an internal LED the GUI also must indicate that the button is latched. The GUI Button Save PGM will turn red to indicate the latched record state.

Adjust



Image 12-21

The **Adjust** button provides a shortcut to and open the Adjust tab of the Selected function.



If nothing is selected that has information that goes in the Adjust tab, it will still open and be empty.

All Dest



Image 12-22

All Dest provides a shortcut to selects all Destinations for further actions. And with Press and Hold have extended function.

A Single press selects all destinations.

When pressed and held and then button **CLEAR** is tapped, All Destinations are un-selected.

When pressed and held and then button **BARCO EYE** is tapped, the selection is inverted.

All Layer



Image 12-23

All Layer provides a shortcut to selects all Layers of selected destinations for further actions. And with Press and Hold have extended function.

A Single press selects all Layers.

When pressed and held and then button **CLEAR** is tapped, All Layers of selected Destinations are un-selected.

When pressed and held and then button **BARCO EYE** is tapped, the selection is inverted.

Clear



Image 12-24

The **Clear** button has many functions and clearing selections and operands are often used in programming. Most of the CLEAR functionality has been included with each button and is not repeated here. The simplest function of CLEAR is:

- Clears the current selection of the latest selected DEST / LAYER / SOURCE / DEVICE to unselected.

After that it becomes more of a modifier with other buttons.

PVW Trans



Image 12-25

Currently selected layers in Preview will preview its effect (move) without showing on program.

Capture Still



Image 12-26

With the **Capture Still** Button a Still Store can be captured via syntax. The Source File numbers input will capture.

Syntax:

- SOURCE # Capture Still



As a Direct select function it does not require ENTER in the end

Barco Eye



Image 12-27

The **Barco Eye** button works as a Modifier Button, like Windows/CTRL/Fn button on a keyboard. This is further described in functionality around other buttons.

Mod PGM (Modify Program) [Red button cap]



Image 12-28

Pressing button Unlocks Selected Destinations Program for Edit just as clicking the small lock in Program.

Red LED indicates active.

Live [Red button cap]



Image 12-29

The **Live** button latches and Red LED indicates active.

When the live function is active the Assign Key Source BUS or the Syntax actions regarding LAYERS/SOURCE/PRESET/USER KEY are applied in the PROGRAM as opposed to the normal PREVIEW BUS.

LAYER

Layer Selection is made on PROGRAM.

SOURCE

Actions on layer SOURCE ONLY are executed on Program.

PRESET

Presets recalled with syntax and Assign Button are applied in Preview and transition direct to Program.

USER KEY

Userkeys recalled with syntax and Assign Button are applied direct in Program.

T-Bar Disable



Image 12-30

This button allows disables the T-Bar.

Red steady light when active.

All Trans [Red button cap]



Image 12-31

Same function as the All Trans on the Left side.

Save All [Yellow button cap]



Image 12-32

To save the show into the current state the user presses this button. It is the same as the Disk button in GUI. Confirmation is given in the bottom signal bar in red Save Done.

Panel lock



Image 12-33

By pressing the **Panel Lock** button the user lock's out the Panel and Touch Screens from input with Request for password to unlock.

Proceed like below:

- Press **Panel Lock** button.
- Once Locked all input from screens or panel result in a request for Password, 4 numbers from numpad + enter to unlock.



Standard Password to override all is 4096.

Keyboard



Image 12-34

Pressing this button enables or disables the On Screen Keyboard. This setting is found in the Settings Menu Page.

13. PREVENTIVE MAINTENANCE ACTIONS

Overview

- E2 maintenance actions
- S3 maintenance actions
- EX maintenance actions
- EC-30 maintenance actions
- EC-50 maintenance actions
- EC-200 maintenance actions

13.1 E2 maintenance actions

MAINTENANCE TYPE A (perform every month)



The monthly maintenance actions, listed below, may be performed by the user in accordance with the procedures described in the E2 Maintenance chapter.

No.	Maintenance action	Remarks
1	Clean the EMI filter.	<p>The EMI filter may be removed, but if it is left in the E2 processor, it should be cleaned monthly.</p> <p>Note: If a show has fog machines and the E2 processor has an EMI filter, cleaning the EMI filter is required after every show.</p>

MAINTENANCE TYPE C (perform every year)



The yearly maintenance actions, listed below, may be performed by the user in accordance with the procedures described in the E2 Maintenance chapter.

No.	Maintenance action	Remarks
1	Check battery valid date.	<p>If the date is older than 4 years, replace battery as a preventative measure.</p> <p>Note: When a new battery is installed, the user needs to place a sticker with the date on the inside of the metal plate (Bottom Panel) that indicates when the battery was last replaced. The absence of sticker means the battery has never been replaced. In this case the S/N sticker can be used for the reference date.</p>

13.2 S3 maintenance actions

MAINTENANCE TYPE C (perform every year)



The yearly maintenance actions, listed below, may be performed by the user in accordance with the procedures described in the S3 Maintenance chapter.

No.	Maintenance action	Remarks
1	Check battery valid date.	<p>If the date is older than 4 years, replace battery as a preventative measure.</p> <p>Note: When a new battery is installed, the user need to place a sticker with the date on the motherboard mount that indicates when the battery was last replaced. The absence of sticker means the battery has never been replaced. In this case the S/N sticker can be used for the reference date.</p>

13.3 EX maintenance actions

MAINTENANCE TYPE C (perform every year)



The yearly maintenance actions, listed below, may be performed by the user in accordance with the procedures described in the EX Maintenance chapter.

No.	Maintenance action	Remarks
1	Check battery valid date.	<p>If the date is older than 4 years, replace battery as a preventative measure.</p> <p>Note: When a new battery is installed, the user needs to place a sticker with the date on the motherboard mount that indicates when the battery was last replaced. The absence of sticker means the battery has never been replaced. In this case the S/N sticker can be used for the reference date.</p>

13.4 EC-30 maintenance actions



No preventive action is needed on this device.

13.5 EC-50 maintenance actions



No preventive action is needed on this device.

13.6 EC-200 maintenance actions

MAINTENANCE TYPE C (perform every year)



The yearly maintenance actions, listed below, may be performed by the user in accordance with the procedures described in the EC-200 Maintenance chapter*.

No.	Maintenance action	Remarks
1	Check battery valid date.	<p>If the date is older than 4 years, replace battery as a preventative measure.</p> <p>Note: When a new battery is installed, the user need to place a sticker with the date in the unit (on the rear of the chassis, near the Motherboard) that indicates when the battery was last replaced. The absence of sticker means the battery has never been replaced. In this case the S/N sticker can be used for the reference date.</p>
2	Remove dust accumulation	Remove dust accumulation from the CPU fan on the motherboard with a few short bursts of compressed air.

14. E2 MAINTENANCE

About this chapter

This chapter describes how to service the E2 by replacing individual components.

Simple servicing

E2 is based on a modular design that ensures easy serviceability. Users can swap most of the E2 components in the case of damage, without shipping the unit to a Barco service center.

Methodology

Most procedures in these chapters include multiple steps to gain access to the parts requiring service. A workflow flow chart is provided next indicating all of the procedures and their relationships. Please refer to the chart to familiarize yourself with the sequence of procedures.

ESD recommendations

The following precautions must be taken:

- Perform the Service procedures only at approved anti-static work station equipped with anti- static mat.
- At all times use a conductive wrist strap attached to a solid earth ground.
- Always discharge yourself by touching a grounded bare metal surface before coming in contact with ESD sensitive electronic.



WARNING: Always switch power off and unplug the cords from the device before performing any maintenance operations described in this chapter.



WARNING: The device can be damaged by electrostatic discharge (ESD). When handling the device and any of its components, caution must be taken so that damage does not occur. Damage due to inappropriate handling is not covered by the warranty.

Overview

- E2 unit Overview
- Process Overview
- Spare Parts Serviceable by All Users
- Rear I/O and Link Cards
- Rear I/O, VPU and Link card Heatsink Fan
- Front Cover Assembly
- Front Brackets
- 3RU Fan Tray
- 1RU Fan Tray
- VPU Card(s)
- Front Panel Knob
- Front Panel Mount
- Front Panel Board
- VFD Display Assembly
- VFD Display Filter
- Bottom Panel
- Solid-State Memory
- System Battery
- CPU Module
- Power Supply
- System-Power Board
- Genlock Assembly
- USB Cable
- USB Extension Cable
- VFD Cable
- Keyboard Cable
- Genlock Cable
- Ethernet Cable
- 3RU Fan Cable
- 1RU Fan Cable
- Rear Rack Ears
- Front Rack-Ears
- Top Cover
- Top Card Guide
- Motherboard Fan

14.1 E2 unit Overview

Orientation and main components

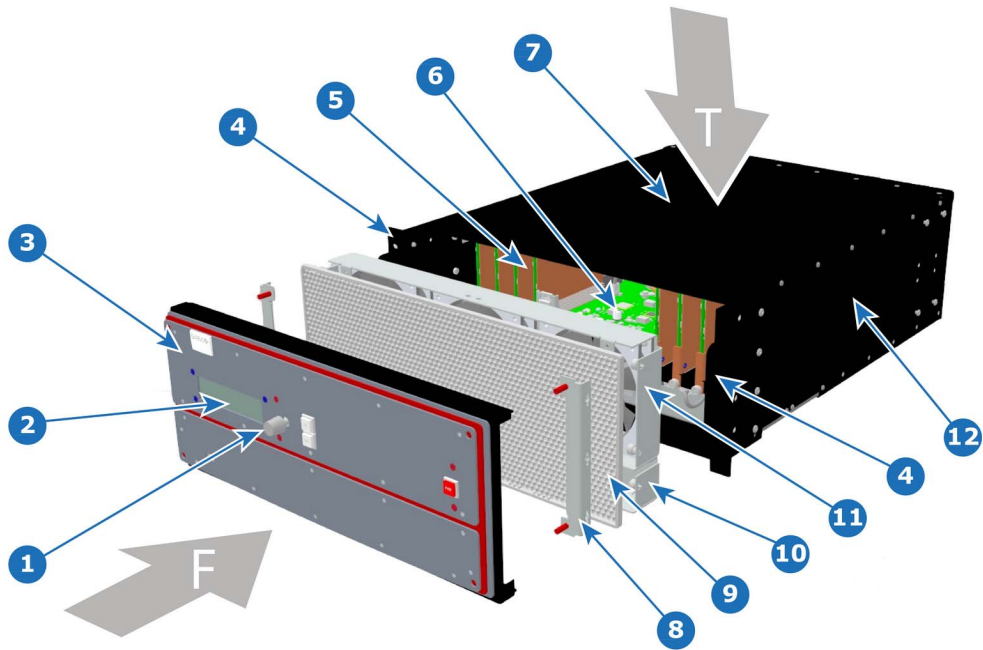

Image 14-1

T	Top	6	Mother Board
F	Front	7	Top Cover
1	Front Panel Knob	8	Front Brackets
2	VFD Display	9	EMI Filter
3	Front Cover Assembly	10	1RU Fan Tray
4	Rack Ears	11	3RU Fan Tray
5	VPU cards	12	Chassis

14.2 Process Overview

Flow chart

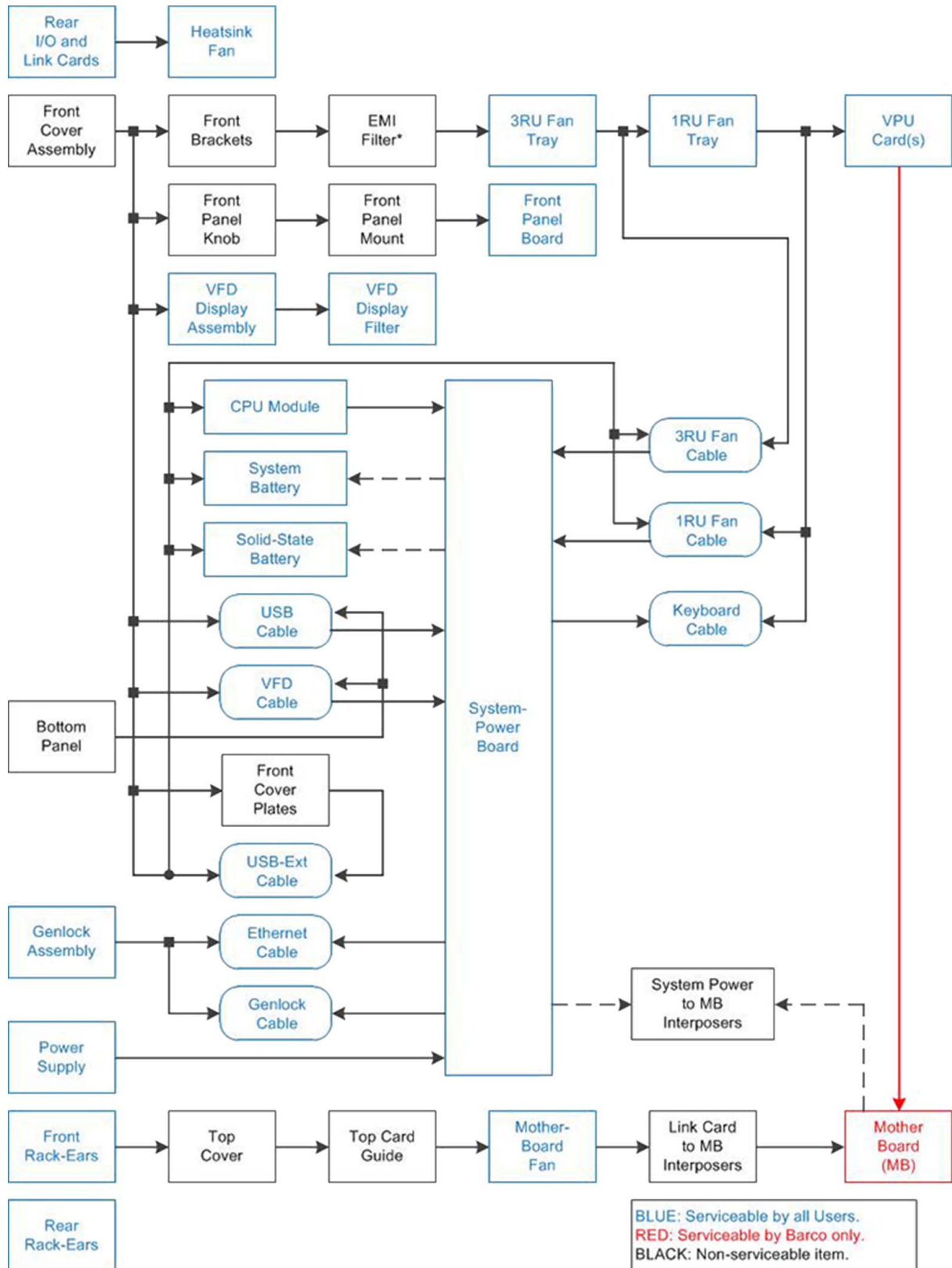

Image 14-2



The EMI filter is no longer needed, and it can be removed.

14.3 Spare Parts Serviceable by All Users

E2 Spare Parts list

P/N	Description	Comments
R767241K *	VFD Display assembly	
R767246K *	VFD Filter	
R767260K *	Front Panel board	
R767261K	System Power board	
R767263K *	Heatsink fan	One for each Input, Output, Link and VPU card
R767264K *	CPU module	
R767265K *	Motherboard Heatsink & Fan kit	
R767267K *	Power supply(PS)	One PS only. System accepts two Power supplies
R767268K	Front Rack ears	Includes hardware for both sides
R767269K	Cable Kit set	Kit Contains: <ul style="list-style-type: none"> • 1x VFD-to-System board cable • 2x Fan tray-to-System board cables • 1x Genlock-to-System flat cable • 1x Front Panel Keyboard-to-System flat cable • 1x RJ45-to-System CAT5 Ethernet cable • 1x USB-to-System 5-pin cable
R767270K	1RU fan tray	The fans are not available separately
R767271K (Obsolete)	3RU fan tray	The fans are not available separately — will be replaced by R767280
R767273K *	Rear Rack ears (Connector protector)	Includes hardware for both sides
R767275K *	Solid-State Memory	
R767280K *	3RU fan tray	The fans are not available separately — will replace R767271K
V327007 *	System Battery	
R9004740 *	DVI Input Board	
R9004741 *	SDI Output Board	
R9004742 *	SDI Input Board	
R9004743 *	HDMI Output Board	
R9004744 *	DP/HDMI Input Board	
R9004745 *	DVI Output Board	Not available in release 1
R9004746 *	Link Card Board	
R9004747	VPU Board	Internal board
R9004748	Genlock Board	
R9004750 *	Link/CXP Cable	
R9004785 *	Tri-Combo Input Board	
R9004786 *	Tri-Combo Output Board	

(*) common between E2 and S3.

14.4 Rear I/O and Link Cards

Flow chart



Image 14-3

Overview

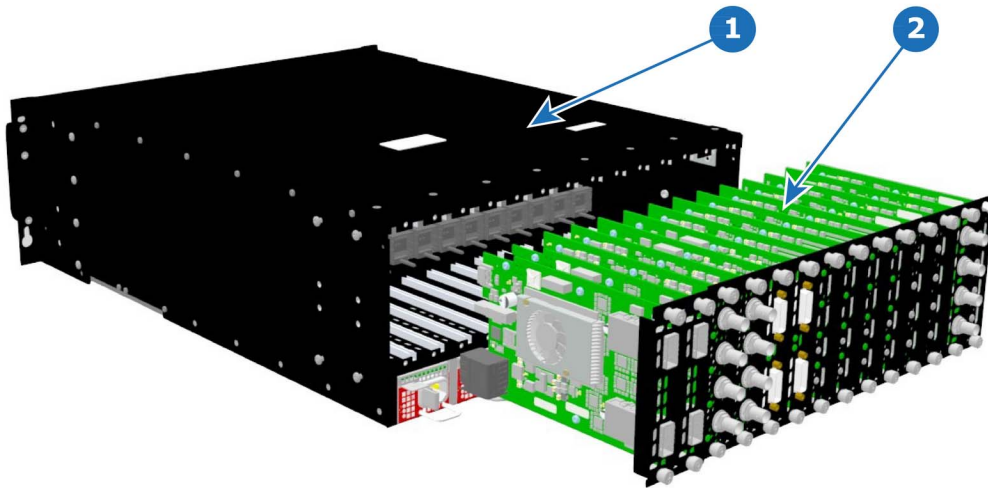

Image 14-4
 1 Chassis
 2 I/O and Link Cards

Concerned parts

R9004740	DVI Input
R9004741	SDI Output
R9004742	SDI Input
R9004743	HDMI Output
R9004744	DP/HDMI Input
R9004745	DVI Output (*)
R9004746	Link Card
R9004785	Tri-Combo Input
R9004786	Tri-Combo Output

(*) Not available in release 1)

Necessary tools

Phillips Screwdriver #2.

How to remove a card

1. Locate the card you wish to replace.
Note: There are 14 card slots. The first slot on the left is slot 1 and the last slot on the most right position is 14.
2. Loosen and unscrew the top and bottom thumbscrews that are holding the card to the chassis.
3. Gently pull the card out of its slot.
Tip: You may need to wobble it a little bit up or down to loosen it from the card guides as you are pulling out.

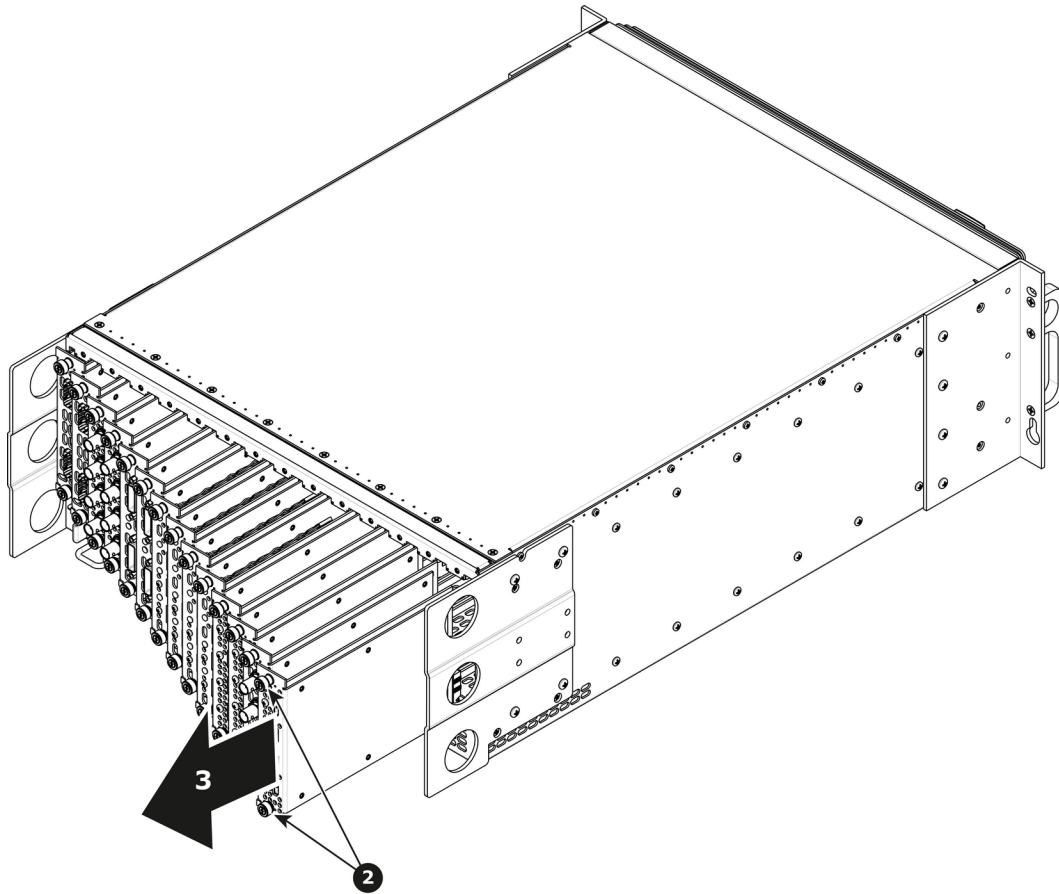

Image 14-5

How to install a card

To install a card follow the same procedure in the reverse order.



Apply a little pressure on the card until it is fully inserted in the back plane connector.

14.5 Rear I/O, VPU and Link card Heatsink Fan

Flow chart

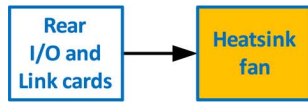

Image 14-6

Overview

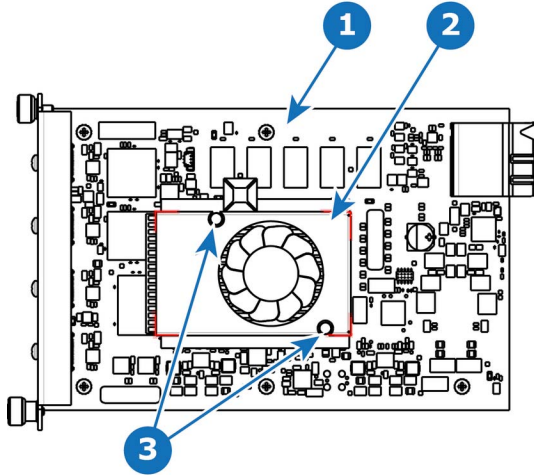

Image 14-7
 1 I/O board
 2 Heatsink Fan
 3 Pins

Concerned parts

R767263K	Heatsink Fan
----------	--------------

Necessary tools

- 1 x Phillips Screwdriver #2.
- Small fine nose pliers.

How to remove the Rear I/O, VPU and Link card Heatsink Fan

1. After you remove the card from the chassis, unplug the heatsink fan power wire from the PCB connector.
2. Locate the two pins that are located on opposite corners of the Heatsink and secure the fan on to the board.
3. Turn the board over and with small fine nose pliers while bringing together the two sides of the pin push it through the hole.
4. After both pins are pushed through the holes, you can remove the heatsink from the card.

How to install the Rear I/O, VPU and Link card Heatsink Fan

1. Remove the heatsink with the fan from the package.
2. Remove the plastic cover from the bottom of the fan to expose the adhesive material.
3. Align the holes in the board with the pins of the Heatsink.
4. Press firmly the heatsink to the devices below.
5. Plug the heatsink fan power wire to the PCB connector.

14.6 Front Cover Assembly

Flow chart

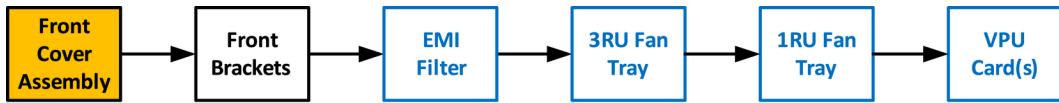

Image 14-8

Overview

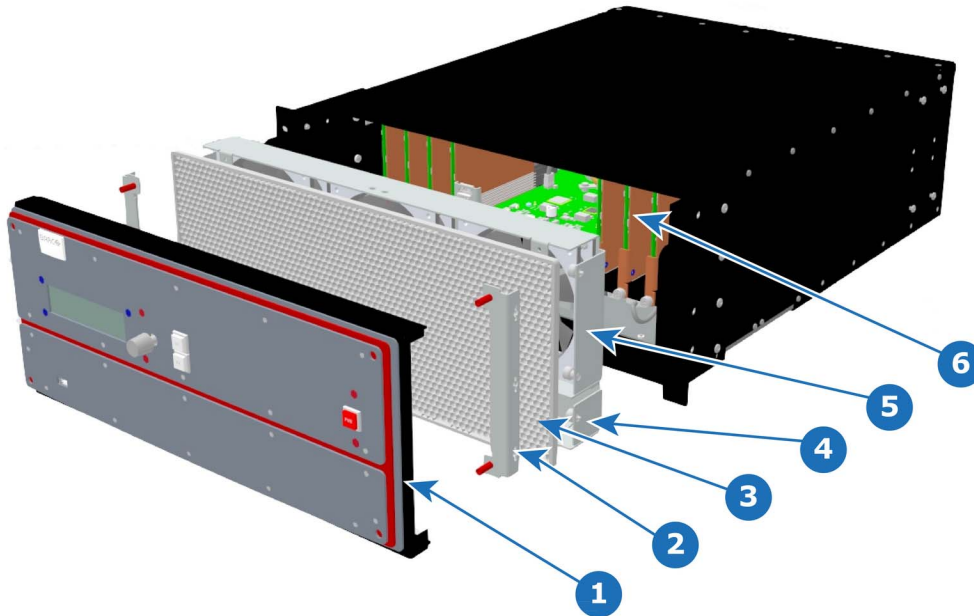

Image 14-9

- 1 Front Cover Assembly
- 2 Front Brackets
- 3 EMI Filter
- 4 1RU Fan Tray
- 5 3RU Fan Tray
- 6 VPU Cards



The EMI filter is no longer needed, and it can be removed. If the EMI filter is left in place, it requires servicing. See "E2 maintenance actions", page 374.

Necessary tools

1 x Screwdriver HEX 0.05" 7.05" (Provide by Barco in the original package).



Image 14-10

How to remove the Front Cover Assembly

1. Use the Hex screwdriver to remove the 4 screws (Hex 6-32x.25) that attach the front cover to the brackets located behind it.
Note: the standoffs go through the holes in sheet metal to properly align the front enclosure.

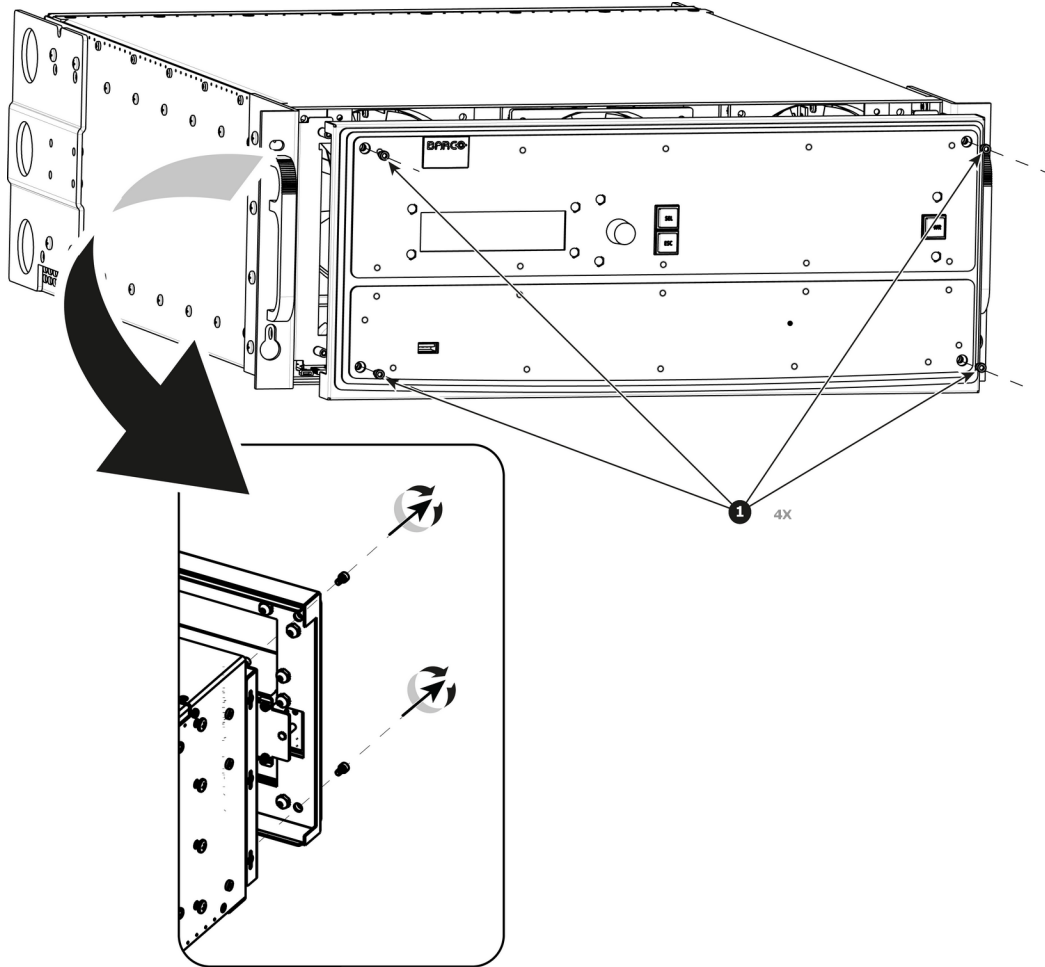

Image 14-11

2. Pull out the Front cover and lay it flat in front of the unit.

At this point there are still 3 cables connecting the Front cover to the unit.

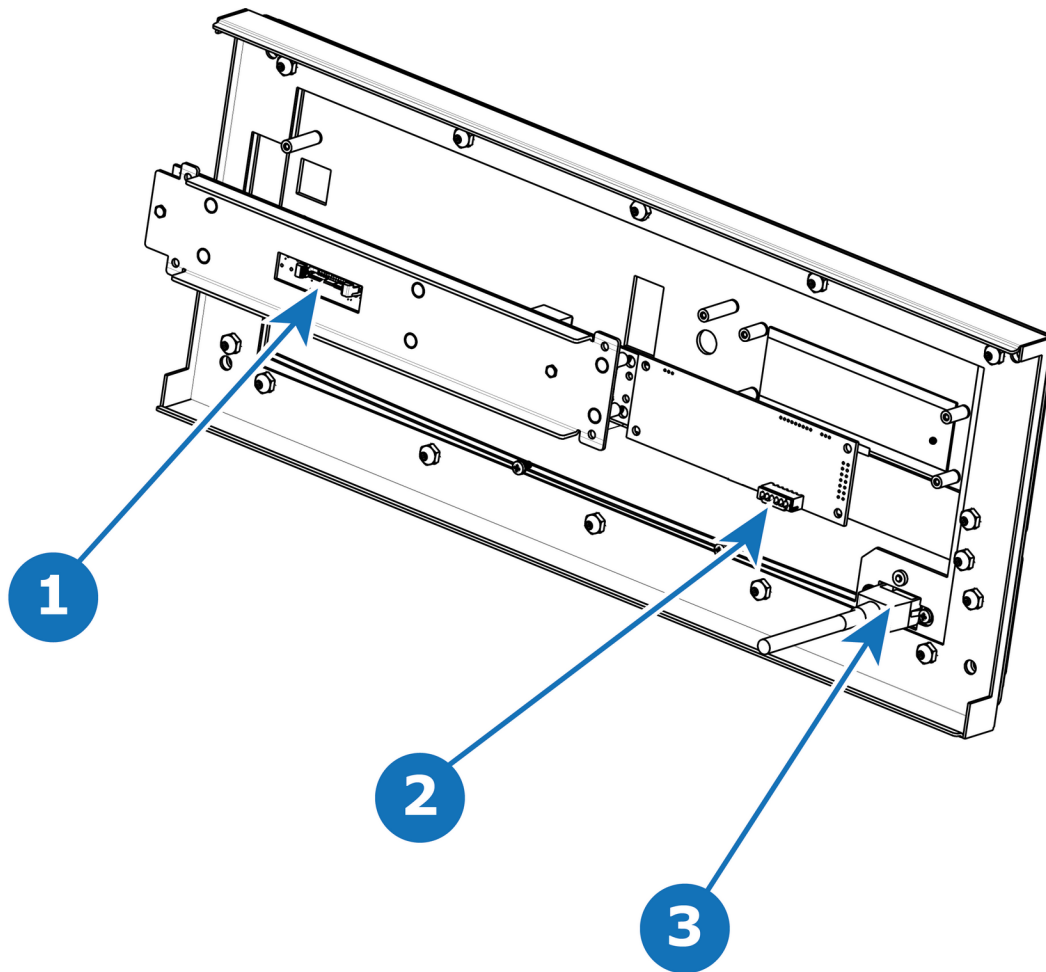

Image 14-12

- 1 Front Panel Connector
- 2 VFD Connector
- 3 USB Connector

3. Pull the latches away from connectors and gently pull the flat Front Panel away.
4. Remove cables as outlined in the related procedures (VFD, USB and Front Panel connectors).

How to install the Front Cover Assembly

To install the Front Cover Assembly follow the same procedure in the reverse order.

14.7 Front Brackets

Flow chart

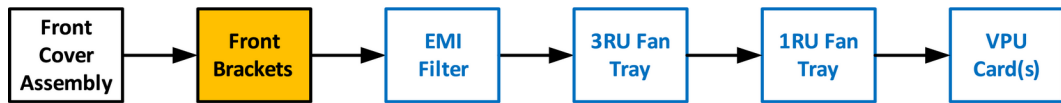

Image 14-13

Necessary tools

None.

How to remove the Front Brackets

1. Remove the two front brackets by lifting them up and then pulling them inwards and then out.

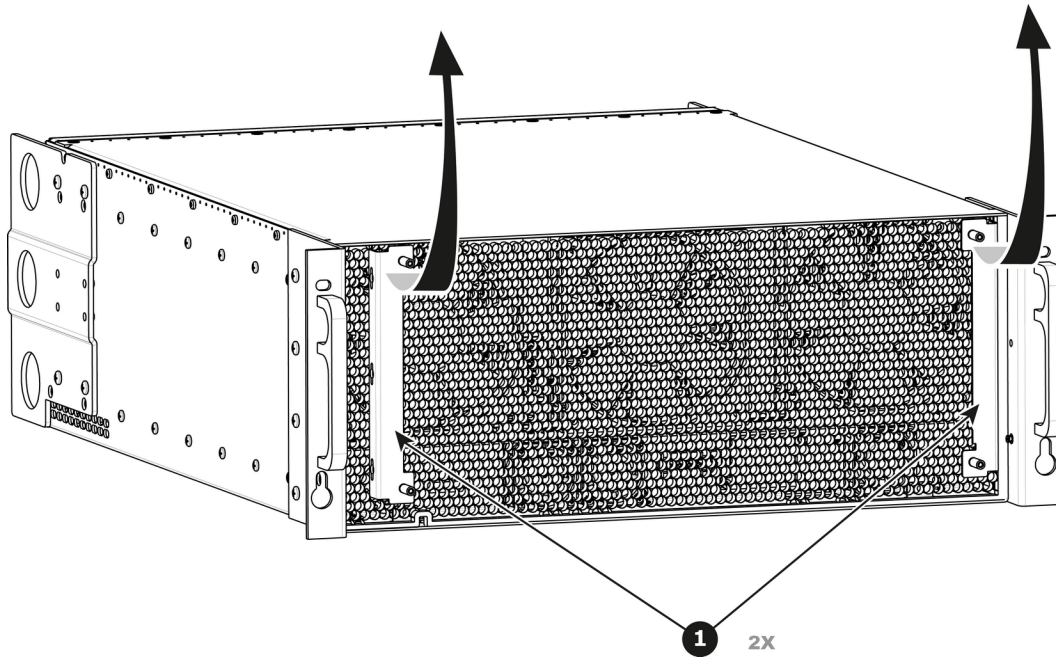

Image 14-14

How to install the Front Brackets

To install the front Brackets follow the same procedure in the reverse order.

14.8 3RU Fan Tray

Flow chart

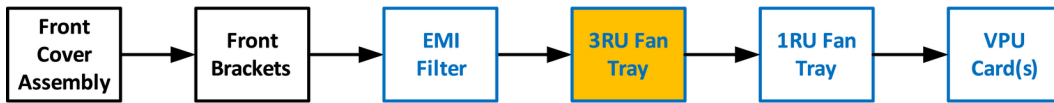

Image 14-15

Concerned parts

R767271K	3RU Fan Tray
----------	--------------

Necessary tools

1 x Phillips Screwdriver #2 (optional).

How to remove the 3RU Fan Tray

- Loosen and unscrew the 4 thumbscrews holding the 3RU fan tray to the chassis.
Note: You may need a screwdriver if the thumbscrews are very tight.
- Pull the tray out.
Note: You need to tilt the tray and maneuver it to go around the dimples located on the side of the chassis.

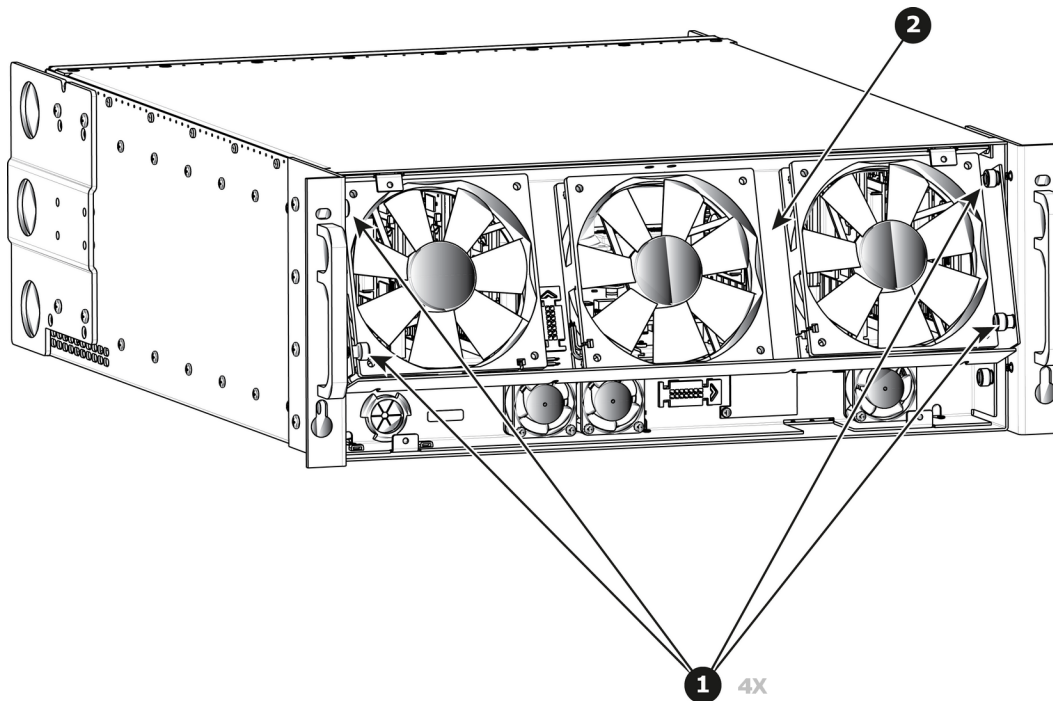

Image 14-16

How to install the 3RU Fan Tray

Follow the same procedure in the reverse order and in addition perform the following:

- Ensure that the bottom slots at the bottom of the tray align with the pins located on the bracket in the chassis.
- Make sure that the connector located at the back of the tray is aligned to the connector located on the bracket behind it.
- Push so that the two connectors mate.

14.9 1RU Fan Tray

Flow chart

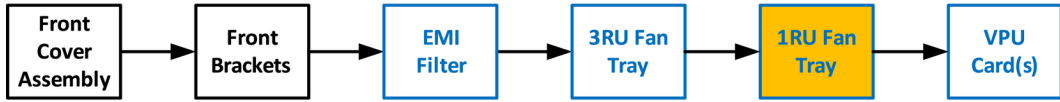

Image 14-17

Concerned parts

R767270K	1RU Fan Tray
----------	--------------

Necessary tools

1 x Phillips Screwdriver #2 (optional).

How to remove the 1RU Fan Tray

- Loosen and unscrew the 2 thumbscrews holding the 1RU fan tray to the chassis.
Note: You may need a screwdriver if the thumbscrews are very tight.

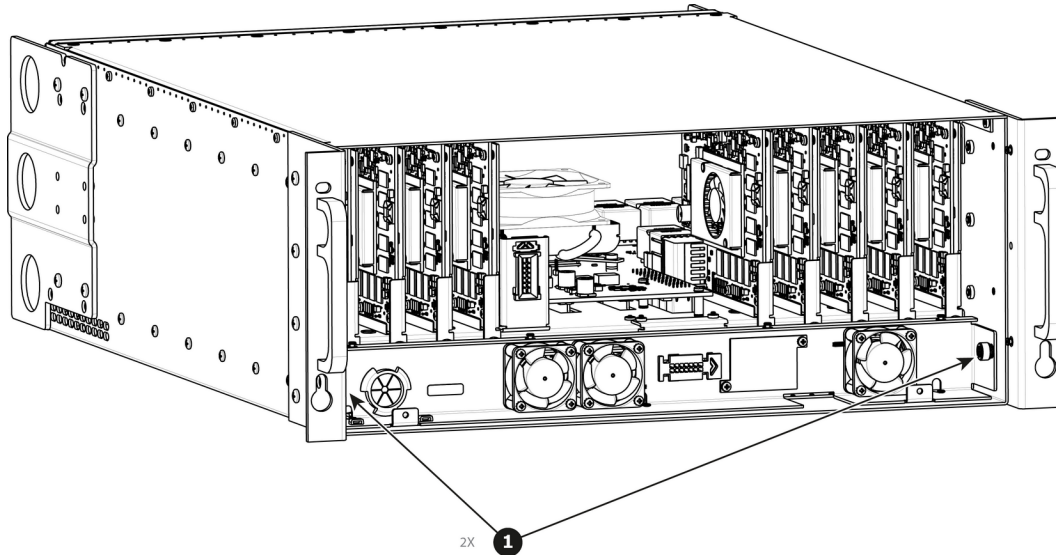

Image 14-18

- Pull the tray out.
Note: You might need to tilt the tray and maneuver it to go around the dimples located on the side of the chassis.

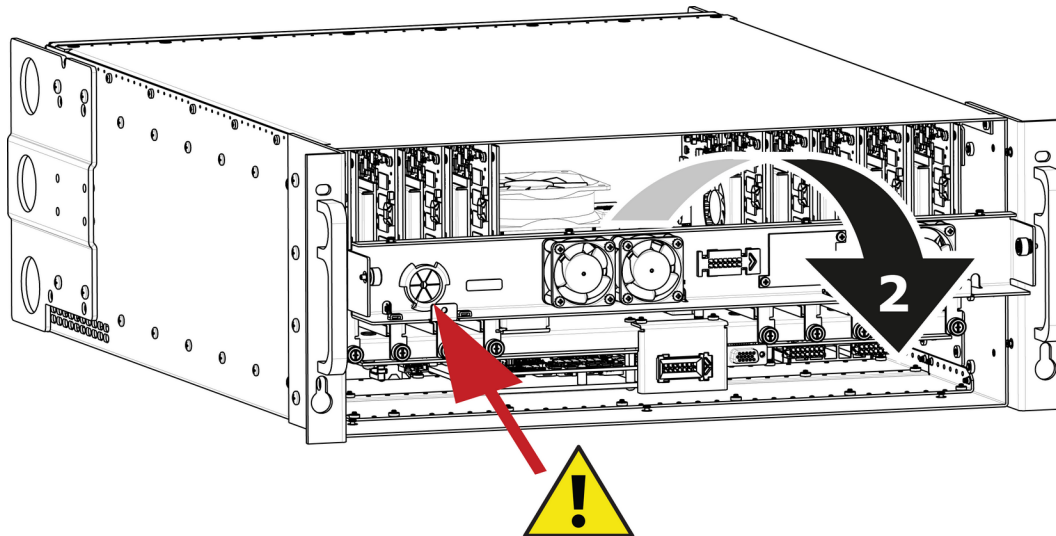

Image 14-19

Caution: Before you completely remove it from the unit carefully push the USB and Front panel cables through the grommet located on the left hand side.

How to install the 1RU Fan Tray

Follow the same procedure in the reverse order and in addition perform the following:

1. Pass the USB and VFD cable through the grommet.

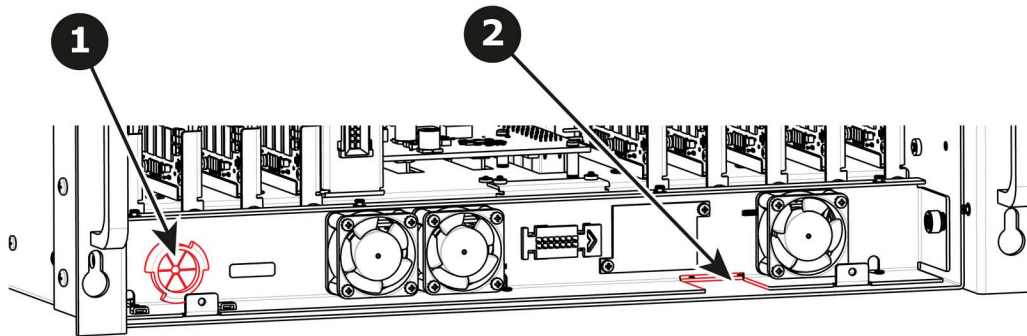

Image 14-20

2. Make sure that the front panel flat cable goes through the slot located on the right hand side.
3. Line up the connector behind the fan tray and the connector on the bracket behind it and push so the two connectors mate.

14.10 VPU Card(s)

Flow chart

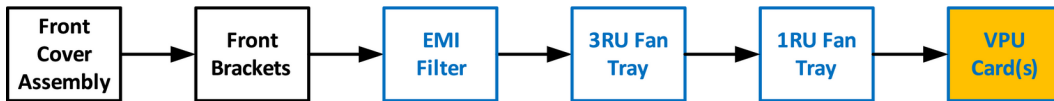

Image 14-21

Overview

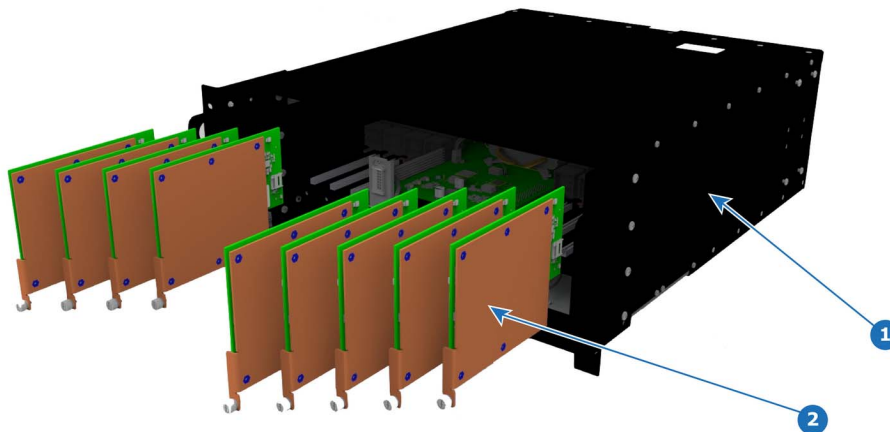

Image 14-22
 1 Chassis
 2 VPU cards

Concerned parts

R9004747	VPU Card
----------	----------

Necessary tools

1 x Phillips Screwdriver #2 (optional).

How to remove a VPU Card

1. Locate the VPU you need to replace.
Note: There are 9 VPU slots. The first slot on the left is slot 15 and the last slot on the most right position is 23.
2. Loosen and unscrew the thumbscrew that is holding VPU card to the chassis.
3. Pull the VPU out of its slot.

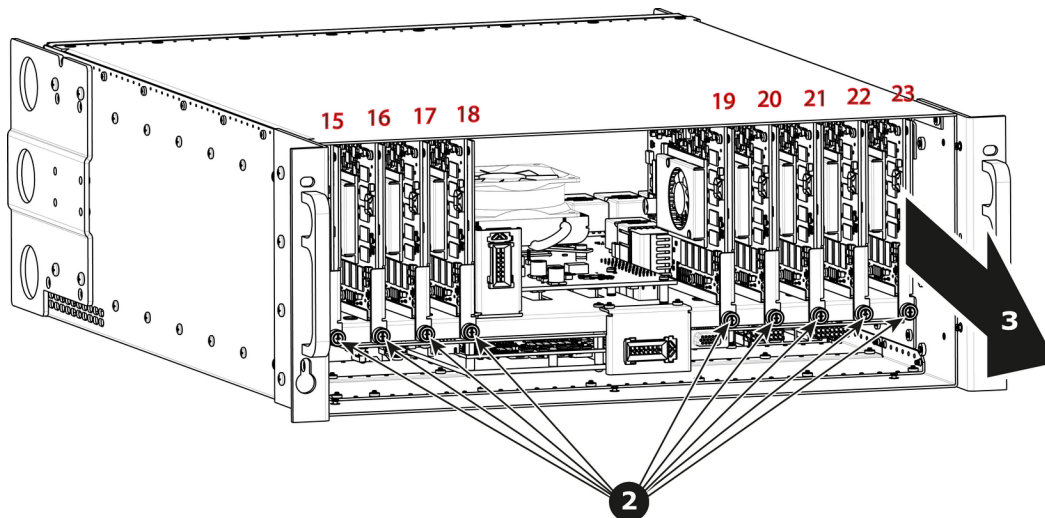

Image 14-23

How to install a VPU Card

To install a VPU Card follow the same procedure in the reverse order.

14.11 Front Panel Knob

Flow chart

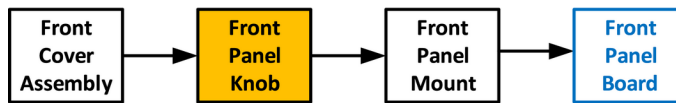

Image 14-24



Before you proceed removing the Front panel knob you need to remove the Front Cover Assembly as outlined in the related procedure.

Necessary tools

- Knob removal tool provided by Barco



Image 14-25

- Flat head screwdriver or a tool with a sharp edge

How to remove the Front Panel Knob

1. Remove the knob cover with a flat screw driver or a sharp object to expose the inside of the knob.

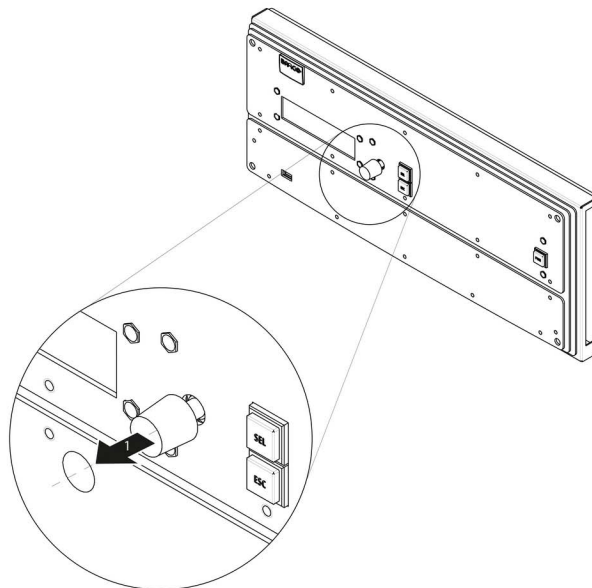

Image 14-26

2. Use the knob removal tool provided by Barco to take out the knob. Align the notches on the tool with the grooves in the knob as indicated below.

Note: If the tool is not available use fine point needle nose pliers to squeeze at knob between the two grooves while pulling it out.



Image 14-27

How to install the Front Panel Knob

To install the Front Panel Knob follow the same procedure in the reverse order.

14.12 Front Panel Mount

Flow chart

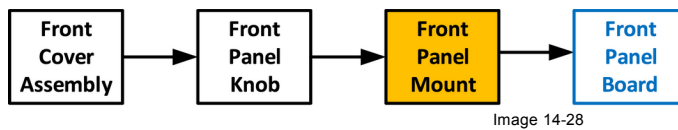

Necessary tools

1 x Phillips Screwdriver #2

How to remove the Front Panel Mount

1. Turn the Front Cover over and remove the four screws (4-40X.25) that secure the control panel mount to the front panel.

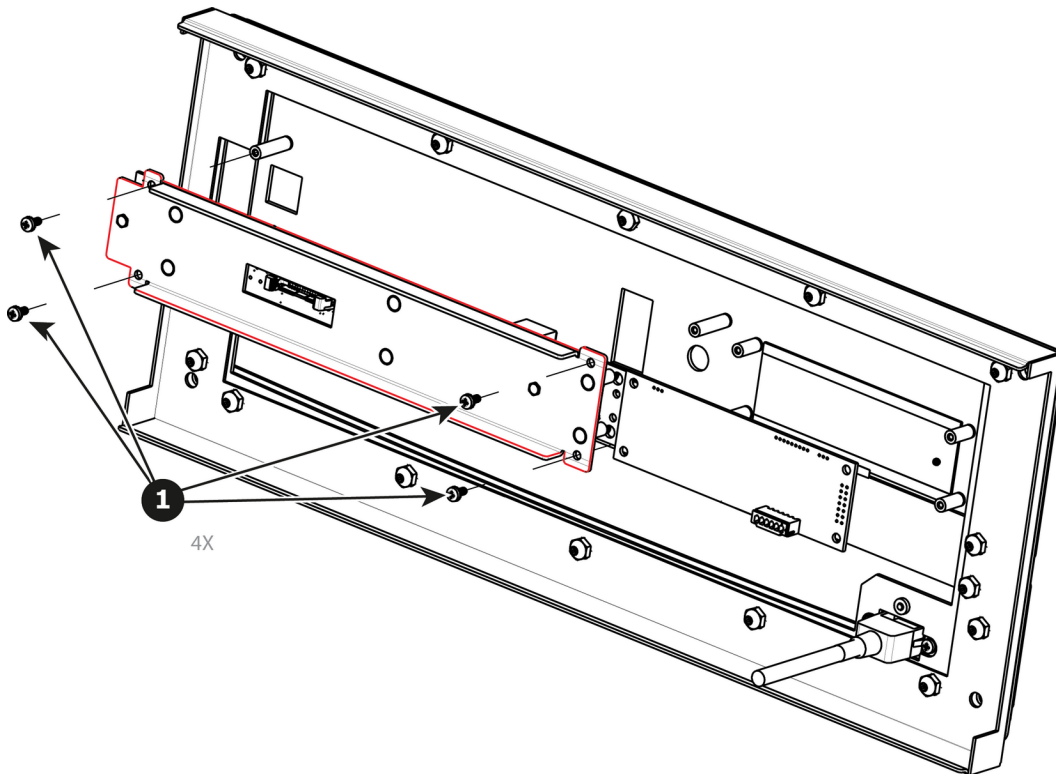

Image 14-29

How to install the Front Panel Mount

To install the Front Panel Mount follow the same procedure in the reverse order.

14.13 Front Panel Board

Flow chart

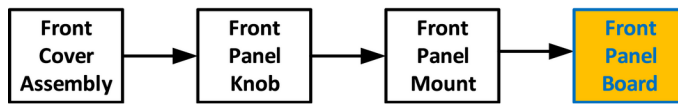

Image 14-30

Concerned parts

R767260K	Front Panel Board
----------	-------------------

Necessary tools

1 x Phillips Screwdriver #2

How to remove the Front Panel Board

1. Remove the two screws (4-40X.25) that secure the PCB to the front mount.

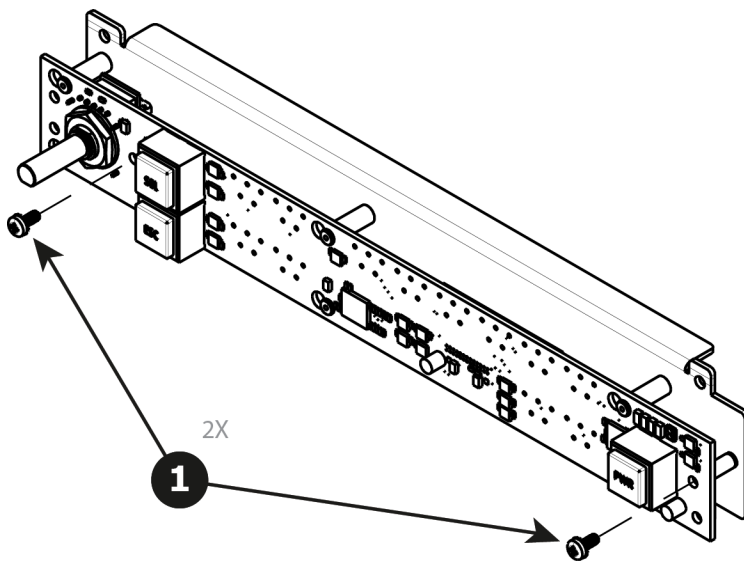

Image 14-31

2. Move the PCB to the right and then out to release it from the mount.

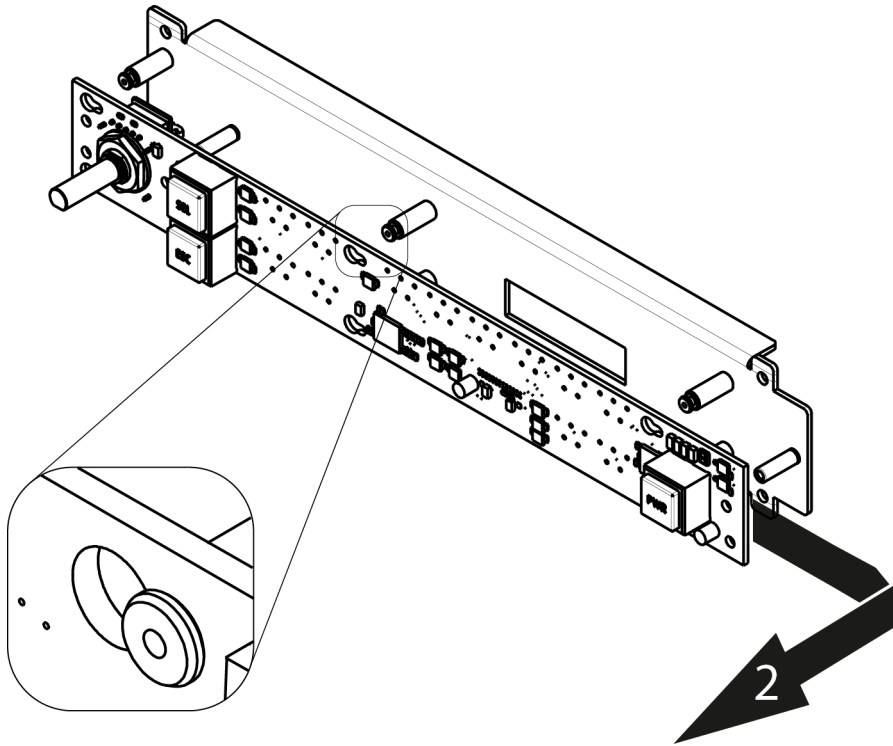

Image 14-32

How to install the Front Panel Board

To install the Front Panel Board follow the same procedure in the reverse order.

14.14 VFD Display Assembly

Flow chart



Image 14-33



Before you proceed removing the VFD Display mount you need to remove the Front Cover Assembly as outlined in the related procedure

Concerned parts

R767241K	VFD Display Assembly
----------	----------------------

Necessary tools

1 x Phillips Screwdriver #2

How to remove the VFD Display Assembly

1. Turn the Front Cover over and remove the four screws (4-40X.25) that secure the VFD display assembly to the front panel mount.

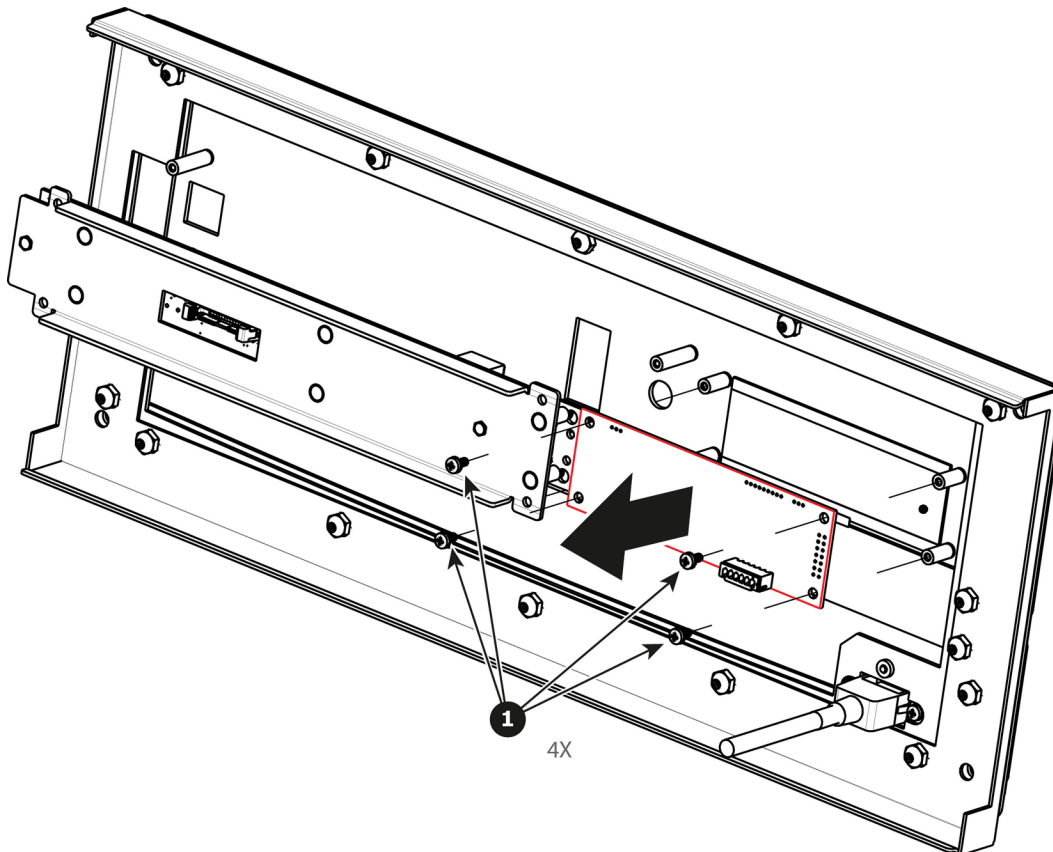

Image 14-34

How to install the VFD Display Assembly

To install the VFD Display Assembly follow the same procedure in the reverse order.

14.15 VFD Display Filter

Flow chart



Image 14-35

Concerned parts

R767246K	VFD Display Filter
----------	--------------------

Necessary tools

None.

How to remove the VFD Display Filter

1. From the front of the unit push hard on the filter until it detaches from the unit.

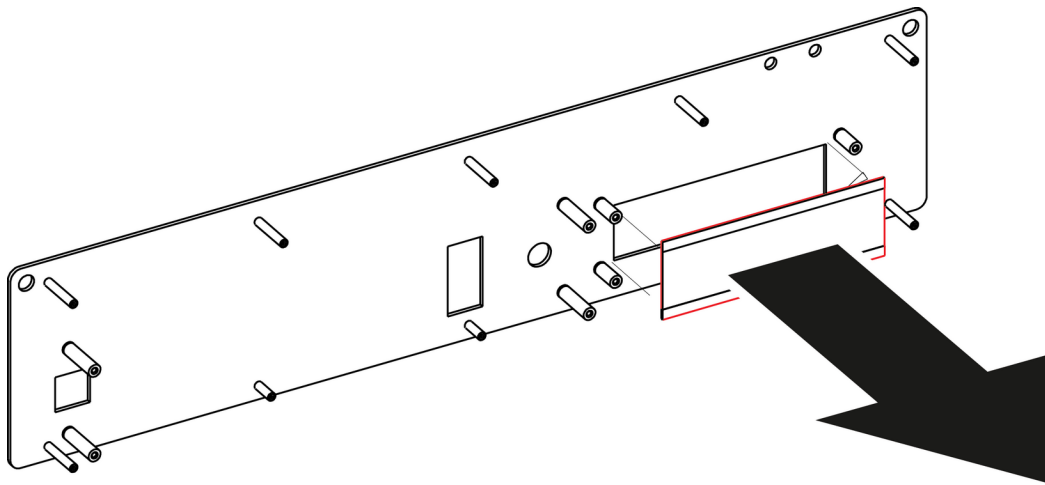

Image 14-36

2. Use alcohol to clean the adhesive residue that held the filter to the metal plate.

How to install the VFD Display Filter

1. Remove the protective film from the front of the filter and release the liner from the tape.
2. Press firmly the filter into the metal plate.

14.16 Bottom Panel

Necessary tools

1 x Phillips Screwdriver #2

How to remove the Bottom Panel

1. Turn the unit over to remove the bottom panel. The bottom panel is composed of two pieces.
2. Remove the 4 black round-head screws (4-40x1/4) that attach the panels to the side of the unit.
3. Remove the 6 screws that hold the two sides together.
4. Remove the rest of the screws from the perimeter of the panel as shown below.
5. Push on the edge of the piece that is in the middle of the chassis until it's loosened and release from the unit. Carefully remove this piece from the unit.
6. Remove the other piece.

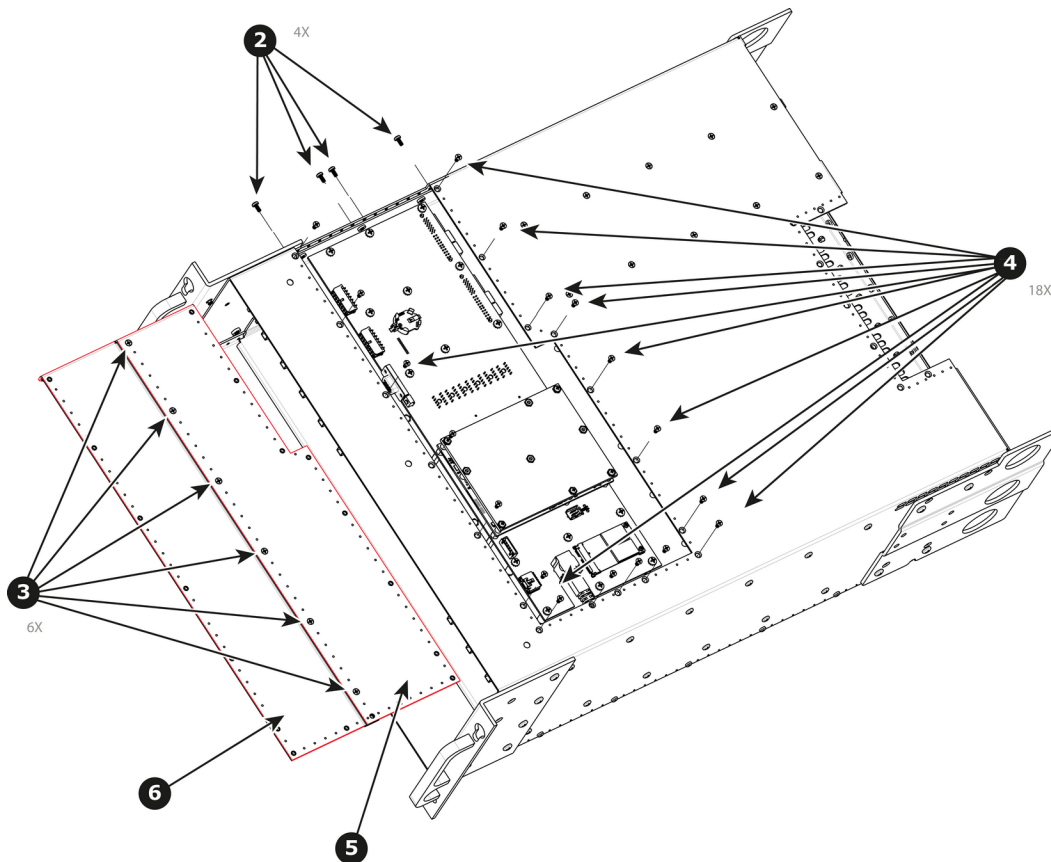

Image 14-37

How to install the Bottom Panel

To install the Bottom Panel follow the same procedure in the reverse order.

14.17 Solid-State Memory

Flow chart

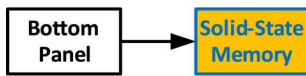

Image 14-38



Before you proceed removing the Solid State Memory you need to remove the Bottom Panel as outlined in the related procedure.



The solid-state memory can also be replaced after the System Power board is removed from the unit.

Overview

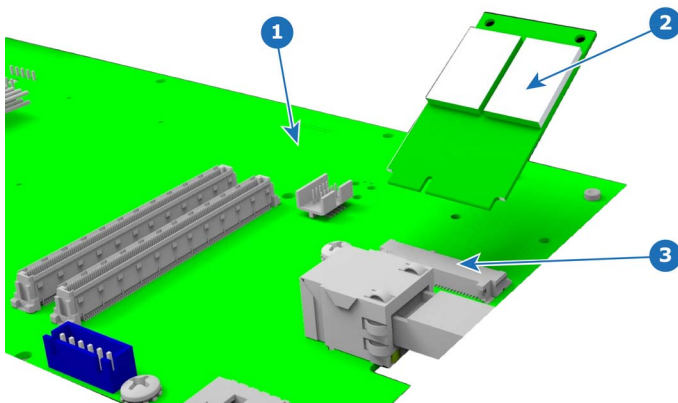

Image 14-39

- 1 System Power board
- 2 Solid State Memory card
- 3 Socket

Concerned parts

R767275K	Solid State Memory
----------	--------------------

Necessary tools

- 1 x Phillips Screwdriver #2

How to remove the Solid State Memory

1. Remove the 2 screws that hold the memory card.
2. Carefully remove the memory card from the socket.

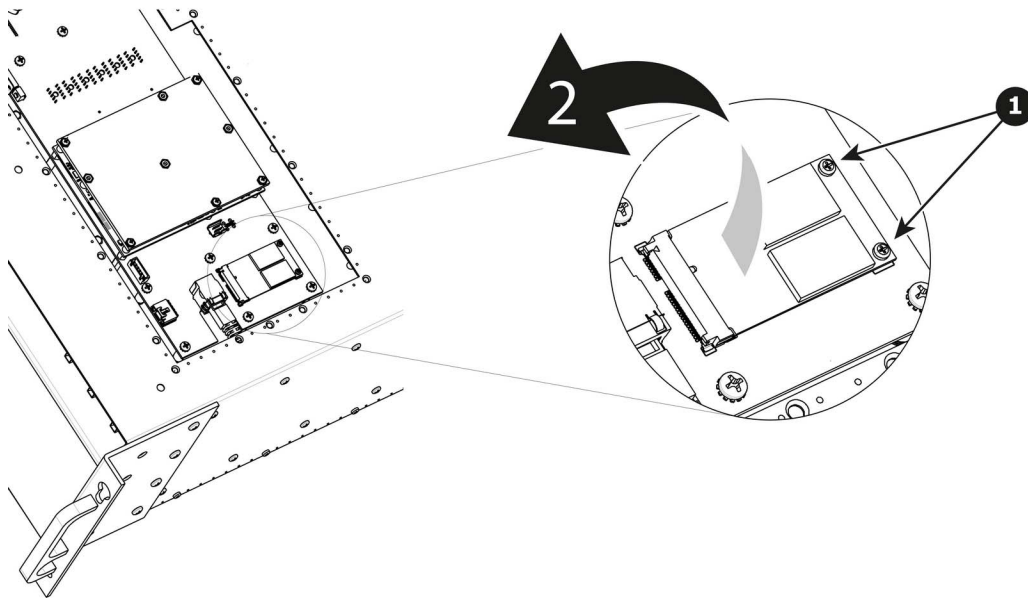

Image 14-40

How to install the Solid State Memory

To install the Solid State Memory follow the same procedure in the reverse order.

14.18 System Battery

Flow chart

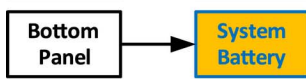

Image 14-41



Before you proceed removing the System Battery you need to remove the Bottom Panel as outlined in the related procedure.



The System Battery can also be replaced after the System Power board is removed from the unit.

Concerned parts

V327007	Battery
---------	---------

Necessary tools

None.

How to remove the System battery

1. Carefully remove the battery from its socket.

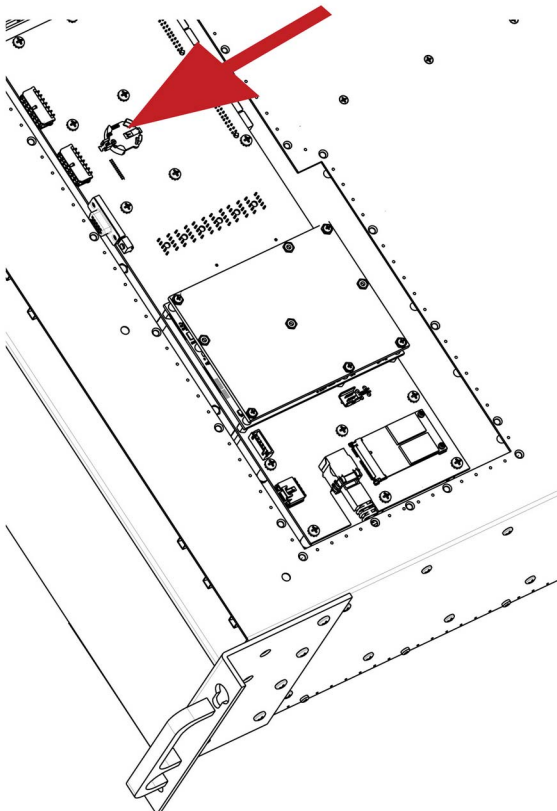

Image 14-42

How to install the System battery

To install the System battery follow the same procedure in the reverse order.



When a new battery is installed, the user need to place a sticker on the inside of the metal plate (Bottom Panel) that indicates when the battery was last replaced. The absence of sticker means the battery has never been replaced. In this case the S/N sticker can be used for the reference date.

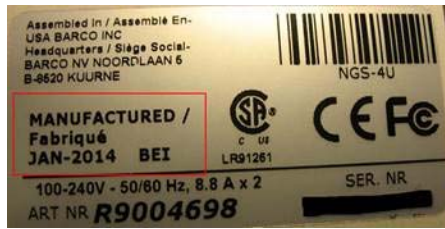

Image 14-43

14.19 CPU Module

Flow chart

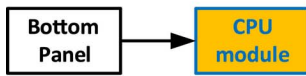

Image 14-44



Before you proceed removing the CPU module you need to remove the Bottom Panel as outlined in the related procedure.

Overview

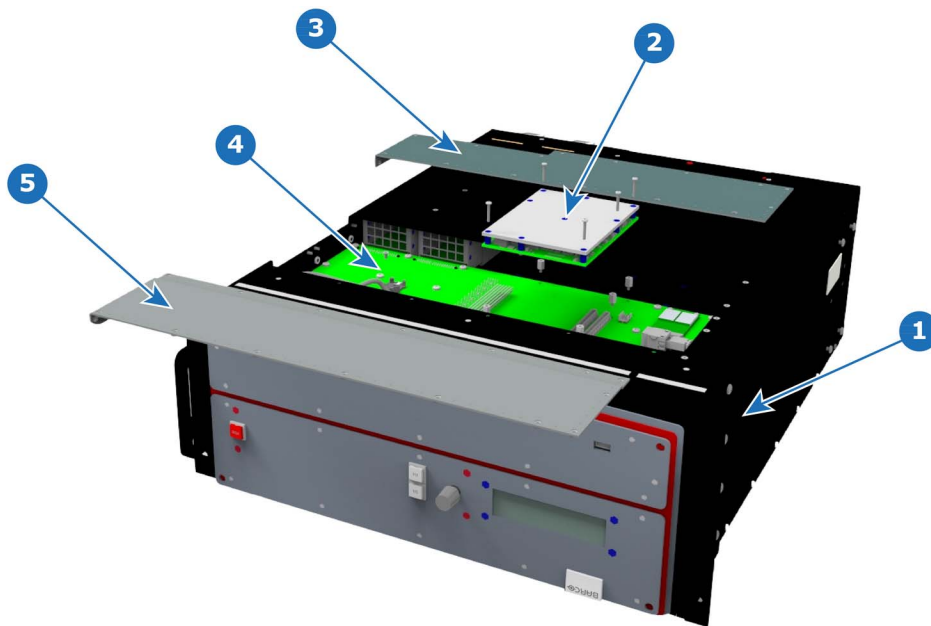

Image 14-45

- 1 Chassis
- 2 CPU Module
- 3 Bottom Panel Part 1
- 4 System Card.
- 5 Bottom Panel Part 2

Concerned parts

R767264K	CPU module
----------	------------

Necessary tools

1 x Phillips Screwdriver #2

How to remove the CPU module

1. Remove the five screws that attach CPU module to the system card.
2. Carefully remove the CPU module by lifting it up.

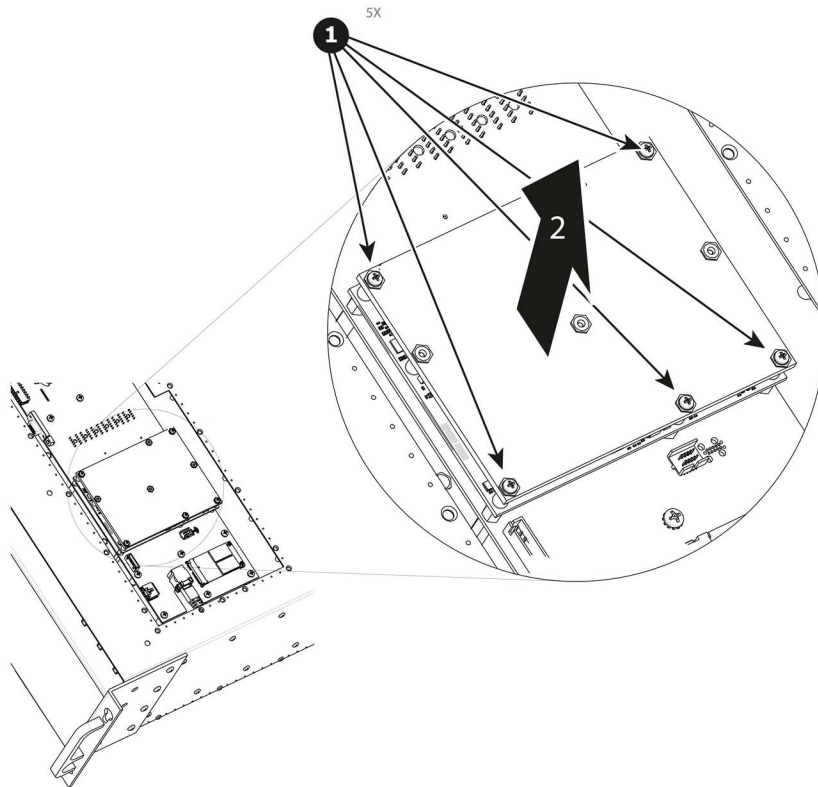

Image 14-46

How to install the CPU module

To install the CPU module follow the same procedure in the reverse order.

14.20 Power Supply

Concerned parts

R767267K	Power Supply
----------	--------------

Necessary tools

None.

How remove Power Supply

1. Push the latch towards the right.

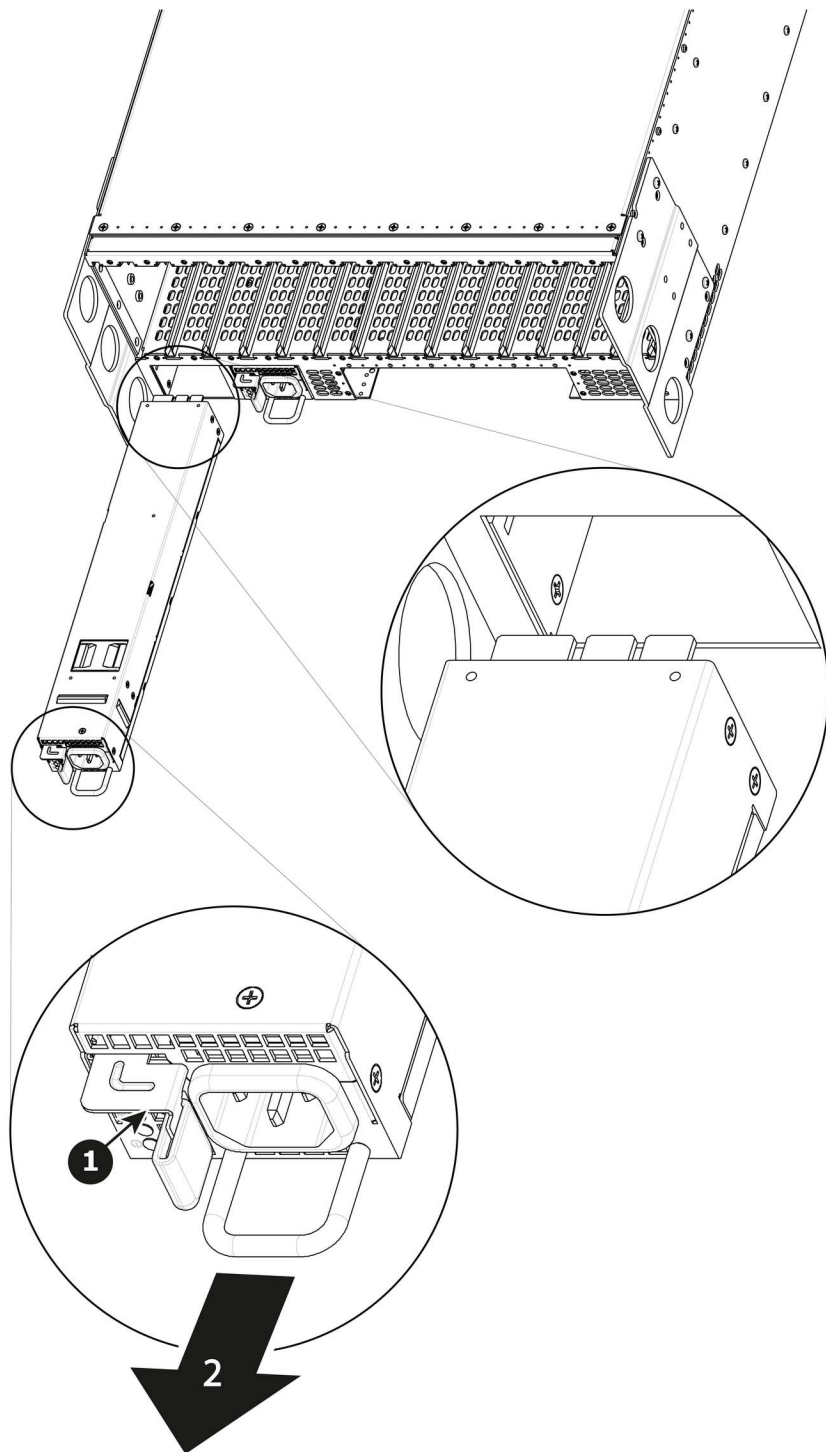

Image 14-47

2. Pull the Power supply out of its slot by pulling on the handle.

How to install Power Supply

1. Insert the Power Supply into the slot.
Note: *The card edge should be at the top of the power supply as shown in the drawing.*
2. Push the power supply completely inside the slot. Apply a little pressure by using the handle until the power supply is fully inserted.

14.21 System-Power Board

Flow chart

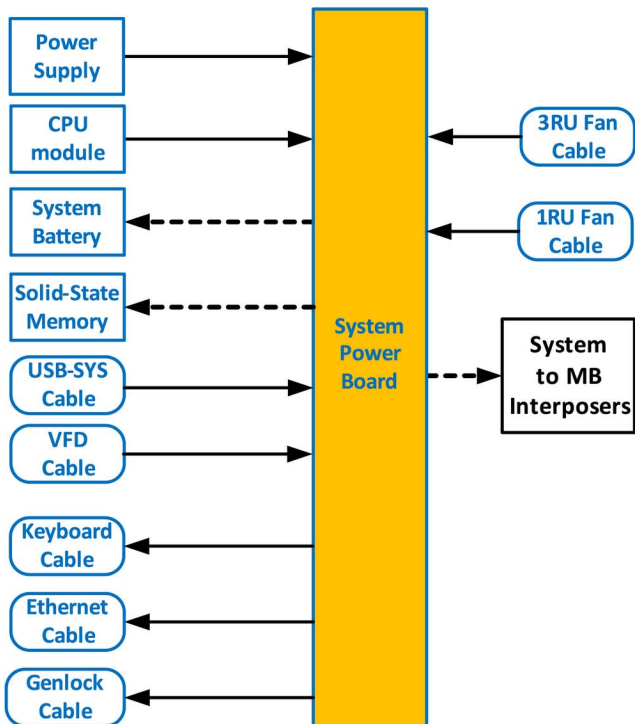

Image 14-48



Before you proceed removing the System-Power board you need to remove the Power Supplies, Bottom Panel and the CPU board. Follow the instructions provided in these sections.

Overview

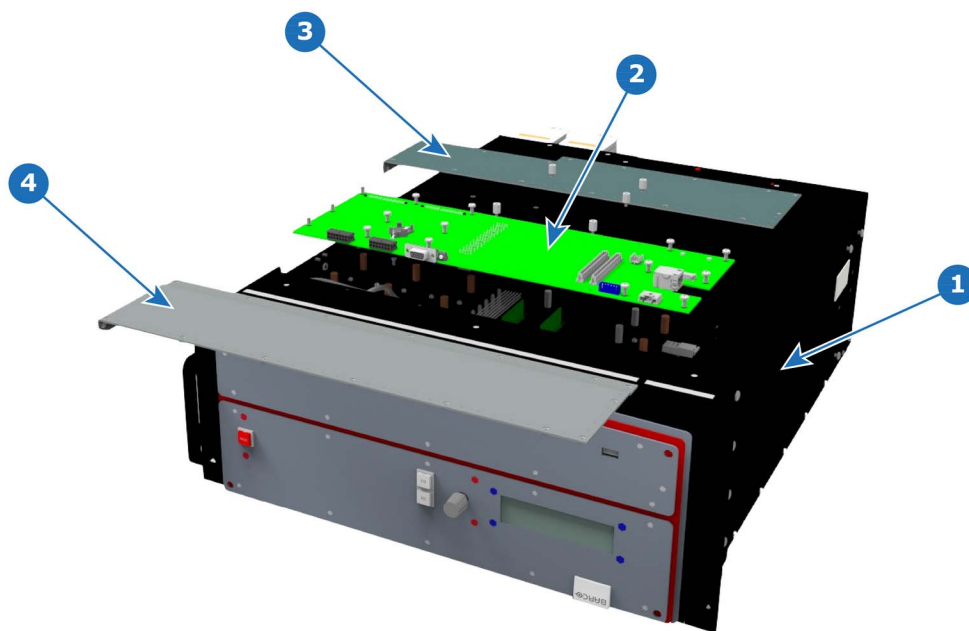

Image 14-49
 1 Chassis
 2 System-Power Board
 3 Bottom Panel part 1

4 Bottom Panel part 2

Concerned parts

R767261K	System-Power Board
----------	--------------------

Necessary tools

- 1 x Phillips Screwdriver #2
- Hex Screwdriver

How to remove the System-Power board

1. Unplug the USB, VFD, 3RU and 1RU cables that are plugged on the top side of the board and are visible when the bottom panel is removed. Refer to the drawing below (top side) to locate the cables.
2. With the Hex Screwdriver, remove the 5 standoffs (m 2,5 H6 Stainless Steel) which attach the CPU module to the motherboard.

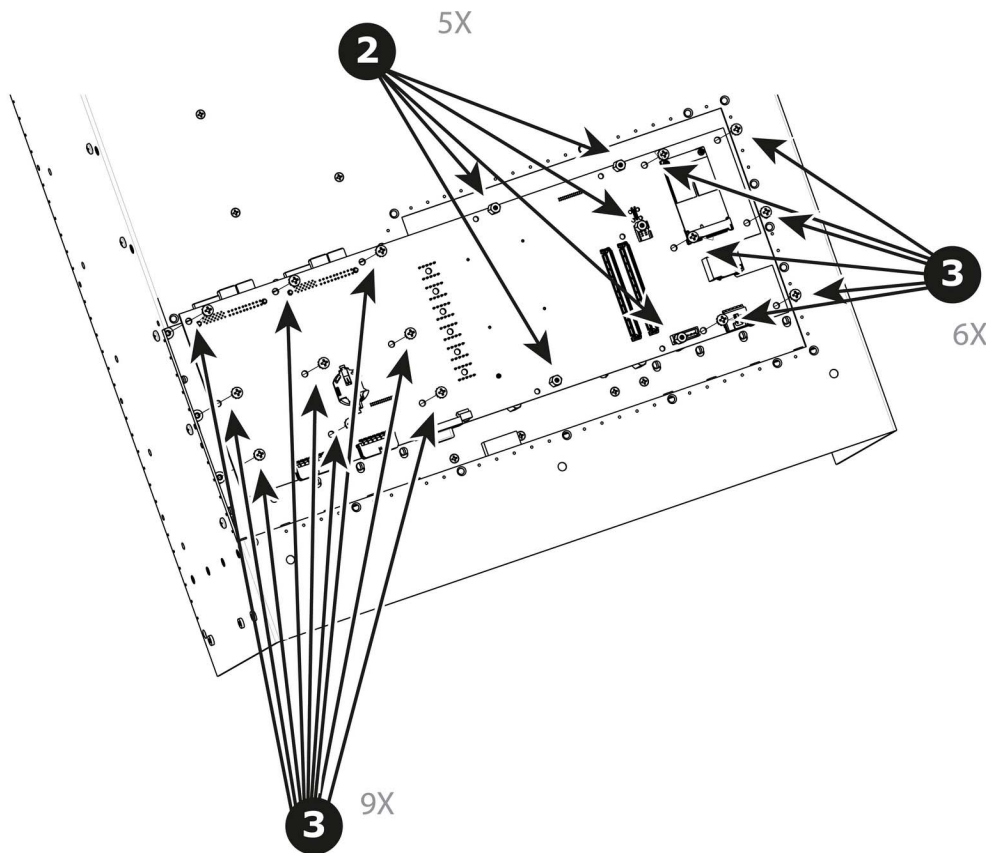

Image 14-50

3. Remove the 15 screws (6-32x.31 Stainless Steel) that attach the System Power Board to the Mother board.
4. Carefully lift the board up and remove the card from the System. Don't pull the board too far because there are still 3 cables attached to the card.
Note: *Interposer card(s) may come out. In this case, re-install the boards into the motherboard slots unit.*
5. Turn the board over and unplug the Genlock, Ethernet cable and Front panel keyboard cable. Refer to the drawing below (Bottom side) to locate the cables.



After the system card is removed, you can also replace the System battery or the Solid-State memory. These items can be serviced without removing the System-Power board as described in other sections of this chapter.

How to install the System-Power Board

To install the System-Power Board follow the same procedure in the reverse order.

Top side

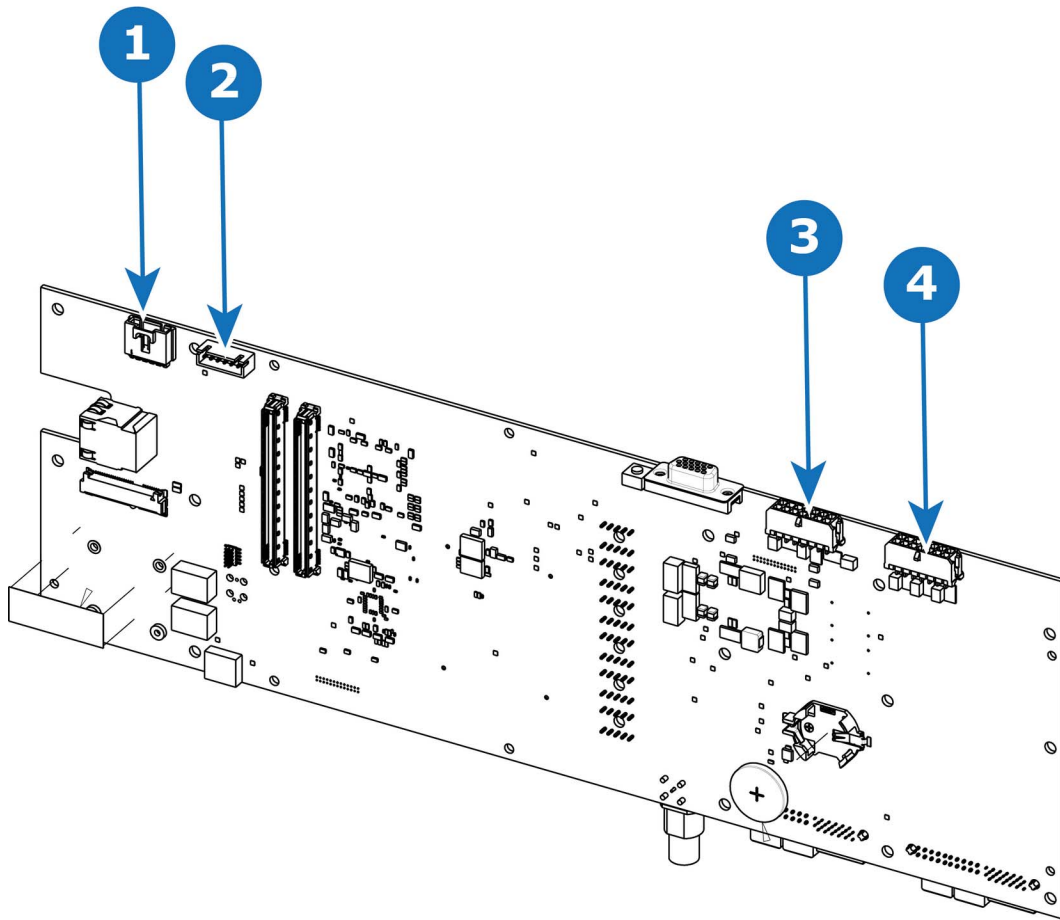

Image 14-51

1	USB connector	3	3RU connector
2	VFD connector	4	1RU connector

Bottom side

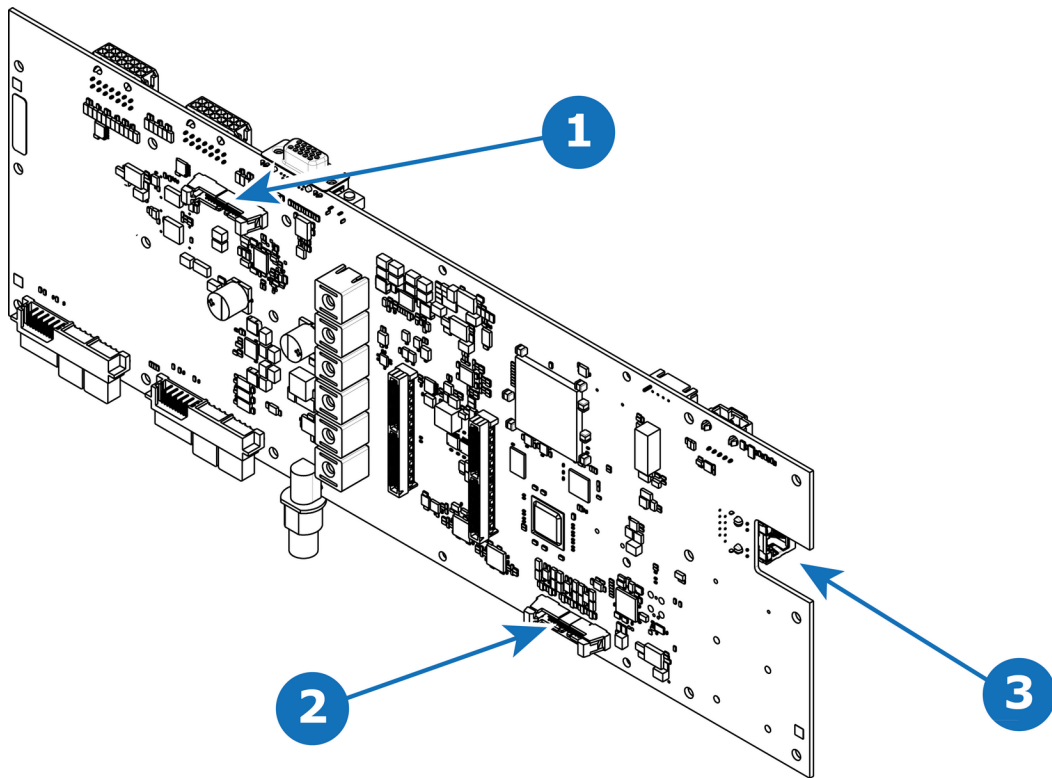

Image 14-52

1	Keyboard connector	3	Ethernet connector
2	Genlock connector		

14.22 Genlock Assembly

Flow chart



Image 14-53

Overview

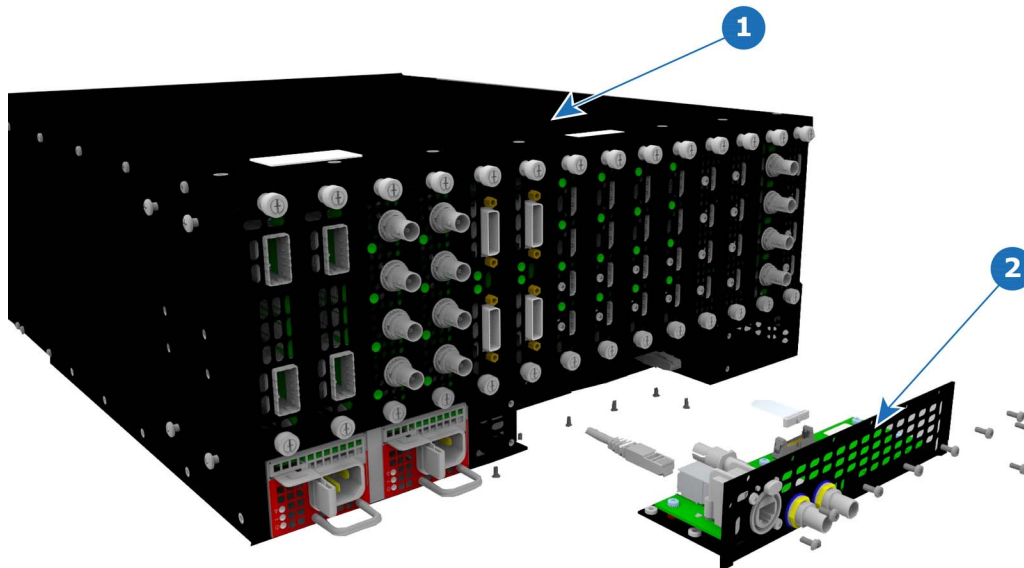

Image 14-54
 1 Chassis
 2 Genlock Assembly

Concerned parts

R9004748	Genlock Assembly
----------	------------------

Necessary tools

1 x Phillips Screwdriver #2

How to remove the Genlock Assembly

1. Remove the seven flat head screws (4-40 X .25) that attach the Genlock assembly to the rear side of the chassis.
2. Remove the ten pan head screws (4-40 X .25) that attach the Genlock assembly to the rear of the chassis.

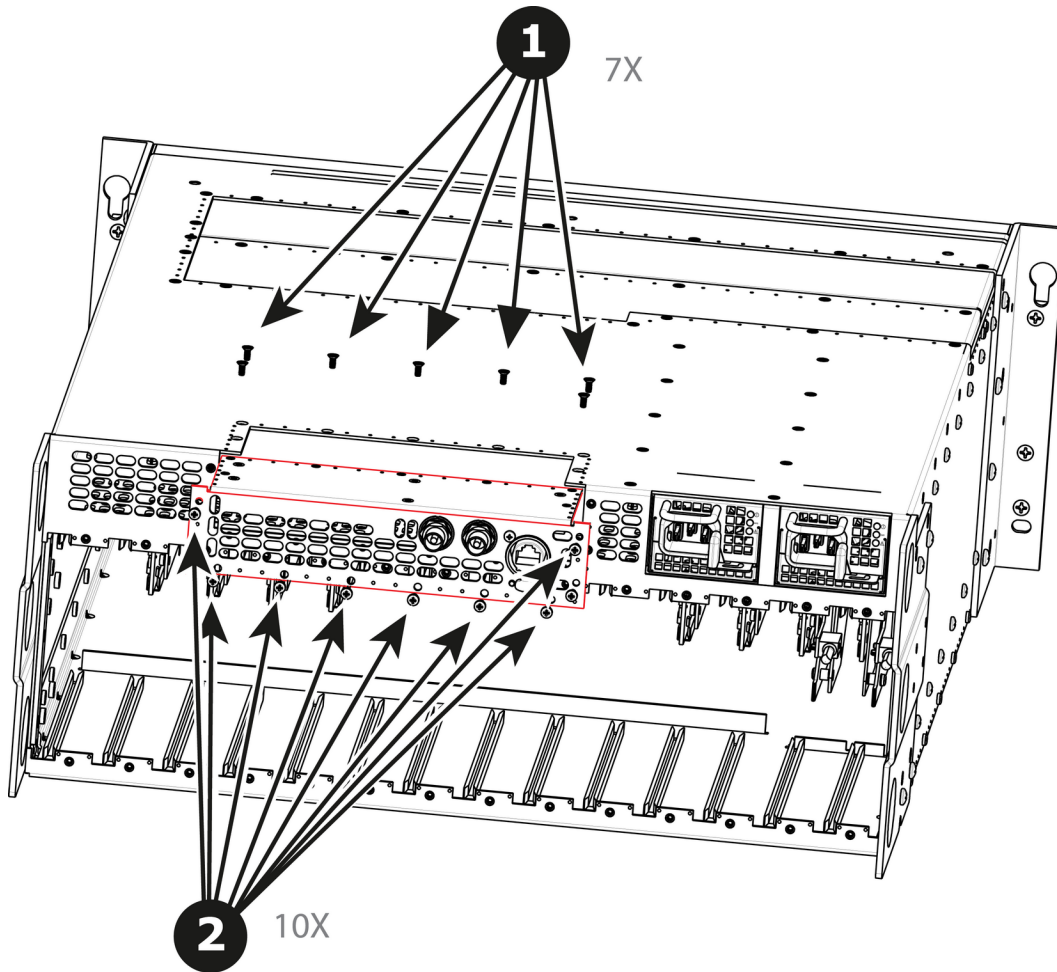

Image 14-55

3. Gently pull the Genlock assembly away from the unit . Don't pull the assembly too far back because there are still 2 cables attached.

Note: At this point there are still 2 cables connecting the Genlock Assembly to the unit.

4. Unlatch the VFD ribbon cable from the connector and pull it up and away from the Genlock board.

Note: This cable connects the Genlock board to the System-Power board.

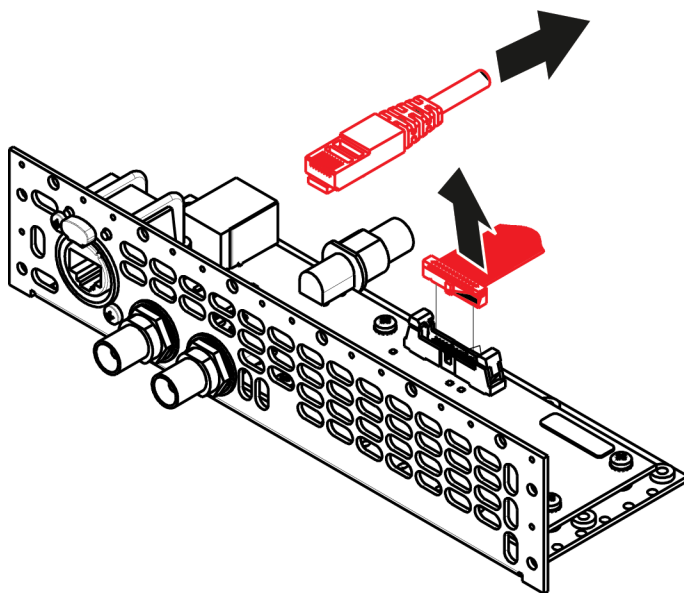

Image 14-56

5. Unlatch the Ethernet cable from the connector and pull back and away from the Genlock board.

Note: This cable connects the Genlock board to the System-Power board.

How to install the Genlock Assembly

To install the Genlock Assembly follow the same procedure in the reverse order.

14.23 USB Cable

Flow chart

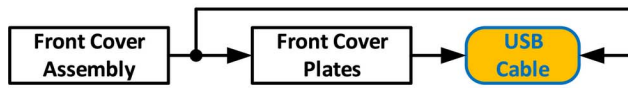

Image 14-57



The USB cable is connected to the USB extension cable (the cable that is connected to the System-Power board). This procedure provides instructions how to disconnect it from both sides of the cable.

Concerned parts

R767269K	Cable Kit Set
----------	---------------

Necessary tools

- 1 x Phillips Screwdriver #2
- Hex Screwdriver
- Nut socket.

How to remove the USB cable

1. Completely detach and pull the Front Cover assembly away from the unit (refer to the related procedure).
2. Disconnect the USB cable from the USB Extension cable (the other side of the cable is connected to the System-Power board).
3. Disconnect the VFD and Front Keyboard Panel cables from the VFD assembly and Front panel boards.
4. Place the Front panel enclosure face down on a flat area.
5. Use the nut socket to remove the 16 nuts (6-32) that attach the first plate to the assembly.
6. Remove and put aside the 16 spacers situated under the plate you just removed.

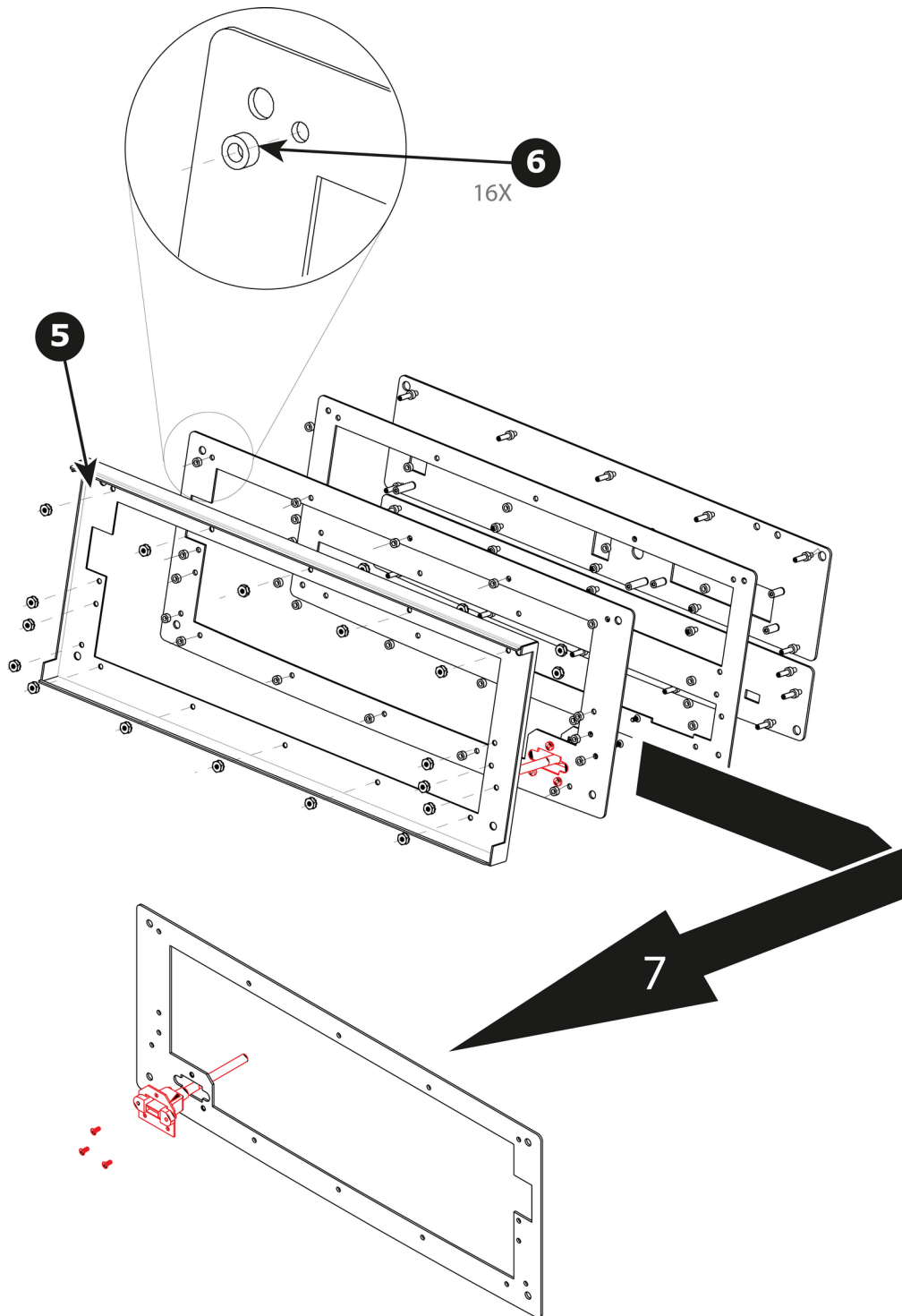

Image 14-58

7. Remove the plate that has been exposed after the nuts are removed.
8. Remove the three screws that hold the USB cable into the metal plate.

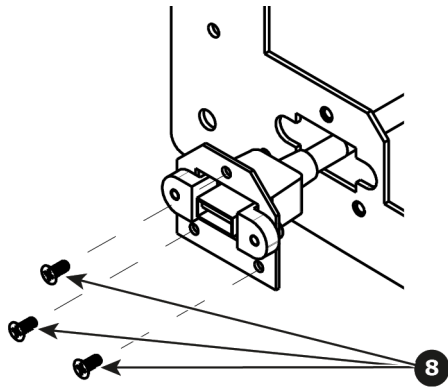

Image 14-59

9. Remove the USB cable.

How to install the USB cable

To install the USB cable follow the same procedure in the reverse order.

14.24 USB Extension Cable

Flow chart



Image 14-60



The USB Extension cable connects the USB cable to the System Power board. This procedure provides instructions on how to disconnect the cable on both sides.

Concerned parts

R767269K	Cable Kit Set
----------	---------------

Necessary tools

1 x Phillips Screwdriver #2

How to remove the USB Extension cable

1. Partially remove the front panel assembly and pull it away to expose the cables behind it (refer to the related procedure).
2. Disconnect the USB Extension cable from the USB cable.
3. Gently push the cable through the grommet located in the 1RU tray.

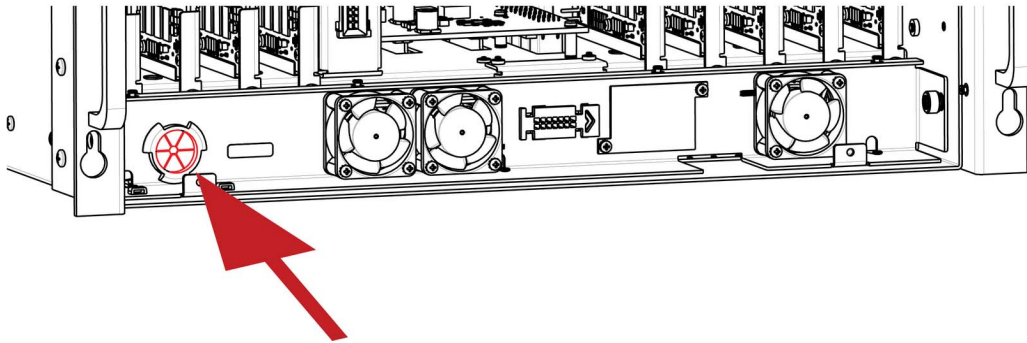

Image 14-61

4. Turn the unit upside down and remove the bottom panel (Follow the instructions provided in the bottom panel removal section).
5. Locate the USB Extension cable that is plugged on the System-Power board.

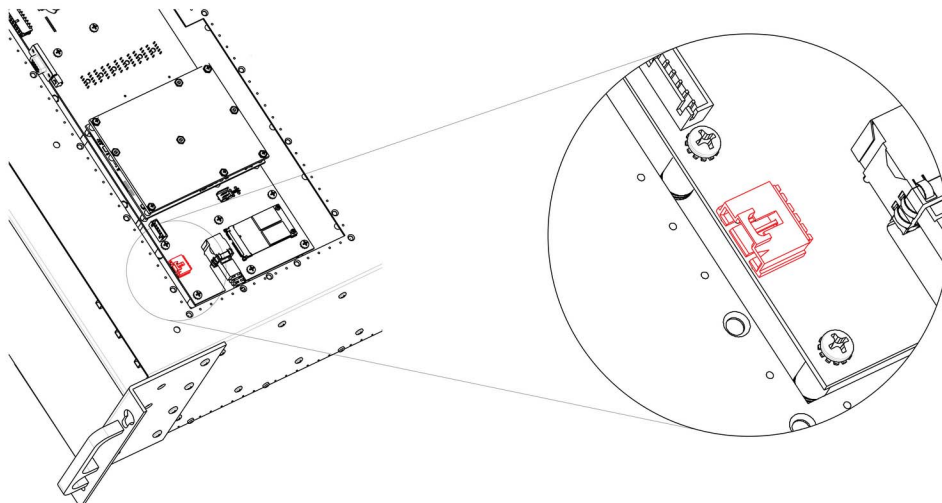

Image 14-62

6. Unplug the USB Extension cable by gently pushing it out.

7. Pull the cable out of the unit.

How to install the USB Extension cable

To install the USB Extension cable follow the same procedure in the reverse order.

14.25 VFD Cable

Flow chart



Image 14-63



The flat ribbon VFD cable connects the VFD assembly to the System Power board. This procedure provides instructions on how to disconnect the cable on both sides.

Concerned parts

R767269K	Cable Kit Set
----------	---------------

Necessary tools

- 1 x Phillips Screwdriver #2
- Hex Screwdriver

How to remove the VFD Cable

1. Partially remove the front panel assembly and pull it away to expose the cables behind it (refer to the related procedure).
2. Push out the side latches on VFD connector to release the VFD cable.

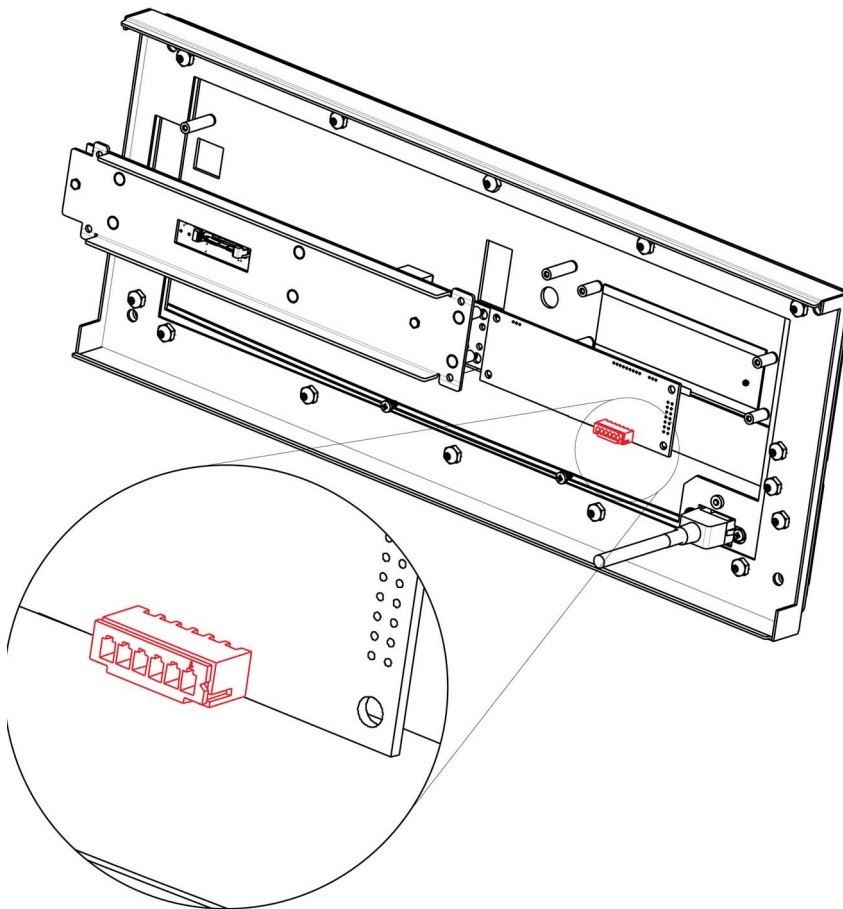

Image 14-64

3. Gently push the cable through the grommet located in the 1RU tray.

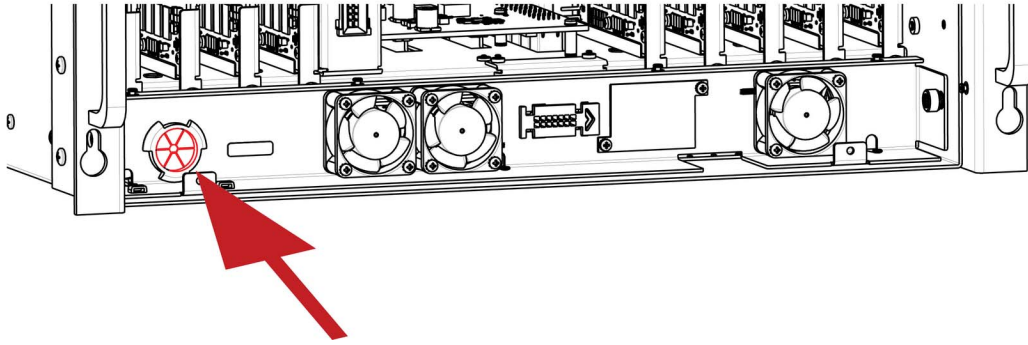

Image 14-65

4. Turn the unit upside down and remove the bottom panel (Follow the instructions provided in the bottom panel removal section).
5. Locate the VFD cable that is plugged on the System-Power board.

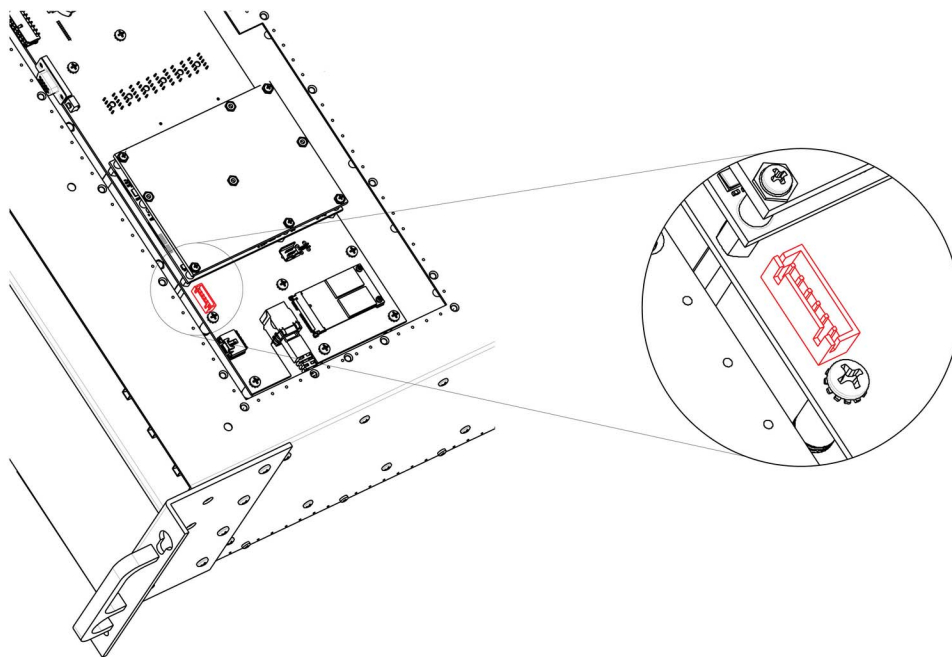

Image 14-66

6. Pull the cable out of the unit .

How to install the VFD Cable

To install the VFD Cable follow the same procedure in the reverse order.

14.26 Keyboard Cable

Flow chart



Image 14-67



The flat ribbon keyboard cable connects the Front panel board to the System-Power board. This procedure provides instructions on how to disconnect the cable on both sides.

Concerned parts

R767269K	Cable Kit Set
----------	---------------

Necessary tools

- 1 x Phillips Screwdriver #2
- Hex Screwdriver

How to remove the Keyboard cable

1. Follow the steps detailed in other procedures to remove the Front Cover Assembly, Front brackets, EMI filter*, 3RU Fan Tray and 1RU Fan Tray. Make sure that the Keyboard Cable is disconnected from the Front Panel board.
Note: *The EMI filter is no longer needed, and it can be removed. If the EMI filter is left in place, it requires servicing. See "E2 maintenance actions", page 374.*
2. Remove the Power supplies from the unit.
3. Turn the unit upside down and follow the steps detailed in other procedures to remove the Bottom Panel and the CPU module from the System-Power board.
4. Remove the USB, VFD, 3RU and 1RU cables that are connected to the System-Power board.
5. Remove the screws that attach the System-Power Board to the standoffs.
6. Lift the System Power Board from the standoffs and flip it over, but don't extend it too much.
7. Locate the keyboard connector and push the latches out to release the cable.

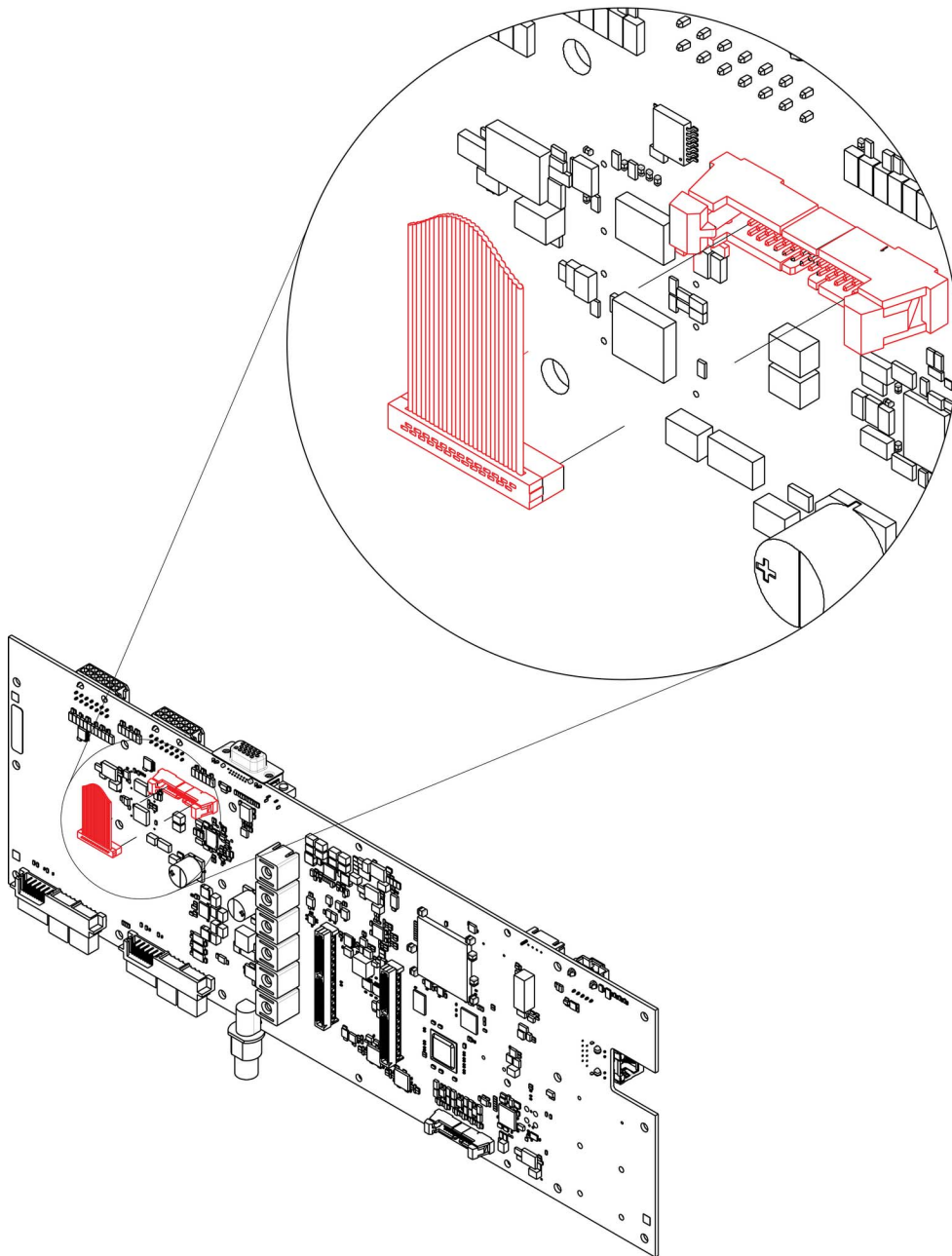

Image 14-68

8. Carefully remove the cable from the unit.

How to install the Keyboard Cable

To install the Keyboard Cable follow the same procedure in the reverse order.



There is a key on the connector to prevent incorrect insertion of the cable.

14.27 Genlock Cable

Flow chart



Image 14-69



The flat ribbon Genlock cable connects the Genlock Assembly to the System-Power board. This procedure provides instructions on how to disconnect the cable on both sides.



Make sure the latches are fully engaged to prevent the cable from coming loose.

Concerned parts

R767269K	Cable Kit Set
----------	---------------

Necessary tools

- 1 x Phillips Screwdriver #2
- Hex Screwdriver

How to remove the Genlock cable

1. Remove the Genlock Assembly and disconnect the Genlock cable from the board. Follow the instructions as provided in the previous section.
2. Turn the unit upside down and follow the steps detailed in other procedures to remove the Bottom Panel and the CPU module from the System-Power board.
3. Remove the USB, VFD, 3RU and 1RU cables that are connected to the System-Power board.
4. Remove the screws that attach the System-Power Board to the standoffs.
5. Lift the System Power Board from the standoffs and flip it over, but don't extend it too much.
6. Unplug the side of the Genlock cable that is plugged into the System Power board.

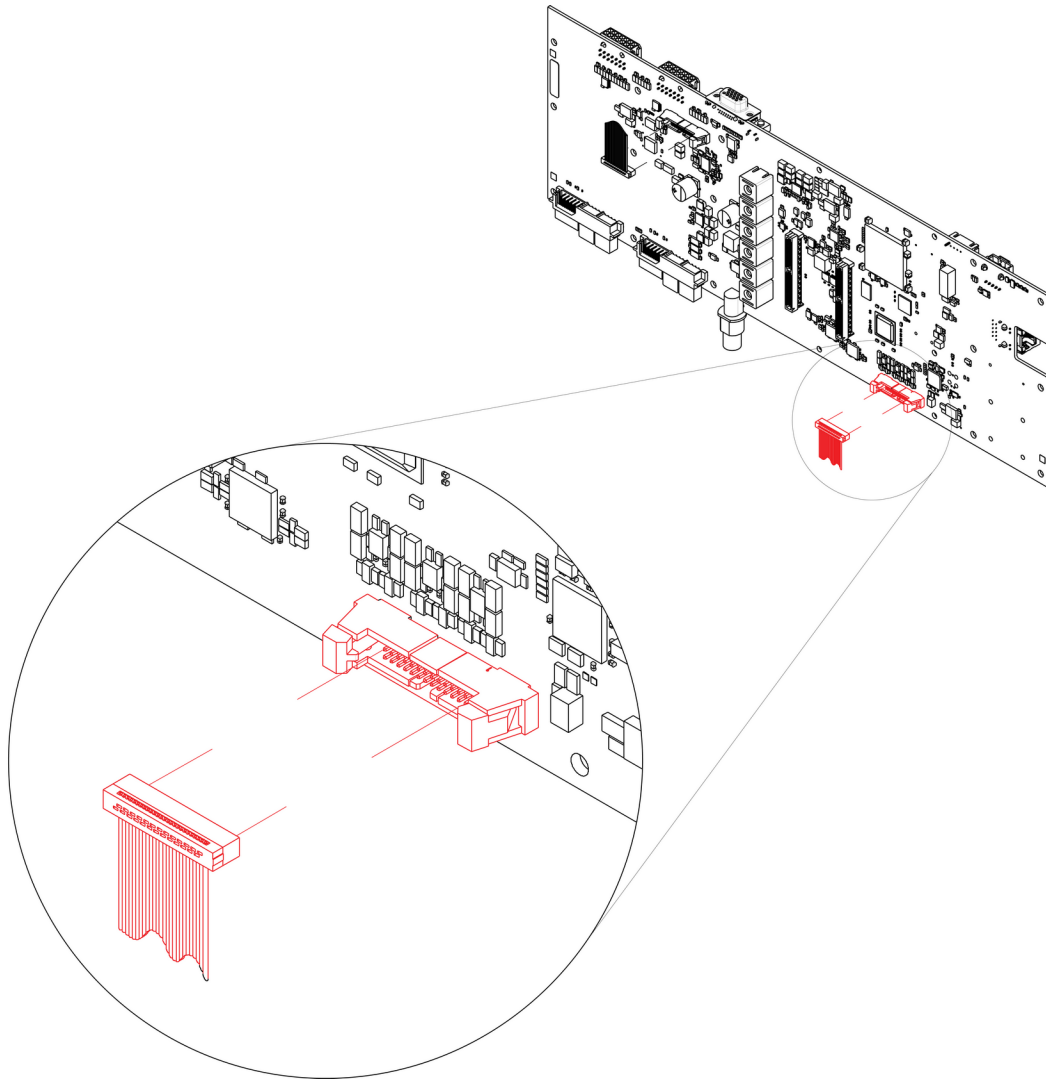

Image 14-70

7. Remove the cable from the unit.

How to install the Genlock Cable

To install the Genlock Cable follow the same procedure in the reverse order.



There is a key on the connector to prevent incorrect insertion of the cable.



Make sure the latches are fully engaged to prevent the cable from coming loose.

14.28 Ethernet Cable

Flow chart



Image 14-71



The Ethernet cable connects the Genlock board to the System Power board. This procedure provides instructions on how to remove the cable from both sides.

Concerned parts

R767269K	Cable Kit Set
----------	---------------

Necessary tools

1 x Phillips Screwdriver #2

How to remove the Ethernet cable

1. Follow the steps detailed in other procedures to remove Ethernet cable from the Genlock assembly.
2. Turn the unit upside down and follow the steps detailed in other procedures to remove the Bottom Panel and the CPU module from the System-Power board.
3. Remove the USB, VFD, 3RU and 1RU cables that are connected to the System-Power board.
4. Remove the screws that attach the System-Power Board to the standoffs.
5. Lift the System Power Board from the standoffs and flip it over, but don't extend it too much.
6. Locate the Ethernet connector and push the locking clip on the Ethernet cable so it can be released from the socket.

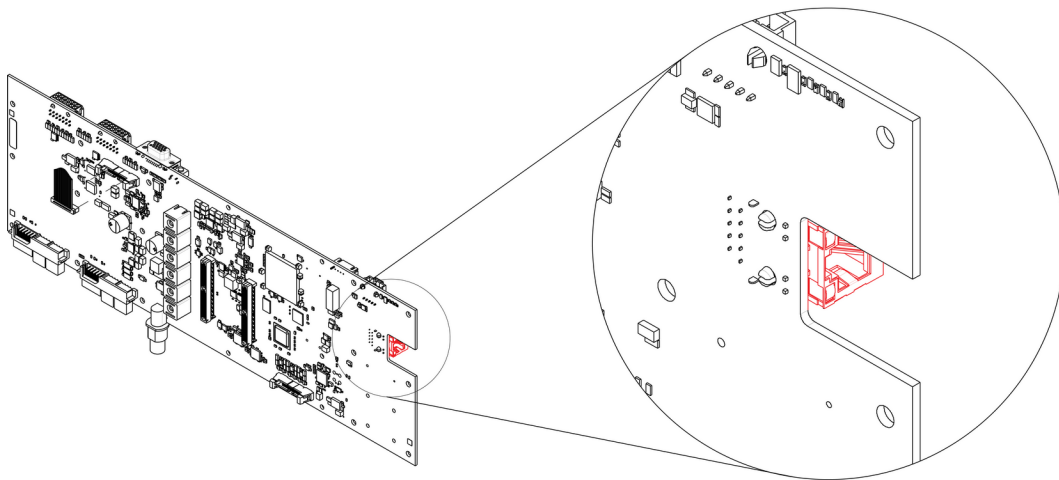

Image 14-72

7. Carefully remove the cable from the unit.

How to install the Ethernet Cable

To install the Ethernet Cable follow the same procedure in the reverse order.

14.29 3RU Fan Cable

Flow chart



Image 14-73



The 3RU cable assembly provides power to the 3RU fans from the System-Power board.



One side of the cable is attached to a metal bracket that is accessible after the 3RU fan tray is removed. The other side of the cable assembly connects to the System-Power board and is accessible when the bottom panel is removed

Concerned parts

R767269K	Cable Kit Set
----------	---------------

Necessary tools

- 1 x Phillips Screwdriver #2
- Hex Screwdriver

How to remove the 3RU Fan cable

1. Make sure the unit is placed in the upright position and the 3RU fan tray is removed
2. Locate the 3RU cable connector that is exposed after the 3RU fan tray is removed. The connector is attached on a metal bracket that is vertically mounted in the chassis.

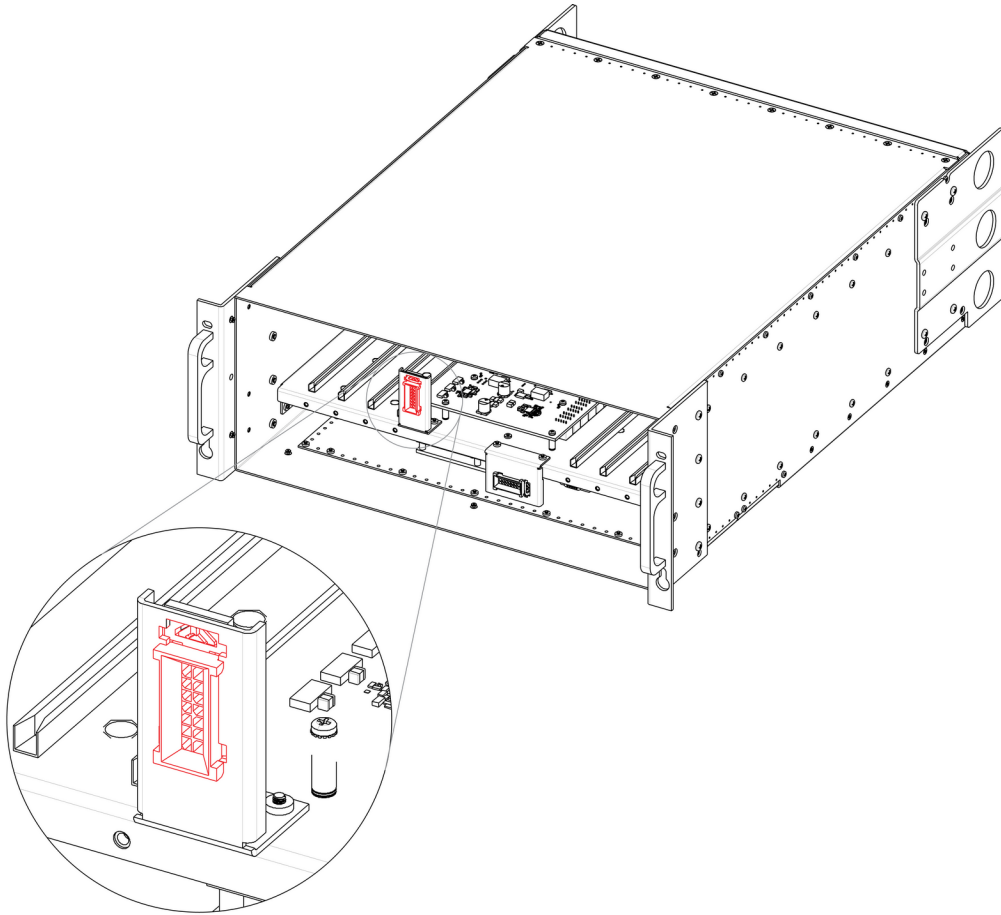

Image 14-74

3. Locate the snap lock on the top of the connector and push it back to release the connector from the bracket.

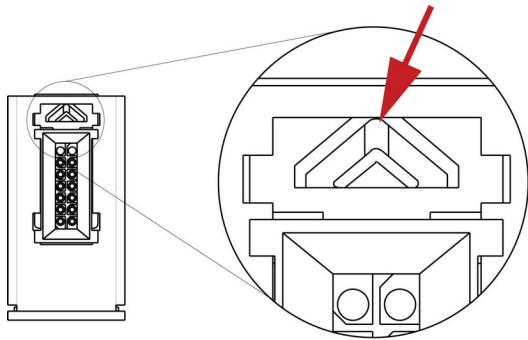

Image 14-75

4. Push the connector up until the slots in the metal bracket align with the flanges on the connectors.

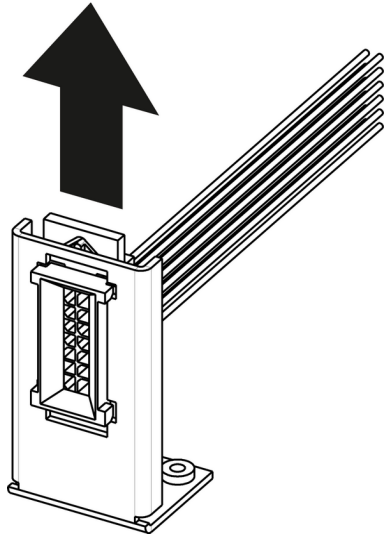

Image 14-76

5. Gently pull the 3RU cable assembly away from the bracket.

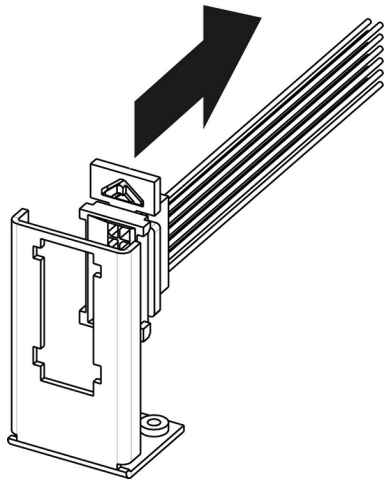

Image 14-77

6. Turn the unit upside-down and remove the bottom panel.
7. Locate the 3RU cable that is plugged on the System-Power board.

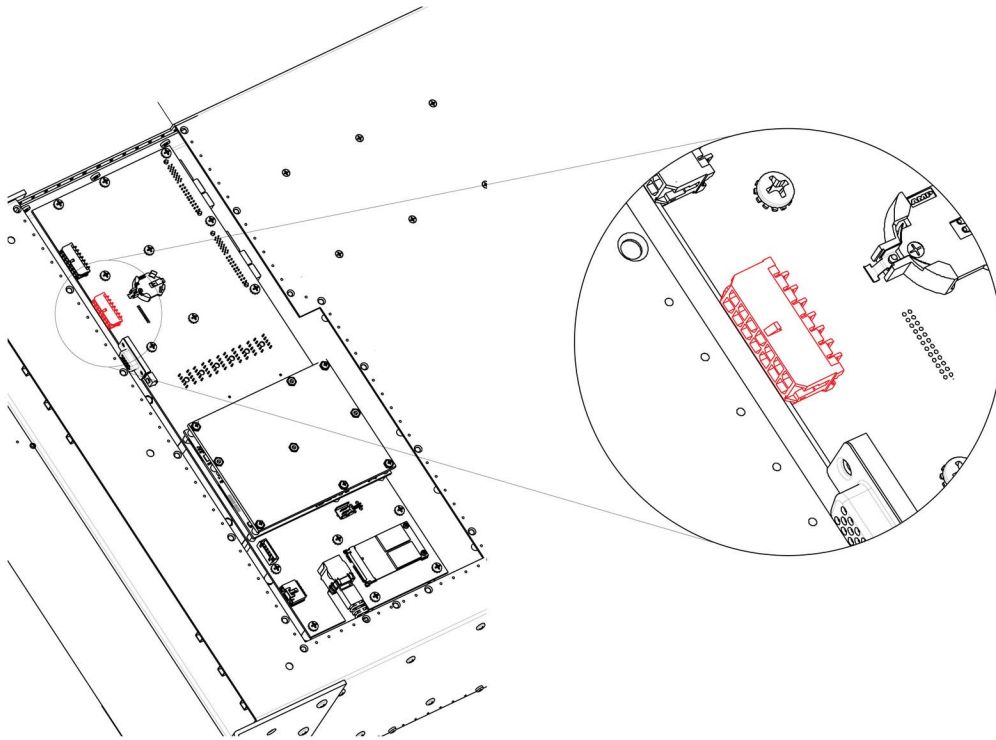

Image 14-78

8. Remove the 3RU cable by gently pushing it out.

How to install the 3RU Fan Cable

To install the 3RU Fan Cable follow the same procedure in the reverse order.

14.30 1RU Fan Cable

Flow chart



Image 14-79



The 1RU cable assembly provides power to the 1RU fans from the System-Power board.



One side of the cable is attached to a metal bracket that is accessible after the 3RU and the 1RU fan trays are removed. The other side of the cable assembly connects to the System-Power board and is accessible when the bottom panel is removed.

Concerned parts

R767269K	Cable Kit Set
----------	---------------

Necessary tools

- 1 x Phillips Screwdriver #2
- Hex Screwdriver

How to remove the 1RU Fan cable

1. Make sure the unit is placed in the upright position and the 3RU and 1RU fan trays are removed.
2. Locate the 1RU cable connector that is exposed after the 1RU fan tray is removed. The connector is attached on a metal bracket that is horizontally mounted in the chassis.

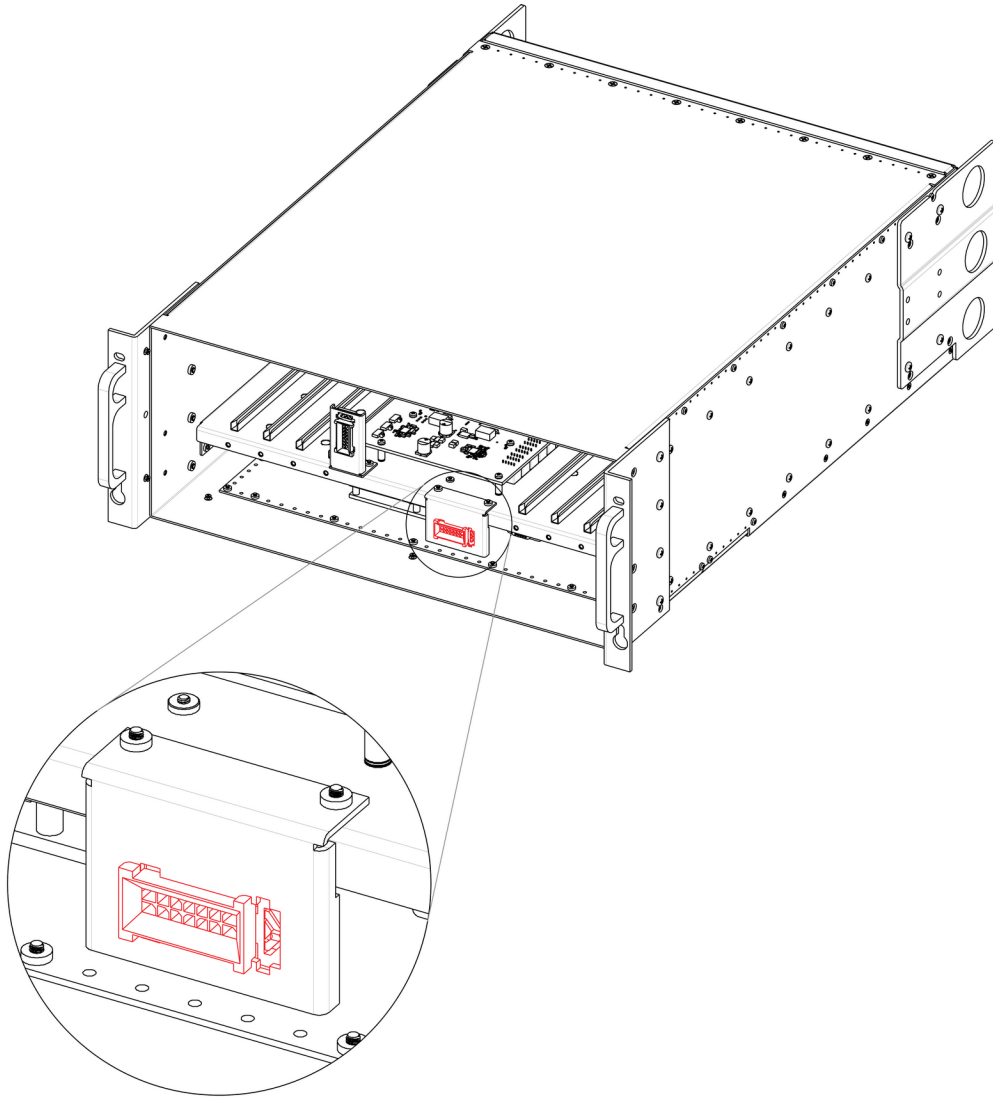

Image 14-80

3. Locate the snap lock on the connector and push it back to release the connector from the bracket.

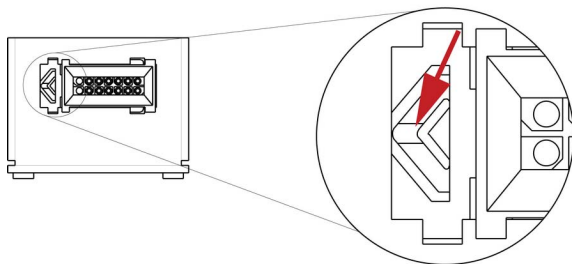

Image 14-81

4. Push the connector to the left until the slots in the metal bracket align with the flanges on the connectors.

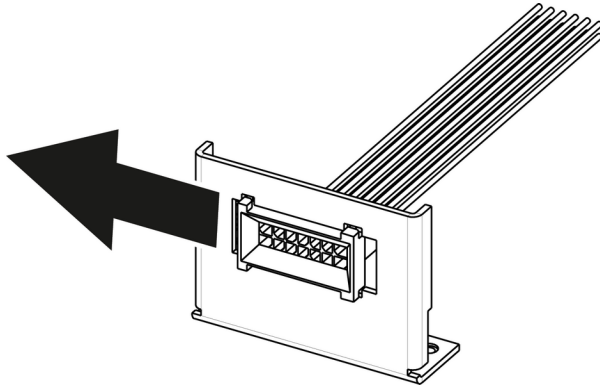

Image 14-82

5. Gently pull the cable away from the bracket.

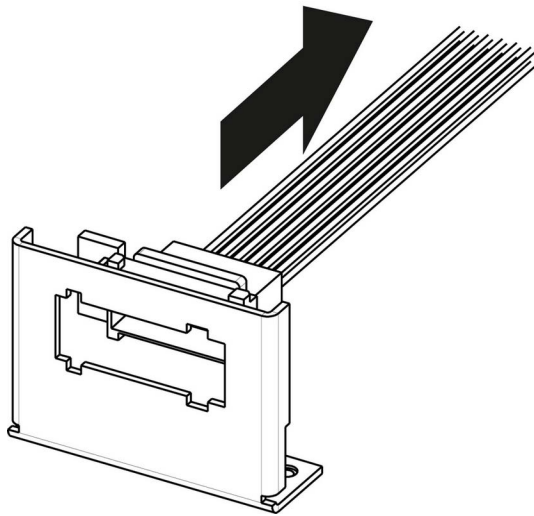

Image 14-83

6. Turn the unit upside-down and remove the bottom panel.
7. Locate the 1RU cable that is plugged on the System-Power board.

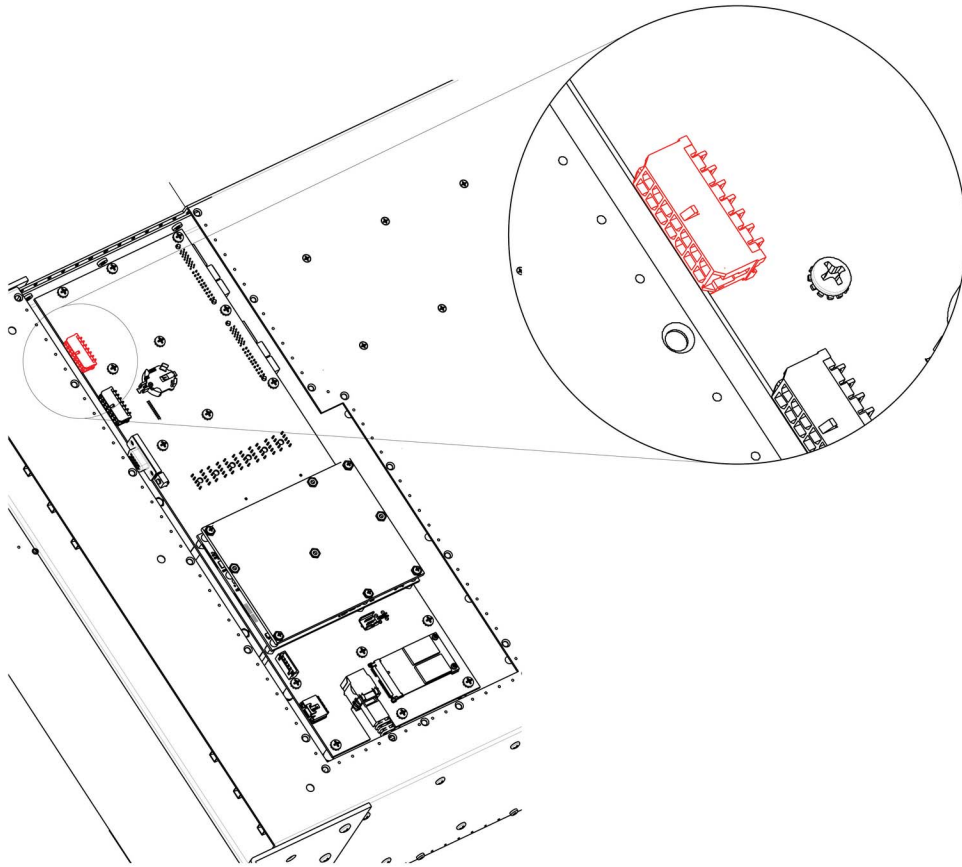

Image 14-84

8. Remove the 1RU cable by gently pushing it out.

How to install the 1RU Fan Cable

To install the 1RU Fan Cable follow the same procedure in the reverse order.

14.31 Rear Rack Ears

Concerned parts

R767273K	Connector protector
----------	---------------------

Necessary tools

1 x Phillips Screwdriver #2

How to remove Rear Rack-Ears

1. Remove the eight pan head screws (8-32x.31), four from each side, to detach the rear rack ears and connector protectors from the unit.

Note: If the rear rack ears have been removed, do not re-install the 8-32x.31 screws. Without the rack ears in place, the screws may damage the multiviewer card.

Note: You don't need to remove the rear rack ears to access any other part of the unit.

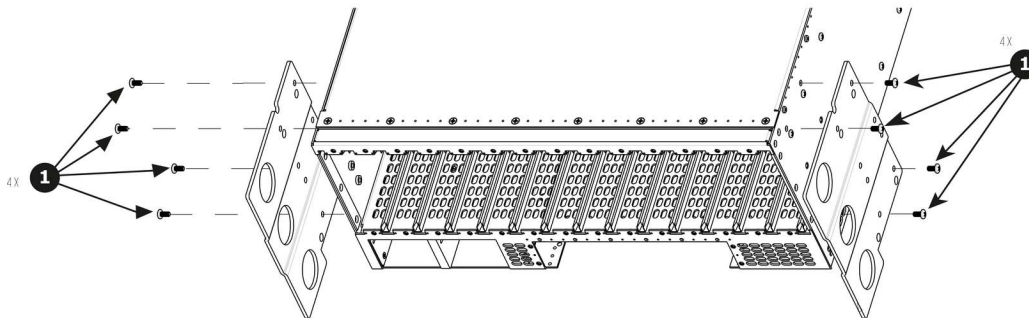

Image 14-85

How to install Rear Rack-Ears

To install the Rear Rack-Ears follow the same procedure in the reverse order.



When shipping an E2 in a Barco-supplied case, make sure that the rear connector protectors are installed to prevent damage.

14.32 Front Rack-Ears

Flow chart

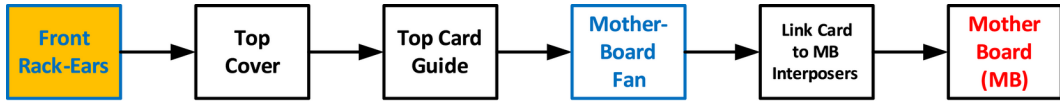

Image 14-86

Concerned parts

R767268K	Rack Ears kit
----------	---------------

Necessary tools

1 x Phillips Screwdriver #2

How to remove Side Rack-Ears

1. Loosening and removing the eight (four on each side) pan head screws that secure the brackets to the chassis sides.

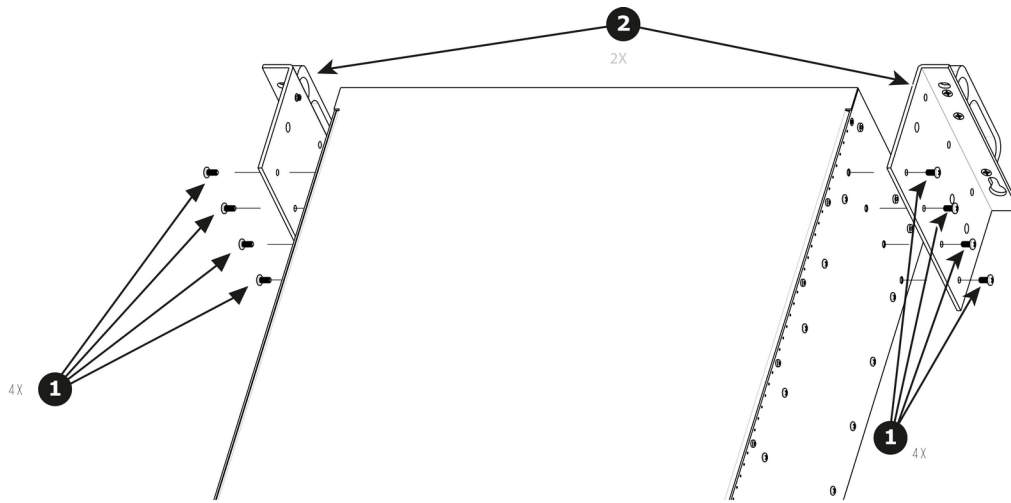

Image 14-87

2. Remove the Rack-Mount Brackets from the Chassis.

How to install Side Rack-Ears

To install the Side Rack-Ears follow the same procedure in the reverse order.

14.33 Top Cover

Flow chart

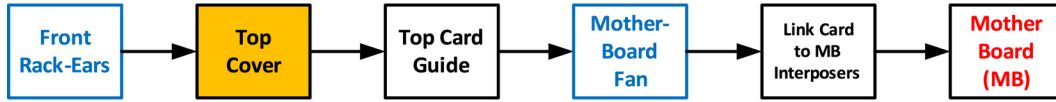

Image 14-88

Necessary tools

1 x Phillips Screwdriver #2

How to remove Top Cover

1. Remove the 12 screws from the two sides (6 in each side, 4-40x0.25) that are located towards the top side of the unit.
2. Remove the two (2) screws (4-40x0.25) located closer to the rear end of the unit. These are flat head screws.
3. Remove the 8 screws (6-32x0.25) located on the top at the back of the chassis.
4. Remove the cover by gently pulling it away from the E2

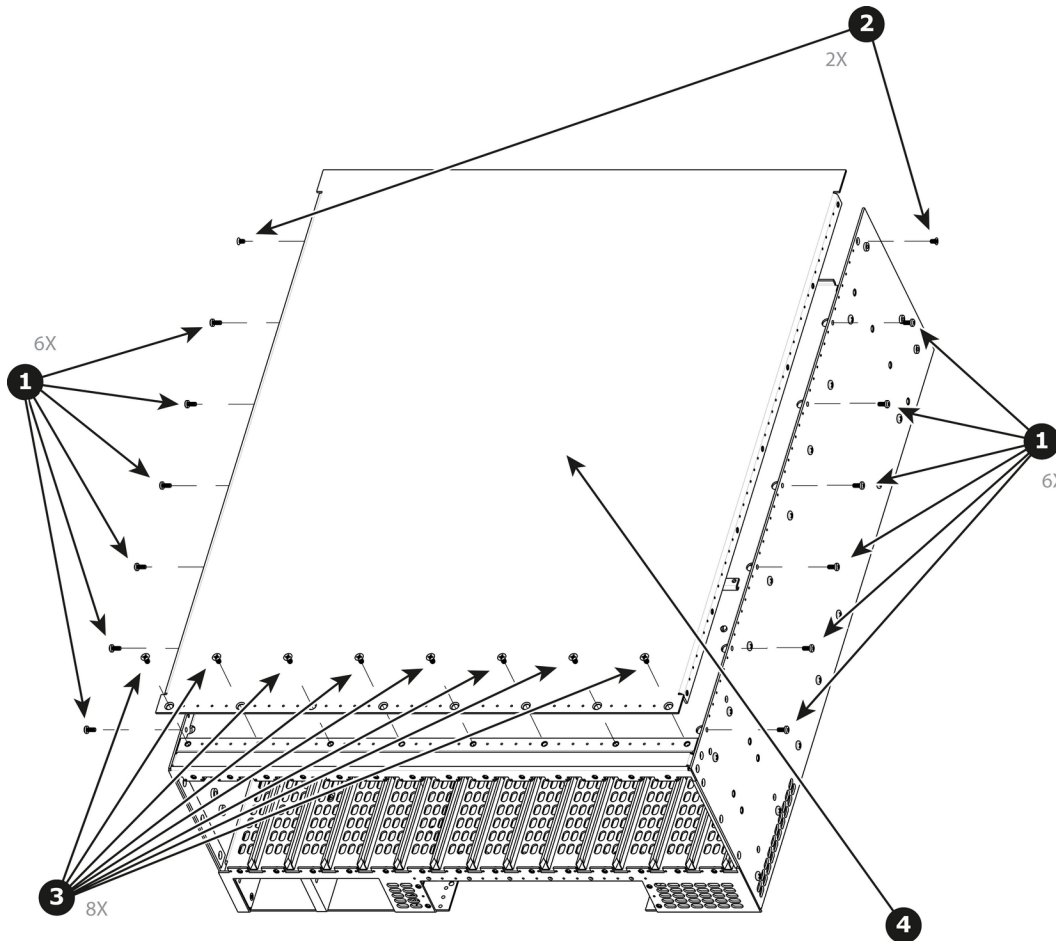

Image 14-89

How to install Top Cover

To install the Top Cover follow the same procedure in the reverse order.

14.34 Top Card Guide

Flow chart

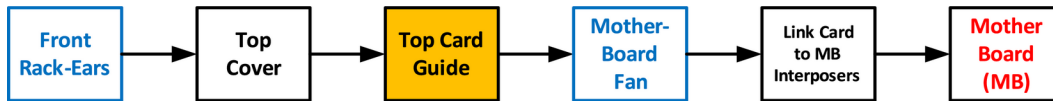

Image 14-90

Necessary tools

1 x Phillips Screwdriver #2

How to remove Top Card Guide

1. Remove the 18 screws from the two sides (8 in each side, 6-32x0.25) that are located towards the bottom of the unit.
2. Remove the card guide cover by gently pulling it away from the E2.

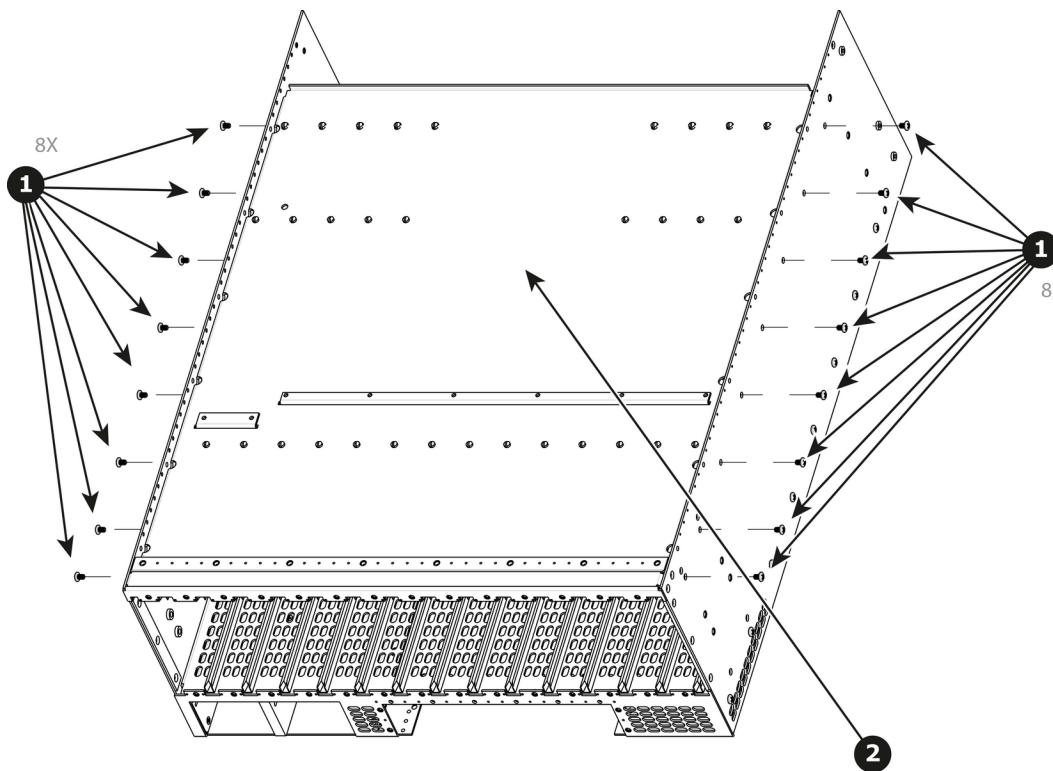

Image 14-91

How to install Top Card Guide

To install the Top Card Guide follow the same procedure in the reverse order.



When installing the guide make sure you have 2 cards from the rear and two cards from the front (VPUs) installed before tightening the screws.



Use Loctite 242 to the screws before installing.

14.35 Motherboard Fan

Flow chart

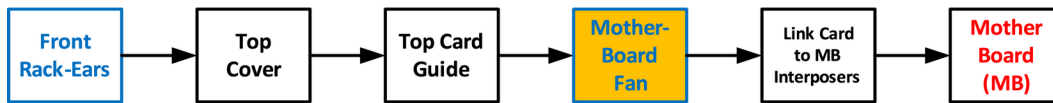

Image 14-92

Overview

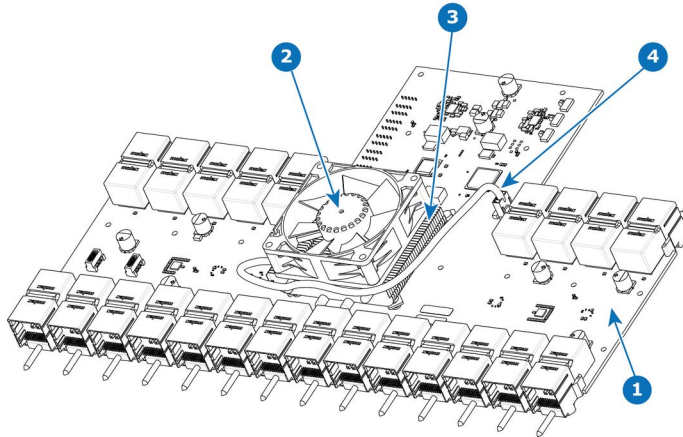

Image 14-93

- 1 Motherboard
- 2 Fan
- 3 Heatsink
- 4 Fan power cable

Concerned parts

R767265K	Motherboard Heatsink & Fan kit
----------	--------------------------------

Necessary tools

- 1 x Phillips Screwdriver #2

How to remove Motherboard Fan

1. Remove the cable that provides power to the heatsink fan.
2. Lift the two handles to release the fan from the heatsink.

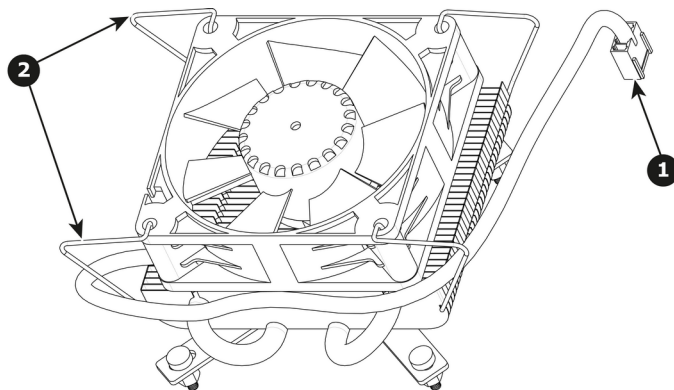

Image 14-94

3. Lift the fan away from the heatsink.

How to install Motherboard Fan

1. Remove the fan from the Heatsink/Fan spare kit.
2. Using the clips install the fan on the top of the heatsink that is on the motherboard.
3. Connect the fan power cable to header xxx located on the motherboard.



Disregard the heatsink from the spare kit.

15. S3 MAINTENANCE

About this chapter

This chapter describes how to service a S3 series Event Master Processor by replacing individual components.

Simple servicing

S3 series devices are based on a modular design that ensures easy serviceability. Users can swap most of the S3 components in the case of damage, without shipping the unit to a Barco service center.

Methodology

Most procedures in these chapters include multiple steps to gain access to the parts requiring service. A workflow flow chart is provided next indicating all of the procedures and their relationships. Please refer to the chart to familiarize yourself with the sequence of procedures.

ESD recommendations

The following precautions must be taken:

- Perform the Service procedures only at approved anti-static work station equipped with anti- static mat.
- At all times use a conductive wrist strap attached to a solid earth ground.
- Always discharge yourself by touching a grounded bare metal surface before coming in contact with ESD sensitive electronic.



WARNING: Always switch power off and unplug the cords from the device before performing any maintenance operations described in this chapter.



WARNING: The device can be damaged by electrostatic discharge (ESD). When handling the device and any of its components, caution must be taken so that damage does not occur. Damage due to inappropriate handling is not covered by the warranty.

Overview

- S3 unit Overview
- Process Overview
- Spare Parts Serviceable by All Users
- Rear I/O, Link and VPU Cards
- Rear I/O, VPU and Link card Heatsink Fan
- Front Cover Assembly
- Front Brackets
- 3RU Fan Tray
- Front Panel Knob
- Front Panel Mount
- Front Panel Board
- VFD Display Assembly
- VFD Display Filter
- USB Cable
- USB Extension Cable
- Power Supply
- Genlock Assembly
- Rear Rack Ears
- Front Rack-Ears
- Top Cover
- Top Card Guide
- Motherboard Fan
- Power Interposer Assembly
- Power Supply Guide
- Side support plate
- Link Card Interposer
- CPU Module
- Solid-State Memory
- System Battery
- VFD Cable
- Keyboard Cable
- 3RU Fan Cable
- Ethernet Cable
- Genlock Cable

15.1 S3 unit Overview

Orientation and main components

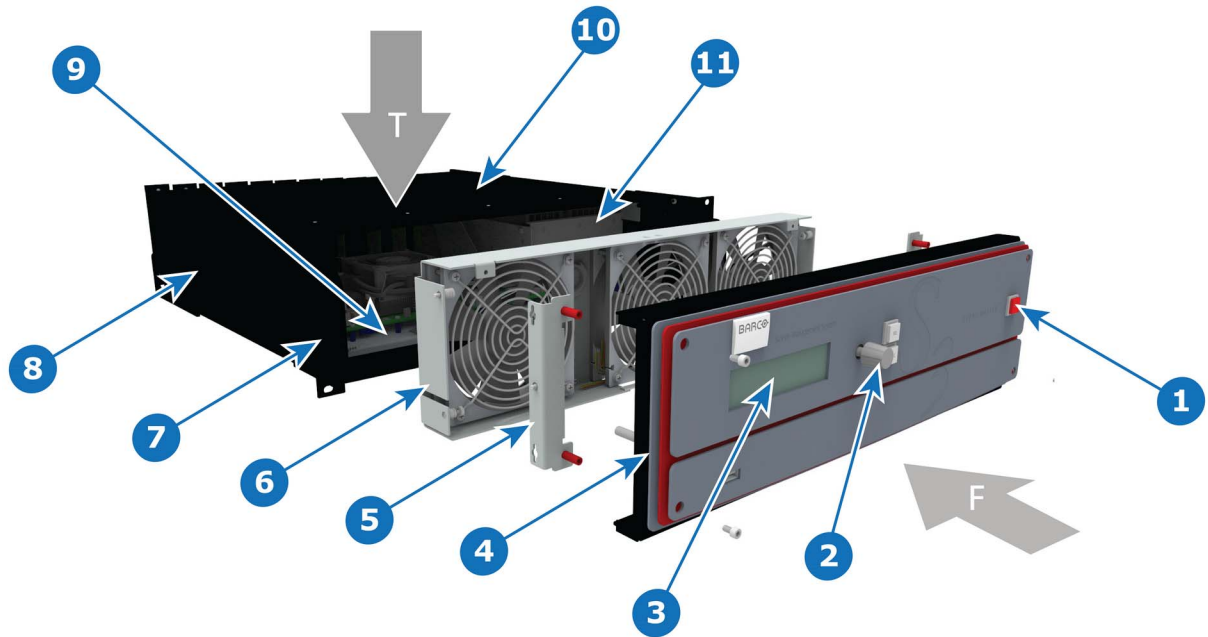

Image 15-1

T	Top	6	3RU Fan Tray
F	Front	7	Rack Ears
1	On/Off	8	Chassis
2	Front Panel Knob	9	Motherboard
3	VFD Display	10	Top Cover
4	Front Cover Assembly	11	Power Interposer Assembly
5	Front Brackets		

15.2 Process Overview

Flow chart

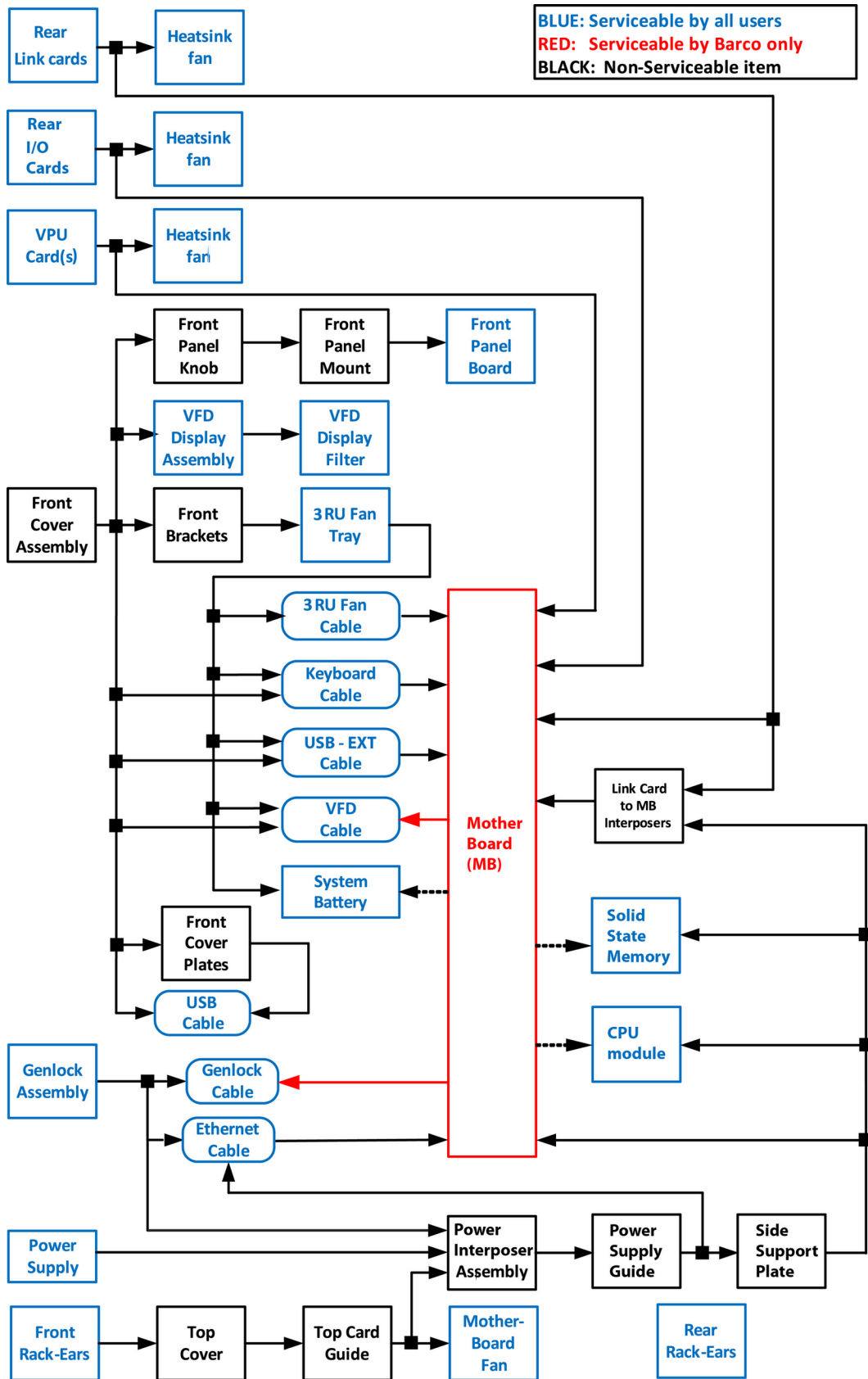

Image 15-2

15.3 Spare Parts Serviceable by All Users

S3 Spare Parts list

P/N	Description	Comments
R767241K *	VFD Display assembly	
R767246K *	VFD Filter	
R767260K *	Front Panel board	
R767263K *	Heatsink fan	One for each Input, Output, Link and VPU card
R767264K *	CPU module	
R767265K *	Motherboard Heatsink & Fan kit	
R767267K *	Power supply(PS)	One PS only. System accepts two Power supplies
R767275K *	Solid-State Memory	
R767278K	MOTHERBOARD S3	
R767279K	POWER INTERPOSER S3	
R767280K *	3RU fan tray	The fans are not available separately — will replace R767271K
R767281K	FRONT RACK EARS S3	Includes hardware for both sides
R767282K	REAR CONNECTOR PROTECTOR S3	
R767283K	S3 Cable Kit	Kit contains: <ul style="list-style-type: none"> • 1x USB Extension cable • 1x Fan Tray-to-Motherboard cable • 1x RJ45-to-Motherboard CAT5 Ethernet cable • 1x Front Panel Keyboard-to-Motherboard flat cable • 1x Genlock-to-Motherboard flat cable • 1x VFD-to-Motherboard cable
V327007 *	System Battery	
R9004740 *	DVI Input Board	
R9004741 *	SDI Output Board	
R9004742 *	SDI Input Board	
R9004743 *	HDMI Output Board	
R9004744 *	DP/HDMI Input Board	
R9004745 *	DVI Output Board	Not available in release 1
R9004746 *	Link Card Board	
R9004750 *	Link/CXP Cable	
R9004758	VPU CARD S3	
R9004759	GENLOCK S3	
R9004760	GENLOCK/S3D S3	
R9004785 *	Tri-Combo Input Board	
R9004786 *	Tri-Combo Output Board	

(*) common between E2 and S3.

Optional CXP Cables

P/N	Description	Comments
R9004753	CXP Fiber Cable	1x 30M Fiber cable
R9004754	CXP Fiber Cable	1x 100M Fiber cable
R9004761	CXP Cable	1x 3M cable
R9004762	CXP Cable	1x 5M cable
R9004763	CXP Cable	2x 3M cables
R9004764	CXP Cable	2x 5M cables

15.4 Rear I/O, Link and VPU Cards

Flow chart

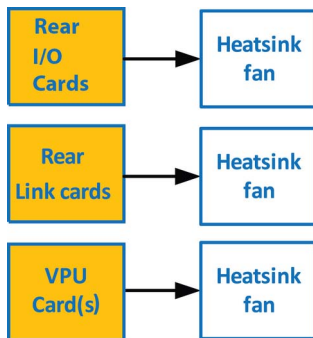

Image 15-3

Overview

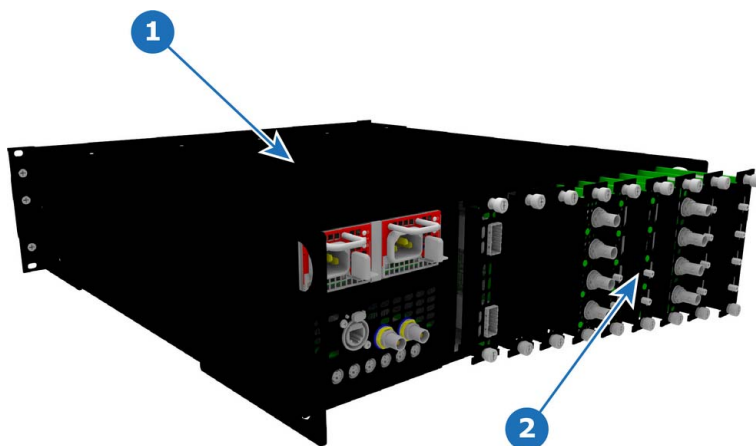

Image 15-4
 1 Chassis
 2 I/O, Link and VPU cards

Concerned parts

R9004740	DVI Input
R9004741	SDI Output
R9004742	SDI Input
R9004743	HDMI Output
R9004744	DP/HDMI Input
R9004745	DVI Output
R9004746	Link Card
R9004758	VPU card S3
R9004785	Tri-Combo Input
R9004786	Tri-Combo Output

Necessary tools

Phillips Screwdriver #2.

How to remove a card

1. Locate the card you wish to replace.
Note: There are 9 card slots. The first slot on the left is slot 1 and the last slot on the most right position is 9.
2. Loosen and unscrew the top and bottom thumbscrews that are holding the card to the chassis.
3. Gently pull the card out of its slot.
Tip: You may need to wobble it a little bit up or down to loosen it from the card guides as you are pulling out.

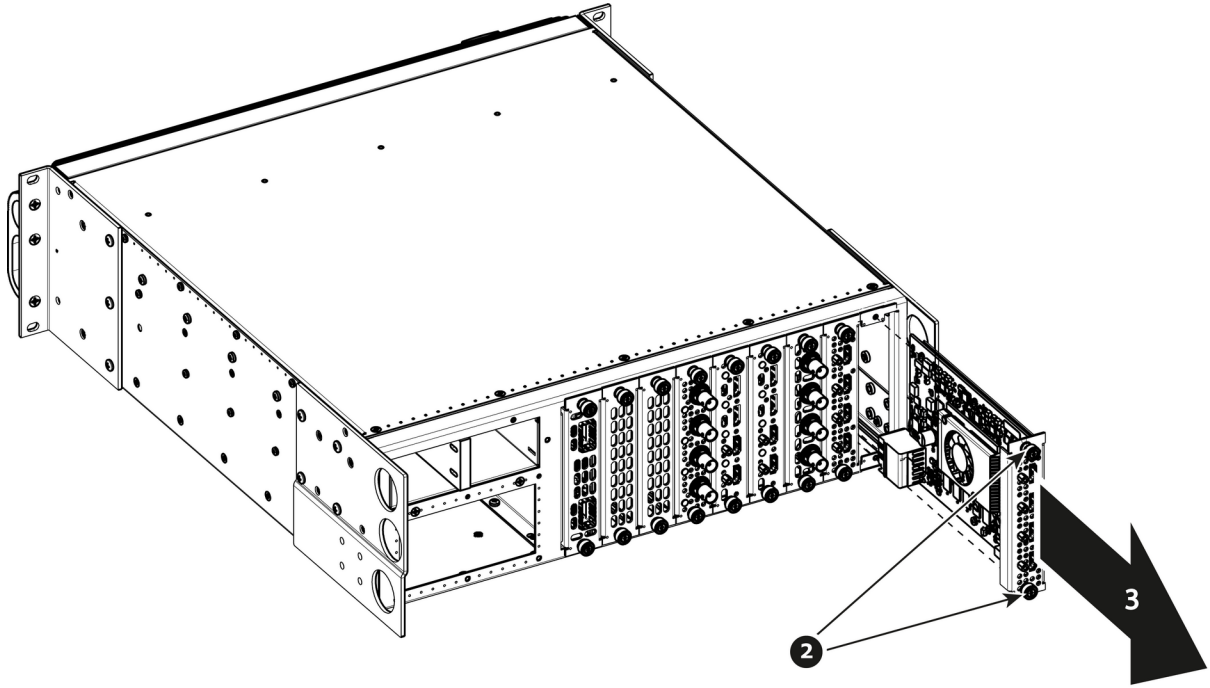

Image 15-5

How to install a card

To install a card follow the same procedure in the reverse order.



Apply a little pressure on the card until it is fully inserted in the back plane connector.

15.5 Rear I/O, VPU and Link card Heatsink Fan

Flow chart

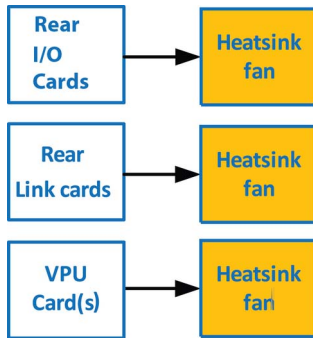

Image 15-6

Overview

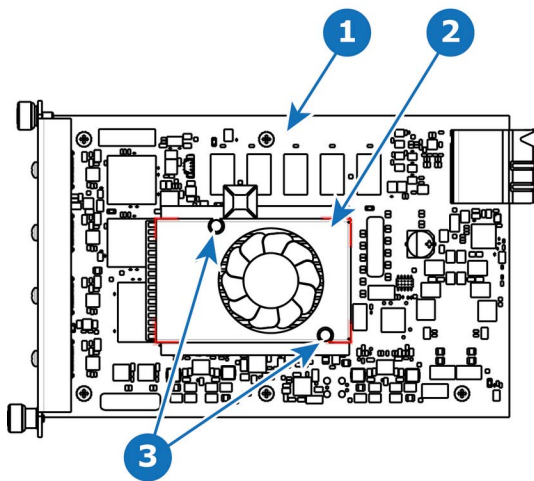

Image 15-7

- 1 I/O board
- 2 Heatsink Fan
- 3 Pins

Concerned parts

R767263K	Heatsink Fan
----------	--------------

Necessary tools

- 1 x Phillips Screwdriver #2.
- Small fine nose pliers.

How to remove the Rear I/O, VPU and Link card Heatsink Fan

1. After you remove the card from the chassis, unplug the heatsink fan power wire from the PCB connector.
2. Locate the two pins that are located on opposite corners of the Heatsink and secure the fan on to the board.
3. Turn the board over and with small fine nose pliers while bringing together the two sides of the pin push it through the hole.
4. After both pins are pushed through the holes, you can remove the heatsink from the card.

How to install the Rear I/O, VPU and Link card Heatsink Fan

1. Remove the heatsink with the fan from the package.
2. Remove the plastic cover from the bottom of the fan to expose the adhesive material.
3. Align the holes in the board with the pins of the Heatsink.
4. Press firmly the heatsink to the devices below.
5. Plug the heatsink fan power wire to the PCB connector.

15.6 Front Cover Assembly

Flow chart

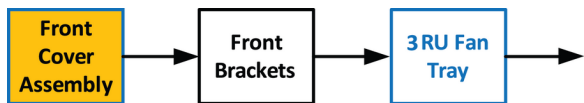

Image 15-8

Overview



Image 15-9

- 1 Front Cover Assembly
- 2 Front Brackets
- 3 3RUFanTray
- 4 Event Master Unit

Necessary tools

1 x Screwdriver HEX 0.05" 7.05" (Provide by Barco in the original package).



Image 15-10

How to remove the Front Cover Assembly

1. Use the Hex screwdriver to remove the 4 screws (Hex 6-32x.25) that attach the front cover to the brackets located behind it.
Note: the standoffs go through the holes in sheet metal to properly align the front enclosure.

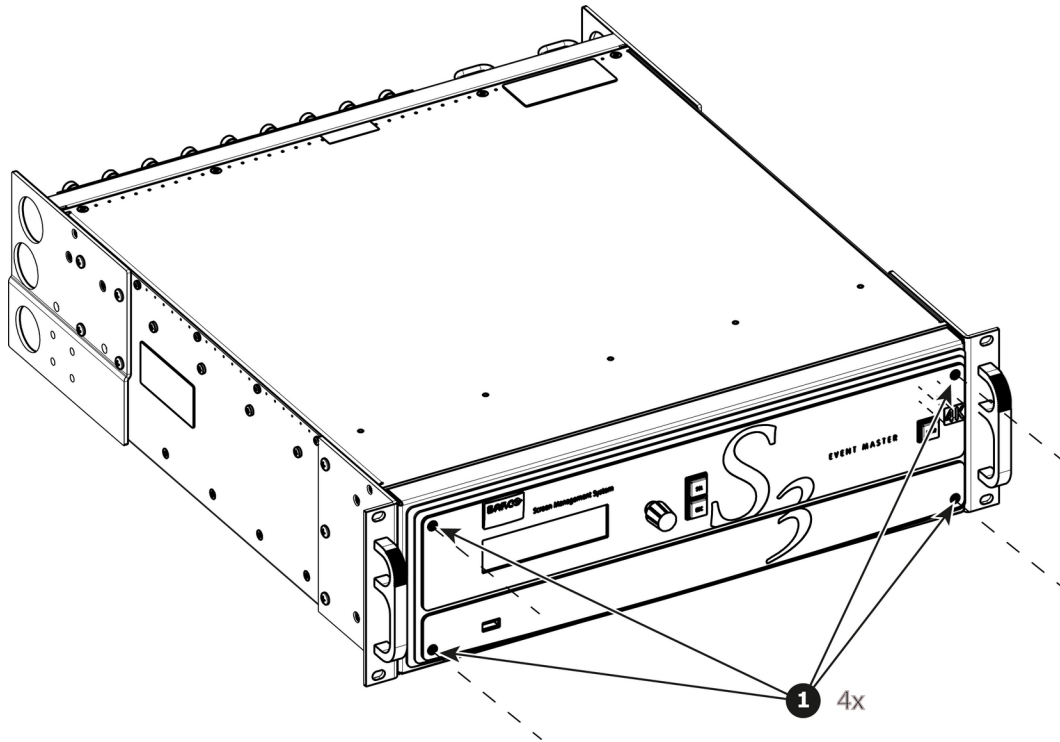

Image 15-11

2. Pull out the Front cover and lay it flat in front of the unit.

At this point there are still 3 cables connecting the Front cover to the unit.

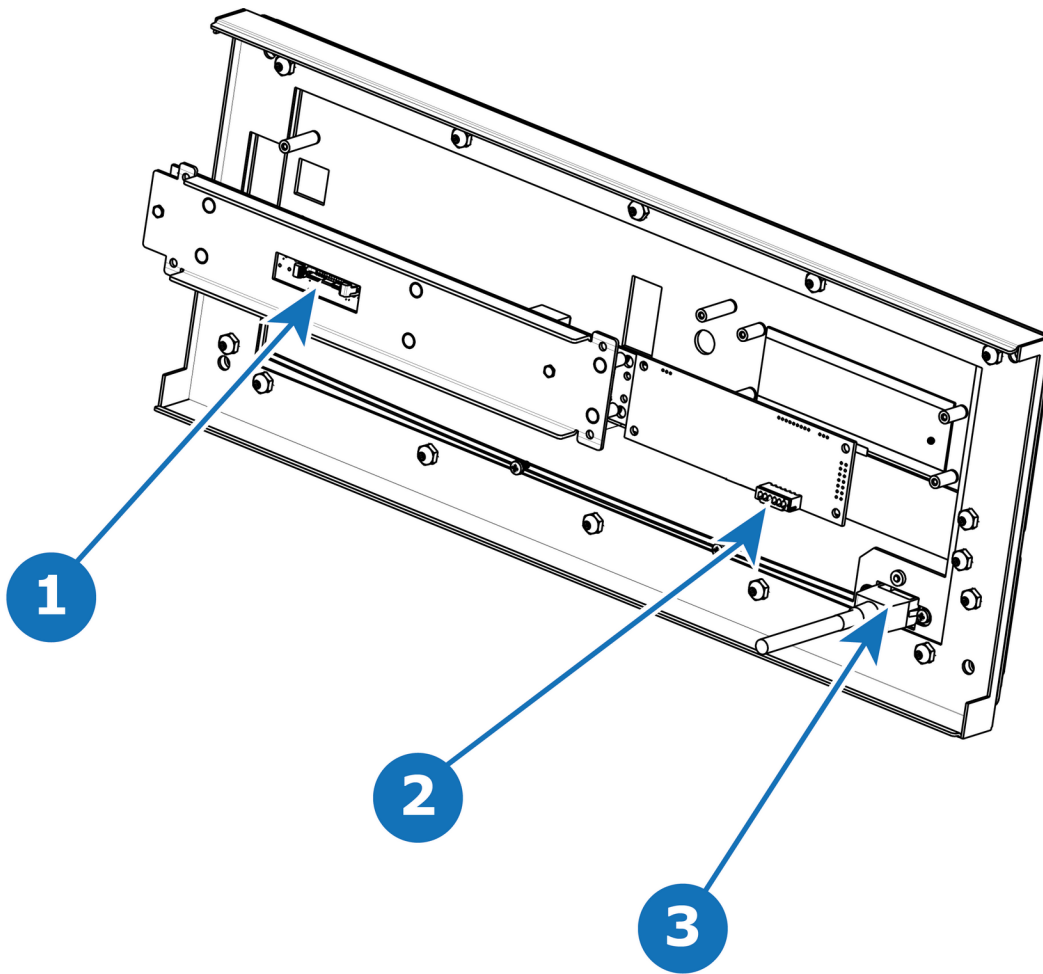

Image 15-12

- 1 Front Panel Connector
- 2 VFD Connector
- 3 USB Connector

3. Pull the latches away from connectors and gently pull the flat Front Panel away.
4. Remove cables as outlined in the related procedures (VFD, USB and Front Panel connectors).

How to install the Front Cover Assembly

To install the Front Cover Assembly follow the same procedure in the reverse order.

15.7 Front Brackets

Flow chart

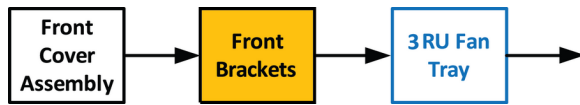

Image 15-13

Necessary tools

None.

How to remove the Front Brackets

1. Remove the two front brackets by lifting them up and then pulling them inwards and then out.

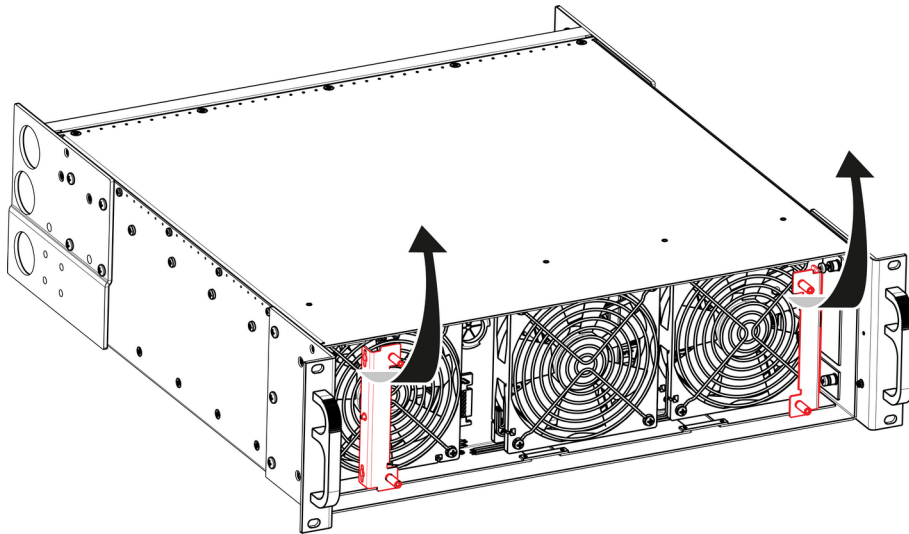

Image 15-14

How to install the Front Brackets

To install the front Brackets follow the same procedure in the reverse order.

15.8 3RU Fan Tray

Flow chart

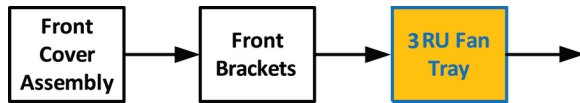

Image 15-15

Concerned parts

R767280K	3RU Fan Tray
----------	--------------

Necessary tools

1 x Phillips Screwdriver #2 (optional).

How to remove the 3RU Fan Tray

- Loosen and unscrew the 4 thumbscrews holding the 3RU fan tray to the chassis.
Note: You may need a screwdriver if the thumbscrews are very tight.
- Pull the tray out.
Note: You need to tilt the tray and maneuver it to go around the dimples located on the side of the chassis.

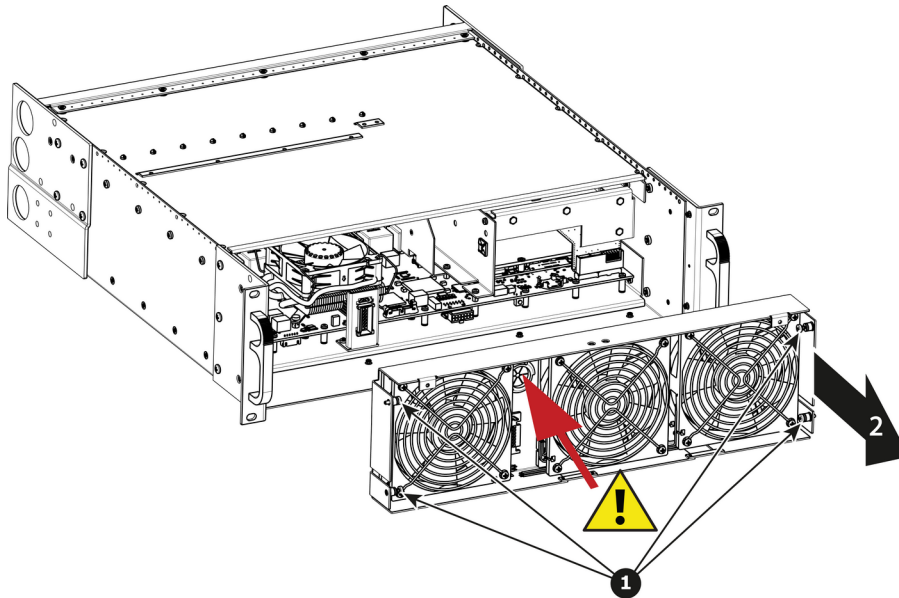

Image 15-16

Caution: Before you completely remove it from the unit carefully push the USB and Front panel cables through the grommet located between the two fans at left hand side.

How to install the 3RU Fan Tray

Follow the same procedure in the reverse order and in addition perform the following:

- Pass the USB and VFD cable through the grommet.
- Make sure that the front panel flat cable (keyboard cable) goes through the slot located on the bottom side.

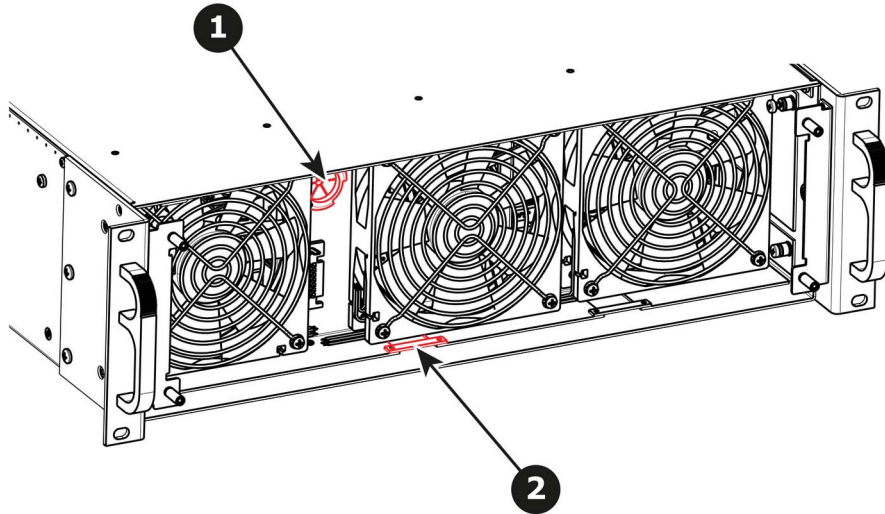

Image 15-17

3. Line up the connector behind the fan tray and the connector on the motherboard behind it and push so the two connectors mate.

15.9 Front Panel Knob

Flow chart

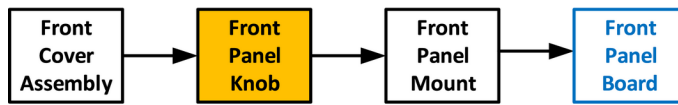

Image 15-18



Before you proceed removing the Front panel knob you need to remove the Front Cover Assembly as outlined in the related procedure.

Necessary tools

- Knob removal tool provided by Barco



Image 15-19

- Flat head screwdriver or a tool with a sharp edge

How to remove the Front Panel Knob

1. Remove the knob cover with a flat screw driver or a sharp object to expose the inside of the knob.

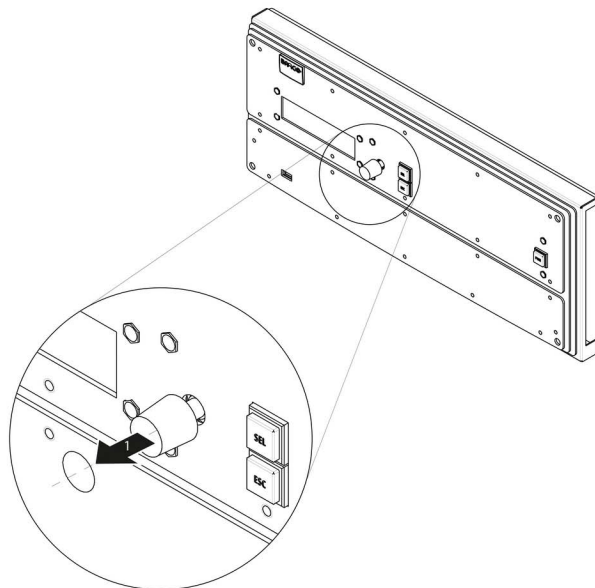

Image 15-20

2. Use the knob removal tool provided by Barco to take out the knob. Align the notches on the tool with the grooves in the knob as indicated below.

Note: If the tool is not available use fine point needle nose pliers to squeeze at knob between the two grooves while pulling it out.



Image 15-21

How to install the Front Panel Knob

To install the Front Panel Knob follow the same procedure in the reverse order.

15.10 Front Panel Mount

Flow chart

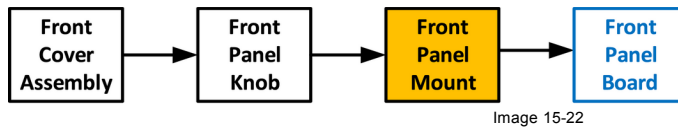

Necessary tools

1 x Phillips Screwdriver #2

How to remove the Front Panel Mount

1. Turn the Front Cover over and remove the four screws (4-40X.25) that secure the control panel mount to the front panel.

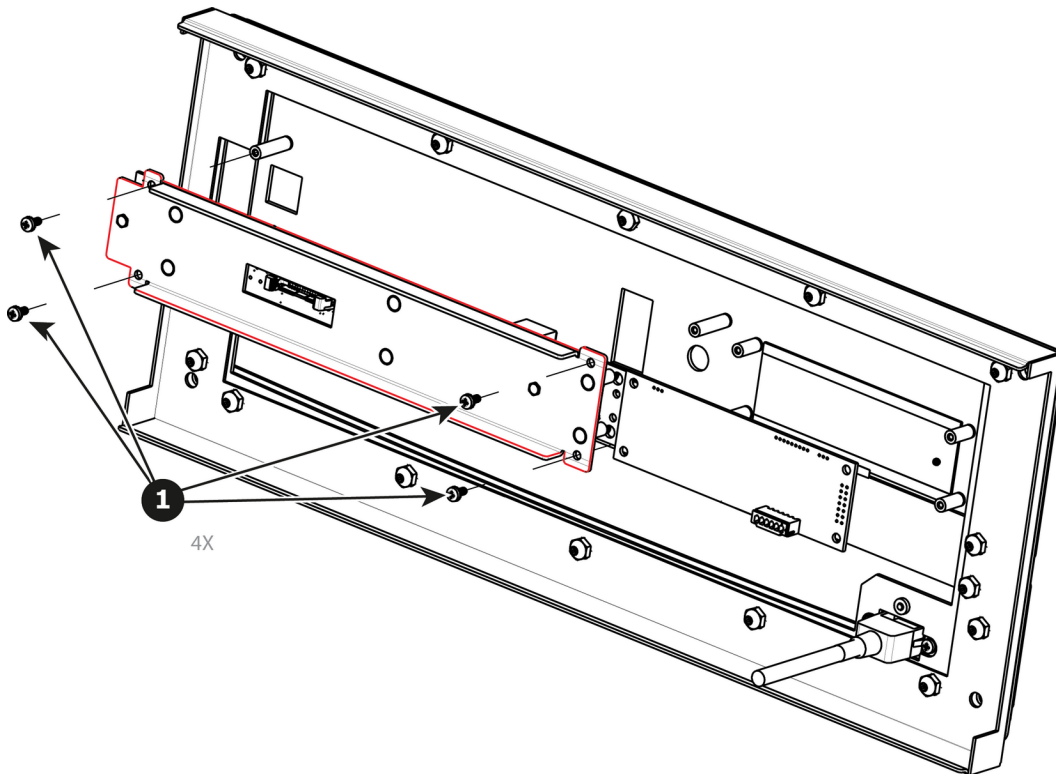

Image 15-23

How to install the Front Panel Mount

To install the Front Panel Mount follow the same procedure in the reverse order.

15.11 Front Panel Board

Flow chart

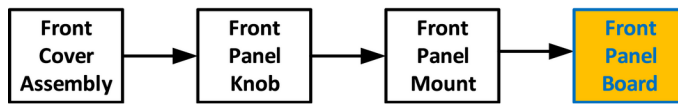

Image 15-24

Concerned parts

R767260K	Front Panel Board
----------	-------------------

Necessary tools

1 x Phillips Screwdriver #2

How to remove the Front Panel Board

1. Remove the two screws (4-40X.25) that secure the PCB to the front mount.

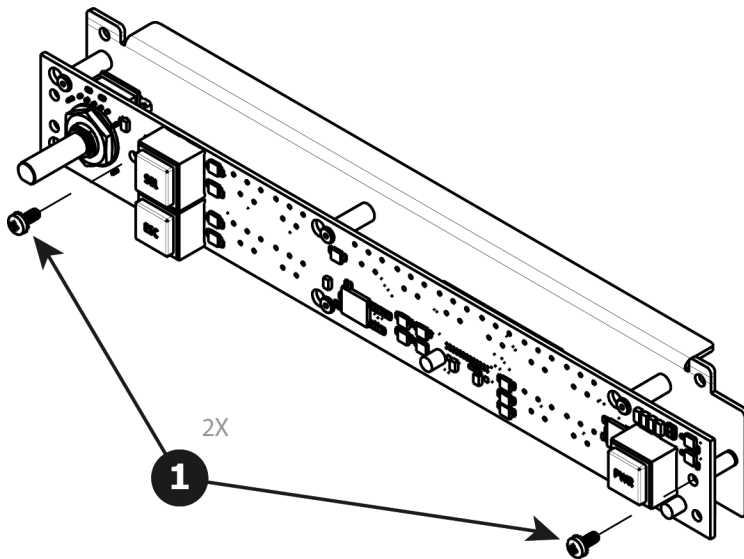

Image 15-25

2. Move the PCB to the right and then out to release it from the mount.

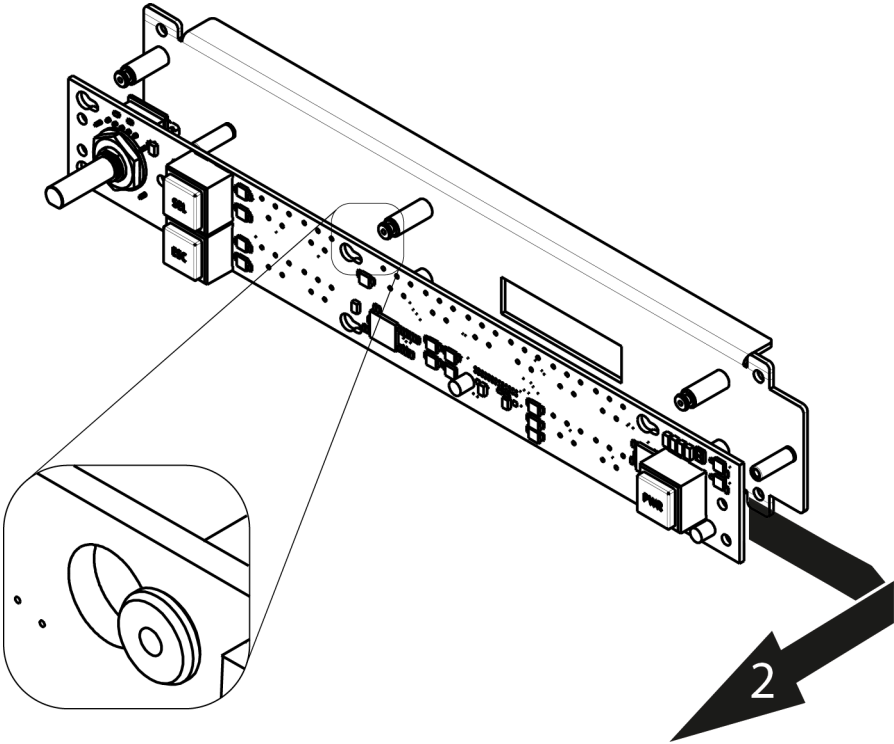

Image 15-26

How to install the Front Panel Board

To install the Front Panel Board follow the same procedure in the reverse order.

15.12 VFD Display Assembly

Flow chart



Image 15-27



Before you proceed removing the VFD Display mount you need to remove the Front Cover Assembly as outlined in the related procedure

Concerned parts

R767241K	VFD Display Assembly
----------	----------------------

Necessary tools

1 x Phillips Screwdriver #2

How to remove the VFD Display Assembly

1. Turn the Front Cover over and remove the four screws (4-40X.25) that secure the VFD display assembly to the front panel mount.

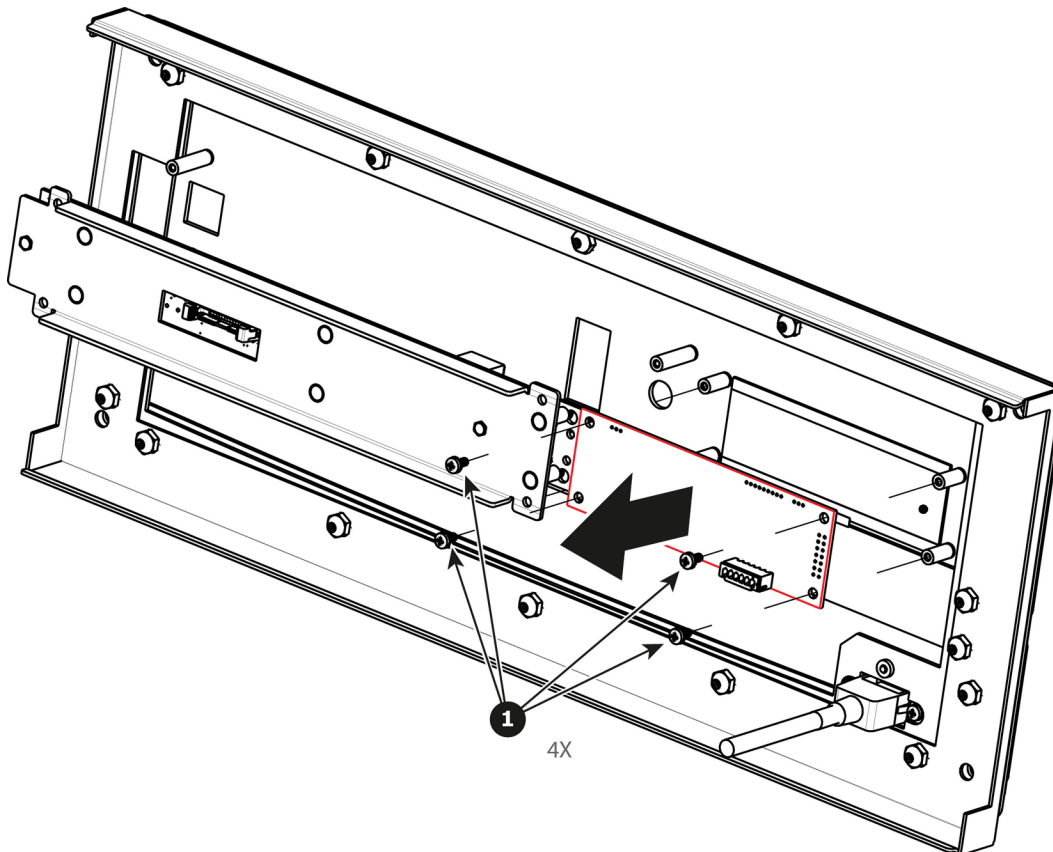

Image 15-28

How to install the VFD Display Assembly

To install the VFD Display Assembly follow the same procedure in the reverse order.

15.13 VFD Display Filter

Flow chart



Image 15-29

Concerned parts

R767246K	VFD Display Filter
----------	--------------------

Necessary tools

None.

How to remove the VFD Display Filter

1. From the front of the unit push hard on the filter until it detaches from the unit.

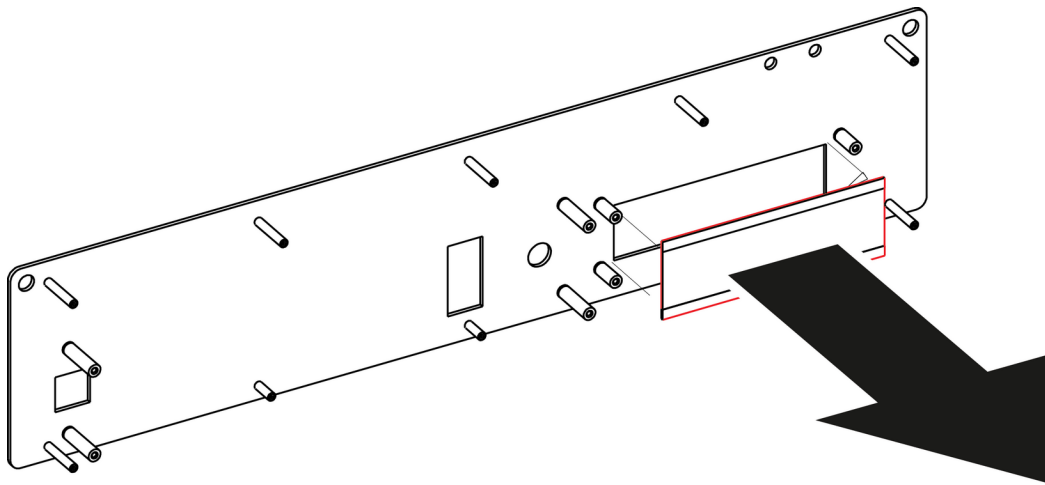

Image 15-30

2. Use alcohol to clean the adhesive residue that held the filter to the metal plate.

How to install the VFD Display Filter

1. Remove the protective film from the front of the filter and release the liner from the tape.
2. Press firmly the filter into the metal plate.

15.14 USB Cable

Flow chart

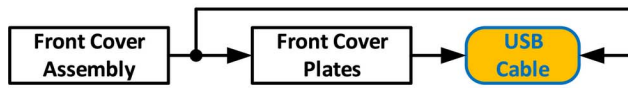

Image 15-31



The USB cable is connected to the USB extension cable (the cable that is connected to the Motherboard). This procedure provides instructions how to disconnect it from both sides of the cable.

Concerned parts

R767283K	Cable Kit Set
----------	---------------

Necessary tools

- 1 x Phillips Screwdriver #2
- Hex Screwdriver
- Nut socket.

How to remove the USB cable

1. Completely detach and pull the Front Cover assembly away from the unit (refer to the related procedure).
2. Disconnect the USB cable from the USB Extension cable (the other side of the cable is connected to the Motherboard).
3. Disconnect the VFD and Front Keyboard Panel cables from the VFD assembly and Front panel boards.
4. Place the Front panel enclosure face down on a flat area.
5. Use the nut socket to remove the 16 nuts (6-32) that attach the first plate to the assembly.
6. Remove and put aside the 16 spacers situated under the plate you just removed.

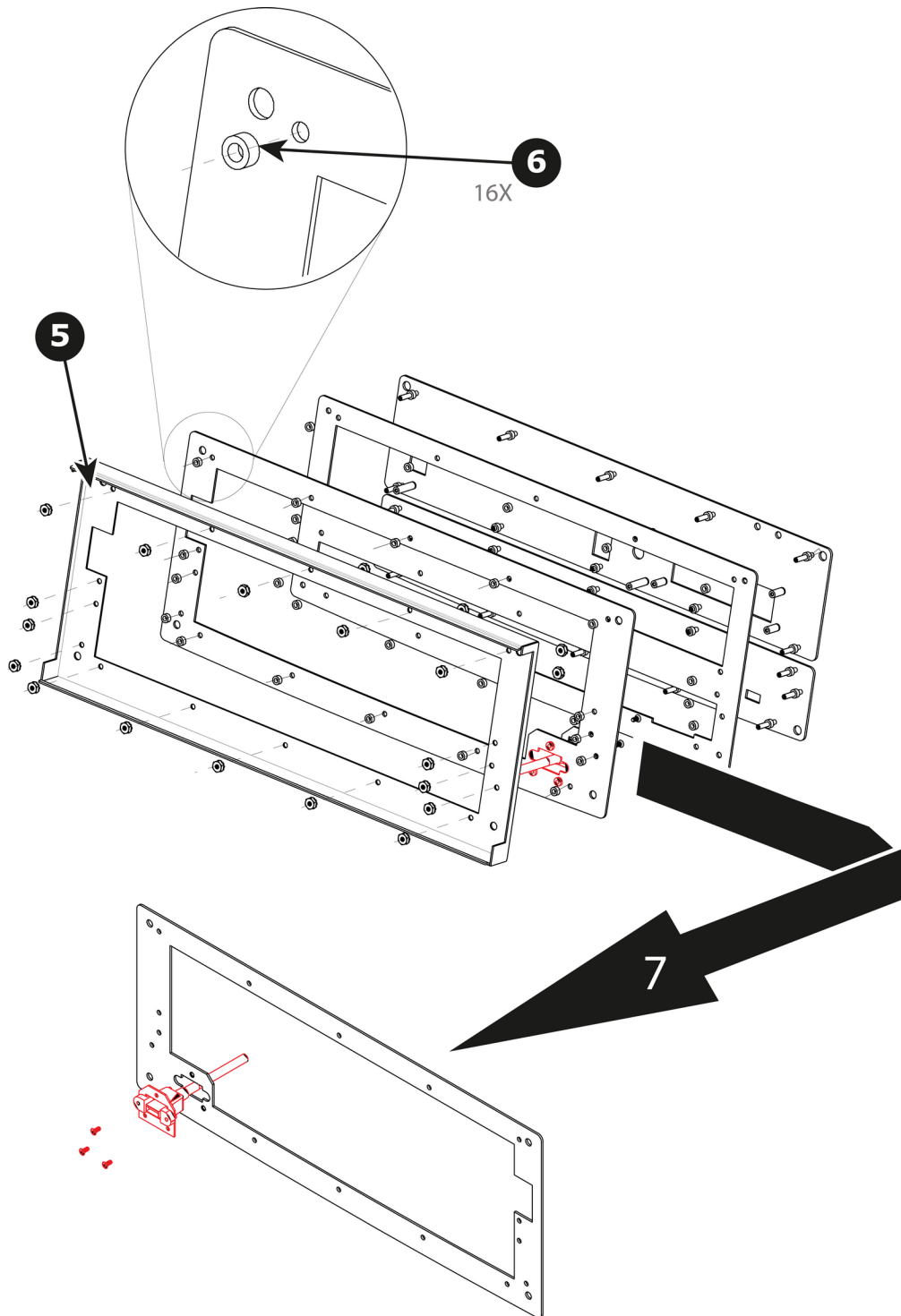

Image 15-32

7. Remove the plate that has been exposed after the nuts are removed.
8. Remove the three screws that hold the USB cable into the metal plate.

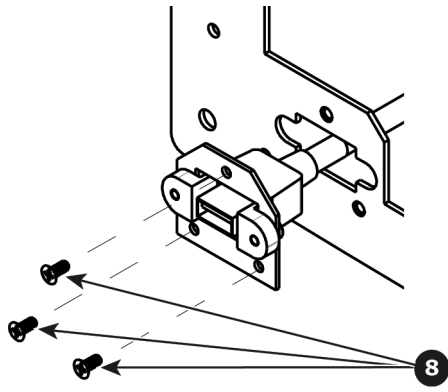

Image 15-33

9. Remove the USB cable.

How to install the USB cable

To install the USB cable follow the same procedure in the reverse order.

15.15 USB Extension Cable

Flow chart

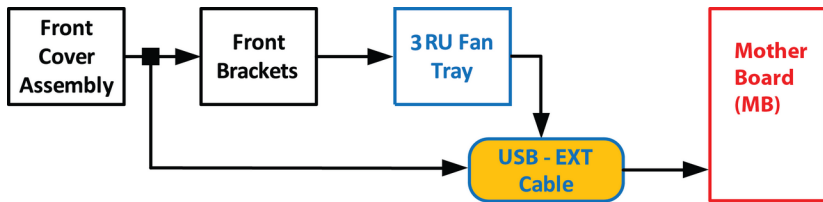

Image 15-34



The USB Extension cable connects the USB cable to the Motherboard. This procedure provides instructions on how to disconnect the cable on both sides.

Overview



Image 15-35
USB Ext Cable connected to the Motherboard

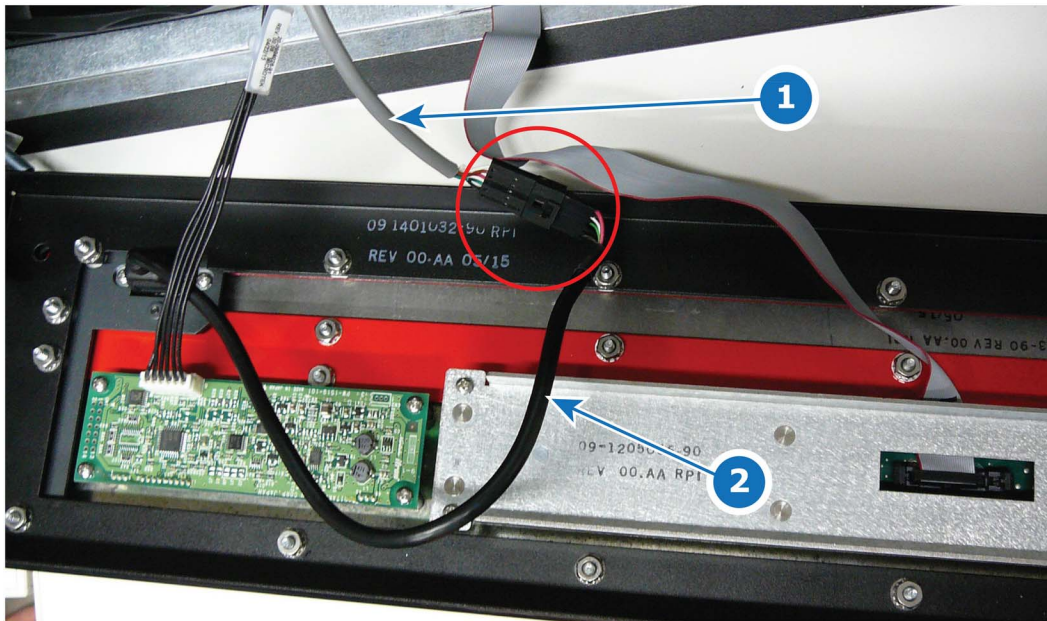

Image 15-36
USB Ext Cable connected to the USB Cable behind the front panel

- 1 USB Ext Cable
- 2 USB Cable

Concerned parts

R767283K	Cable Kit Set
----------	---------------

Necessary tools

1 x Phillips Screwdriver #2 (to remove the front panel assembly)

How to remove the USB Extension cable

- 1. Partially remove the front panel assembly and pull it away to expose the cables behind it (refer to the related procedure).
- 2. Disconnect the USB Extension cable from the USB cable.
- 3. Gently push the cable through the grommet located in the 3RU Fan tray.

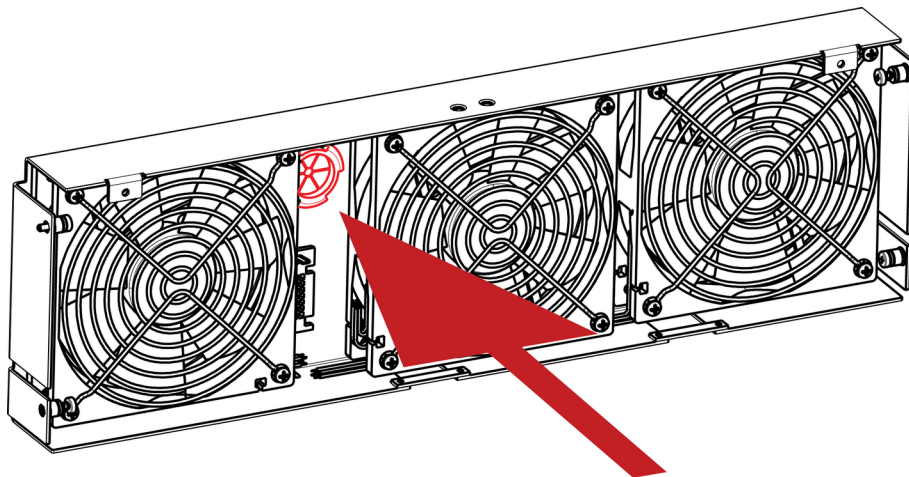

Image 15-37

- 4. Remove the 3RU Fan tray in order to access the motherboard (refer to the related procedure).
- 5. Locate the USB Extension cable that is plugged on the Motherboard.

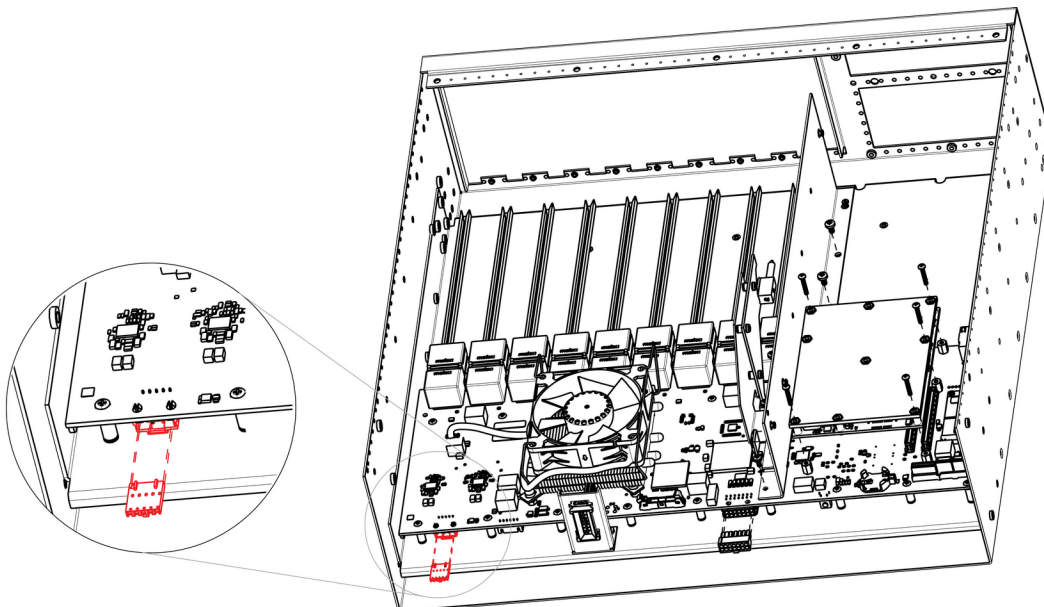

Image 15-38

- 6. Unplug the USB Extension cable by gently pushing it out.
- 7. Pull the cable out of the unit.

How to install the USB Extension cable

To install the USB Extension cable follow the same procedure in the reverse order.

15.16 Power Supply

Concerned parts

R767267K	Power Supply
----------	--------------

Necessary tools

None.

How remove Power Supply

1. Push the latch towards the left.

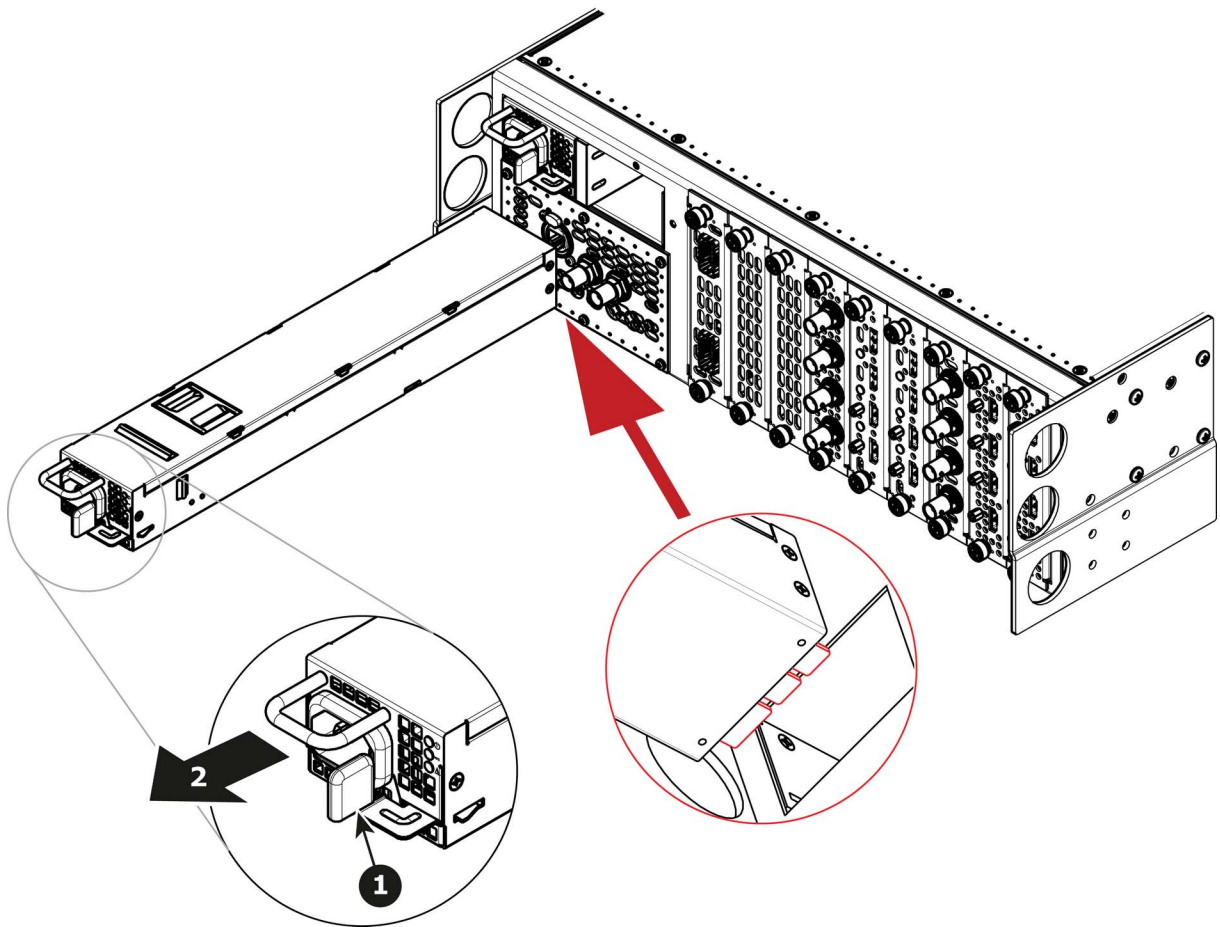

Image 15-39

2. Pull the Power supply out of its slot by pulling on the handle.

How to install Power Supply

1. Insert the Power Supply into the slot.

Note: The card connector (back edge) should be at the bottom of the power supply as shown in the drawing.

2. Push the power supply completely inside the slot. Apply a little pressure by using the handle until the power supply is fully inserted.

15.17 Genlock Assembly

Flow chart



Image 15-40

Overview

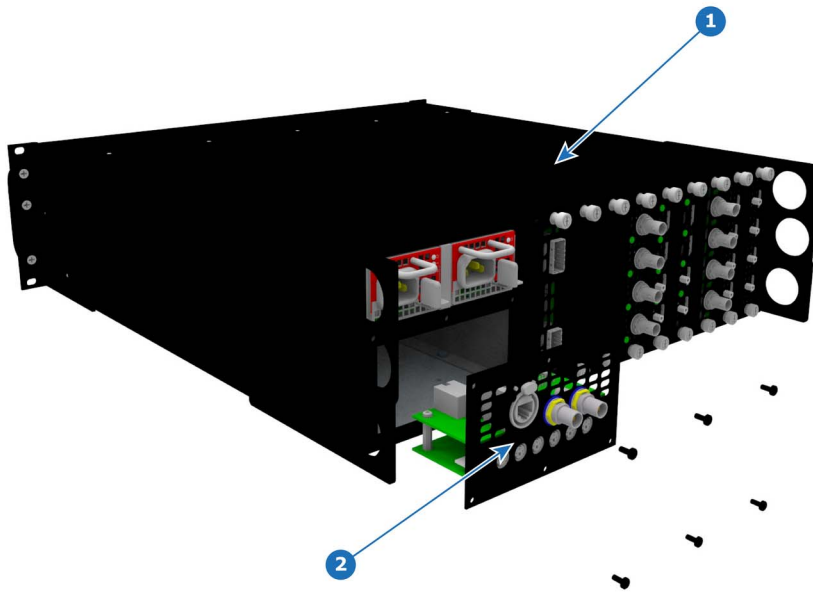

Image 15-41

- 1 Chassis
- 2 Genlock Assembly

Concerned parts

R9004760	GENLOCK/S3D S3
----------	----------------

Necessary tools

- 1 x Phillips Screwdriver #2

How to remove the Genlock Assembly

1. Remove the six pan head screws (4-40 X .25) that attach the Genlock assembly to the rear of the chassis.

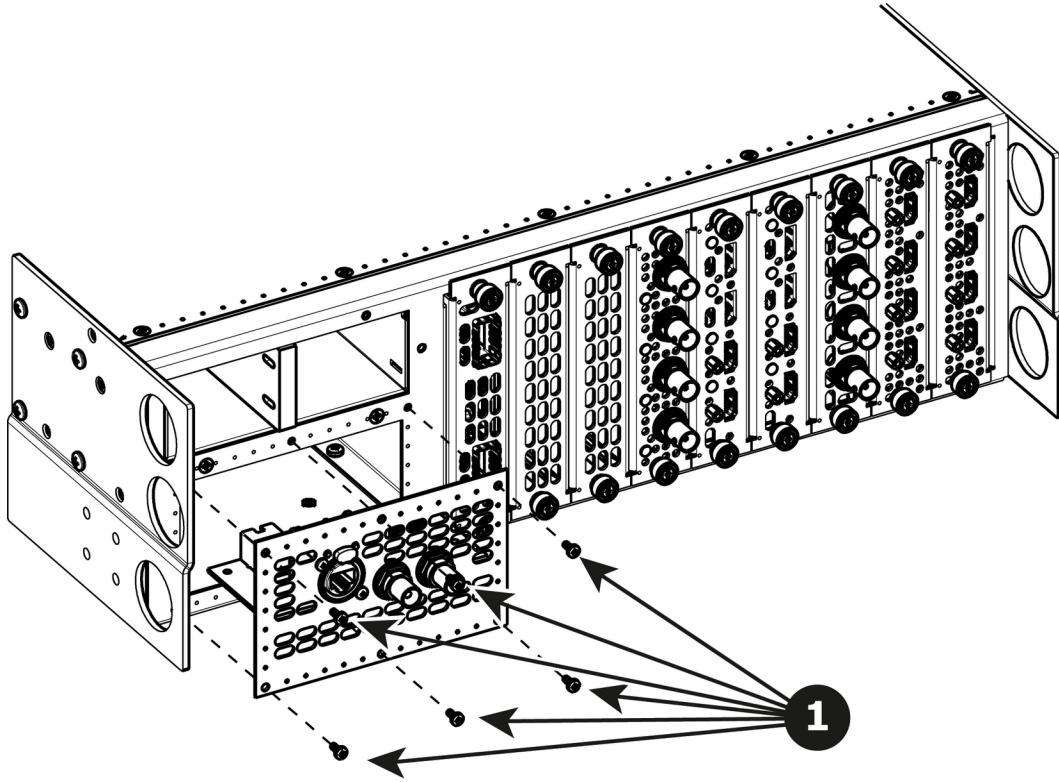

Image 15-42

2. Gently pull the Genlock assembly away from the unit . Don't pull the assembly too far back because there are still 2 cables attached.

Note: At this point there are still 2 cables connecting the Genlock Assembly to the unit.

3. Unlatch the Genlock ribbon cable from the connector and pull it up and away from the Genlock board.

Note: This cable connects the Genlock board to the Motherboard.

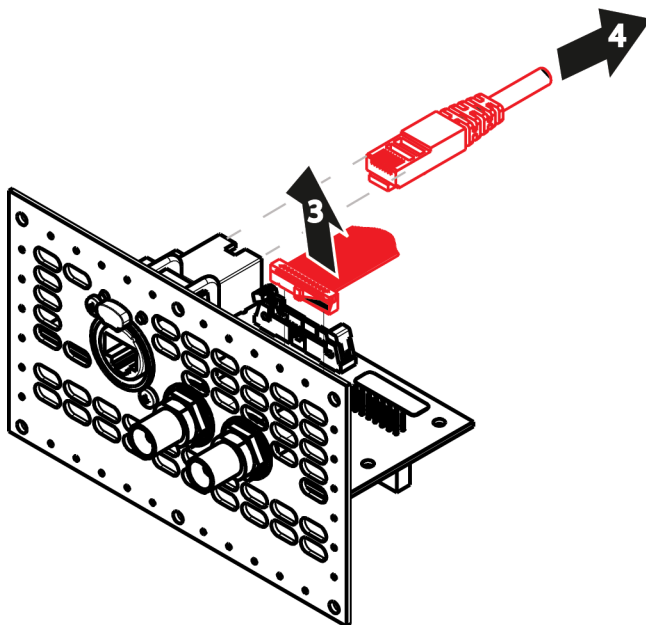

Image 15-43

4. Unlatch the Ethernet cable from the connector and pull back and away from the Genlock board.

Note: This cable connects the Genlock board to the Motherboard.

How to install the Genlock Assembly

To install the Genlock Assembly follow the same procedure in the reverse order.

15.18 Rear Rack Ears

Concerned parts

R767282K	Rear Connector protector
----------	--------------------------

Necessary tools

1 x Phillips Screwdriver #2

How to remove Rear Rack-Ears

1. Remove the eight pan head screws (8-32x.31), four from each side, to detach the rear rack ears and connector protectors from the unit.

Note: You don't need to remove the rear rack ears to access any other part of the unit.

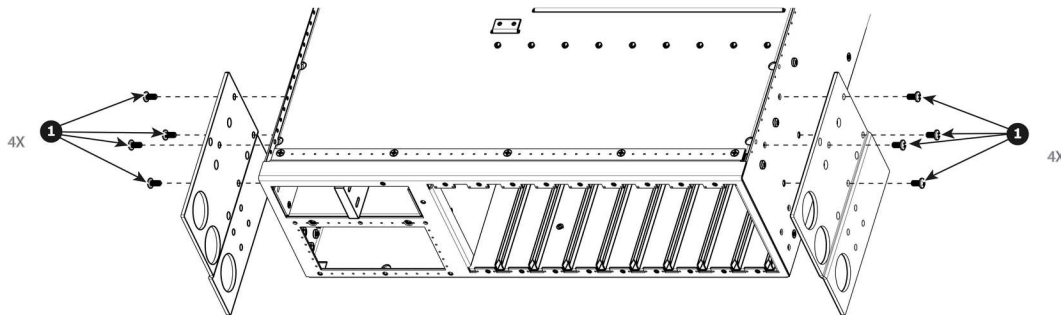

Image 15-44

How to install Rear Rack-Ears

To install the Rear Rack-Ears follow the same procedure in the reverse order.

15.19 Front Rack-Ears

Flow chart

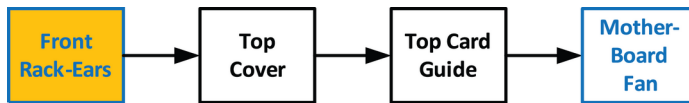

Image 15-45

Concerned parts

R767281K	FRONT RACK EARS S3
----------	--------------------

Necessary tools

1 x Phillips Screwdriver #2

How to remove Side Rack-Ears

1. Loosening and removing the six (three on each side) pan head screws that secure the Rack Ears to the chassis sides.

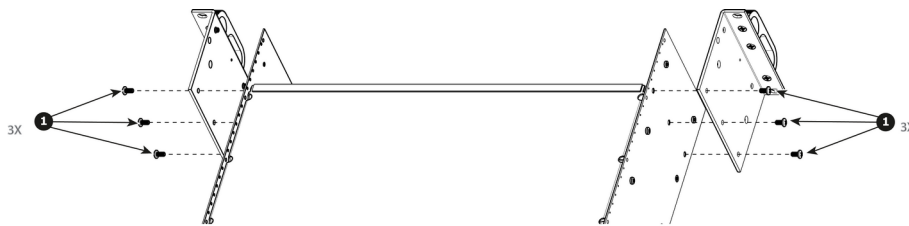

Image 15-46

2. Remove the Rack Ears from the Chassis.

Note: *If the front face and the front brackets were not removed before this step, the entire of these elements will be automatically detached from the chassis when you remove the Front Rack Ears. The front brackets are fixed on the Front Rack Ears, not on the chassis.*

How to install Side Rack-Ears

To install the Side Rack-Ears follow the same procedure in the reverse order.

15.20 Top Cover

Flow chart

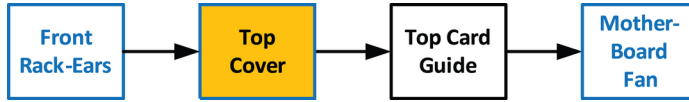

Image 15-47

Necessary tools

1 x Phillips Screwdriver #2

How to remove Top Cover

1. Remove the 12 screws from the two sides (6 in each side, 4-40x0.25) that are located towards the top side of the unit.

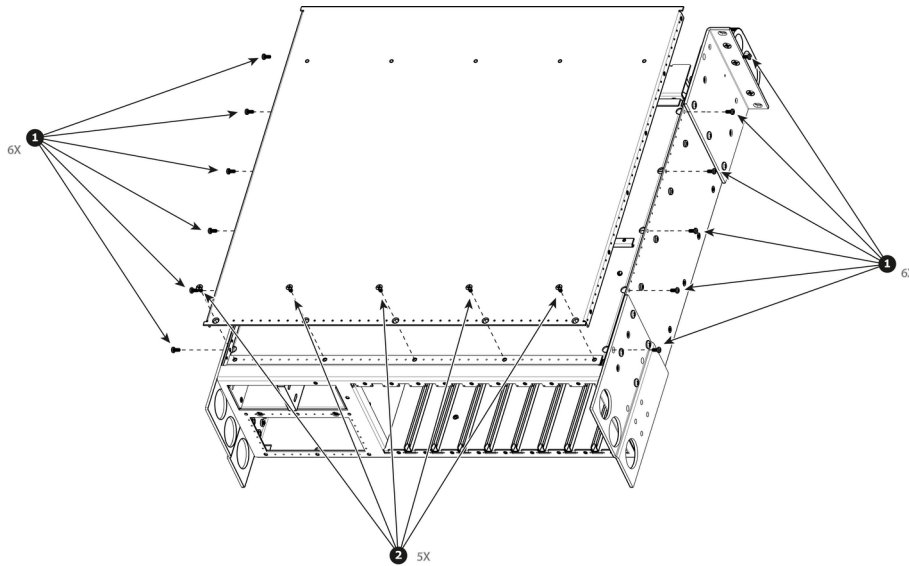

Image 15-48

2. Remove the 5 screws (6-32x0.25) located on the top at the back of the chassis.
3. Remove the cover by gently pulling it away from the unit.

How to install Top Cover

To install the Top Cover follow the same procedure in the reverse order.

15.21 Top Card Guide

Flow chart

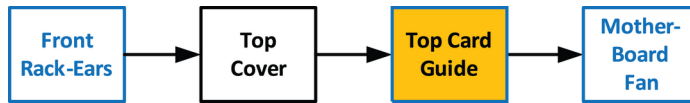

Image 15-49

Necessary tools

1 x Phillips Screwdriver #2

How to remove Top Card Guide

1. Remove the 12 screws from the two sides (6 in each side, 6-32x0.25) that are located towards the bottom of the unit.

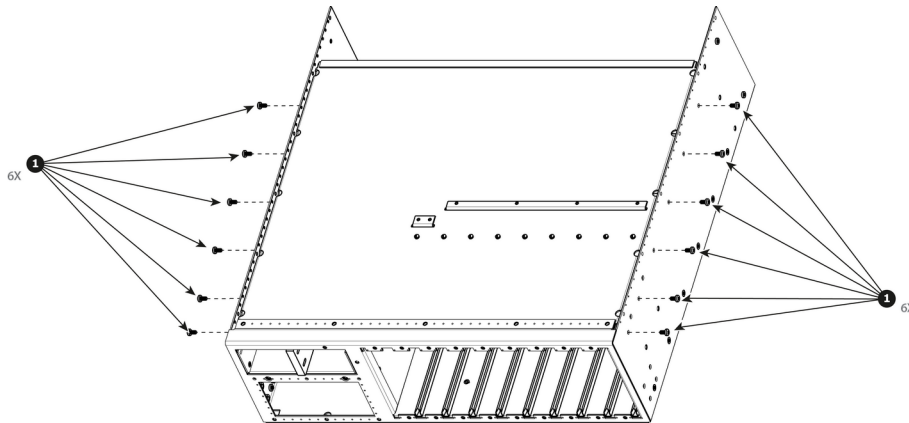

Image 15-50

2. Remove the card guide cover by gently pulling it away from the unit.

How to install Top Card Guide

To install the Top Card Guide follow the same procedure in the reverse order.



When installing the guide make sure you have 2 cards from the rear installed before tightening the screws.



Use Loctite 242 to the screws before installing.

15.22 Motherboard Fan

Flow chart

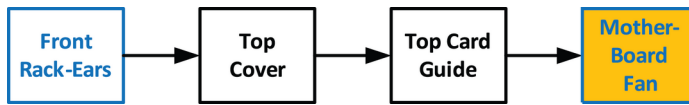

Image 15-51

Overview

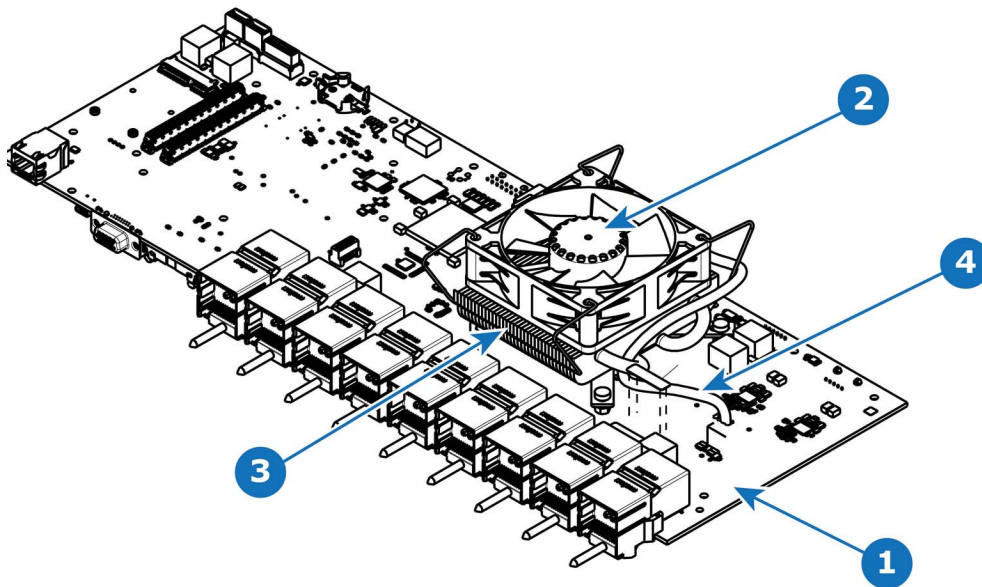

Image 15-52

- 1 Motherboard
- 2 Fan
- 3 Heatsink
- 4 Fan power cable

Concerned parts

R767265K	Motherboard Heatsink & Fan kit
----------	--------------------------------

Necessary tools

- 1 x Phillips Screwdriver #2

How to remove Motherboard Fan

1. Remove the cable that provides power to the heatsink fan.
2. Lift the two handles to release the fan from the heatsink.

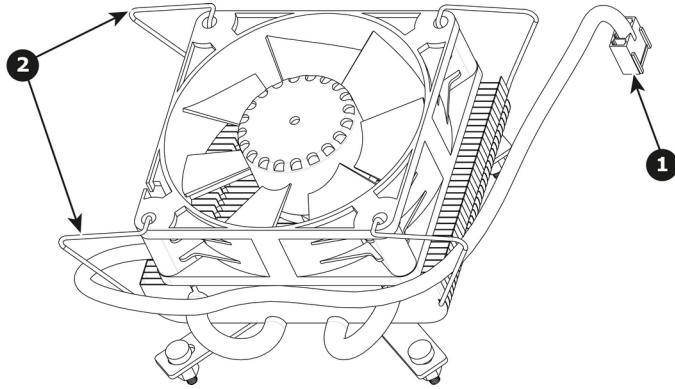

Image 15-53

3. Lift the fan away from the heatsink.

How to install Motherboard Fan

1. Remove the fan from the Heatsink/Fan spare kit.
2. Using the clips install the fan on the top of the heatsink that is on the motherboard.
3. Connect the fan power cable to header xxx located on the motherboard.



Disregard the heatsink from the spare kit.

15.23 Power Interposer Assembly

Flow chart

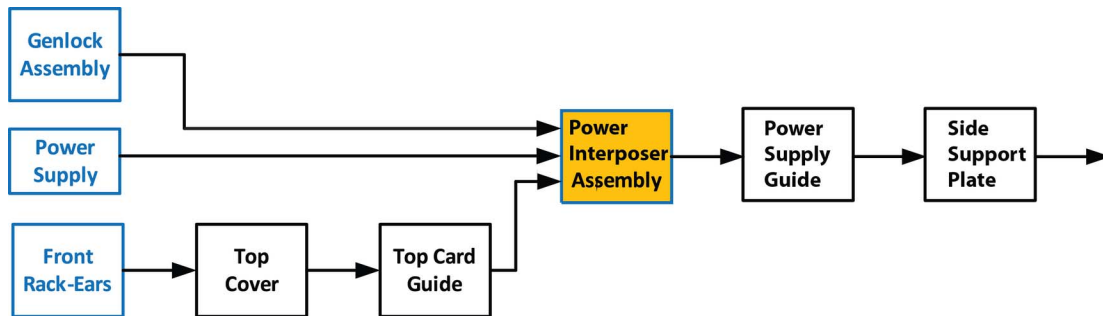

Image 15-54

Overview

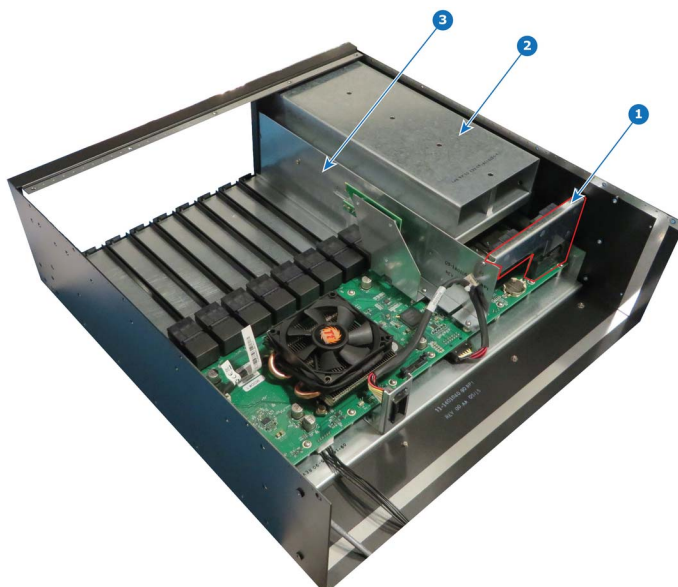

Image 15-55

- 1 Power Interposer
- 2 Power supply guide
- 3 Side Support Plate

Concerned parts

R767279K	POWER INTERPOSER ASSEMBLY
----------	---------------------------

Necessary tools

- 1 x Phillips Screwdriver #2

How to remove Power Interposer Assembly

1. Remove the pan head screw (4-40x0.25 — black) that attach the Power Interposer Assembly to the side of the chassis.
2. Remove the pan head screw (4-40x0.25 — Stainless steel) that attach the Power Interposer Assembly to the side of the side support plate.
3. Gently pull the Power Interposer Assembly away from the unit.

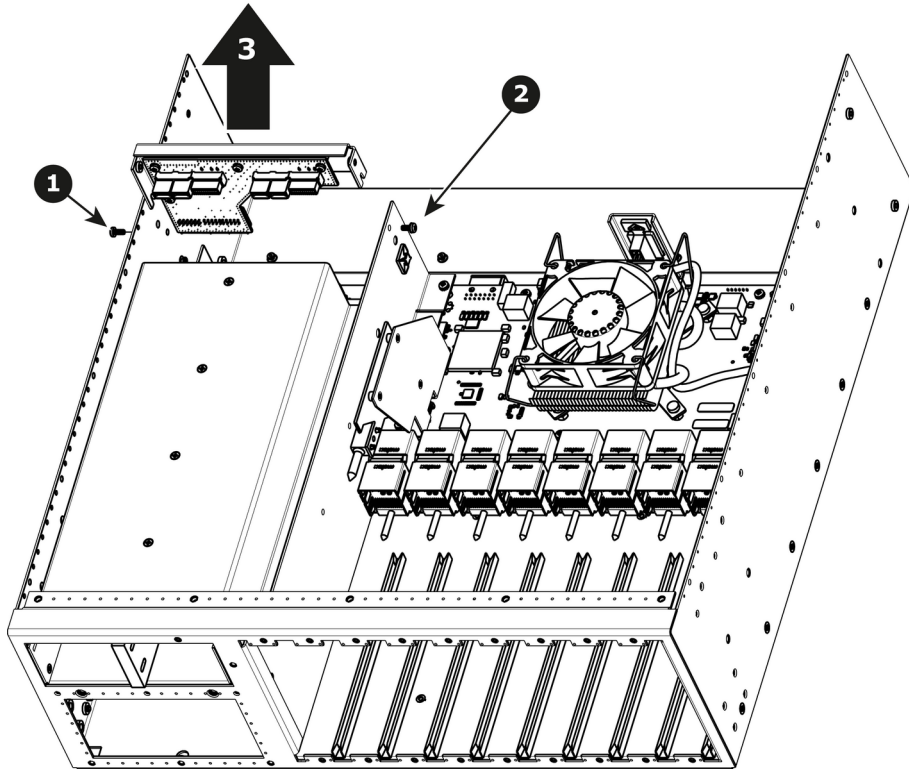

Image 15-56

How to install Power Interposer Assembly

1. Install the Power Interposer Assembly and guide onto keyhole features in the sheet metal.

Note: Push the Power Interposer Assembly completely inside the connector onto the motherboard. Apply a little pressure until it is fully inserted.

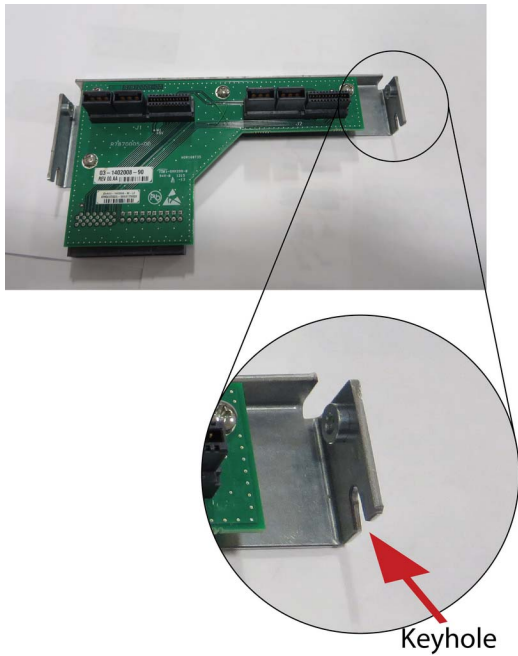

Image 15-57

2. Install the two screws.

15.24 Power Supply Guide

Flow chart

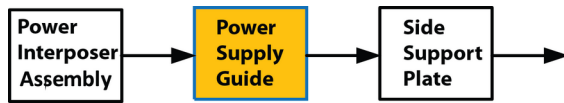

Image 15-58



Actually to remove the power supply guide, you must move the entire motherboard mount forward. The reason for this is there is not enough space to get the power supply guide out without moving everything towards the front of the chassis.

Overview

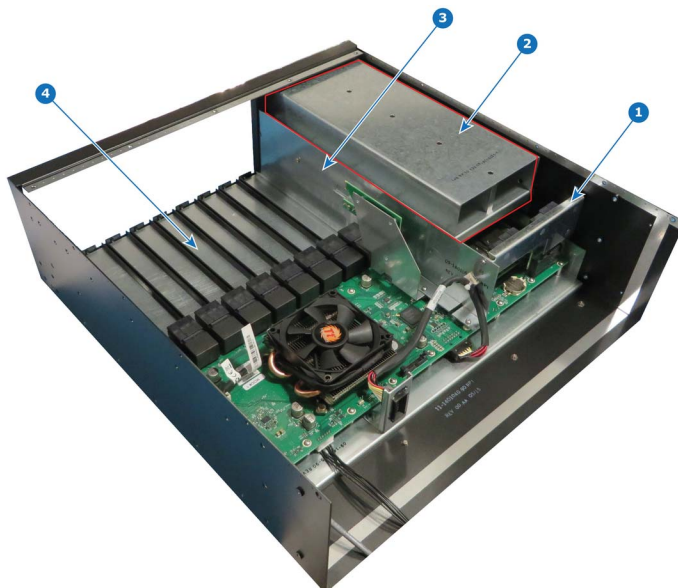

Image 15-59

- 1 Power Interposer
- 2 Power supply guide
- 3 Side Support Plate
- 4 Motherboard Mount

Necessary tools

- 1 x Phillips Screwdriver #2



To remove the power supply guide, the entire Motherboard Mount must be move forward.

How to remove Power Supply Guide

1. Turn the unit over to remove the nine flat head screws (4-40x0.25 — black) that attach the Motherboard Mount to the bottom of the chassis.

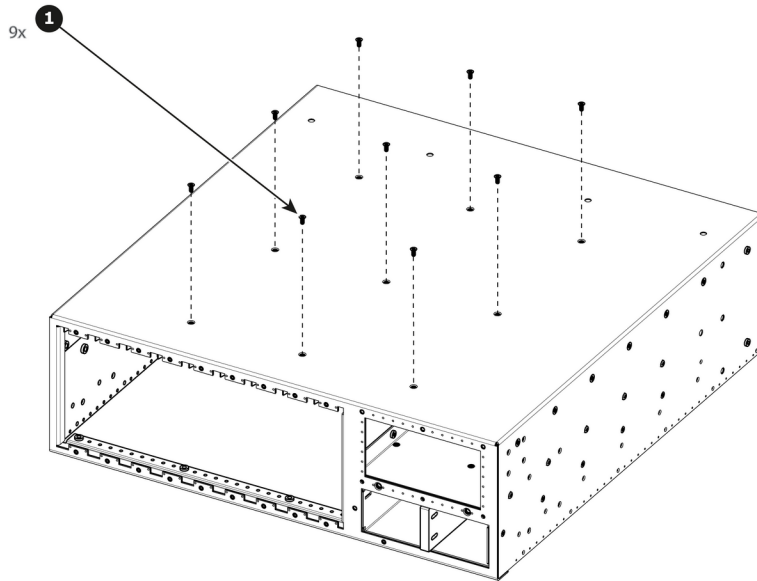

Image 15-60

2. Remove the five pan head screws (4-40x0.25 — black) that attach the Power supply guide to the side of the chassis.
3. Remove the twelve flat head screws (6-32x0.25 — black) that attach the Motherboard Mount to the side of the chassis.
4. Remove the five flat head screws (4-40x0.25 — black) that attach the Motherboard Mount to the side of the chassis.

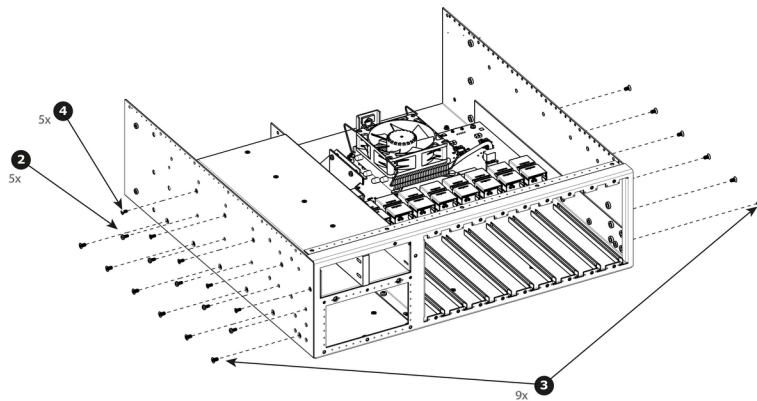

Image 15-61

5. Remove the three pan head screws (4-40x0.25 — Stainless steel) that attach the Power Supply Guide to the side of the side support plate.

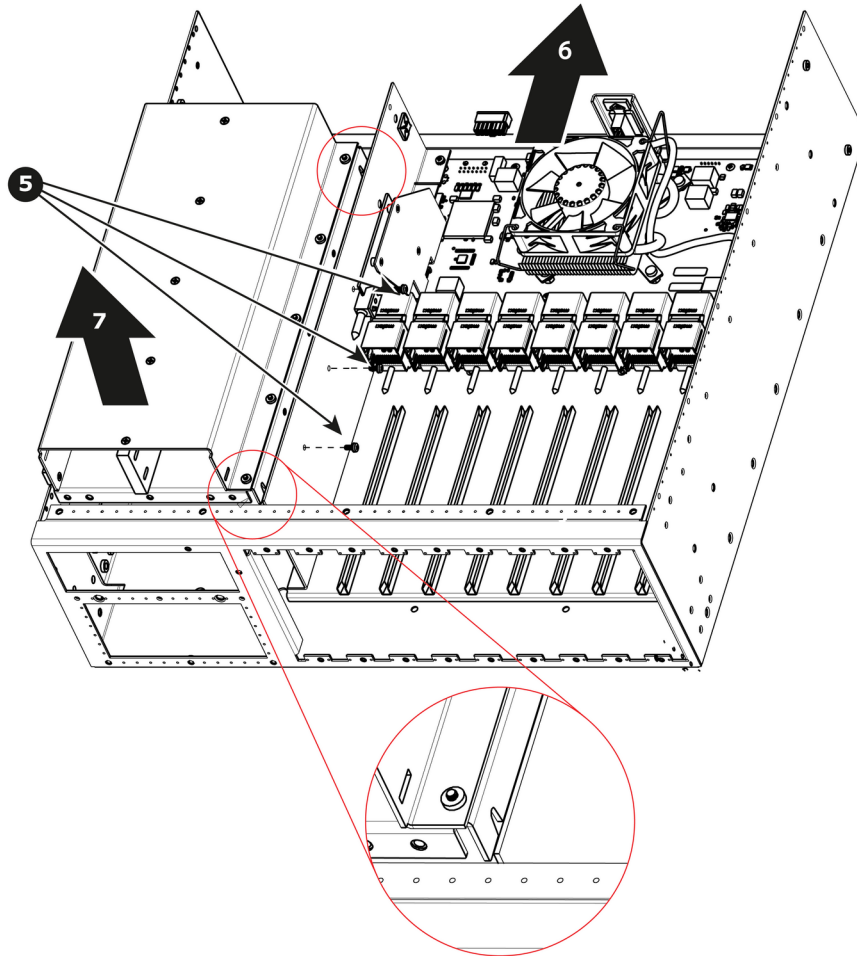

Image 15-62

- 6. Move the entire motherboard mount forward
- 7. Gently pull the Power Supply Guide away from the unit.

How to install Power Supply Guide

To install the Power Supply Guide follow the same procedure in the reverse order.



There are slots cut into the bottom which will make installation of the guide much easier. See detail on the previous drawing.

15.25 Side support plate

Flow chart

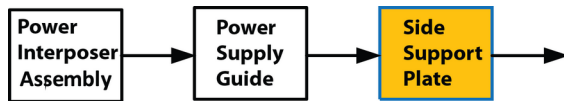

Image 15-63

Overview

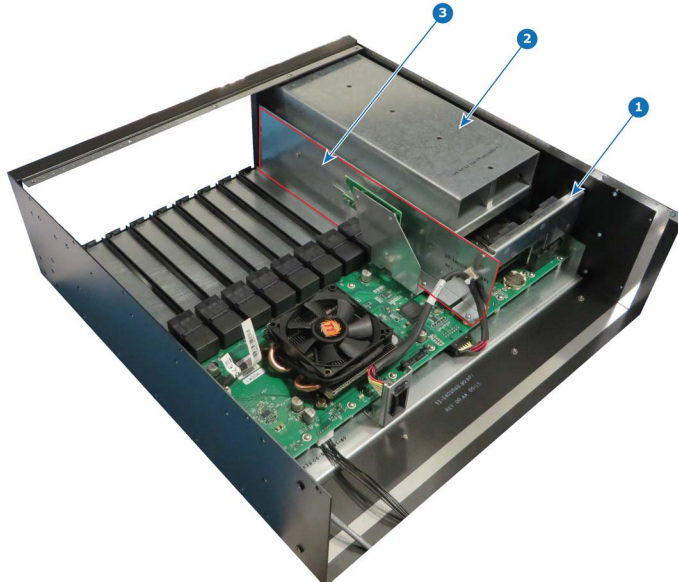

Image 15-64

- 1 Power Interposer
- 2 Power supply guide
- 3 Side Support Plate

Necessary tools

1 x Phillips Screwdriver #2

How to remove Side Support Plate

1. Remove the two pan head SEMS screws (6-32x0.25 — Stainless steel) that attach the Side Support Plate to the Motherboard Mount.
2. Remove the three pan head SEMS screws (4-40x0.25 — Stainless steel) that attach the Side Support Plate to the Motherboard Mount.
3. Move forward the Side Support Plate (this item is align with the Motherboard Mount via key holes), and gently pull the Side Support Plate away from the unit.

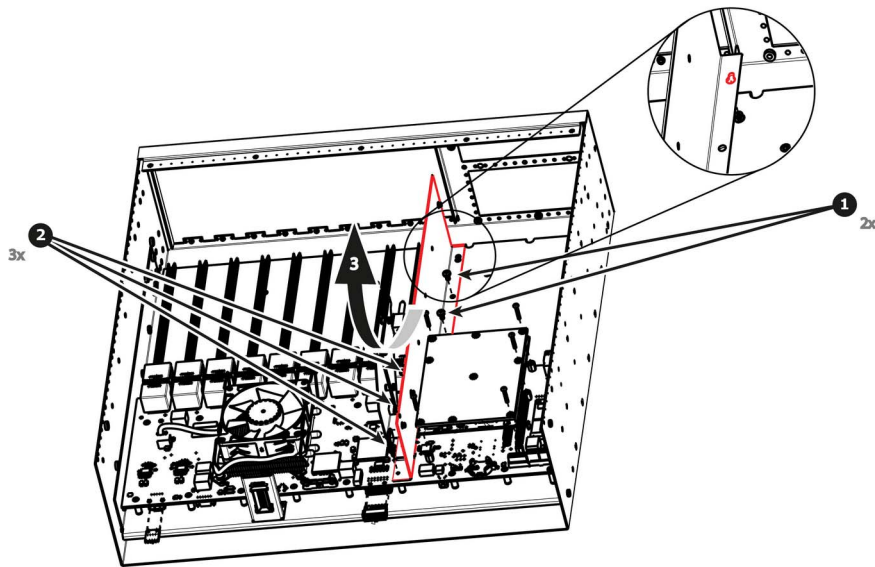

Image 15-65

Note: It could be necessary to release the cable tie that maintain the fan power cable in place.

How to install Side Support Plate

To install the Side Support Plate follow the same procedure in the reverse order.



There are key holes cut into the bottom of the Side Support Plate which will make installation much easier. See detail on the previous drawing.

15.26 Link Card Interposer

Flow chart

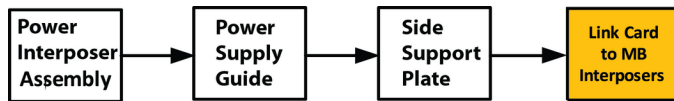

Image 15-66

Overview

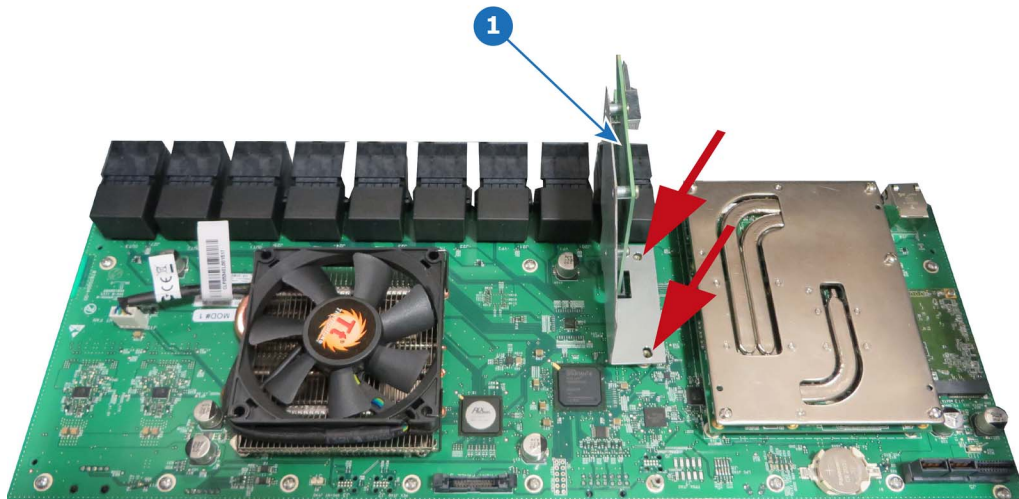

Image 15-67

1 Link Card Interposer

Necessary tools

none

How to remove Link Card Interposer

1. Remove the Link Card Interposer from the unit.

Note: The screws that fix the Link Card Interposer were already removed during the Side Support Plate removing stage.

How to install Link Card Interposer

1. Install the Link Card Interposer into the unit.

Note: The Link Card Interposer will be fixed during the Side Support Plate fixing stage.

15.27 CPU Module

Flow chart

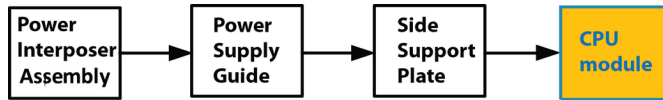

Image 15-68

Overview

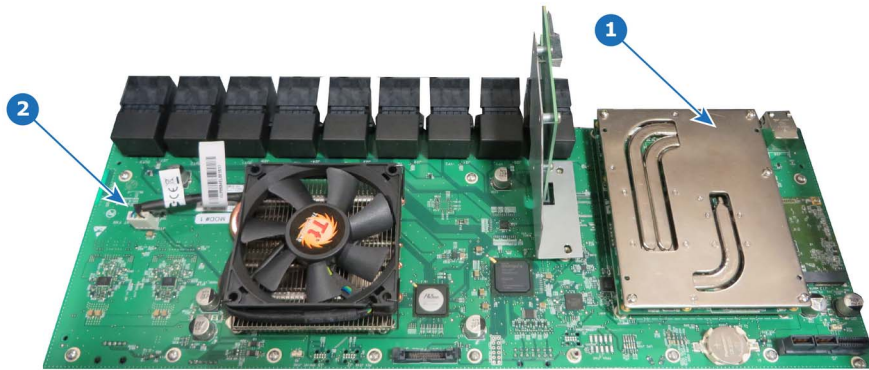

Image 15-69

- 1 CPU module
- 2 Motherboard

Concerned parts

R767264K	CPU module
----------	------------

Necessary tools

- 1 x Phillips Screwdriver #2

How to remove CPU Module

1. Remove the five screws that attach CPU module to the system card.
2. Carefully remove the CPU module by lifting it up.

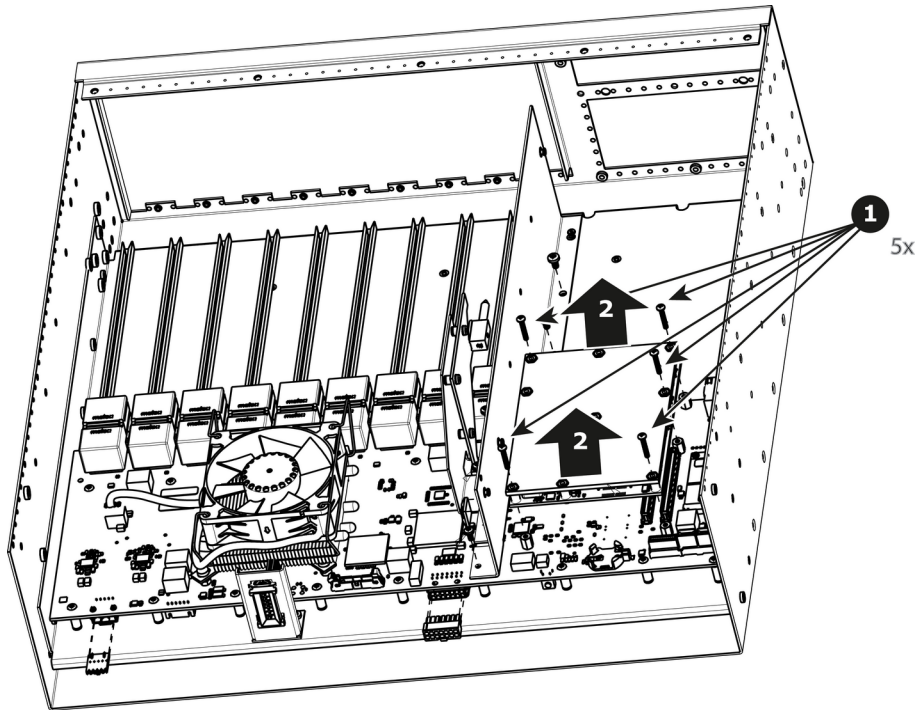

Image 15-70

How to install the CPU module

To install the CPU module follow the same procedure in the reverse order.



Install the CPU Module by rocking left and right while applying pressure on the connectors.

15.28 Solid-State Memory

Flow chart

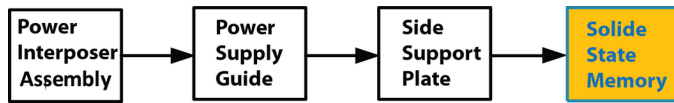

Image 15-71

Overview

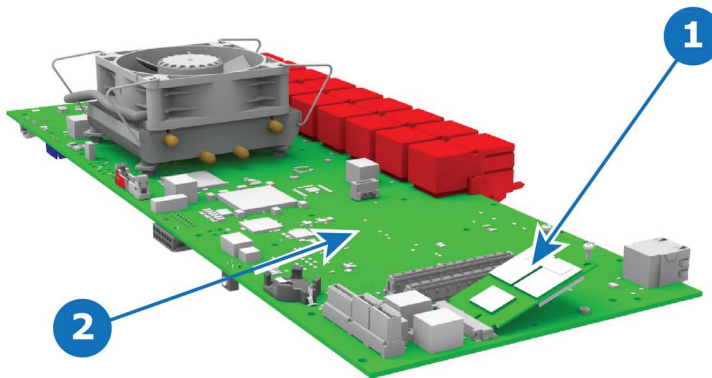

Image 15-72

- 1 Solid State Memory card
- 2 MotherBoard

Concerned parts

R767275K	Solid State Memory
----------	--------------------

Necessary tools

- 1 x Phillips Screwdriver #2

How to remove the Solid State Memory

1. Remove the 2 screws that hold the memory card.
2. Carefully remove the memory card from the socket.

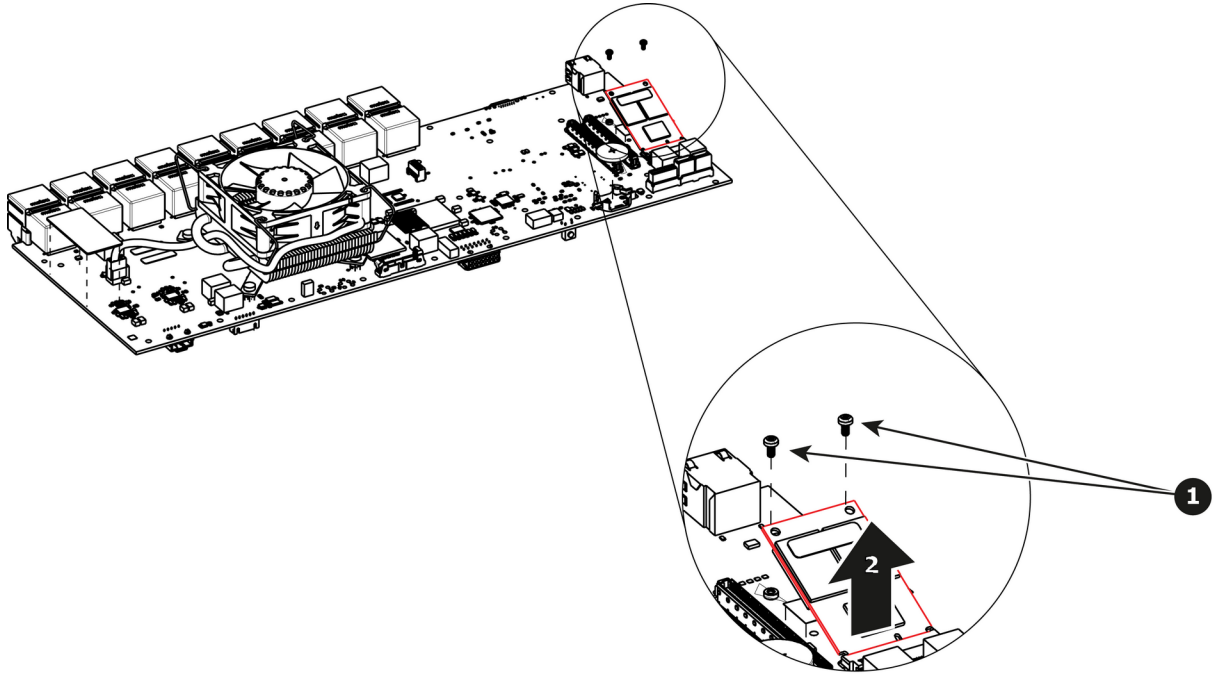

Image 15-73

How to install the Solid State Memory

To install the Solid State Memory follow the same procedure in the reverse order.

15.29 System Battery

Flow chart

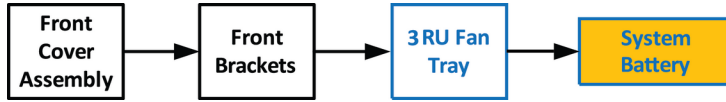

Image 15-74

Overview

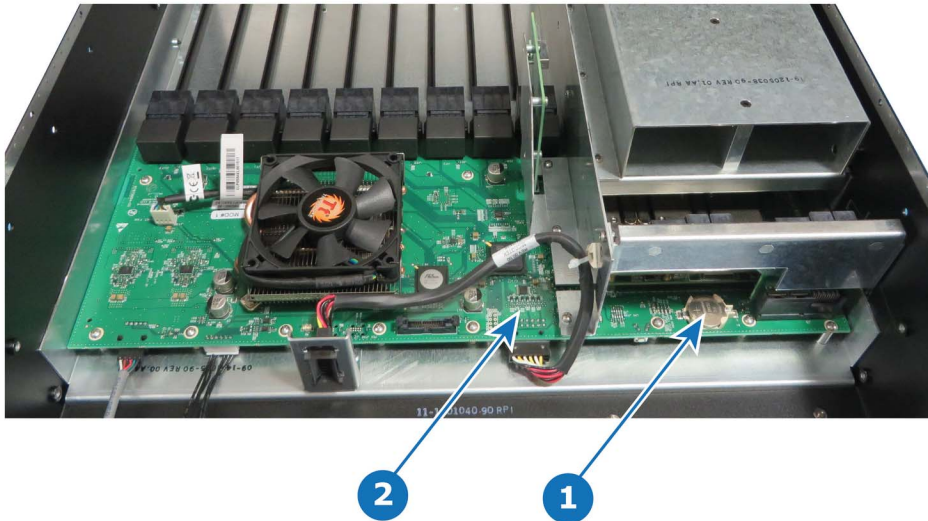

Image 15-75

Concerned parts

V327007	Battery
---------	---------

Necessary tools

None.

How to remove the System battery

1. Carefully remove the battery from its socket.

How to install the System battery

To install the System battery follow the same procedure in the reverse order.



When a new battery is installed, the user need to place a sticker on the motherboard mount that indicates when the battery was last replaced. The absence of sticker means the battery has never been replaced. In this case the S/N sticker can be used for the reference date.

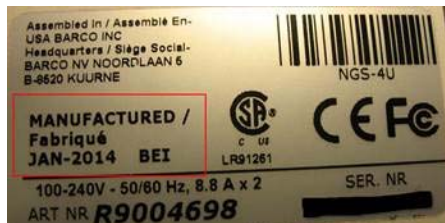

Image 15-76

e.g. E2 S/N sticker — Manufacturing date

15.30 VFD Cable

Flow chart

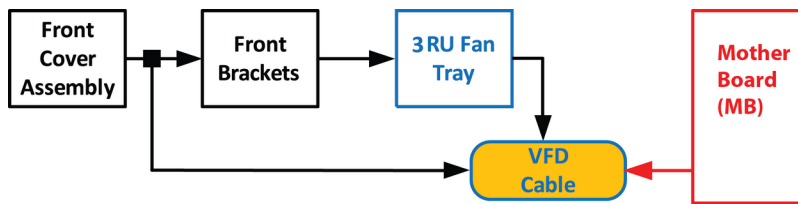

Image 15-77



The flat ribbon VFD cable connects the VFD assembly (front face) to the Motherboard.



One end of the flat ribbon VFD cable is clamped between the Motherboard and the Motherboard mount. Remove this cable requires to separate these parts.

Concerned parts

R767283K	S3 Cable Kit Set
----------	------------------

Necessary tools

- 1 x Phillips Screwdriver #2
- Hex Screwdriver

How to remove the VFD Cable

1. Remove the front panel assembly and pull it away to expose the cables behind it (refer to the related procedure).
2. Push out the side latches on VFD connector to release the VFD cable.

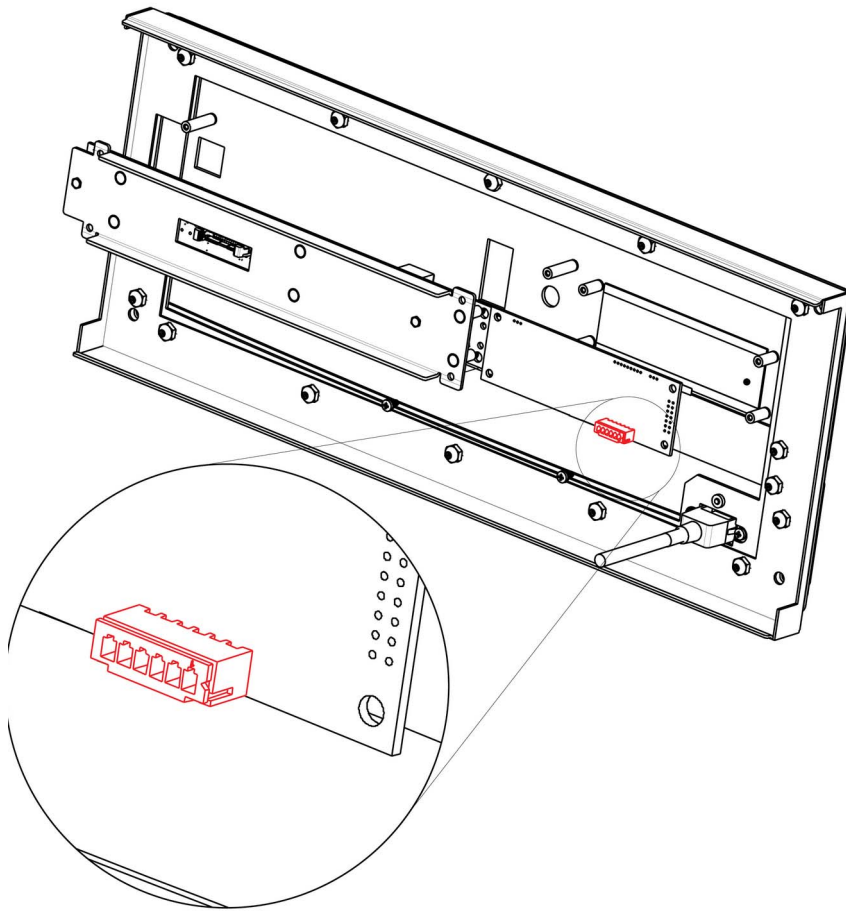

Image 15-78

3. Remove the front bracket and the 3RU Fan tray in order to access inside of the unit (refer to the related procedures).
4. Gently push the cable through the grommet located in the 3RU Fan tray.

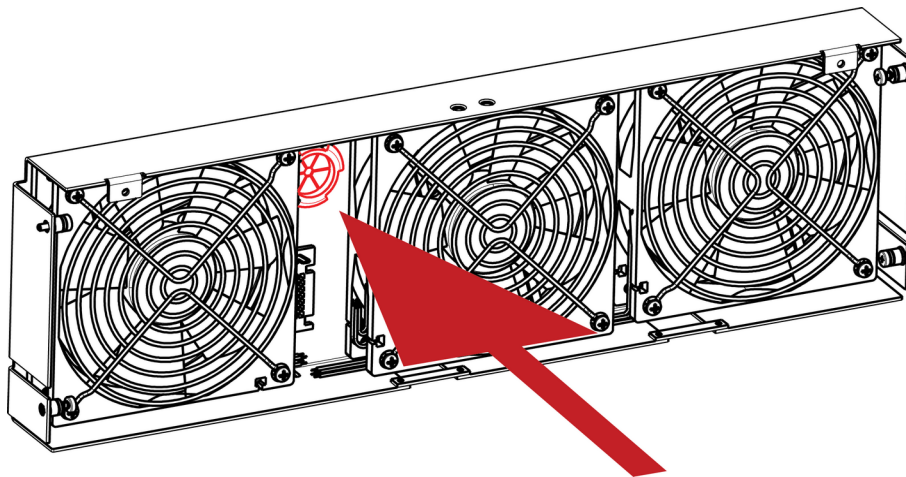

Image 15-79

Note: From this step, only the other end of the VFD cable stays connected to the motherboard. Unfortunately it is necessary to remove the motherboard from the motherboard mount to unplug it. (refer to the "Process Overview", page 452).

5. Remove the following parts to access the motherboard :

- Rear cards (VPU, Link, I/O)
- CPU module.
- Link card interposer.

Note: Refer to the related procedures to remove these parts. Remove these parts requires removing lot of parts from the unit (Power supply, Power interposer, Power supply guide, Side Support Plate ...)

Note: It is not necessary to remove the solid state memory, the system battery and the other cables to give access to the motherboard fixing screws.

6. Remove the Motherboard from the Motherboard mount.
 - a) Remove the three m/f standoffs (4-40 X 3/16" .25") that attach the Motherboard to the Motherboard mount.
 - b) Remove the five m/f standoffs (m2.5 X 8mm) that attach the Motherboard to the Motherboard mount.
 - c) Remove the sixteen long pan head SEMS screws (4-40x.31" — SEMS refers to an integrate lock washer) that attach the Motherboard to the Motherboard mount.

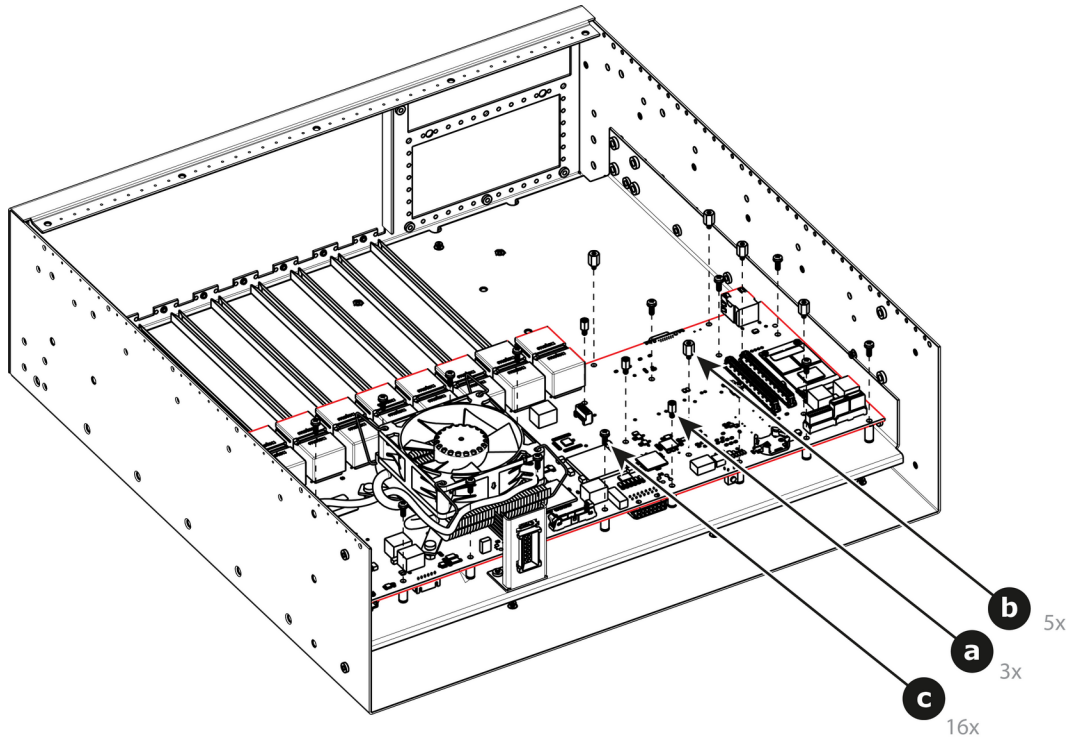

Image 15-80

7. Locate the VFD cable that is plugged on the Motherboard.

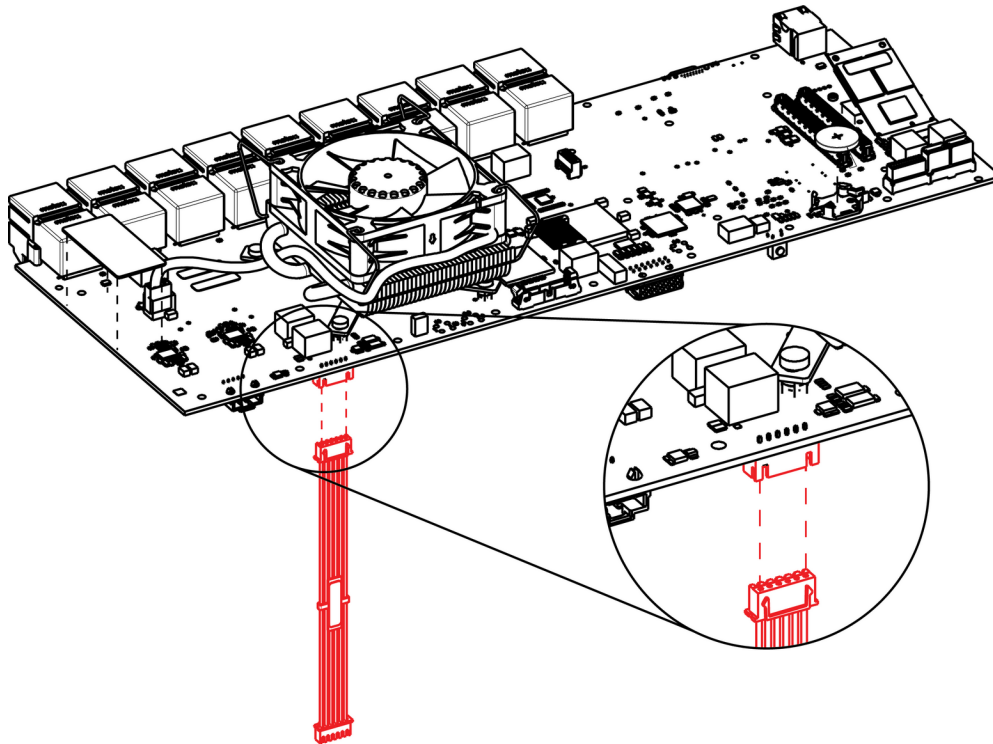

Image 15-81

8. Unplug the VFD cable.
9. Pull the cable out of the unit .

How to install the VFD Cable

To install the VFD Cable follow the same procedure in the reverse order.

15.31 Keyboard Cable

Flow chart

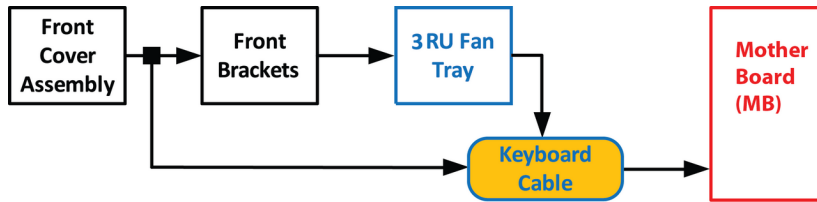

Image 15-82



The flat ribbon keyboard cable connects the Front panel board to the Motherboard. This procedure provides instructions on how to disconnect the cable on both sides.

Overview

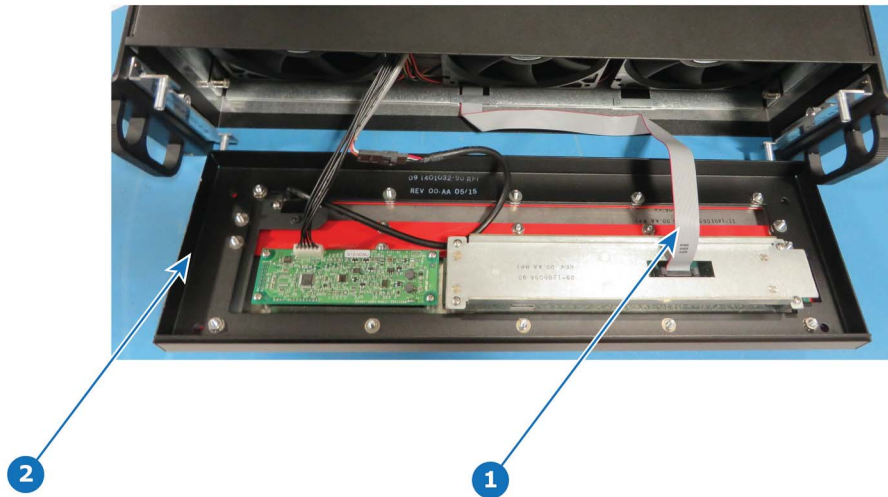

Image 15-83
 1 Keyboard cable
 2 Front face

Concerned parts

R767283K	S3 Cable Kit Set
----------	------------------

Necessary tools

- 1 x Phillips Screwdriver #2
- Hex Screwdriver

How to remove the Keyboard cable

1. In order to access the motherboard, follow the steps detailed in the other procedures to remove the Front Cover Assembly, Front brackets and 3RU Fan Tray. Make sure that the Keyboard Cable is disconnected from the Front Panel board.
2. Locate the keyboard connector and push the latches out to release the cable.

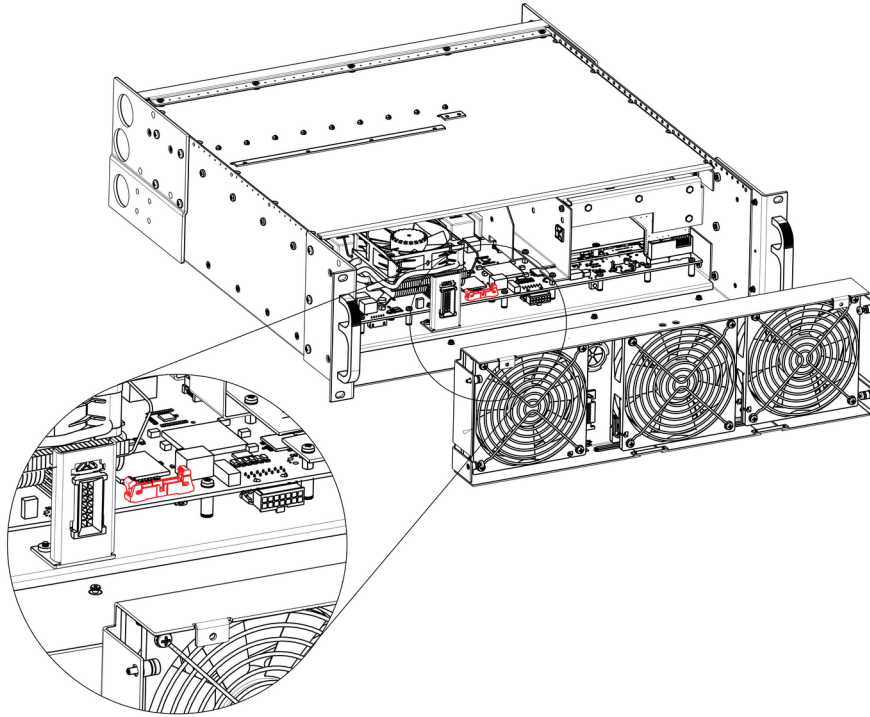

Image 15-84

3. Pull the cable out of the unit .

How to install the Keyboard Cable

To install the Keyboard Cable follow the same procedure in the reverse order.



There is a key on the connector to prevent incorrect insertion of the cable.



During assembly, make sure that the keyboard cable goes through the slot located on the bottom side of the 3RU Fan tray.

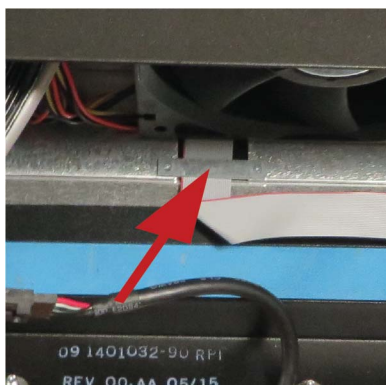

Image 15-85

15.32 3RU Fan Cable

Flow chart

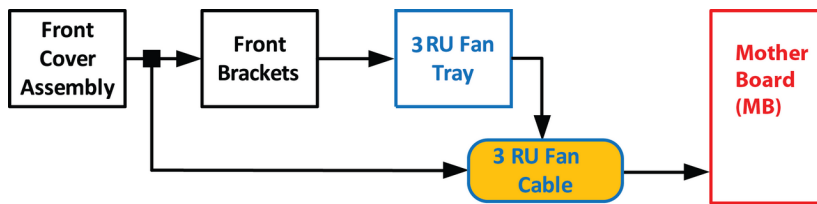

Image 15-86



The 3RU cable assembly provides power to the 3RU fans from the Motherboard.



One side of the cable is attached to a metal bracket that is accessible after the 3RU fan tray is removed. The other side of the cable assembly connects to the Motherboard.

Overview

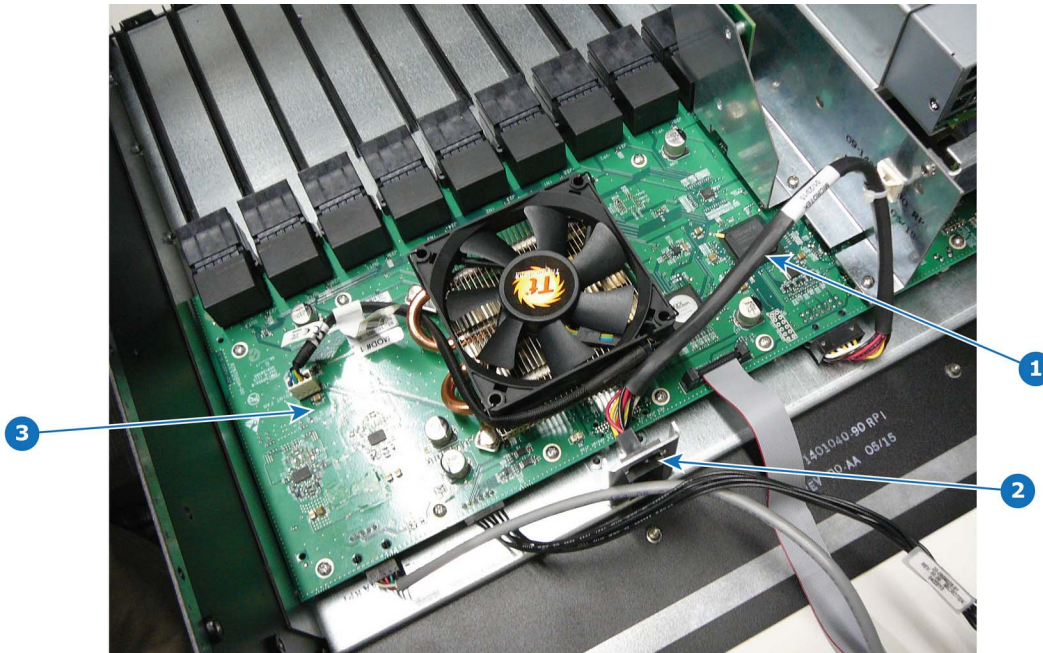

Image 15-87

- 1 3RU Fan cable
- 2 3RU Fan connector
- 3 Motherboard

Concerned parts

R767283K	S3 Cable Kit Set
----------	------------------

Necessary tools

- 1 x Phillips Screwdriver #2
- Hex Screwdriver

How to remove the 3RU Fan cable

1. In order to access the motherboard, follow the steps detailed in the other procedures to remove the Front Cover Assembly, Front brackets and 3RU Fan Tray.
2. Locate the 3RU cable connector that is exposed after the 3RU fan tray is removed. The connector is attached on a metal bracket that is vertically mounted in the chassis.

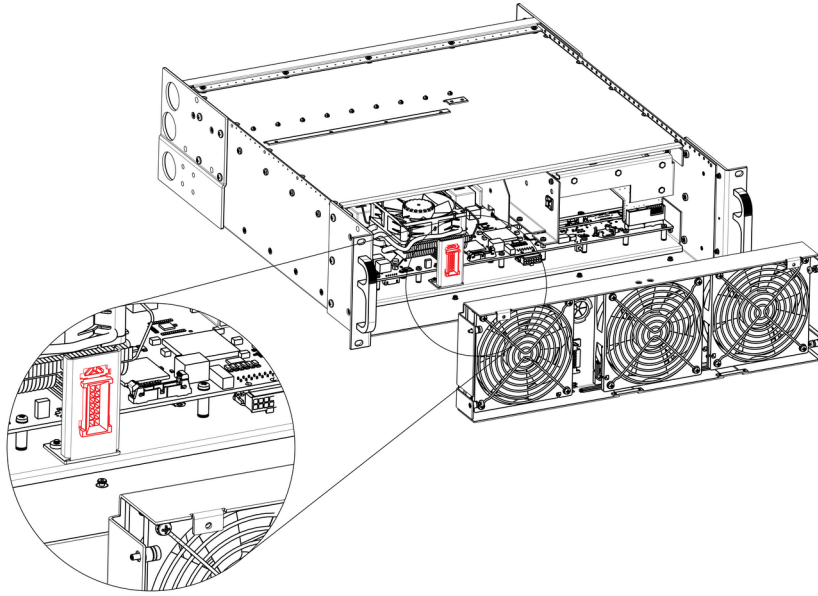

Image 15-88

3. Locate the snap lock on the top of the connector and push it back to release the connector from the bracket.

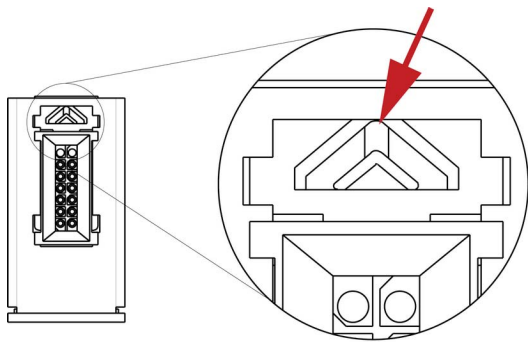

Image 15-89

4. Push the connector up until the slots in the metal bracket align with the flanges on the connectors.

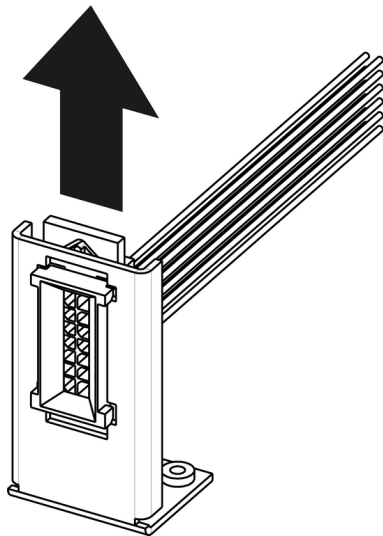

Image 15-90

5. Gently pull the 3RU cable assembly away from the bracket.

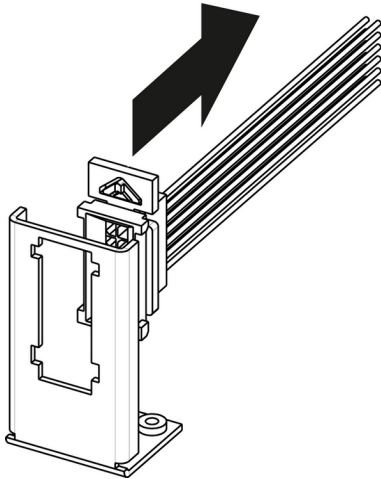

Image 15-91

6. Locate the 3RU cable that is plugged on the Motherboard.

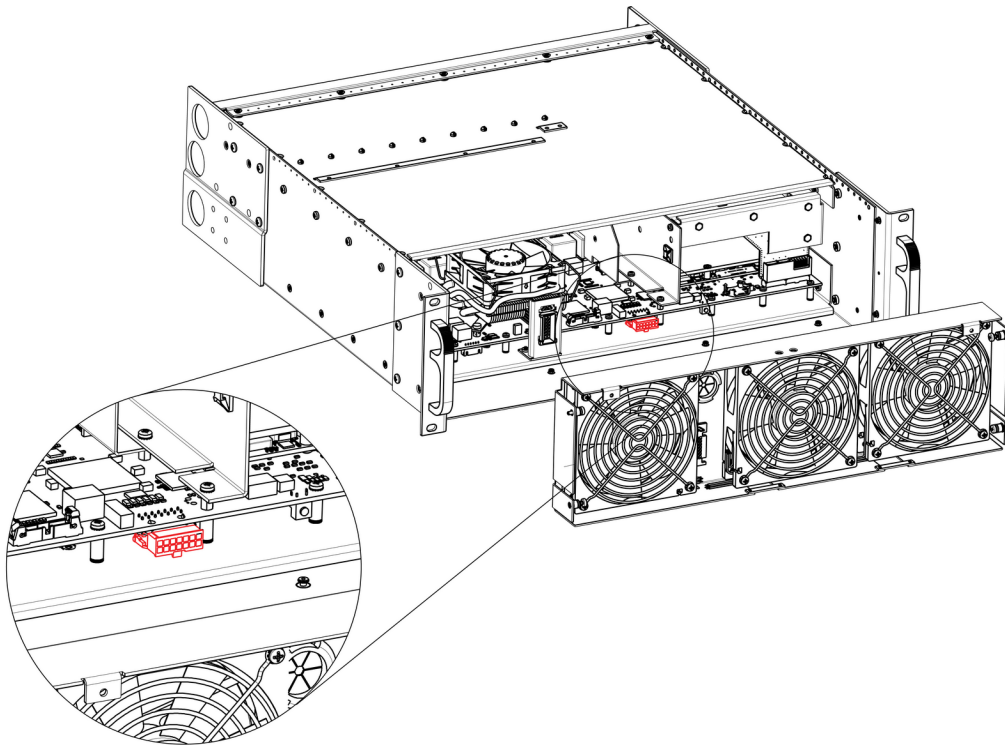

Image 15-92

7. Remove the 3RU cable by gently pushing it out.

Note: It could be necessary to release the cable tie that maintain the cable in place on the side Support Plate.

How to install the 3RU Fan Cable

To install the 3RU Fan Cable follow the same procedure in the reverse order.

15.33 Ethernet Cable

Flow chart

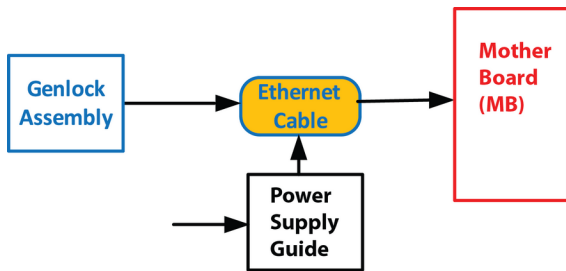

Image 15-93



The Ethernet cable connects the Genlock board to the Motherboard. This procedure provides instructions on how to remove the cable from both sides.



This procedure requires to remove the Power supply Guide to unplug the cable from the motherboard.

Overview

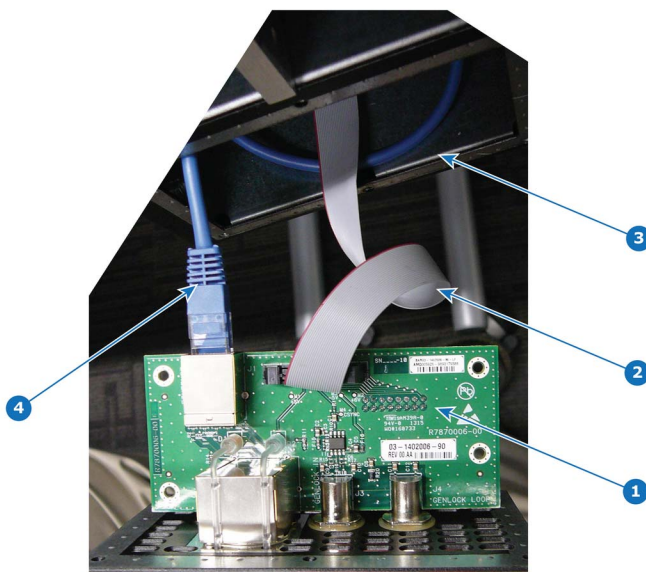

Image 15-94

- 1 Genlock card
- 2 Genlock cable
- 3 Chassis
- 4 Ethernet cable

Concerned parts

R767283K	S3 Cable Kit Set
----------	------------------

Necessary tools

- 1 x Phillips Screwdriver #2

How to remove the Ethernet cable

1. Remove the Genlock assembly and pull it away to expose the cables behind it (refer to the related procedure).
2. Locate the Ethernet connector on the Genlock assembly and push the locking clip on the Ethernet cable so it can be released from the socket.

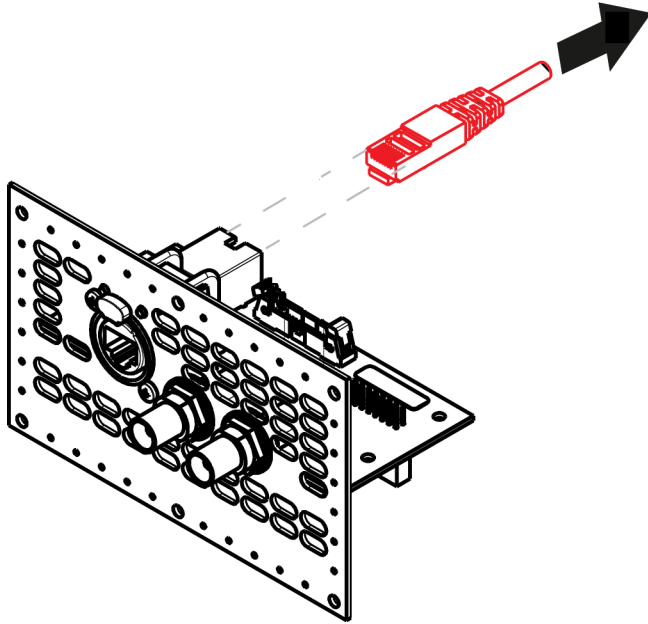

Image 15-95

Note: From this step, only the other end of the Ethernet cable stays connected to the motherboard. Unfortunately it is necessary to remove the Power supply Guide to unplug it. (refer to the "Process Overview", page 452).

3. Follow the steps detailed in other procedures to remove Power supply Guide.
4. Locate the Ethernet cable that is plugged on the Motherboard and push the locking clip on the Ethernet cable so it can be released from the socket.

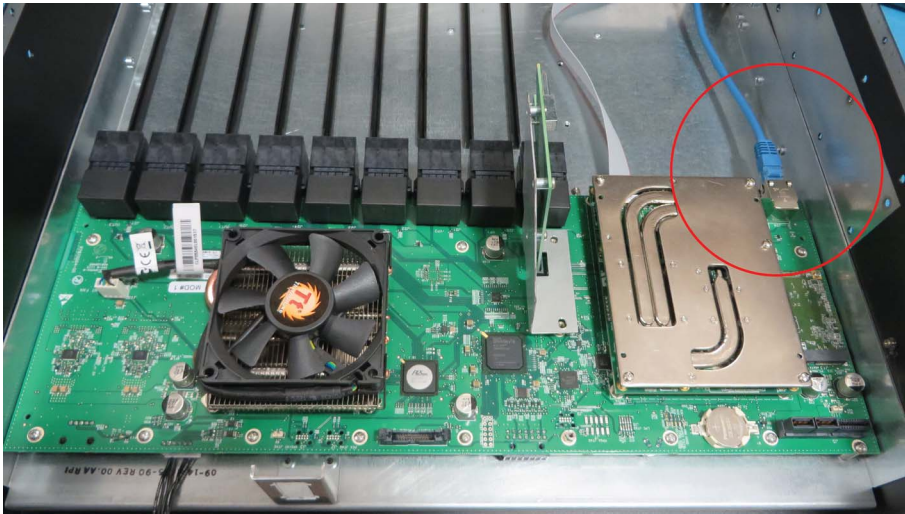

Image 15-96

5. Pull the cable out of the unit .

How to install the Ethernet Cable

To install the Ethernet Cable follow the same procedure in the reverse order.

15.34 Genlock Cable

Flow chart

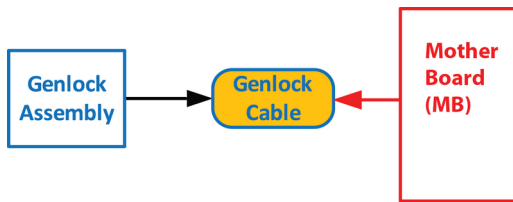

Image 15-97



The Genlock cable connects the Genlock board to the Motherboard. This procedure provides instructions on how to remove the cable from both sides.



One end of the Genlock cable is clamped between the Motherboard and the Motherboard mount. Remove this cable requires to separate these parts.

Overview

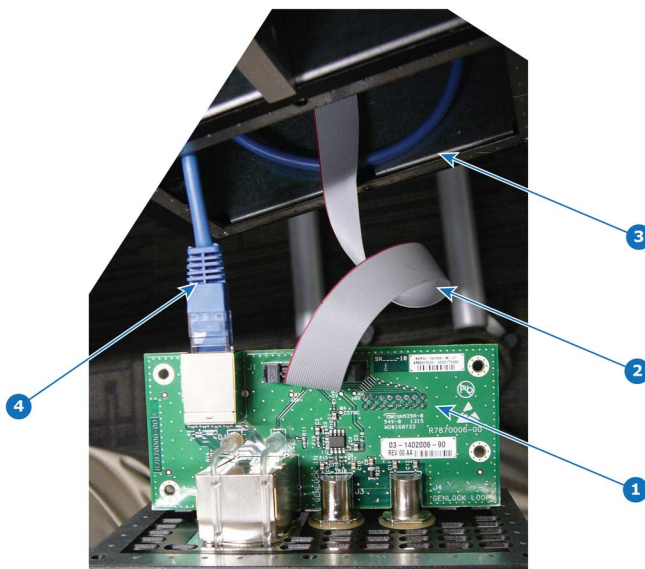

Image 15-98

- 1 Genlock card
- 2 Genlock cable
- 3 Chassis
- 4 Ethernet cable

Concerned parts

R767283K	S3 Cable Kit Set
----------	------------------

Necessary tools

- 1 x Phillips Screwdriver #2

How to remove the Ethernet cable

1. Remove the Genlock assembly and pull it away to expose the cables behind it (refer to the related procedure).
2. Locate the Genlock connector on the Genlock assembly and unlatch the ribbon cable from the connector and pull it up and away from the Genlock board.

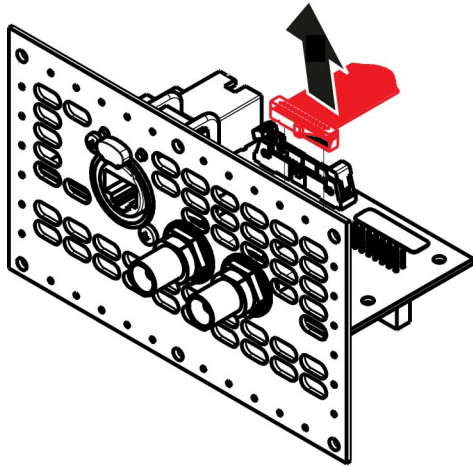

Image 15-99

Note: From this step, only the other end of the Genlock cable stays connected to the motherboard. Unfortunately it is necessary to remove the motherboard from the motherboard mount to unplug it. (refer to the "Process Overview", page 452).

3. Remove the following parts to access the motherboard :

- Rear cards (VPU, Link, I/O)
- CPU module.
- Link card interposer.

Note: Refer to the related procedures to remove these parts. Remove these parts requires removing lot of parts from the unit (Power supply, Power interposer, Power supply guide, Side Support Plate ...)

Note: It is not necessary to remove the solid state memory, the system battery and the other cables to give access to the motherboard fixing screws.

4. Remove the Motherboard from the Motherboard mount.

15. S3 Maintenance

- a) Remove the three m/f standoffs (4-40 X 3/16" .25") that attach the Motherboard to the Motherboard mount.
- b) Remove the five m/f standoffs (m2.5 X 8mm) that attach the Motherboard to the Motherboard mount.
- c) Remove the sixteen long pan head SEMS screws (4-40x.31" — SEMS refers to an integrate lock washer) that attach the Motherboard to the Motherboard mount.

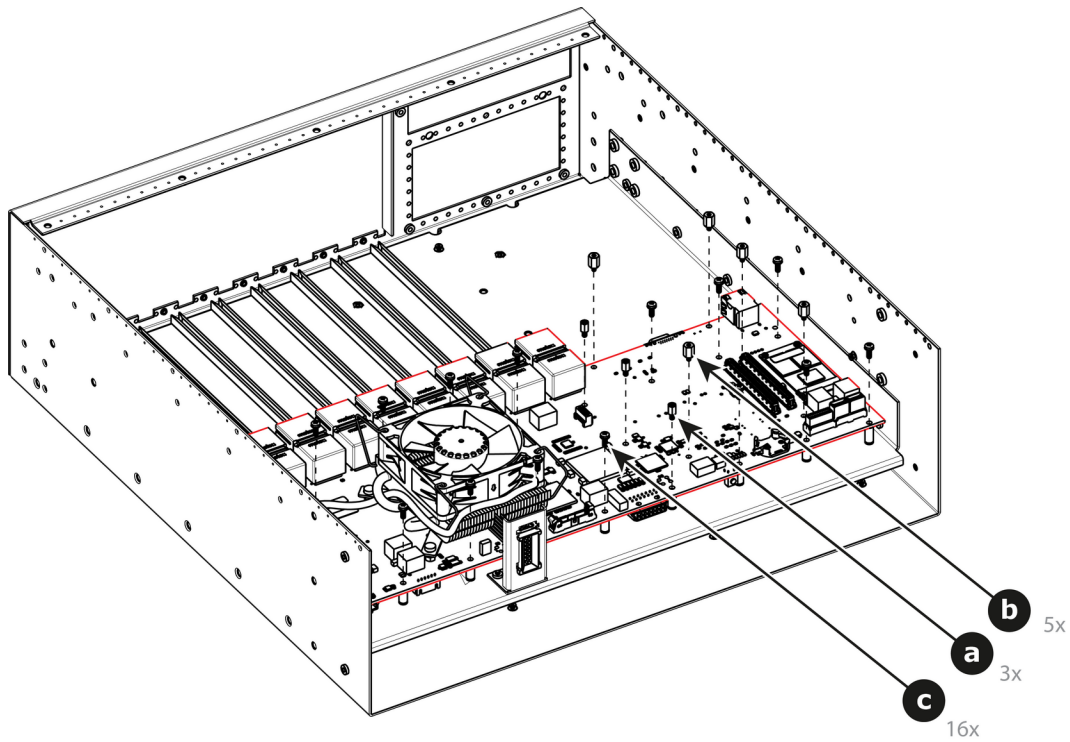

Image 15-100

5. Locate the Genlock cable that is plugged on the Motherboard.

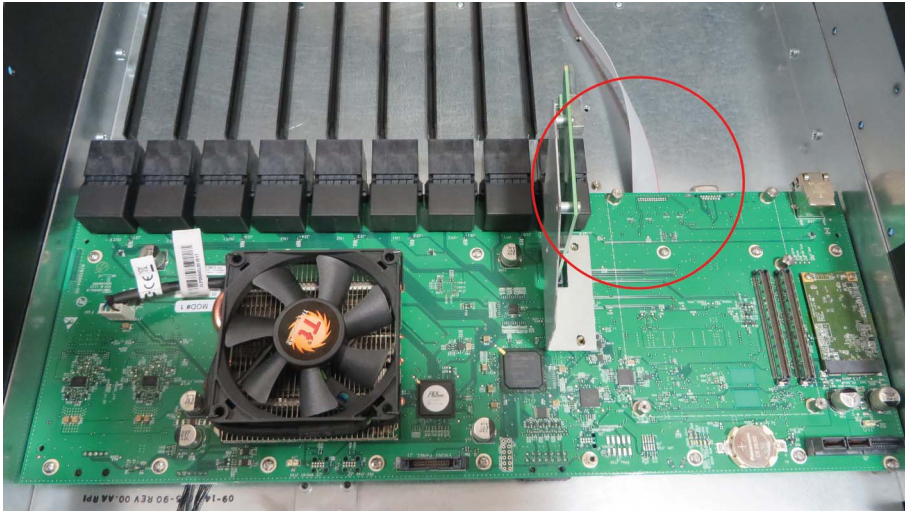

Image 15-101

6. Unplug the Genlock cable.
7. Pull the cable out of the unit .

How to install the Ethernet Cable

To install the Ethernet Cable follow the same procedure in the reverse order.

16. EX MAINTENANCE

About this chapter

This chapter describes how to service the EX expansion box by replacing individual components.

Simple servicing

The EX expansion box is based on a modular design that ensures easy serviceability. Users can swap most of the EX components in the case of damage, without shipping the unit to a Barco service center.

Methodology

Most procedures in these chapters include multiple steps to gain access to the parts requiring service. A workflow flow chart is provided indicating all of the procedures and their relationships. Please refer to the chart to familiarize yourself with the sequence of procedures.

ESD recommendations

The following precautions must be taken:

- Perform the service procedures only at approved anti-static work station equipped with anti- static mat.
- At all times use a conductive wrist strap attached to a solid earth ground.
- Always discharge yourself by touching a grounded bare metal surface before coming in contact with ESD sensitive electronic.



WARNING: Always switch power off and unplug the cords from the device before performing any maintenance operations described in this chapter.



WARNING: The device can be damaged by electrostatic discharge (ESD). When handling the device and any of its components, caution must be taken so that damage does not occur. Damage due to inappropriate handling is not covered by the warranty.

Overview

- EX unit Overview
- Process Overview
- Spare Parts Serviceable by All Users
- Event Master Cards
- Top Cover
- Power Supply
- CPU Module
- System Battery
- Motherboard
- Motherboard Fansink

16.1 EX unit Overview

Orientation and main components

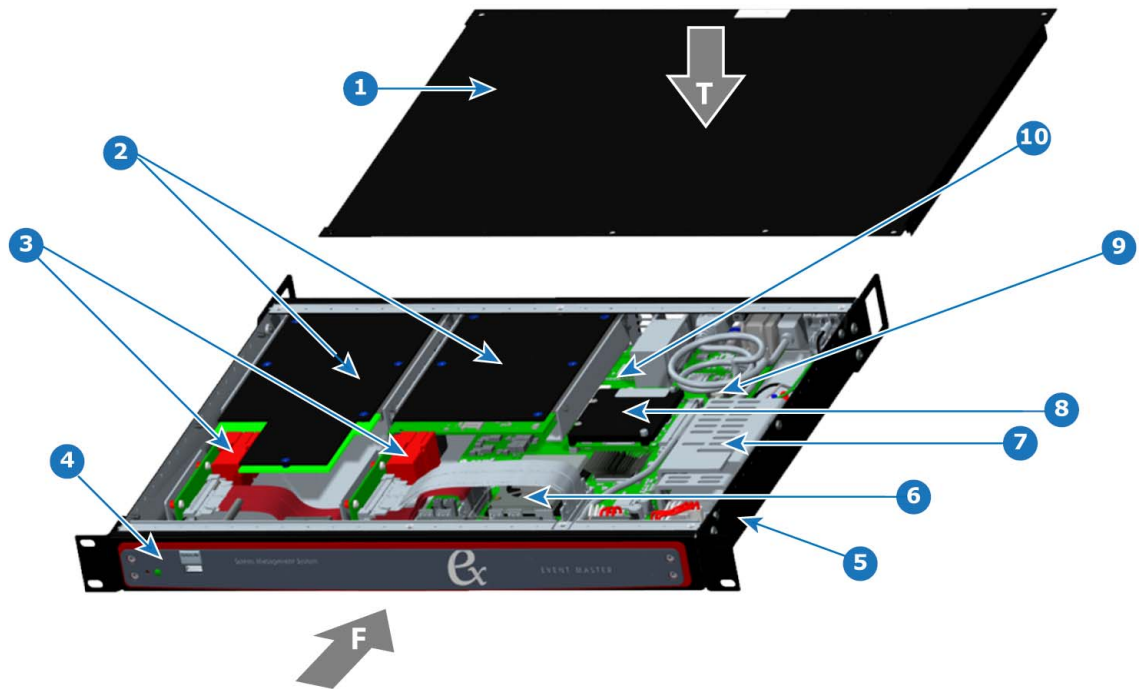
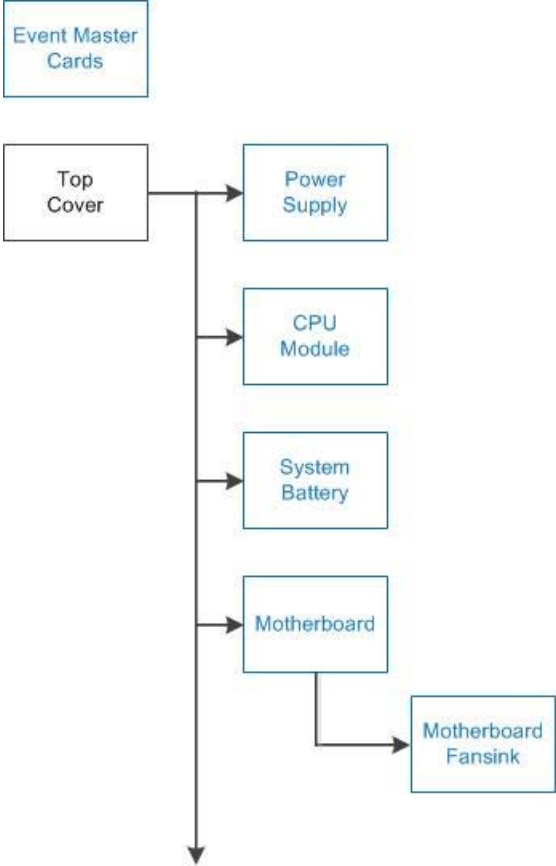

Image 16-1
Orientation and main components

T	Top	5	Chassis
F	Front	6	Motherboard Fan
1	Top Cover	7	Power Supply
2	Event Master Cards	8	CPU Module
3	Interposers	9	System Battery
4	Front Panel	10	Motherboard

16.2 Process Overview

Flow chart



BLUE: Serviceable by all Users.
BLACK: Non-serviceable item.

Image 16-2
EX service process overview flowchart

16.3 Spare Parts Serviceable by All Users

EX Spare Parts List

P/N	Description	Comments
R767210K	Power Supply, 132W, 12V Output	
R767263K	Kit, Fansink E2	Used on EX motherboard
R767287K	Kit, Motherboard EX	
R767288K	Kit, CPU Programmed ASM EX	
R767292K	Kit, Front Bezel EX	
R9004740	EM DVI Input Board	
R9004741	EM SDI Output Board	
R9004742	EM SDI Input Board	
R9004743	EM HDMI Output Board	
R9004744	EM HDMI-DP Input Board	
R9004745	EM DVI Output Board	
R9004758	S3 VPU Board	
R9004765	EM DisplayPort Output Board	
R9004785	Tri-Combo Input Board	
R9004786	Tri-Combo Output Board	
R9871179	Rear rackmount support kit	
V327007	System Battery	

16.4 Event Master Cards

Flow chart



Image 16-3
Event Master cards

Overview

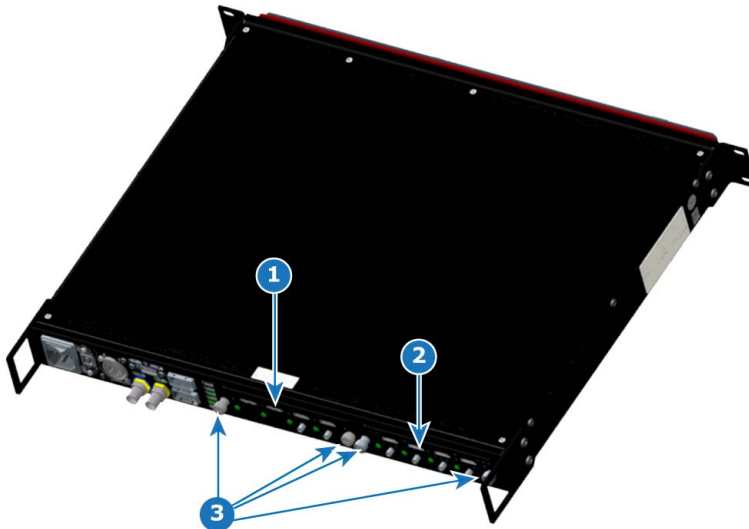

Image 16-4
EX chassis: Event Master card location

- 1 Card slot #1
- 2 Card slot #2
- 3 Card thumbscrews

Concerned parts

Spare Part Kit	Description
R9004740	DVI Input
R9004741	SDI Output
R9004742	SDI Input
R9004743	HDMI Output
R9004744	DP/HDMI Input
R9004745	DVI Output
R9004758	VPU card
R9004765	DP Output
R9004785	Tri-Combo Input
R9004786	Tri-Combo Output

Necessary tools

None.

How to remove a card

1. Locate the card that you wish to replace.
2. Loosen the left and right thumbscrews that hold the card in the chassis.
3. Grasp the thumbscrews, and gently pull the card out of the slot.



You may need to wobble the card a bit to loosen it from the mating connector as you pull it out.

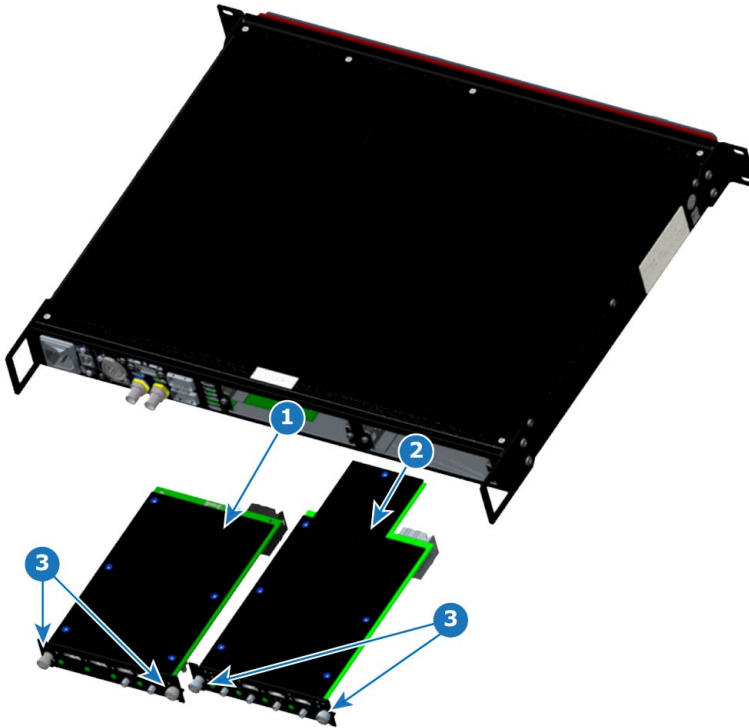

Image 16-5
EX chassis: with Event Master cards removed

- 1 Card from slot #1
- 2 Card from slot #2
- 3 Card thumbscrews

How to install a card

To install an Event Master input or output card, follow the steps of the removal procedure in reverse order.



Apply a little pressure on the card, until it is fully inserted in the back plane connector. At this point the sheet metal of the card should contact the sheet metal of the chassis.

16.5 Top Cover

Flow chart



Image 16-6
Top cover

Overview

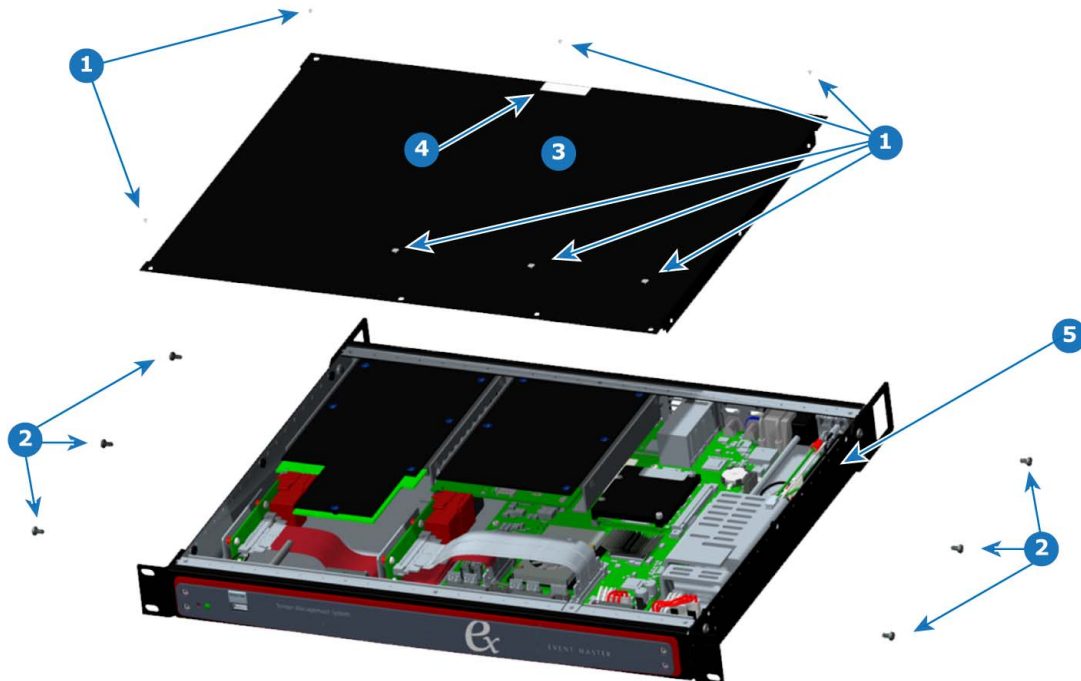

Image 16-7
Removal of EX top cover

- 1 Flat Head, 82° UC, 4-40 Screws
- 2 Pan Head, 6-32 Screws
- 3 Top cover
- 4 Tamper-evident label
- 5 Chassis

Concerned parts

Part Number	Description
02-1502002-90	EX Chassis
09-1502016-90	EX Chassis Cover
13-9850011-00	Tamper-evident Label
13-0280606-90	Flat Head, 82° UC, 4-40 Screw
13-0210808-90	Pan Head, 6-32 Screw

Necessary tools

- 1x Phillips Screwdriver #1
- 1x Phillips Screwdriver #2

How to remove the top cover

1. Remove the seven flat head, 4-40 screws from the top of the unit.
The middle screw along the rear edge of the top cover is under the tamper-evident label. Removing the screw may be easier, if you first remove the label.
2. Remove the six pan head, 6-32 screws from the sides of the unit.
3. Lift the top cover from the unit.

How to install the top cover

To install the top cover on the EX chassis, follow the steps of the removal procedure in reverse order.

16.6 Power Supply

Flow chart



Image 16-8
Power supply

Overview

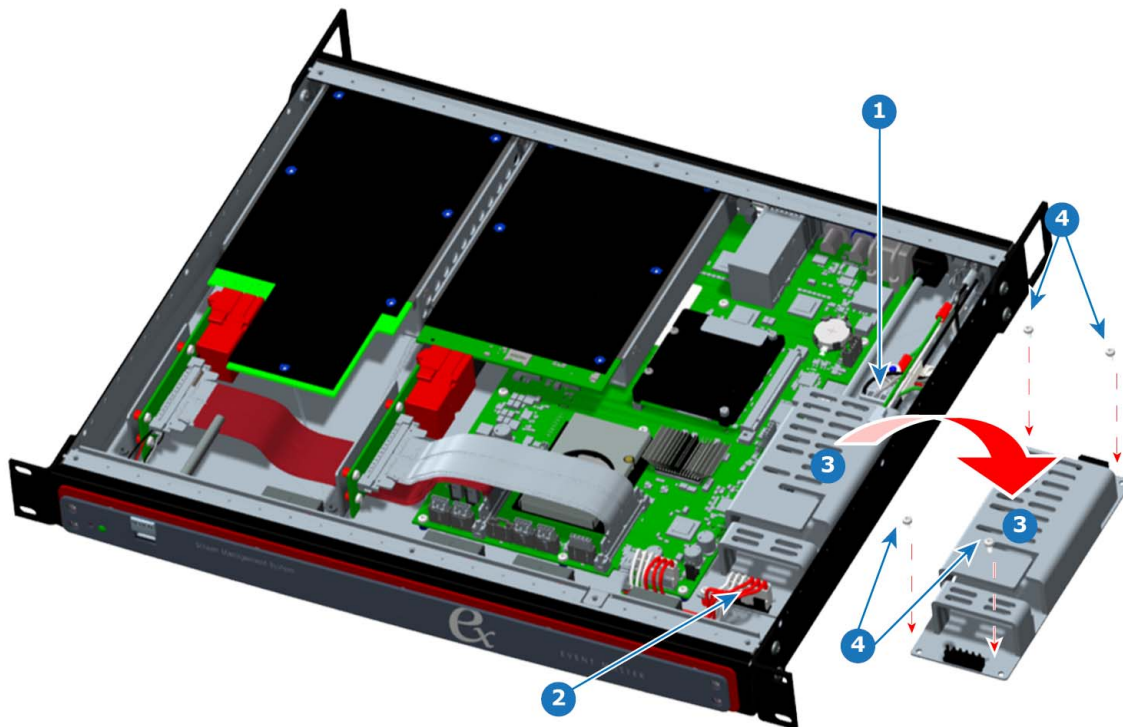

Image 16-9
Removal of power supply

- 1 DC Power Cable Assembly
- 2 AC Entry Cable Assembly
- 3 Power Supply
- 4 4-40 x25 SEMS Screws

Concerned parts

Part Number	Description
14-9500030-90	132W, 12V Power Supply
20-1502050-90	DC Power Cable Assembly
20-1502051-90	AC Entry Cable Assembly
13-0080608-90	4-40 x25 SEMS Screws (x4)

Necessary tools

- 1x Phillips Screwdriver #1
- 1x Phillips Screwdriver #2

How to remove the power supply

1. Remove the top cover.
2. Disconnect the DC power cable from the rear of the power supply.
3. Disconnect the AC entry cable from the front of the power supply.
4. Remove the four 4-40 x25, SEMS screws that fasten the power supply to the chassis.
5. Remove the power supply from the chassis.

How to install the power supply

To install the power supply in the EX chassis, follow the steps of the removal procedure in reverse order.



Make sure that the three rubber bumpons are on the bottom of the power supply before installing the power supply in the chassis. See image 16-10.

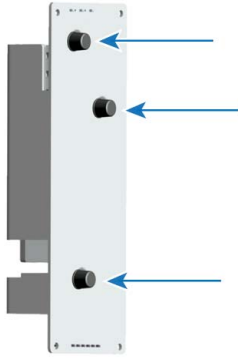

Image 16-10
Power supply bumpons

16.7 CPU Module

Flow chart



Image 16-11
CPU module

Overview

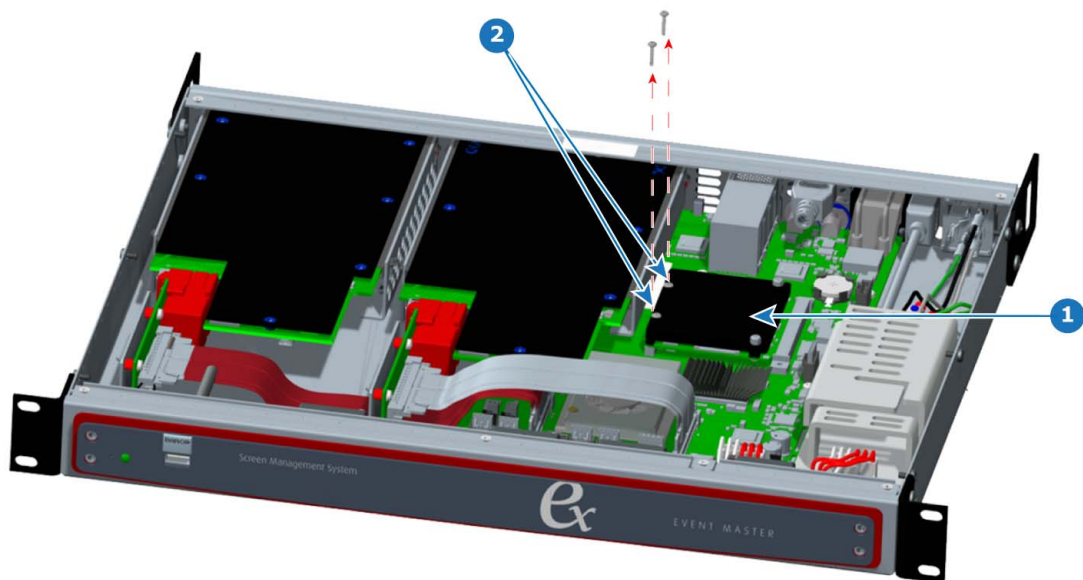

Image 16-12
CPU module components

- 1 CPU module
- 2 CPU module screws

Concerned parts

Part Number	Description
B3248009D	Motherboard fansink

Necessary tools

1x Phillips Screwdriver #1

How to remove the CPU module

1. Remove the top cover.
2. Remove the two screws from the side of the CPU module that is closest to the Event Master card slots.

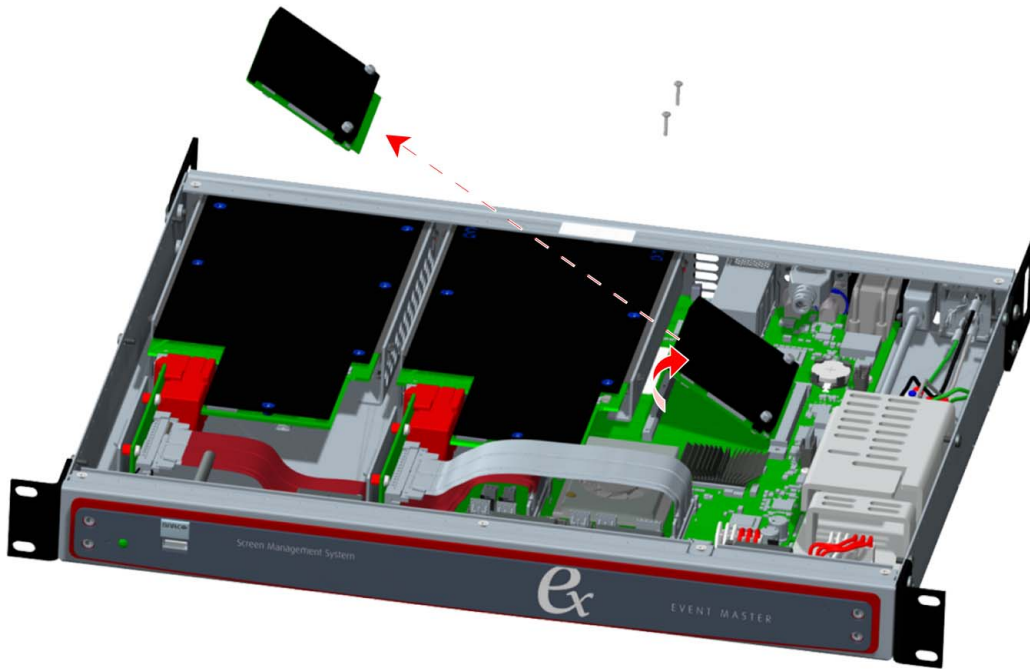

Image 16-13

3. Lift the freed edge of the CPU module, and pull it gently from the CPU-module connector on the motherboard.
4. Remove the CPU module from the chassis.

How to install the CPU module

To install the CPU module in the EX chassis, follow the steps of the removal procedure in reverse order.

16.8 System Battery

Flow chart

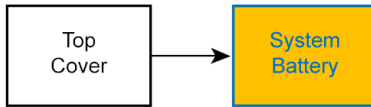

Image 16-14
System battery

Overview

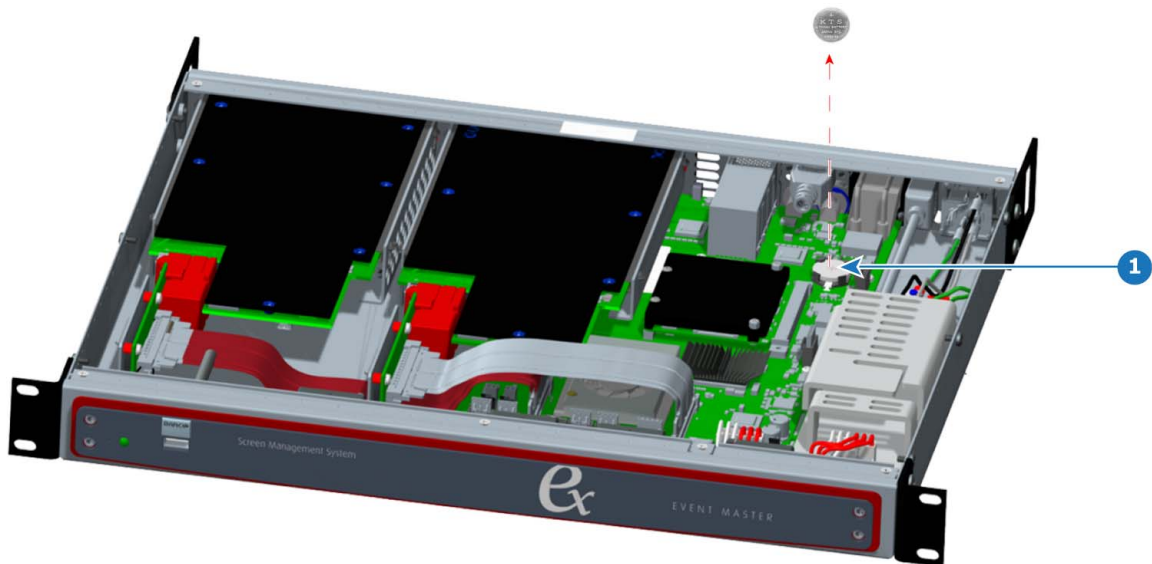

Image 16-15
System battery removal

- 1 System battery

Concerned parts

Part Number	Description
V327007	System battery

Necessary tools

None.

How to remove the system battery

1. Remove the top cover
2. Lift the system battery from its cradle, and remove it from the chassis.

How to install the system battery

To install the system battery in the EX chassis, follow the steps of the removal procedure in reverse order.



The + sign, indicating the positive pole of the battery, should face up.

16.9 Motherboard

Flow chart



Image 16-16
Motherboard

Overview

Several items must be removed from the chassis, before the motherboard may be removed. These items fall into two groups: rear-panel elements and chassis elements. Once these items have been removed, you may remove the motherboard.

Concerned parts

Part Number	Description
*	Event Master Series card
13-6200003-90	BNC Hex Nuts (x2)
13-6200004-90	BNC Toothed Washers (x2)
13-6200013-90	BNC Insulating Bushing (x1)
B1959987	Slot #1 Edge-card Ribbon Cable
02-1502006-90	EX Interposer (Slot #1)
B1959986	Slot #2 Edge-card Ribbon Cable
20-1502050-90	DC Power Cable
02-1502020-90	Edge-card Guide
B1959991	USB Type B Cable
B1959992	DisplayPort Cable
03-1502005-90	EX Motherboard
B3248009D	Fansink

* – Any Event Master series card fits Slot #1 and Slot #2.

Necessary tools

- 1x Phillips Screwdriver #1
- 1x Phillips Screwdriver #2

Rear-panel elements

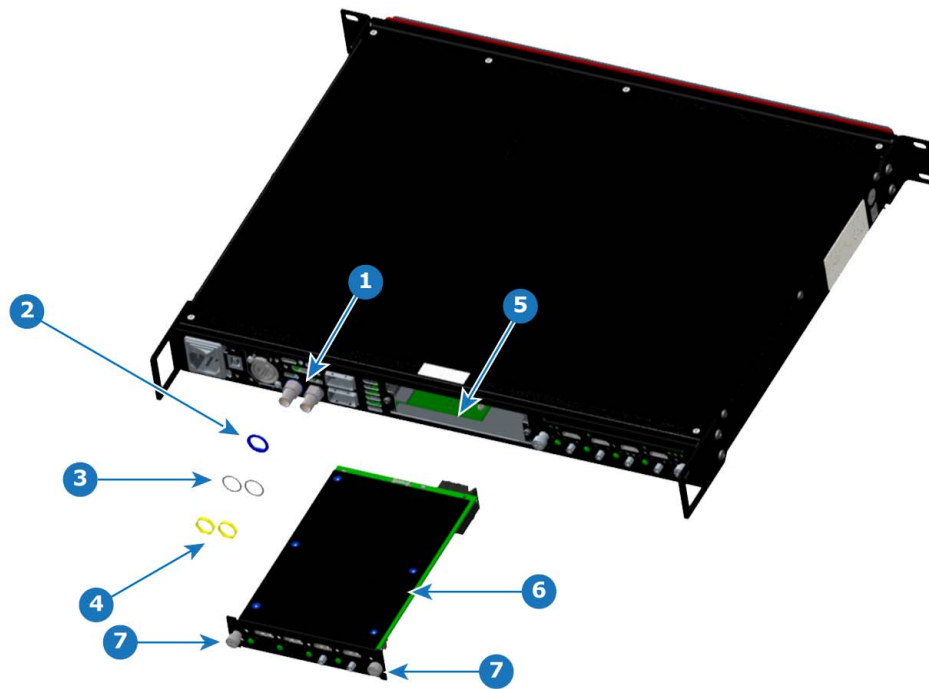

Image 16-17
Motherboard removal – rear-panel elements

- 1 Genlock (BNC) connectors
- 2 BNC insulating bushing
- 3 BNC toothed washers
- 4 BNC hex nuts
- 5 Slot #1
- 6 Event Master series card
- 7 Thumbscrews

1. Remove the hex nuts and the toothed washers from both Genlock BNC connectors, and remove the insulating bushing from the Genlock In BNC connector.
Note: Do not forget to install the insulating bushing on the Genlock In BNC connector during re-installation.
2. Loosen the thumbscrews on the Event Master series card in Slot #1, and remove the card from the slot.

Chassis elements

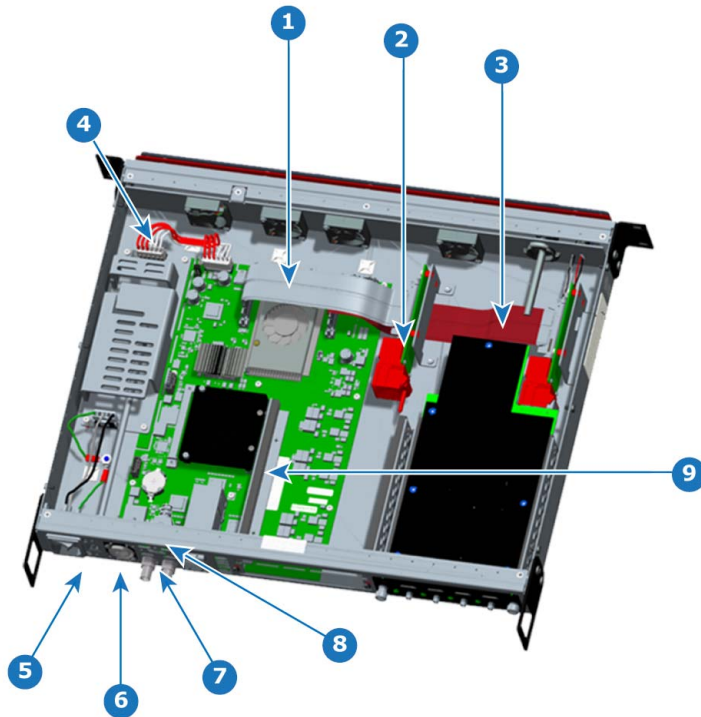

Image 16-18
Motherboard removal – chassis elements

- 1 Slot #1 edge-card ribbon cable
- 2 Slot #1 interposer
- 3 Slot #2 edge-card ribbon cable
- 4 DC power cable
- 5 USB Type B cable
- 6 RJ45 (Ethernet) connector
- 7 Genlock (BNC) connectors
- 8 DisplayPort cable
- 9 Event Master series card guide

1. Remove the top cover.
2. Snip the zip ties on the rear USB cable and the DisplayPort connector cable.
CAUTION: Not snipping the zip ties around the cables to be moved or removed may result in damage to the zip-tie mounts and the surfaces to which they are attached.
3. Disconnect the Slot #1 edge-card ribbon cable first from the motherboard, then from the Slot #1 interposer, and remove the ribbon cable from the chassis.
4. Remove the two screws that fasten the Slot #1 interposer to the floor of the chassis, and remove the interposer from the chassis. These are located on the bottom of the chassis near the front and close to the center of the chassis when looking from left to right.
5. Disconnect the Slot #2 edge-card ribbon cable first from the motherboard, then from the Slot #2 interposer, and remove the ribbon cable from the chassis.
6. Disconnect the DC power cable from the motherboard.
7. Disconnect the rear USB Type B connector cable from the rear-panel USB header on the motherboard.
8. Remove the screws above and below the rear-panel USB Type B connector, and remove the connector and its cable from the chassis.
9. Remove the two screws that fasten the RJ45 (Ethernet) mounting plate to the rear panel of the chassis. These screws are below and to the left, and above and to the right of the RJ45 mounting plate. Do not remove the screws on the mounting plate itself. The mounting plate should remain attached to the RJ45 connector on the motherboard.
10. Disconnect the DisplayPort cable from the motherboard.
11. Remove the two screws (just above the Genlock connectors) that fasten the DisplayPort cable to the rear panel, and remove the DisplayPort cable from the chassis.
12. Remove the two screws that fasten the Slot #1 card guide to the motherboard, and remove the card guide from the chassis.
13. Unscrew and remove the card-guide standoffs from the chassis. These go through slots in the motherboard, but the motherboard cannot be removed without first removing the standoffs.

The chassis elements are shown removed from the chassis in image 16-19.

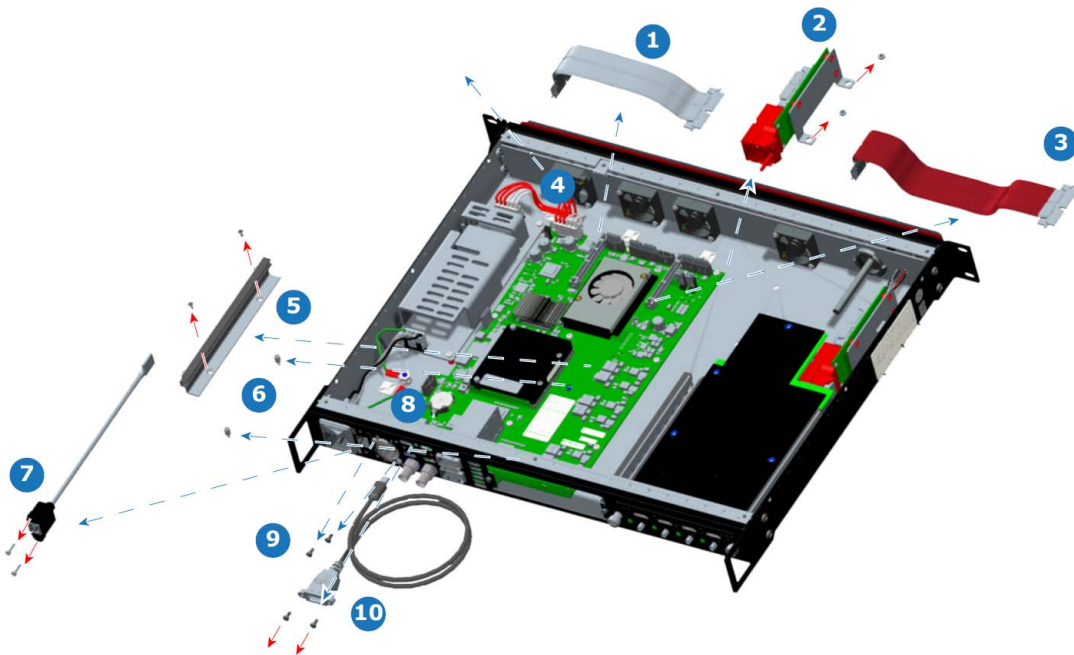

Image 16-19
Motherboard removal – chassis elements removed

- 1 Slot #1 edge-card ribbon cable
- 2 Slot #1 interposer
- 3 Slot #2 edge-card ribbon cable
- 4 DC power cable
- 5 Event Master series card guide
- 6 Card guide standoffs
- 7 USB Type B connector and cable
- 8 Rear-panel USB header
- 9 RJ45 rear-panel mounting screws
- 10 DisplayPort connector and cable

The motherboard

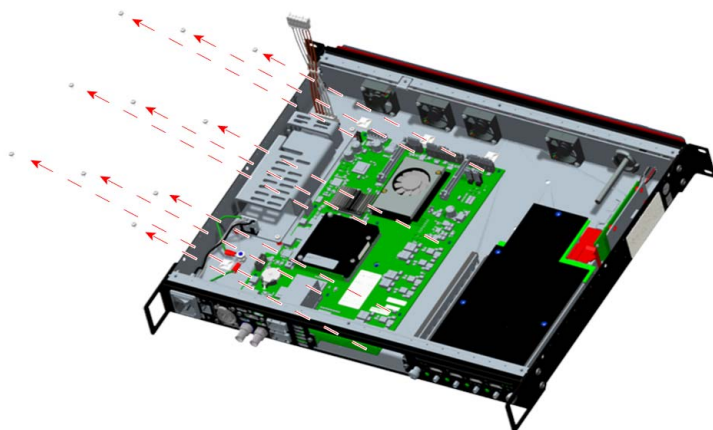

Image 16-20
Motherboard removal –motherboard screws

1. Remove the 11 screws that fasten the motherboard to the chassis.
2. Lift the front end of the motherboard, and rotate the motherboard up.

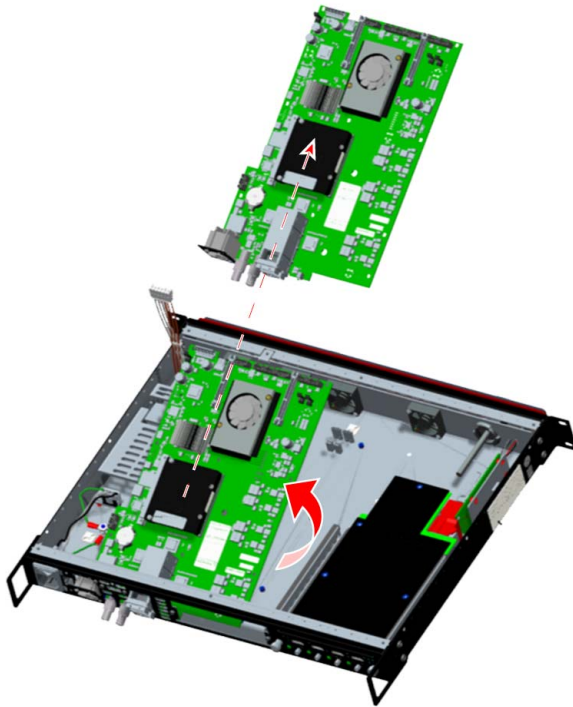

Image 16-21
Motherboard removal – removing the motherboard

3. Remove the motherboard from the chassis.
Note: There is one BNC insulator on the Genlock input connector. Make sure you put this to the side, so you can re-install it when re-installing the motherboard.

How to install the motherboard

To install the motherboard in the EX chassis, follow the steps of the removal procedure in reverse order.

1. Place the motherboard in the chassis.
2. Install the chassis elements.
3. Install the rear-panel elements.
Note: Do not forget to install the insulating bushing on the Genlock In BNC connector—both internal to the chassis and external—before installing the toothed washers and hex nuts.

16.10 Motherboard Fansink

Flow chart

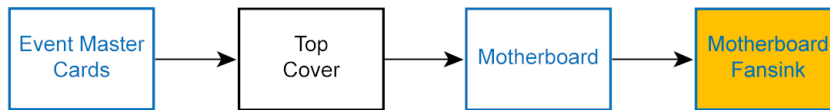

Image 16-22
Motherboard fansink

Overview

Because the fansink pins must be removed from the underside of the motherboard, the motherboard must be removed from the chassis before the fansink can be removed or replaced.

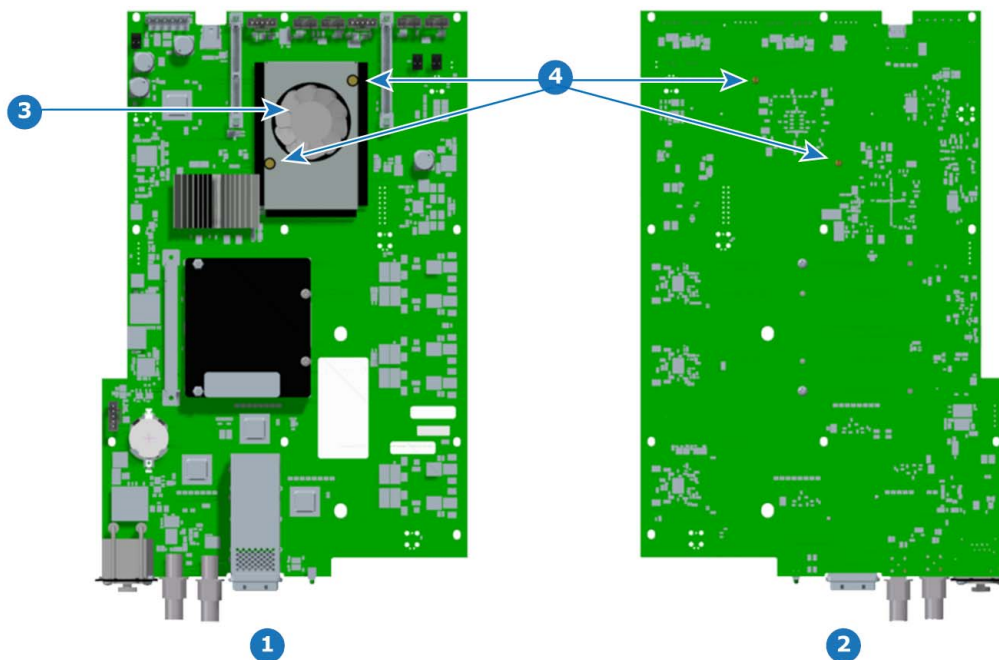

Image 16-23
Motherboard fansink components

- 1 Motherboard—topside view
- 2 Motherboard—underside view
- 3 Motherboard fansink
- 4 Fansink pins

Concerned parts

Part Number	Description
B3248009D	Motherboard fansink
R767263K	Fansink kit
02-1502005-90	EX motherboard

Necessary tools

None.

How to remove the motherboard fansink

1. Remove the top cover.
2. Remove the EX motherboard.
3. Turn the motherboard underside up.
4. Push the fansink pins in, so that they pass through the motherboard but do not separate from the fansink.
5. Turn the motherboard topside up, and remove the motherboard fansink, together with the fansink pins.

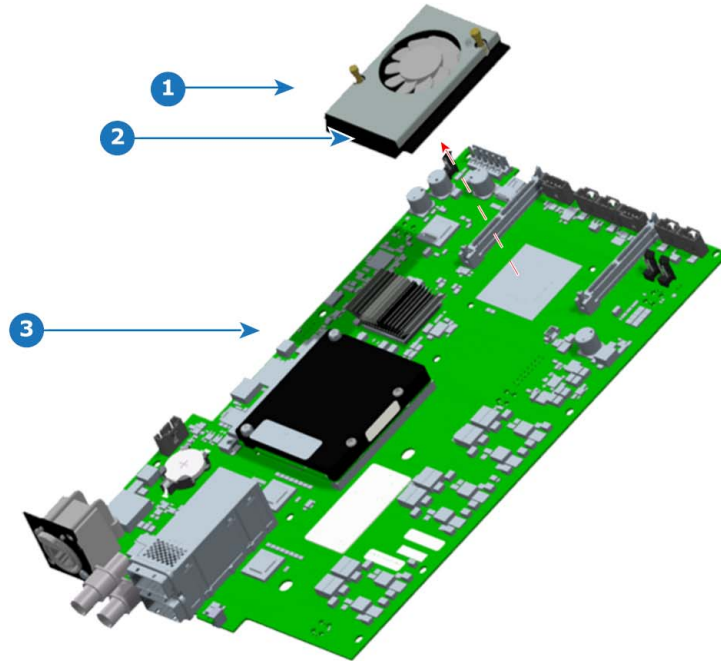

Image 16-24
Removal of motherboard fan

- 1 Motherboard fansink and pins
- 2 Open fins on the fansink
- 3 Motherboard

How to install the motherboard fansink

CAUTION: Do not reuse a fansink, once it has been removed from the motherboard. The thermal compound will no longer be properly located, and the compression of the pins during removal will prevent them from fastening properly to the motherboard. Use the fansink replacement kit R767263K.

To install a replacement fansink on the EX motherboard, follow these steps.

1. Align the fansink pins over the pin holes in the motherboard.
2. Place the replacement fansink on the EX motherboard.
Note: The open fins on the fan sink should point toward the CPU section as shown.
3. Push the fansink pins in, so that the tops of the pins are flush with the top of the fansink.

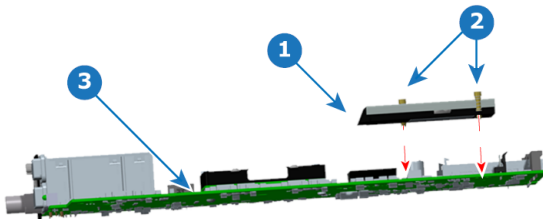

Image 16-25
Motherboard fansink pins

- 1 Fansink
- 2 Fansink pins
- 3 Motherboard

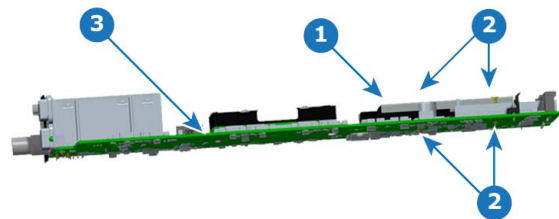

Image 16-26
Motherboard fansink installed

- 1 Fansink
- 2 Fansink pins
- 3 Motherboard

17. EC-30 MAINTENANCE

About this chapter

This chapter describes how to service the EC-30 controller.

Overview

- Servicing

17.1 Servicing

General

The EC-30 controller has no user-serviceable parts.



In the unlikely event your EC series controller requires service, please refer to the Return Material Authorization section in this manual prior to sending the unit back to the Barco Service Department.

EC-30 Overview

Orientation and main components

Front:

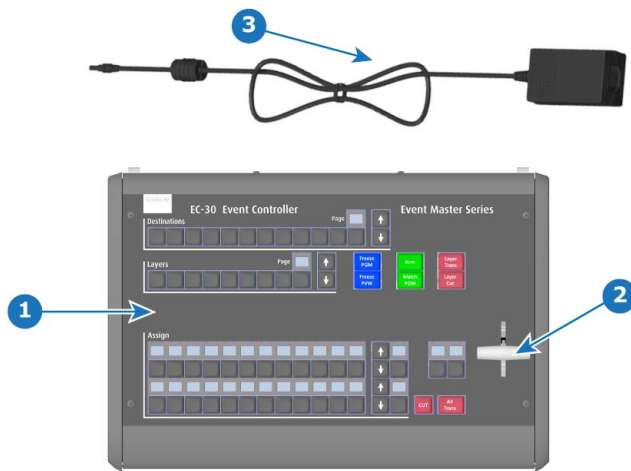

Image 17-1
EC-30 controller (Front view)

- 1 Keyboard
- 2 T-bar
- 3 25W, 12V power supply brick

Rear:

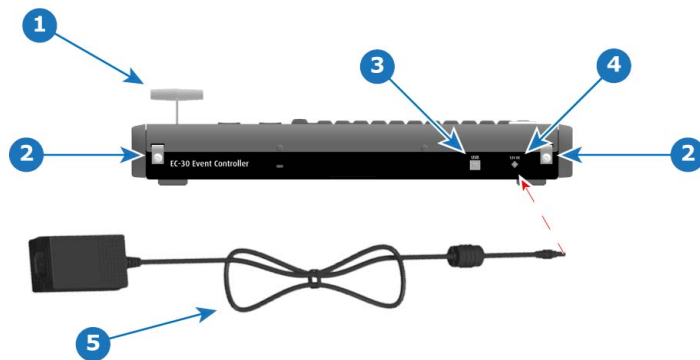

Image 17-2
EC-30 controller (Rear view)

- 1 T-bar
- 2 Strain-relief tabs
- 3 USB B to Host
- 4 DC power
- 5 25W, 12V power supply brick

18. EC-50 MAINTENANCE

About this chapter

This chapter describes how to service the EC-50 controller.

Overview

- Servicing

18.1 Servicing

General

Given the low failure rate experienced on this device, it is extremely rare to have to change parts on the EC-50 controller.



In the unlikely event your EC series controller requires service, please refer to the Return Material Authorization section in this manual prior to sending the unit back to the Barco Service Department.

The only parts that the user may have to change by itself is the work light and power fuse. The work light is a spare part provided by Barco (see spare parts list below). The fuse is not provided by Barco.

EC-50 Overview

Orientation and main components.

Front:



Image 18-1
EC-50 controller (Front view)

- 1 work light connector
- 2 Touch screen
- 3 Buttons of presentation the presentation video controller
- 4 T-bar

Rear:

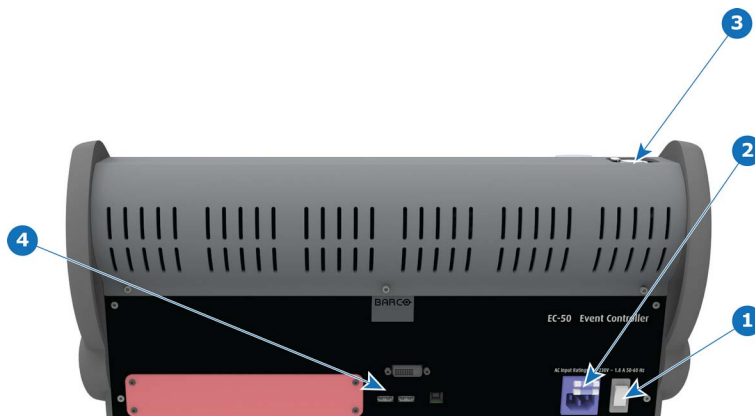

Image 18-2
EC-50 controller (Rear view)

- 1 Power switch
- 2 Power connector + fuse
- 3 work light connector
- 4 Communication connectors

EC-50 Spare Parts list

P/N	Description	Comments
R767327K	KIT DESKLIGHT EC-50	1x work light (flexible support with XLR connection)

Fuse**Specifications:**

Size	5x20mm
Amp Rating	5A
Voltage Rating	250V

Location:

The fuse compartment is located above the power supply connector.



Image 18-3

Spare fuse location:

A spare fuse is available in the fuse compartment.



Image 18-4



It is strongly recommended to quickly buy a new fuse when the spare fuse is used.

How to change power supply fuse:

18. EC-50 Maintenance

1. Note the open slot under the fuse compartment.



Image 18-5

2. Use a small flat blade screwdriver to open the fuse compartment.



Image 18-6

3. Change the fuse. Fuse should be installed in the fuse holder as shown:

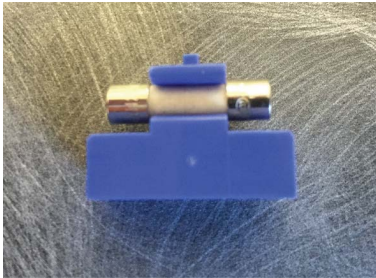

Image 18-7

4. Replace the fuse compartment in its location.

19. EC-200 MAINTENANCE

About this chapter

This chapter describes how to service the EC-200 controller.

Overview

- Servicing

19.1 Servicing

General

Given the low failure rate experienced on this device, it is extremely rare to have to change parts on the EC-200 controller.



In the unlikely event your EC series controller requires service, please refer to the Return Material Authorization section in this manual prior to sending the unit back to the Barco Service Department.

The only part that the user may have to change by himself is the work light . The work light is a spare part provided by Barco (see spare parts list below).

EC-200 Overview

Orientation and main components.

Front:

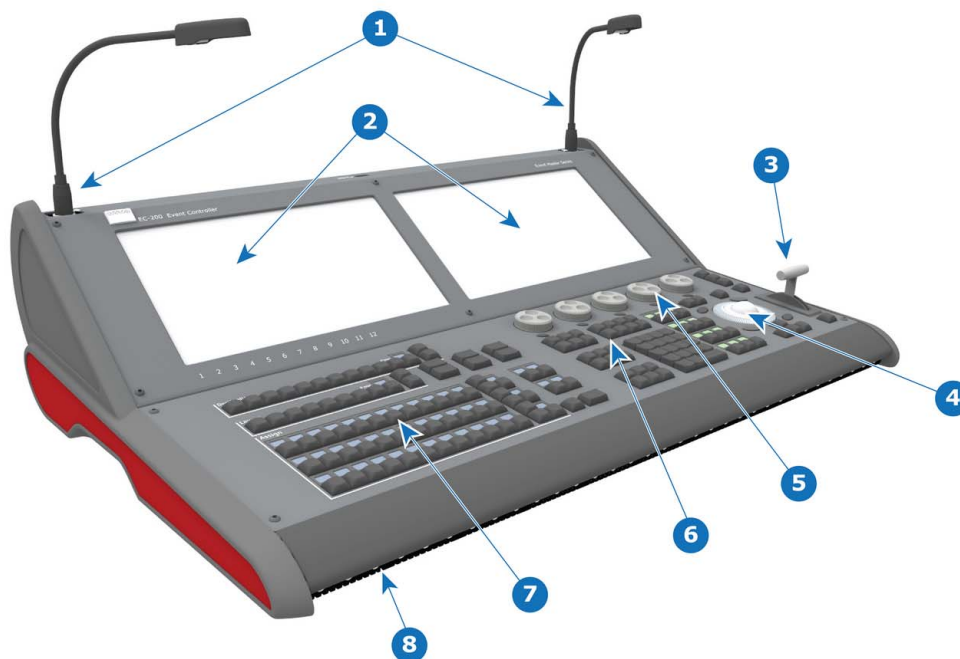

Image 19-1
EC-200 controller (Front view)

- 1 Work lights
- 2 Touch screens
- 3 T-bar
- 4 Mouse + arrow buttons
- 5 Rotary knobs
- 6 Function buttons, Top Functions and Numpad
- 7 Buttons of presentation (Destinations, Layers,...)
- 8 Front LED Lights

Rear:

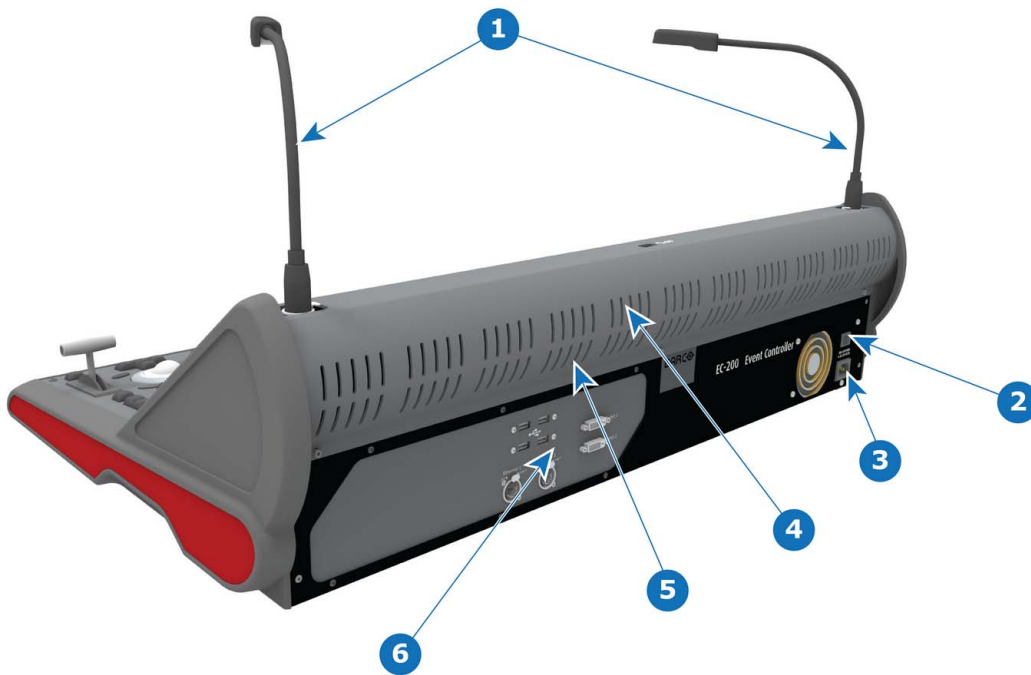

Image 19-2
EC-200 controller (Rear view)

- 1 Work lights
- 2 Power switch
- 3 Power connector
- 4 Rear Fan (Located behind rear vent holes)
- 5 Rear LED Lights (Located behind rear vent holes)
- 6 Communication connectors

EC-200 Spare Parts list

P/N	Description	Comments
R767327K	KIT DESKLIGHT EC-50	1x work light (flexible support with XLR connection)

20. ENVIRONMENTAL INFORMATION

Overview

- Disposal information
- RoHS compliance
- Production address

20.1 Disposal information

Disposal Information

Waste Electrical and Electronic Equipment



■ This symbol on the product indicates that, under the European Directive 2012/19/EU governing waste from electrical and electronic equipment, this product must not be disposed of with other municipal waste. Please dispose of your waste equipment by handing it over to a designated collection point for the recycling of waste electrical and electronic equipment. To prevent possible harm to the environment or human health from uncontrolled waste disposal, please separate these items from other types of waste and recycle them responsibly to promote the sustainable reuse of material resources.

For more information about recycling of this product, please contact your local city office or your municipal waste disposal service.

For details, please visit the Barco website at: <http://www.barco.com/en/AboutBarco/weee>

Disposal of batteries in the product



This product contains batteries covered by the Directive 2006/66/EC which must be collected and disposed of separately from municipal waste.

If the battery contains more than the specified values of lead (Pb), mercury (Hg) or cadmium (Cd), these chemical symbols will appear below the crossed-out wheeled bin symbol.

By participating in separate collection of batteries, you will help to ensure proper disposal and to prevent potential negative effects on the environment and human health.

20.2 RoHS compliance

中国大陆 RoHS (Chinese Mainland RoHS)

根据中国大陆《电器电子产品有害物质限制使用管理办法》(也称为中国大陆RoHS), 以下部分列出了Barco产品中可能包含的有毒和/或有害物质的名称和含量。中国大陆RoHS指令包含在中国信息产业部MCV标准:“电子信息产品中有毒物质的限量要求”中。

According to the “Management Methods for the Restriction of the Use of Hazardous Substances in Electrical and Electronic Products” (Also called RoHS of Chinese Mainland), the table below lists the names and contents of toxic and/or hazardous substances that Barco’s product may contain. The RoHS of Chinese Mainland is included in the MCV standard of the Ministry of Information Industry of China, in the section “Limit Requirements of toxic substances in Electronic Information Products”.

零件项目(名称) Component Name	有毒有害物质或元素 Hazardous Substances or Elements					
	铅 Pb	汞 Hg	镉 Cd	六价铬 Cr6+	多溴联苯 PBB	多溴二苯醚 PBDE
印制电路配件 Printed Circuit Assemblies	X	O	O	O	O	O
外接电(线)缆 External Cables	X	O	O	O	O	O
散热片(器) Heatsinks	O	O	O	O	O	O
底架 Chassis	O	O	O	O	O	O
电源供应器 Power Supply Unit	X	O	O	O	O	O
风扇 Fan	X	O	O	O	O	O
电池(组) Batteries	X	O	O	O	O	O
螺帽,螺钉(栓),螺旋(钉),垫圈,紧固件 Nuts, bolts, screws, washers, Fasteners	O	O	O	O	O	O

本表格依据SJ/T 11364的规定编制
This table is prepared in accordance with the provisions of SJ/T 11364.

O: 表示该有毒有害物质在该部件所有均质材料中的含量均在 GB/T 26572 标准规定的限量要求以下。
O: Indicates that this toxic or hazardous substance contained in all of the homogeneous materials for this part is below the limit requirement in GB/T 26572.

X: 表示该有毒有害物质至少在该部件的某一均质材料中的含量超出 GB/T 26572 标准规定的限量要求。
X: Indicates that this toxic or hazardous substance contained in at least one of the homogeneous materials used for this part is above the limit requirement in GB/T 26572.

在中国大陆销售的相应电子信息产品(EIP)都必须遵照中国大陆《电子电气产品有害物质限制使用标识要求》标准贴上环保使用期限(EFUP)标签。Barco产品所采用的EFUP标签(请参阅实例, 徽标内部的编号使用于指定产品)基于中国大陆的《电子信息产品环保使用期限通则》标准。

All Electronic Information Products (EIP) that are sold within Chinese Mainland must comply with the “Marking for the restriction of the use of hazardous substances in electrical and electronic product” of Chinese Mainland, marked with the Environmental Friendly Use Period (EFUP) logo. The number inside the EFUP logo that Barco uses (please refer to the photo) is based on the “General guidelines of environment-friendly use period of electronic information products” of Chinese Mainland.



Turkey RoHS compliance



■ Türkiye Cumhuriyeti: AEEE Yönetmeliğine Uygundur.
[Republic of Turkey: In conformity with the WEEE Regulation]

20.3 Production address

Factories

Barco Inc.

3000 Technology Road

Angleton, TX 77515

USA

Barco Inc.

2105 Gracy Farms Lane

Austin, TX 78758

USA

A. SPECIFICATIONS

About this annex

This chapter gives an overview of the specifications of the Event Master devices.

A.1 Specifications of E2

E2 Specifications

Genlock	Analog reference input/loop on BNC connectors; bi-level and blackburst at SD and tri-level at HD S3D Sync: 4x input Din connector, 2x output Din connector
Program output	8 program outputs configurable as single screens or tiled/blended widescreens <ul style="list-style-type: none"> Configurable from 8x 2048X1200@60 max to 2 x 4096x2400@60 max Independent edge blending/feathering control for all four sides
Scaled Aux outputs	User definable from 4 x 2048x1200@60 to 1 x 4K@60 All outputs can be defined as Aux destinations for a total of 12 Aux outputs Output color correction
Mixers	<ul style="list-style-type: none"> Native resolution background mixer per output screen Independent layer transitions or full Preview/Program transition Flexible layer allocation – up to 16 mixable or 32 single scalable PIP/key layers assignable to Program output screens
Video inputs	28 inputs via 8 input cards (Event Master series cards) <ul style="list-style-type: none"> Up to 8 x 4K inputs - each input card supports up to 4K@60p 8 x SD/HD/3G SDI (6G ready) 8 x HDMI 1.4a (297 Mpix/sec max) 8 x DisplayPort 1.1 (330 Mpix/sec max) 4 x Dual Link DVI (330)
Video outputs	14 outputs via 4 output cards (Event Master series cards) <ul style="list-style-type: none"> Up to 3 x 4K outputs - each output card supports up to 4K@60 p 4 x SD/HD/3G SDI (6G ready) 8 x HDMI 1.4a (297 Mpix/sec max) 2 x HDMI 1.4a for Multiviewer (297 Mpix/sec max)
Still stores	Up to 100 HD stills available in background, Aux or PIP
Layer effects	<ul style="list-style-type: none"> Borders (hard, soft, halo) and drop shadows Color effects Strobe, H&V flip Luma key PIP moves via Keyframes
Multiviewer	<ul style="list-style-type: none"> Flexible user-definable layouts Monitor all Inputs and Outputs, including Preview and Aux Two outputs Dedicated hardware same E2 Event Master Processors
Expandability	<ul style="list-style-type: none"> Easily expandable for larger display applications via proprietary links Link units to increase available Inputs and Outputs for larger tiled/blended widescreen applications Expansion via simple linking - up to 2 chassis E2 ships with the ability to link 2 chassis for expansion. Linking additional chassis will be available in a future software release.
HDCP	HDCP compliant
Control	<ul style="list-style-type: none"> Event Master screen management software for PC or MAC Ethernet RJ-45, 1000/100/10 Mbps autosense
Serviceability	<ul style="list-style-type: none"> Field-Serviceable I/O and processing cards (not hot-swappable) Hot-swappable dual-redundant power supplies

Dimensions	<ul style="list-style-type: none">• Height: 17.8 cm (7.0 in) - 4 RU rackmount• Width: 43.2 cm (17 in) without chassis handles, 48.3 cm (19 in) with chassis handles attached• Depth: 56.9 cm (22.4 in) from front panel to rear panel, 62.2 cm (24.5 in) overall
Weight	31 kg / 68 lbs
Power	<ul style="list-style-type: none">• Input power: 100-240 VAC 50/60Hz 700W• Dual-redundant, hot-swappable power supplies
Environmental temperature	0-40° C / 32-104 F
Environmental humidity	0-95% non-condensing
Warranty	3 years parts and labor

A.2 Specifications of E2 Jr.

E2 Jr. Specifications

Genlock	Analog reference input/loop on BNC connectors; bi-level and blackburst at SD and tri-level at HD S3D Sync: 4x input Din connector, 2x output Din connector
Program output	4 program outputs configurable as single screens or tiled/blended widescreens <ul style="list-style-type: none"> Configurable from 4X 2048X1200@60 max to 1 x 4096x2400@60 max Independent edge blending/feathering control for all four sides
Scaled Aux outputs	User definable from 4 x 2048x1200@60 to 1 x 4K@60 All outputs can be defined as Aux destinations for a total of 8 Aux outputs Output color correction
Mixers	<ul style="list-style-type: none"> Native resolution background mixer per output screen Independent layer transitions or full Preview/Program transition Flexible layer allocation – up to 8 mixable or 16 single scalable PIP/key layers assignable to Program output screens
Video inputs	16 inputs via 4 input cards (Event Master series cards) <ul style="list-style-type: none"> Up to 4 x 4K inputs - each input card supports up to 4K@60p 4 x SD/HD/3G SDI (6G ready) 6 x HDMI 1.4a (297 Mpix/sec max) 6 x DisplayPort 1.1 (330 Mpix/sec max)
Video outputs	10 outputs via 3 output cards (Event Master series cards) <ul style="list-style-type: none"> Up to 2 x 4K outputs - each output card supports up to 4K@60 p 4 x SD/HD/3G SDI (6G ready) 4 x HDMI 1.4a (297 Mpix/sec max) 2 x HDMI 1.4a for Multiviewer (297 Mpix/sec max)
Still stores	Up to 100 HD stills available in background, Aux or PIP
Layer effects	<ul style="list-style-type: none"> Borders (hard, soft, halo) and drop shadows Color effects Strobe, H&V flip Luma key PIP moves via Keyframes
Multiviewer	<ul style="list-style-type: none"> Flexible user-definable layouts Monitor all Inputs and Outputs, including Preview and Aux Two outputs Dedicated hardware same E2 Event Master Processors
Expandability	Linking is available as an upgrade option
HDCP	HDCP compliant
Control	<ul style="list-style-type: none"> Event Master screen management software for PC or MAC Ethernet RJ-45, 1000/100/10 Mbps autosense
Serviceability	<ul style="list-style-type: none"> Field-serviceable I/O and processing cards (not hot-swappable) Hot-swappable dual-redundant power supplies
Dimensions	<ul style="list-style-type: none"> Height: 17.8 cm (7.0 in) - 4 RU rackmount Width: 43.2 cm (17 in) without chassis handles, 48.3 cm (19 in) with chassis handles attached Depth: 56.9 cm (22.4 in) from front panel to rear panel, 62.2 cm (24.5 in) overall
Weight	27.8 kg / 61 lbs

Power	<ul style="list-style-type: none">• Input power: 100-240 VAC 50/60Hz 700W• Dual-redundant, hot-swappable power supplies
Environmental temperature	0-40° C / 32-104 F
Environmental humidity	0-95% non-condensing
Warranty	3 years parts and labor

A.3 Specifications of S3–4K

S3–4K Specifications

Genlock	Analog reference input/loop on BNC connectors; bi-level and blackburst at SD and tri-level at HD S3D Sync: 4x input Din connector, 2x output Din connector
Program output	4 program outputs configurable as single screens or tiled/blended widescreens <ul style="list-style-type: none"> Configurable from 4X 2048X1200@60 max to 1 x 4096x2400@60 max Independent edge blending/feathering control for all four sides
Scaled Aux outputs	User definable from 4 x 2048x1200@60 to 1 x 4K@60 Output color correction
Mixers	<ul style="list-style-type: none"> Native resolution background mixer per output screen Independent layer transitions or full Preview/Program transition Flexible layer allocation – 4 mixable or 8 single scalable PIP/key layers assignable to any Program output screen
Video inputs	12 inputs via 3 input cards (Event Master series cards) <ul style="list-style-type: none"> Up to 3 x 4K inputs - each input card supports up to 4K@60p 4 x SD/HD/3G SDI (6G ready) 4 x HDMI 1.4a (297 Mpix/sec max) 4 x DisplayPort 1.1 (330 Mpix/sec max)
Video outputs	10 outputs via 3 output cards (Event Master series cards) <ul style="list-style-type: none"> Up to 2x 4K outputs - each output card supports up to 4K@60 p 4 x SD/HD/3G SDI (6G ready) 4x HDMI 1.4a (297 Mpix/sec max) 2 x HDMI 1.4a for Multiviewer (297 Mpix/sec max)
Still stores	Up to 100 HD stills available in background, Aux or PIP
Layer effects	<ul style="list-style-type: none"> Borders (hard, soft, halo) and drop shadows Color effects Strobe, H&V flip Luma key PIP moves via Keyframes
Multiviewer	<ul style="list-style-type: none"> Flexible user-definable layouts Monitor all Inputs and Outputs, including Preview and Aux Two outputs Dedicated hardware same as E2 Event Master Processor
Expandability	<ul style="list-style-type: none"> Easily expandable for larger display applications via proprietary links Link units to increase available Inputs and Outputs for larger tiled/blended widescreen applications Expansion via simple linking - up to 4 chassis S3-4K ships with the ability to link 2 chassis for expansion. Linking up to 4 chassis will be available in a future software release.
HDCP	HDCP compliant
Control	<ul style="list-style-type: none"> Event Master screen management software for PC or MAC Ethernet RJ-45, 1000/100/10 Mbps autosense
Serviceability	<ul style="list-style-type: none"> Field-Serviceable I/O and processing cards (not hot-swappable) Hot-swappable dual-redundant power supplies

Dimensions	<ul style="list-style-type: none">• Height: 13.26 cm (5.22 in) - 3 rack mount units• Width: 43.2 cm (17 in) without chassis handles, 48.3 cm (19 in) with chassis handles attached• Depth: 54 cm (21.33 in) overall
Weight	24 kg / 53 lbs
Power	<ul style="list-style-type: none">• Input power: 100-240 VAC 50/60Hz 700W• Dual-redundant, hot-swappable power supplies; same as E2 Event Master processor
Environmental temperature	0-40° C / 32-104 F
Environmental humidity	0-95% non-condensing
Warranty	3 years parts and labor

A.4 Specifications of S3–4K Jr.

S3–4K Jr. Specifications

Genlock	Analog reference input/loop on BNC connectors; bi-level and blackburst at SD and tri-level at HD S3D Sync: 4x input Din connector, 2x output Din connector
Program output	4 program outputs configurable as single screens or tiled/blended widescreens <ul style="list-style-type: none"> Configurable from 4X 2048X1200@60 max to 1 x 4096x2400@60 max Independent edge blending/feathering control for all four sides
Scaled Aux outputs	User definable from 4 x 2048x1200@60 to 1 x 4K@60 Output color correction
Mixers	<ul style="list-style-type: none"> Native resolution background mixer per output screen Independent layer transitions or full Preview/Program transition Flexible layer allocation – 2 mixable or 4 single scalable PIP/key layers assignable to any Program output screen
Video inputs	8 inputs via 2 input cards (Event Master series cards) <ul style="list-style-type: none"> Up to 2 x 4K inputs - each input card supports up to 4K@60p 4 x SD/HD/3G SDI (6G ready) 2 x HDMI 1.4a (297 Mpix/sec max) 2 x DisplayPort 1.1 (330 Mpix/sec max)
Video outputs	6 outputs via 2 output cards (Event Master series cards) <ul style="list-style-type: none"> Up to 1x 4K outputs - each output card supports up to 4K@60 p 4x HDMI 1.4a (297 Mpix/sec max) 2 x HDMI 1.4a for Multiviewer (297 Mpix/sec max)
Still stores	Up to 100 HD stills available in background, Aux or PIP
Layer effects	<ul style="list-style-type: none"> Borders (hard, soft, halo) and drop shadows Color effects Strobe, H&V flip Luma key PIP moves via Keyframes
Multiviewer	<ul style="list-style-type: none"> Flexible user-definable layouts Monitor all Inputs and Outputs, including Preview and Aux Two outputs Dedicated hardware same as E2 Event Master Processor
Expandability	Linking is available as an upgrade option
HDCP	HDCP compliant
Control	<ul style="list-style-type: none"> Event Master screen management software for PC or MAC Ethernet RJ-45, 1000/100/10 Mbps autosense
Serviceability	<ul style="list-style-type: none"> Field-serviceable I/O and processing cards (not hot-swappable) Hot-swappable dual-redundant power supplies
Dimensions	<ul style="list-style-type: none"> Height: 13.26 cm (5.22 in) - 3 rack mount units Width: 43.2 cm (17 in) without chassis handles, 48.3 cm (19 in) with chassis handles attached Depth: 54 cm (21.33 in) overall
Weight	24 kg / 53 lbs
Power	<ul style="list-style-type: none"> Input power: 100-240 VAC 50/60Hz 700W Dual redundant power supplies (optional) same as E2 Event Master processor
Environmental temperature	0-40° C / 32-104 F

Environmental humidity	0-95% non-condensing
Warranty	3 years parts and labor

A.5 Specifications of EX

EX Specifications

Video inputs	2 card slots, which can be either input or output <ul style="list-style-type: none"> Up to 8 inputs using any of the Event Master input cards Input distribution to other processors via the link cable or a locally installed output card
Video outputs	2 card slots, which can be either input or output <ul style="list-style-type: none"> Up to 8 outputs using any of the Event Master input cards Output sourcing from other processors via the link cable or a locally installed input card
Genlock	Analog reference input on BNC connector <ul style="list-style-type: none"> Blackburst and Bi-level at SD, Tri-level at HD Reference output provided by internal sync generator capable of Bi-level and Tri-level sync signals
Program output	Up to 8 program outputs for destinations created in a linked E2 or S3-4K processor
Scaled AUX outputs	User definable up to 8x 2048 × 1200 at 60 Hz or 2x 4K at 60 Hz Output color correction
Still stores	Up to 100 HD stills available in AUX
Expandability	<ul style="list-style-type: none"> Easily expandable for larger display applications via proprietary links 2 Ex chassis can be linked for standalone operation, or an EX can be linked to either an E2 or an S3-4K.
HDCP	HDCP compliant
Control	<ul style="list-style-type: none"> Event Master screen management software for PC or MAC Ethernet RJ-45, 1000/100/10 Mbps autosense
Serviceability	<ul style="list-style-type: none"> Field-serviceable I/O and processing cards (not hot-swappable)
Dimensions	<ul style="list-style-type: none"> Height: 4.37 cm (1.72 in.) – 1RU rackmount Width: 48.26 cm (19 in.) Depth: 40.41 cm (15.91 in.)
Weight	5.53 kg / 12.2 lbs
Power	<ul style="list-style-type: none"> Input power: 100 – 240 VAC 50/60 Hz 125 W
Warranty	<ul style="list-style-type: none"> 3 years parts and labor

A.6 Specifications of EC-30

Overview

Connectivity	USB connection from Event Master Toolset host computer (OSX or Windows 7 and higher)
Dimensions (HxWxD)	105.4 x 465.6 x 321.0 mm / 4.15 x 18.33 x 12.63 inches
Weight	3.18 kg (7 lbs.)

A.7 Specifications of EC-50

Overview

Connectivity	USB connection from Event Master Toolset, from a control computer DVI input for touchscreen monitor
Dimensions (HxWxD)	244.34 x 511.56 x 610.05 mm / 9.62 x 20.14 x 24.02 inches
Weight	12.33 kg (27.2 lbs)

A.8 Specifications of EC-200

Overview

Features	<ul style="list-style-type: none"> • Robust Linux version of EventMaster Toolset - same user interface used on Mac and PC • Onboard PC running Linux to support a purpose-built version of Event Master toolset, enabling stand-alone usage • Full control over the EventMaster Series switchers • Simultaneous connection of multiple controllers, GUI interfaces, and processors supported on same network. (Redundant backups of control) • 2 internal 15.6-inch wide screen full HD (1,920x1,080) touchscreens with 10 point multi touch • 2 external monitors or touchscreens supported* • High-resolution T-Bar for manual transitions • 36 user-assignable buttons with customizable LCD labels • Dedicated Background layer button • 8 dedicated Layer selection buttons with multi-page functionality (shift pages for destinations with 9 or more layers) • 12 user-definable Destination buttons with multi-page functionality (easily supports all the destinations available in future releases) • Dedicated buttons for transition, live switching, modifying program, transitions, etc. • 5 rotary encoders with wheels for ergonomic pip control and rapid placement of resources • 12 LCD Contextual Display Buttons to support the Syntax Programmer • Tri Axis backlit trackball (based on function), with a very smooth rotary encoder for the third axis and 4 buttons for cursor and position control • 2 separate gigabit Ethernet network interface connections, one for Primary system control, and one for supplemental network control (additional IP address range and mode) • Internal Solid State Hard drive • 5 USB ports for additional accessories such as external touchscreens, mouse, keyboard, thumbdrive, etc. • Script lights, feedback LEDs, and integrated work lights all dimmable • Dust cover included • Custom road case included <p>* Note: The EC-200 DVI-D monitor connections do not support analog output. Digital displays or digital to analog converters are required.</p>
Connectivity	<ul style="list-style-type: none"> • Controls multiple EventMaster Series systems, including E2 and S3-4K • Allows for an external control system to interact over a separate network interface • Two additional DVI outputs for monitors to increase workspace, or add on up to 2 EC-50 for ultimate expansion • Auto-ranging mains input (90-250VAC) • External pointing device and Keyboards supported over USB
Dimensions (HxWxD)	244.34 x 901.19 x 575.36 mm / 9.62 x 35.49 x 22.65 inches
Weight	20.41 kg (45 lbs)

A.9 Specifications of standard connections

Standard connection specifications

DisplayPort (DP)	<ul style="list-style-type: none"> • Per DP 1.1a specification • On DP connector • Formats up to 2,560 × 1,600 at 60 Hz and 3,840 × 1,200 at 60 Hz (30 bits) • 4K/UHD supported: <ul style="list-style-type: none"> - 3,840 × 2,160/23.98/24/25/29.97/30 via 1x DP, 2x DP (L and R half), or 4x DP (quadrants) - 3,840 × 2,160/50/59.94/60 via 2x DP (L and R half) or 4x DP (quadrants) - 4,096 × 2,160/23.98/24/25/29.97/30 via 1x DP, 2x DP (L and R half) or 4x DP (quadrants) - 4,096 × 2,160/50/59.94/60 via 2x DP (L and R half) or 4x DP (quadrants) - 4,096 × 2,400/23.98/24/25/29.97/30/50/59.94/60 via 2x DP (L and R half) or 4x DP (quadrants) • EDID version 1.3 compatible • HDCP version 1.4 compatible
DVI	<ul style="list-style-type: none"> • Per DVI 1.0 specification • DVI Digital video on DVI-I connector • All single-link DVI formats up to 165 MHz • All dual-link DVI formats up to 330 MHz • Maximum H Active: 4,096; Maximum V Active: 3,072 • 4K/UHD Supported: <ul style="list-style-type: none"> - 3,840 × 2,160/23.98/24/25/29.97/30 input via 1x DVI-DL, 2x DVI-SL (L and R half) or 4x DVI-SL (quadrants) - 3,840 × 2,160/50/59.94/60 input via 2x DVI-DL (L and R half) or 4x DVI-SL (quadrants) - 4,096 × 2,160/23.98/24/25/29.97/30 input via 2x DVI-SL (L and R half) or 4x DVI-SL (quadrants) - 4,096 × 2,160/50/59.94/60 input via 2x DVI-DL (L and R half) or 4x DVI-SL (quadrants) - 4,096 × 2,400/23.98/24/25/29.97/30 input via 2x DVI-SL (L and R half) or 4x DVI-SL (quadrants) - 4,096 × 2,400/50/59.94/60 input via 2x DVI-DL (L & R half) or 4x DVI-SL (quadrants) • EDID version 1.3 compatible • HDCP version 1.4 compatible
HDMI	<ul style="list-style-type: none"> • Per HDMI 1.4a specification • On HDMI connector (Type A) • Formats up to 2,560 × 1,600 at 60 Hz and 3,840 × 1,200 at 60 Hz (30 bits) • 4K/UHD Supported: <ul style="list-style-type: none"> - 3,840 × 2,160/23.98/24/25/29.97/30 input via 1x HDMI, 2x HDMI (L and R half) or 4x HDMI (quadrants) - 3,840 × 2,160/50/59.94/60 input via 2x HDMI (L and R half) or 4x HDMI (quadrants) - 4,096 × 2,160/23.98/24/25/29.97/30 input via 1x HDMI, 2x HDMI (L and R half) or 4x HDMI (quadrants) - 4,096 × 2,160/50/59.94/60 input via 2x HDMI (L and R half) or 4x HDMI (quadrants) • EDID version 1.3 compatible • HDCP version 1.4 compatible
SDI	<ul style="list-style-type: none"> • SD/HD/3G SDI (6G ready) on BNC connector • Formats: <ul style="list-style-type: none"> - SD Formats: SD-SDI per SMPTE 259M-C (NTSC/PAL resolution) - HD Formats: HD-SDI per SMPTE 274M, 296M, 2048 - 3G Formats: 3G-SDI per SMPTE 424M, Barcolink • 6G Ready (via future firmware upgrade) • 4K/UHD Supported: <ul style="list-style-type: none"> - 3,840 × 2,160/23.98/24/25/29.97/30 input via 4x HD-SDI (quadrants) - 3,840 × 2,160/50/59.94/60 input via 4x 3G-SDI (quadrants) - 4,096 × 2,160/23.98/24/25/29.97/30 input via 4x HD-SDI (quadrants) - 4,096 × 2,160/50/59.94/60 input via 4x 3G-SDI (quadrants)

A.10 Standard connector pinouts

DisplayPort connector pinouts

The following figure illustrates the DisplayPort connector.

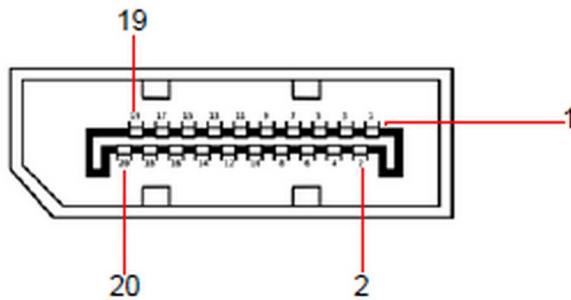

Image A-1
DisplayPort connector

The following table lists the DisplayPort connector pinouts.

DisplayPort connector			
Pin	Signal	Pin	Signal
1	ML_Lane 0 (p)	11	GND
2	GND	12	ML-Lane 3 (n)
3	ML_Lane 0 (n)	13	CONFIG1 (connected to Ground)
4	ML-Lane 1 (p)	14	Config2 (connected to Ground)
5	GND	15	AUX CH (p)
6	ML_Lane 1 (n)	16	GND
7	ML-Lane 2 (p)	17	AUX CH (n)
8	GND	18	Hot Plug Detect
9	ML_Lane 2 (n)	19	Return (return for power)
10	ML_Lane 3 (p)	20	DP_PWR Power for connector (3.3 V, 500 mA)

DVI connector pinouts

The following figure illustrates the DVI connector.

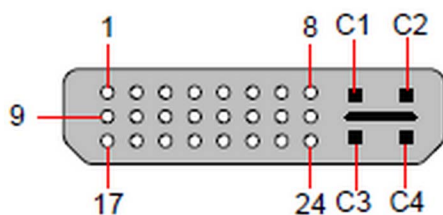

Image A-2
DVI connector

The following tables lists DVI Connector pinouts. Please note:

- T.M.D.S = Transition Minimized Differential Signal
- DDC = Display Data Channel

DVI connector			
Pin	Signal		
1	T.M.D.S. Data 2-	13	T.M.D.S. Data 3+
2	T.M.D.S. Data 2+	14	+5V Power
3	T.M.D.S. Data 2/4 Shield	15	ground (for +5V)

A. Specifications

DVI connector			
Pin	Signal		
4	T.M.D.S. Data 4-	16	Hot Plug Detect
5	T.M.D.S. Data 4+	17	T.M.D.S. Data 0-
6	DDC Clock	18	T.M.D.S. Data 0+
7	DDC Data	19	T.M.D.S. Data 0/5 Shield
8	Analog Vertical Sync	20	T.M.D.S. Data 5-
9	T.M.D.S. Data 1-	21	T.M.D.S. Data 5+
10	T.M.D.S. Data 1+	22	T.M.D.S. Clock Shield
11	T.M.D.S. Data 1/3 Shield	23	T.M.D.S. Clock +
12	T.M.D.S. Data 3-	24	T.M.D.S. Clock -

MicroCross Pins			
Pin	Signal	Pin	Signal
C1	Analog Red Video	C4	Analog Horizontal Sync
C2	Analog Green Video	C5	Analog Common Ground Return
C3	Analog Blue Video		

Ethernet connector pinouts

The following figure illustrates the Ethernet connector.

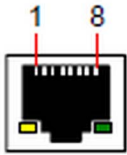

Image A-3
Ethernet connector

The following table lists Ethernet connector pinouts.

Pin	Pair	Color	10/100 Base-T — RJ45 port	1000 Base-T — RJ45 port
			Description	Description
1	3	white/green	TXD+	TX0+
2	3	green	TXD-	TX0-
3	2	white/orange	RXD+	RX0+
4	1	blue	—	TX1+
5	1	white/blue	—	TX1-
6	2	orange	RXD-	RX0-
7	4	white/brown	—	Rx1+
8	4	brown	—	RX1-

HDMI connector pinouts

The following figure illustrates the HDMI connector.



Image A-4
HDMI connector

The following table lists HDMI connector pinouts.

HDMI connector			
Pin	Signal	Pin	Signal
1	TMDS Data2+	11	TMDS Clock Shield
2	TMDS Data2 Shield	12	TMDS Clock-
3	TMDS Data2-	13	CEC
4	TMDS Data1+	14	
5	TMDS Data1 Shield	15	SCL
6	TMDS Data1-	16	SDA
7	TMDS Data0+	17	DDC/CEC/HEC Ground
8	TMDS Data0 Shield	18	+5 v Power (max 50 mA)
9	TMDS Data0-	19	Hot Plug Detect (All Versions) and HEC Data+
10	TMDS Clock+		

B. REMOTE CONTROL PROTOCOL

About this annex

This chapter lists and provides details for the Event Master series processor remote control commands.

B.1 Event Master series processor ASCII remote control

General

The user can remotely control the Event Master series processor via a telnet connection to the unit's IP address.

How to access the Event Master series processor remotely

To access the Event Master series processor remote commands, use the following procedure:

1. In a command prompt window, type a telnet command in the following format:
 `> telnet nnn.nnn.nnn.nnn 9878`
 where the n's represent the unit IP address and 9878 is the port.
2. Press **Enter**
 The command prompt appears.
3. At the command prompt, type a specific Event Master series processor remote control command and press Enter.

ASCII remote commands

This section lists the Event Master series processor remote commands, sorted by name.

ATRN

- Description: Performs an Auto Transition on the currently active destinations. The currently selected Effect type, rate and edge width will be used to transition preview to program.
- Command Format: ATRN <transTime>
- Parameters:
 <transTime> (optional)
 Used to specify a transition time (duration of the transition) in frames. Value ranges from 0 to 1999. A 0 specify a cut transition. Any non-zero value (within range) will override the transition time in the controller. If this argument is not specified, the current transition time known by the controller will be used.
- Examples:
 `> ATRN 200`
 (Transition Preview to Program on currently active destinations in 200 frames)
 `> ATRN 0`
 (Transition Preview to Program immediately. This is a CUT.)
 `> ATRN`
 (Transition Preview to Program using the transition time set in the controller)
- Query Format: N/A
- Query Response: N/A

PRESET

- Description: Preset Settings. For parameter details, see below.
- Command Format: PRESET
- Parameters:
 -s (save preset, 1-1000)
 -r (recall preset, 1-1000)
 -a (recall preset and auto transition, 1-1000)
- Examples:
 `> PRESET -s 1`
 (Save currently selected destinations to preset 1)
 `> PRESET -r 10`
 (Recall preset 10)
 `PRESET -a 10`
 (Recall preset 10 and auto transition)
- Query Format: N/A
- Query Response: N/A

B.2 Event Master series processor JSON RPC remote control

General

JSON (JavaScript Object Notation) is a lightweight format that is used for interchanging data. It is based on a subset of JavaScript language: the way objects are built in JavaScript.

Introduction to JSON

JSON is built on two structures:

- A collection of name/value pairs: In various languages, this is realized as an object, record, struct, dictionary, hash table, keyed list, or associative array.
- An ordered list of values: In most languages, this is realized as an array, vector, list, or sequence.

Here is an example of JSON data:

```
{
  "firstName": "John",
  "lastName": "Smith",
  "address": {
    "streetAddress": "21 2nd Street",
    "city": "New York",
    "state": "NY",
    "postalCode": 10021
  },
  "phoneNumbers": [
    "212 555-1234",
    "646 555-4567"
  ]
}
```

How JSON interacts with Event Master processors

JSON uses JSON RPC (REST based) to interact with the Event Master processors such as E2, S3-4K, and EX. JSON-RPC is a remote procedure call protocol encoded in JSON.

JSON-RPC works by sending a request to a server implementing this protocol. The client in that case is typically software intending to call a single method of a remote system. Multiple input parameters can be passed to the remote method as an array or object, whereas the method itself can return multiple output data as well.

There are JSON RPCs defined to perform tasks on the Event Master processor. User needs to send JSON request through their application or open source application like Postman.

These applications should send request on IP where the Event Master processor is running and fixed port 9999 (Webserver of Event Master processor is running on port 9999).

Postman

Postman is an application that you can use to test the Event Master JSON API.

1. Go to the GetPostman website.
(<https://www.getpostman.com/>)
2. Download the free Postman app.
3. Install Postman on your machine.
4. Launch Postman and follow these steps to send JSON commands to the Event Master processor.
 - a) Select POST from the dropdown next to the URL text box.
 - b) Enter the request URL with port 9999.
 - c) Type "Content-Type" for header and "application/json" as value of this header.
(See <https://www.getpostman.com/docs/requests> for more information on sending requests.)

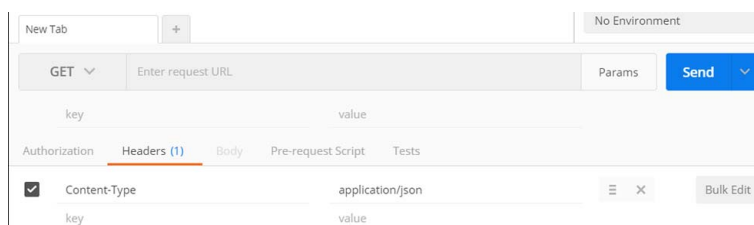

Image B-1
Content-Type and application/json

5. Select **Body** and click on raw from the buttons available below the URL text box.
6. Write the request in the body.

A request is a call to a specific method provided by a remote system. It must contain three certain properties:

- method—a String with the name of the method to be invoked.
- params—an Object or Array of values to be passed as parameters to the defined method.
- id—a value of any type used to match the response with the request to which it is replying.

The receiver of the request must reply with a valid response to all received requests. A response must contain the properties mentioned below.

- result—the data returned by the invoked method.
If an error occurred while invoking the method, this value must be null.
- error—a specified error code if there was an error invoking the method, otherwise null.
- id—the id of the request to which it is responding.

For example: `{"params": {}, "method": "powerStatus", "id": "1234", "jsonrpc": "2.0"}`

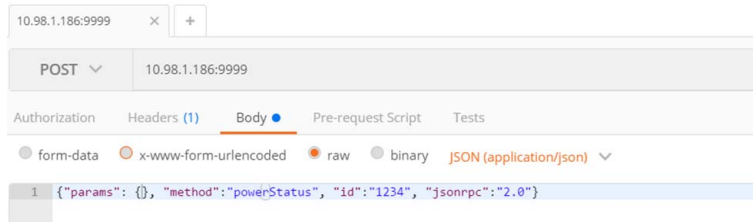

Image B-2
powerStatus API – example

Here, **powerStatus** is the JSON API to be sent.

JSON APIs

Here are some of the JSON APIs defined for controlling the Event Master processor. If you have a master / slave Event Master setup, JSON must be sent to the master unit. For all the requests, this section explains the parameter passed or used in the RPC calls. If the params object is blank that means that API doesn't require a parameter.



Requests are case sensitive.

allTrans

- Definition:
 - It executes the "allTrans" command.
- Request:
 - params: {} - It doesn't require any parameter.
- Response:
 - response: null
 - success: (0=success, anything else is an error)
- Example:
 - `{"params": {}, "method": "allTrans", "id": "1234", "jsonrpc": "2.0"}`

cut

- Definition:
 - It executes the "Cut" command.
- Request:
 - params: {} - It doesn't require any parameter.
- Response:
 - response: null
 - success: (0=success, anything else is an error)
- Example:
 - `{"params": {}, "method": "cut", "id": "1234", "jsonrpc": "2.0"}`

resetFrameSettings

- Definition:
 - Expose ALL reset types on Event Master processor with different options.
- Request:
 - params: {"reset":x},
"x" can be 0 – 5
 - 0: Soft reset.
 - 1: Factory reset.
 - 2: Factory reset (save IP).
 - 3: Factory reset (save IP/EDID).
 - 4: Factory reset (save VPID).
 - 5: Factory reset (Power Down).
- Response:
 - response: null
 - success: (0=success, anything else is an error)
- Example:
 - {"params":{"reset": 0}, "method":"resetFrameSettings", "id":"1234", "jsonrpc":"2.0"}

powerStatus

- Definition:
 - This queries the power plug status of the Event Master processor. (There can be 1 or 2 power slots in Event Master processor).
- Request:
 - params: {} - It doesn't require any parameter.
- Response:
 - response: {FrameId1 :{ PwrStatus1, PwrStatus2},{FrameId2 :{ PwrStatus1, PwrStatus2}
 - PwrStatus1 gives the power status of the 1st slot in Event Master processor with frame id Frameld1, Frameld2.
 - PwrStatus2 gives the power status of the 2nd slot in Event Master processor with frame id Frameld1, Frameld2.
 - 0: Power supply module is not present.
 - 1: Power supply module is present, but there is no power cable.
 - 2: Power supply module is present, and the cable is plugged in, but there is no DC current.
 - 3: Power supply module is present, and everything is OK.
 - success: (0=success, anything else is an error)
- Example:
 - {"params":{}, "method":"powerStatus", "id":"1234", "jsonrpc":"2.0"}

listPresets

- Definition:
 - This queries the list of Presets on a particular destination or on the system.
- Request:
 - params: {"ScreenDest":x , "AuxDest":x},
"x" can be:
 - -2: Do not include any destinations of this type. (Has priority over particular id, if passed as a parameter.)
 - -1: Do not care (All presets). (Has priority over particular id, if passed as a parameter.)
 - 0–999: want to see the presets with the destination this particular id in it or array of ids. Eg. "ScreenDestination":[{"id": 2}, {"id": 3}]
- Response:
 - response: Array of: [{"id": 0, "Name": "Preset3.00", "LockMode": 0, "presetSno": 3.00}, {"id": 1, "Name": "Preset4.00", "LockMode": 0, "presetSno": 4.00}]
 - Response contains the array of presets. Above response contains id, name, lock mode preset serial number of the all the presets.
 - success: (0=success, anything else is an error)
- Example:
 - {"params":{"ScreenDest": 0}, "method":"listPresets", "id":"1234", "jsonrpc":"2.0"}

listDestinationsForPreset

- Definition:
 - Lists the content of a Preset.
- Request:
 - params: {"id":x },
"x" can be:
 - -1: List all Presets.
 - 0-999: list only that specific Preset.
- Response:
 - response: Array of: [{"id": 0, "Name": "Preset3.00", "LockMode": 0, "presetSno": 3.00, "ScreenDest":[{"id": 0}, {"id": 3}], "AuxDest":[{"id": 0}, {"id": 1}]}]
 - Response contains the array of Presets.
 - success: (0=success, anything else is an error)
- Example:
 - { "params":{"id": 0}, "method":"listDestinationsForPreset", "id":"1234", "jsonrpc":"2.0"}

savePreset

- Definition:
 - Creates a Preset on the Event Master processor.
- Request:
 - params: {"presetName": "NewPreset", "ScreenDestination":[{"id": 2}, {"id": 3}], "AuxDestination":[{"id": 1}, {"id": 2}]}
 - "presetName"—Name of the Preset to save.
 - ScreenDestinations—ScreenDest id for the Preset to be created.
 - AuxDestinations—AuxDest id for the Preset to be created.
 - ScreenDestination, AuxDestinations are optional parameters. If user didn't provide it, Preset will be saved for selected destinations.
- Response:
 - response: null
 - success: (0=success, anything else is an error)
- Example:
 - {"params": {"presetName": "NewPreset"}, "method":"savePreset", "id":"1234", "jsonrpc":"2.0"}
 - {"params": {"presetName": "NewPreset", "ScreenDestination":{"id": 0}, "AuxDestination":{"id": 0}}, "method":"savePreset", "id":"1234", "jsonrpc":"2.0"}

Key points regarding Preset, which are same for rename, activate, and delete:

- "id"—id of the preset.
- "presetSno"—preset serial number. User can provide floating point number if required. Eg. "presetSno": 1.01, "presetSno": 1.00, "presetSno": 1, "presetSno": 1.1, "presetSno": 1.10.
Kindly note that 1.1 and 1.10 or 1.00 and 1 are same.
- "presetName"—Name of the preset.

renamePreset

- Definition:
 - Rename a Preset on the Event Master processor. User can rename Preset with id, Preset serial number, or Preset name.
 - Send any one of the parameters to rename Preset.
- Request params:
 - params: {"id": x, "newPresetName": "NewPresetName"}
 - params: {"presetSno": x.y, "newPresetName": "NewPresetName"}
 - params: {"presetName": "OldPresetName", "newPresetName": "NewPresetName"}
 - "newPresetName"—New Preset name to set.
- Response:
 - response: null
 - success: (0=success, anything else is an error)
- Example:
 - {"params": {"id": 0, "newPresetName": " newPresetName "}, "method":"renamePreset", "id":"1234", "jsonrpc":"2.0"}
 - {"params": {"presetName": "NewPreset", "newPresetName": "NewPresetName"}, "method":"renamePreset", "id":"1234", "jsonrpc":"2.0"}
 - {"params": {"presetSno": 1.00, "newPresetName": " newPresetName "}, "method":"renamePreset", "id":"1234", "jsonrpc":"2.0"}

activatePreset

- Definition:
 - Recall a Preset on the Event Master processor. User can recall Preset with id, Preset serial number, or Preset name.
 - Send any one of the parameters to recall Preset.
- Request params:
 - params: {"id": x, "type": x}
 - params: {"presetSno": x.y, "type": x}
 - params: {"presetName": "PresetName"}
 - "type"—0 to recall in preview (default), 1 to recall in program.
 - This is not a mandatory parameter but should be given when the user wants to recall a Preset in program.
- Response:
 - response: null
 - success: (0=success, anything else is an error)
- Example:
 - {"params": {"id": 0, "type": 0}, "method":"activatePreset", "id":"1234", "jsonrpc":"2.0"} //Recall in preview with id 0.
 - {"params": {"presetName": "abc" }, "method":"activatePreset", "id":"1234", "jsonrpc":"2.0"} //Recall in preview with preset name "abc".
 - {"params": {"presetSno": 1.00, "type": 1}, "method":"activatePreset", "id":"1234", "jsonrpc":"2.0"} //Recall in program with presetSno 1.

recallNextPreset

- Definition:
 - Recall the next Preset on the Event Master processor.
 - No parameter is required.
 - Make sure that the user has at least recalled one Preset. Web app recalls the next Preset from the last Preset recalled.
- Request:
 - params: {}
- Response:
 - response: null
 - success: (0=success, anything else is an error)
 - An error is shown if there was no last recalled Preset or if there is no next Preset in the list.
- Example:
 - {"params": {}, "method":"recallNextPreset", "id":"1234", "jsonrpc":"2.0"}

deletePreset

- Definition:
 - Delete a Preset on the Event Master processor.
 - User can delete Preset with id, Preset serial number, or Preset name.
 - Send any one of the parameters to delete Preset.
- Request:
 - params: {"id": x}
 - params: {"presetSno": x.y}
 - params: {"presetName": "PresetName"}
- Response:
 - response: null
 - success: (0=success, anything else is an error)
- Example:
 - {"params": {"id": 1}, "method":"deletePreset", "id":"1234", "jsonrpc":"2.0"}
 - {"params": {"presetSno": 1.00}, "method":"deletePreset", "id":"1234", "jsonrpc":"2.0"}
 - {"params": {"presetName": "Preset 5.00"}, "method":"deletePreset", "id":"1234", "jsonrpc":"2.0"}

listDestinations

- Definition:
 - This API lists all the destinations with properties such as layers, outputs, id, size, and name.
- Request:
 - params: {"type": x}
 - o 0—Show all the destinations.
0 is the default value for the type parameter.
 - o 1—Only screen destinations.
 - o 2—Only aux destinations.
- Response:
 - response: Array of : {"ScreenDestination":[{"id": 0, "Name": "Dest1", "HSize": 3840, "VSize": 1080, "Layers": 1, "DestOutMapColl":[{"id": 0 "DestOutMap":[{"id": 0, "Name": "Out1", "HPos": 0, "VPos": 0, "HSize": 1920, "VSize":1080, "Freeze": 0}, {"id": 1, "Name": "Out2", "HPos": 1920, "VPos": 0, "HSize": 1920, "VSize":1080, "Freeze": 1}]}]}], "AuxDestination":[{"id": 0, "AuxStreamMode": 4}, {"id": 1, "AuxStreamMode": 4}]}
 - success: (0=success, anything else is an error)
- Example:
 - {"params": {"type": 0}, "method":"listDestinations", "id":"1234", "jsonrpc":"2.0"}

listSources

- Definition:
 - This API lists all the input sources with properties.
- Request:
 - params: {"type": x}
 - o 0—Show all the input sources.
0 is the default value for the type parameter.
 - o 1—Only background sources.
- Response:
 - response: Array of : {"id": 0, "Name": "InSource1", "HSize": 3840, "VSize": 1080, "SrcType": 0, "InputCfgIndex": -1, "StillIndex": 0, "DestIndex": -1, "UserKeyIndex": -1, "Mode3D": 0, "Freeze": 1, "Capacity": 2, "InputCfgVideoStatus": 4}
 - success: (0=success, anything else is an error)
- Example:
 - {"params": {"type": 0}, "method":"listSources", "id":"1234", "jsonrpc":"2.0"}

listContent

- Definition:
 - This API shows the content of a screen destination.
- Request:
 - params: {"id": x}
 - "id"—Screen destination index.
- Response:
 - response: { "id": 0, "Name": "ScreenDest1", "BGLyr": [{"id": 0, "LastBGSourceIndex": 0, "BGShowMatte": 0, "BGColor": [{"id": 0, "Red": 0, "Green": 0, "Blue": 0}], {"id": 1, "LastBGSourceIndex": 0, "BGShowMatte": 0, "BGColor": [{"id": 0, "Red": 0, "Green": 0, "Blue": 0}]}], (0 = PGM Background, 1 = PVW Background) "Layers": [{"id": 0, "LastSrcIdx": 0, "HPos": 0, "VPos": 0, "HSize": 400, "VSize": 300, "PvwMode": 0, "PgmMode": 0, "Freeze": 0, "FlexZOrder": 0, "LayerTrans": [{"id": 0, "TransTime": 30, "TransPos": 0}, {"id": 1, "TransTime": 30, "TransPos": 0}], "3D": "Yes", "Freeze": 0, "Capacity": 2}]}
 - id—index of screen destination.
 - Name—Name of ScreenDestination.
 - BGLayer—There are 2 bglayer , one in program and one in preview. Hence, showing Index of background on screen destination.
 - LastBGSourceIndex—This is -1 if no background is dropped, else this is index of last background dropped on screen destination.
 - BGShowMatte—This is if BG to be matte or not.
 - BGColor—This is background color.
 - Layers—Lists layers on screen destination with its properties.
 - Transition—This property of screen destination contains the transition time (from time to move from preview to program).
 - success: (0=success, anything else is an error)
- Example:
 - {"params": {"id": 0}, "method": "listContent", "id": "1234", "jsonrpc": "2.0"}

3dControl

- Definition:
 - This API provides the option to modify 3d Controls.
- Request:
 - params: {"id" : id, "type": x, "syncSource": y, "syncInvert": z}
 - id – Index of the input config.
 - type – "x" can be: 0 – Type Off. 0 is the default value for the type parameter. 1 – Type Sequentia.
 - syncSource – "y" can be: 1 – Mimin Din 1, 2 – Mimin Din 2, 3 – Mimin Din 3, 4 – Mimin Din 4. Default vale is 1.
 - syncInvert – "z" can be: 0 – Type Off. 0 is the default value for the syncInvert. 1 – Type Invert.
 - To reset, do not provide any parameter except "id".
- Response:
 - response: {"id": 0, "Name": "InSource1", "HSize": 3840, "VSize": 1080, "Src-Type": 0, "InputCfgIndex": -1, "StillIndex": 0, "DestIndex": -1, "UserKeyIndex": -1, "Mode3D": 0, "Freeze": 1, "Capacity": 2, "InputCfgVideoStatus": 4}
 - success: (0=success, anything else is an error)
- Example:
 - {"params": {"id": 1, "type": 0, "syncSource": 1, "syncInvert": 0}, "method": "3dControl", "id": "1234", "jsonrpc": "2.0"}

changeContent

- Definition:
 - This API changes the content of a screen destination by putting background and layers in it.
- Request:
 - params:

```
{
  "id":0,
  "BGLyr": [
    {
      "id":0,
      "LastBGSourceIndex":0,
      "BGShowMatte":0,
      "BGColor": [
        {
          "id":0,
          "Red":0,
          "Green":0,
          "Blue":0
        }
      ],
      {
          "id":1,
          "LastBGSourceIndex":0,
          "BGShowMatte":0,
          "BGColor": [
            {
              "id":0,
              "Red":0,
              "Green":0,
              "Blue":0
            }
          ]
        }
      ],
      "Layers": [
        {
          "id":0,
          "LastSrcIdx":0,
          "Window": {
            "HPos":0,
            "VPos":0,
            "HSize":400,
            "VSize":300
          },
          "Source": {
            "HPos":0,
            "VPos":0,
            "HSize":1920,
            "VSize":1080,
            "Mask": {
              "Left":0.01,
              "Right":10.1,
              "Top":0.0,
              "Bottom":0.0
            },
            "PvwMode":1,
            "PgmMode":0,
            "Freeze":0,
            "PgmZOrder":0,
            "PvwZOrder":0
          }
        }
      ]
    }
  ],
  "id":0,
  "method":"changeContent",
  "id":"1234",
  "jsonrpc":"2.0"
}
```

 - id—Screen destination index.
 - BGLayer—Background layer index, Last source index of background.
 - Layers—Layer information.
 - Window—Layer window size.
 - Source—Source info and size.
 - Mask—Crop the visible part of the layer.
 - PvwMode—Set 1 if you want the content in preview. (Default)
 - PgmMode—Set 1 if you want the content in program.
- Response:
 - response: null
 - success: (0=success, anything else is an error)
- Example:

```
{
  "params": {
    "id":0,
    "BGLyr": [
      {
        "id":0,
        "LastBGSourceIndex":0,
        "BGShowMatte":0,
        "BGColor": [
          {
            "id":0,
            "Red":0,
            "Green":0,
            "Blue":0
          }
        ],
        {
          "id":1,
          "LastBGSourceIndex":0,
          "BGShowMatte":0,
          "BGColor": [
            {
              "id":0,
              "Red":0,
              "Green":0,
              "Blue":0
            }
          ]
        }
      ],
      "Layers": [
        {
          "id":0,
          "LastSrcIdx":0,
          "Window": {
            "HPos":0,
            "VPos":0,
            "HSize":400,
            "VSize":300
          },
          "Source": {
            "HPos":0,
            "VPos":0,
            "HSize":1920,
            "VSize":1080,
            "Mask": {
              "Left":0.01,
              "Right":10.1,
              "Top":0.0,
              "Bottom":0.0
            },
            "PvwMode":1,
            "PgmMode":0,
            "Freeze":0,
            "PgmZOrder":0,
            "PvwZOrder":0
          }
        }
      ]
    },
    "method":"changeContent",
    "id":"1234",
    "jsonrpc":"2.0"
  }
}
```

freezeDestSources

- Definition:
 - This API Freezes/Unfreezes the sources.
- Request:
 - params: {"type": x, "id": y, "screengroup": z, "mode": 0/1}
 - type—type of source.
 - 0—Input source.
 - 1—Background source.
 - 2—ScreenDestination.
 - 3—AuxDestination.
 - id—Index of the source.
 - id—Index of the source.
 - Screengroup—For future use. Always set to 0.
 - Mode—0 : UnFreeze, 1 : Freeze.
- Response:
 - response: null
 - success: (0=success, anything else is an error)
- Example:

```
{
  "params": {
    "type": 0,
    "id": 0,
    "screengroup": 0,
    "mode": 1
  },
  "method":"freezeDest-Source",
  "id":"1234",
  "jsonrpc":"2.0"
}
```

listStill

- Definition:
 - This API lists all the stills with properties such as id, Name, H/V size, LockMode, StillState, PngState, File size.
- Request:
 - params: {}
- Response:
 - response: `Array of [{"id":0,"Name":"StillStore1","LockMode":0,"HSize":{"Min":0,"Max":99999,"$t":1920},"VSize":{"Min":0,"Max":99999,"$t":1080},"StillState":{"Min":0,"Max":4,"$t":3},"PngState":{"Min":0,"Max":2,"$t":0},"FileSize":{"Min":0,"Max":100000,"$t":9331.2}]`
 - id—Index of still store.
 - Name—Name of still store.
 - LockMode—For future use. Always set to 0.
 - H/V size—Horizontal and vertical size, Min, max and current value. It shows the current value.
 - StillState—This tells user if the still is currently being captured or not, or if it is getting deleted.
 - PngState—The “PNG” for stills are for the thumbnails we capture for the stills.
 - FileSize—Size of the file created in KBs.
 - success: (0=success, anything else is an error)
- Example:
 - {"params": {}, "method":"listStill", "id":"1234", "jsonrpc":"2.0"}

deleteStill

- Definition:
 - This API deletes a still.
- Request:
 - params: {"id": x}
 - id—Index of still.
- Response:
 - response: null
 - success: (0=success, anything else is an error)
- Example:
 - {"params":{"id": 0}, "method":"deleteStill", "id":"1234", "jsonrpc":"2.0"}

takeStill

- Definition:
 - This API creates/overwrites a still.
- Request:
 - params: {"type": x, "id": y, "file": z}
 - type—0 for input source, 1 for BG source.
 - Id—Index of the source. If the source id of the destination is provided, no still is created and an error is shown.
 - File—still file id. If you pass “file”: 5, this creates StillStore6.
- Response:
 - response: null
 - success: (0=success, anything else is an error)
- Example:
 - {"params":{"type":0, "id": 1, "file": 5}, "method":"takeStill", "id":"1234", "jsonrpc":"2.0"}
 - This creates a still from input source id 1 as StillStore6.

getFrameSettings

- Definition:
 - This API shows system information, including all the frames information.
- Request:
 - params: {}

listAuxContent

- Definition:
 - This API shows Aux destination information.
- Request:
 - params: {"id" : x}
 - Id—Index of the Aux destination.
- Response:
 - response: {"id":0,"Name":"AuxDest1","PvwLastSrcIndex":0,"PgmLastSrcIndex":0}
 - id—Index of Aux destination.
 - Name—Name of Aux destination.
 - PvwLastSrcIndex—Input/Background source index in the preview area.
 - PgmLastSrcIndex—Input/Background source index in the program area.
 - success: (0=success, anything else is an error)
- Example:
 - {"params": {"id": 0}, "method":"listAuxContent", "id":"1234", "jsonrpc":"2.0"}

changeAuxContent

- Definition:
 - This API changes the source in the Aux destinations.
- Request:
 - params: {"id":x , "Name": "AuxDest1" , "PvwLastSrcIndex": y , "PgmLastSrcIndex": z}
 - id—Index of the Aux destination.
 - Name—Name of Aux destination. (Optional paramter)
 - PvwLastSrcIndex—Input/Background source index to set in Aux destination in the preview area.
 - PgmLastSrcIndex—Input/Background source index to set in Aux destination in the program area.
- Response:
 - response: null
 - success: (0=success, anything else is an error)
- Example:
 - {"params": {"id":0 , "Name": "AuxDest1" , "PvwLastSrcIndex": 6 , "PgmLastSrcIndex": 1}, "method":"changeAuxContent", "id":"1234", "jsonrpc":"2.0"}

Subscription and Un-Subscription

When a subscription is done from a JSON-based application, a notification is sent to the ip port where the application is running when there is change for which the user has subscribed.

Actual notification is sent asynchronously as an HTTP Post, with the following structure: {result: {method: "notification",notificationType: "ScreenDestChanged",change: { add: [2], remove: [], update: [0, 1, 2] }}}.

The change field contains the XmlId(s) of the screens that were added/removed or updated.



All subscriptions are lost once the Event Master processor is restarted, and they must be subscribed again if required.

subscribe

- Definition:
 - User can use this API to subscribe to change events in the Event Master processor.
 - Once subscribed, the API sends a notification in the form of an HTTP Post to the Url: `http://hostname:port/`.
- Request:
 - `params: {"hostname": hostname, "port": port, "notification" : notificationType[]}`
 - `hostname`—Hostname or IP Address to which the notifications are sent.
 - `port`—TCP port to which the notification are posted.
 - `notificationTypes`—an array of notifications to which a user wants to subscribe.
 - `ScreenDestChanged`
 - `AUXDestChanged`
 - `FrameChanged`
 - `NativeRateChanged`
 - `InputCfgChanged`
 - `SourceChanged`
 - `BGSourceChanged`
 - `PresetChanged`
 - `StillChanged`
 - `OutputCfgChanged`
- Response:
 - `response: {"method": "subscribe"}`
 - `success: (0=success, anything else is an error)`
- Example:
 - `{"params": {"hostname" : "192.168.247.131", "port": "3000", "notification" : ["ScreenDestChanged", "AUXDestChanged"]}, "method": "subscribe", "id": "1234", "jsonrpc": "2.0"}`

unsubscribe

- Definition:
 - User can use this API to remove the subscription for the given hostname, port, and notificationType.
- Request:
 - `params: {"hostname": hostname, "port": port, "notification" : notificationType[]}`
 - `hostname`—Hostname or IP Address from which the subscription is to be removed.
 - `port`—TCP port.
 - `notificationTypes`—an array of notifications to which a user wants to subscribe.
 - `ScreenDestChanged`
 - `AUXDestChanged`
 - `FrameChanged`
 - `NativeRateChanged`
 - `InputCfgChanged`
 - `SourceChanged`
 - `BGSourceChanged`
 - `PresetChanged`
 - `StillChanged`
 - `OutputCfgChanged`
- Response:
 - `response: {"method": "unsubscribe"}`
 - `success: (0=success, anything else is an error)`
- Example:
 - `{"params": {"hostname" : "192.168.247.131", "port": "3000", "notification" : ["ScreenDestChanged", "AUXDestChanged"]}, "method": "unsubscribe", "id": "1234", "jsonrpc": "2.0"}`

C. TROUBLESHOOTING

C.1 Troubleshooting List

Problem solving

Problem	Possible cause	Remedy
Event Master unit doesn't start	The Power supplies are not connected to a valid power source	Make sure that at least one power supply is connected to a valid power source.
		Make sure that the supplies are well inserted in their slots. Remove the power cord and apply a little pressure by using the handle until both supplies are fully inserted.
	Corrupt configuration data is in the system.	Press and hold the SEL and ESC keys while applying power to the unit. Release these keys when a menu appears asking to Factory Reset the unit. Perform the Factory Reset and the unit will boot normally.
One of the Power Supplies is not coming on	If the input AC power LED on the Power supply is off, then the supply is not receiving a valid AC power	Check the AC power cable and ensure that the unit is connected to a valid power source.
	If the input AC power LED is green but the output DC power LED is off or if the status LED is amber, then the supply is not producing valid DC output power	If the other Power supply is functioning normally, swap it with the supply that doesn't work. If the problem follows the power supply, then the you need to replace the power supply. If the problem stays with the slot, then the fault possibly lies with the System Power card. Contact your local Barco customer service support for further assistance.
All or most images are unstable or/and noisy	Temperature issue	Operating ambient temperature must be higher than 0°C (32°F) and lower than 40°C (104°F).
		Run the board diagnostics in order to detect errors.
		Leave sufficient front and rear clearance to ensure that airflow through the Event Master unit is not restricted.
		Clean the EMI filter, if an EMI filter is present.
A specific image is unstable or/and noisy	Bad Input, output, VPU or motherboard card	Run the board diagnostics in order to detect errors. If the board diagnostics doesn't detect any errors proceed to the next step.
		From the GUI change the output card from which the image is derived. If the problem persists, then the issue is not with the output card. Continue by switching the input source to a different input card. If the issue persists then the issue is not with input card. If the input and output cards have been ruled out, then the issue is either with a VPU card or with the motherboard. In this case, contact your Barco customer service support for further assistance.
The Event Master unit and the PC running the GUI don't communicate	Cabling/network switch issue	Check all of the Ethernet cables and verify that they are plugged in. If you are using a network switch verify that is on and is operating properly.
	Wrong IP address	IP address is not within your LAN range.
		Conflict between network addresses: Check if the Event Master unit network address is not already in use by another device on the local network.
		DHCP is not enabled.
When the PC running Event Master Toolset Software is connected directly with an Event Master unit, the dynamic configuration (DHCP) doesn't work.	There is no DHCP server in this configuration	You need to disable the DHCP option and enter a static network address compatible with the PC running the Event Master control software (range, Subnet mask,...).

C. Troubleshooting

Problem	Possible cause	Remedy
Event Master unit constantly reboots after a software upgrade	Invalid upgrade (deployment or defective installation)	Press and hold the SEL and ESC keys simultaneously until the front panel shows the choice of performing a factory reset or continuing. Performing a factory reset will allow the Event Master unit to boot normally. If the problem persists, contact you local Barco customer service support for further assistance.
Can't read or write to or from the USB drive	Incorrect USB format or bad USB	Ensure that your flash drive is formatted to use the FAT32 file system. If you can't access the USB from a PC, then you have a faulty USB drive.
The front panel display screen is too dark	display brightness	Use the "VFD brightness" sub-menu in the System menu to adjust the intensity of the front panel vacuum fluorescent display (VFD) screen.
The unit is not responding to any front panel button presses.	Front panel is locked	To unlock the front panel, press and hold the SEL and ESC buttons simultaneously for 3 seconds. When the panel is unlocked, the display screen displays the Status menu.
After factory reset, the IP address is lost	Wrong mode of the factory reset command was used	Use the "Factory Reset, Save IP" choice in the "factory reset" sub-menu when you perform a factory reset.
Unable to perform web upgrade	Unable to perform web upgrade	Make sure Event Master unit connection with the LAN is available.
		Make sure there is an internet access in the LAN

D. THIRD PARTY SOFTWARE ACKNOWLEDGEMENTS

About this annex

This chapter lists the third-party software components. The third-party software components are reusable software components developed to be either freely distributed or sold by an entity other than the original vendor of the development platform.

Overview

- Third Party Software list

D.1 Third Party Software list

List and short description

The products and software applications described in this manual make use of one or more of the following third party software items:

- **Boost:** Boost software is distributed under the Boost Software License, Version 1.0, http://www.boost.org/LICENSE_1_0.txt
- **Qt:** The Qt GUI Toolkit is Copyright (C) 2015 Digia Plc and/or its subsidiary(-ies).
Contact: Digia Plc (<http://www.qt.io/about-us/>).
Qt is available under the LGPL version 2.1 (GNU Lesser General Public License version 2.1).
- **XFree86:** is a trademark of The XFree86 Project, Inc.
- **X11(TM) and X Window System(TM):** is a trademark of The XFree86 Project, Inc.
- **Xorg:** Xorg is copyright software, provided under licenses that permit modification and redistribution in source and binary form without fee. Xorg is copyright by numerous authors and contributors from around the world. Licensing information can be found at <http://www.x.org>. Refer to the source code for specific copyright notices.
- **dfu-util:** Licensed under the GNU General Public License, Version 2
<http://www.gnu.org/licenses/old-licenses/gpl-2.0.html>
Source available from <http://dfu-util.gnumonks.org/>
- **lib-usb-1.0.dll:** Licensed under the GNU GPL Public License Version 2
A component of MinGW whose license can be found here: <http://www.mingw.org/license>
- **LPCScrypt and image_manager executables:** are copyright software, provided under license by NXP SEMICONDUCTORS USA, INC. that permit redistribution in binary form without fee as part of supporting software for products using devices manufactured by NXP.
The source code for the components of the Software and Separate Files are available from NXP and can be obtained from <http://www.lpcware.com/lpcxpresso/downloads/source>.

E. WARRANTY

About this annex

This chapter gives an overview of Warranty and conditions of RMA concerning the Event Master devices.

E.1 About Warranty and RMA

Warranty

All video products are designed and tested to the highest quality standards and are backed by a full 3-year parts and labor warranty. Warranties are effective upon delivery date to customer and are non-transferable. Barco warranties are only valid to the original purchaser/owner. Warranty related repairs include parts and labor, but do not include faults resulting from user negligence, special modifications, lightning strikes, abuse (drop/crush), and/or other unusual damages.

The customer shall pay shipping charges when unit is returned for repair. Barco will cover shipping charges for return shipments to customers.

Return Material Authorization (RMA)

RMA Conditions are listed below:

1. Prior to returning any item, you must receive a Return Merchandise Authorization (RMA) number.
2. All RMA numbers must appear on their return-shipping label.
3. RMA numbers are valid for ten (10) days from issue date.
4. All shipping and insurance charges on all RMAs must be prepaid by the customer.

INDEX

A

About 8
 User Guide 8
 About Event Master unit 7
 About Setup menu 77
 About Status menu 76
 About the System menu 78
 About Warranty and RMA 586
 Add destination 143
 Add Input 121
 Add Output 133
 Address 545
 Adjustment area 114
 Adjustment area (Programming) 194
 Application 1: Double Screen Configuration — Control Software Operation 289
 ASCII remote control 566
 ASCII commands 566
 Introduction 566
 Auto add all inputs 120
 Auto add live inputs 120
 Auto add Outputs 132
 Auto create all inputs 120
 Auto create live inputs 120
 Auto create Outputs 132

B

Background configuration 127, 206
 Configuration Menu (Adjustment area) 127
 Programming Menu (Adjustment area) 206
 Basic information 7
 Black Invalid 79

C

Configuration Menu 106, 108, 110, 113–115, 117, 127, 130, 138, 156
 Adjustment area 114
 Adjustment area (Background Configuration) 127
 Adjustment area (Destination Configuration) 138
 Adjustment area (Input Configuration) 117
 Adjustment area (Output Configuration) 130
 Adjustment area (Unit Configuration) 115
 Linking 156
 Network resource area 108
 System diagram area 110
 System modifier area 113
 Configuration Menu (Example 1: Double Screen Configuration) 290
 Control overview 34
 Controller configuration 339
 EC-30 controller connection 339
 Controller Configuration 337–338, 340–344
 Assigning resources to the desk 344
 EC-200 controller connection 341
 EC-50 controller connection 340
 General 338
 Lights 343
 Touch screen calibration 342
 Controller Menu 224
 Controller Operation 347–348, 352–360, 362, 367
 Additional direct access and functionality 367
 EC-200 Philosophy 360
 Function Button For Syntax 362
 General Overview 348
 How to select destinations 352
 How to use assign Buttons 355
 How to use the Contextual Display Buttons 359
 How to use the Layer buttons 353
 How to use the page arrow buttons 356
 How to use the T-bar 358
 How to use transition buttons 357

What are Layer executers? 354
 Controller orientation 309–310, 312–335
 Assign buttons with contextual displays 322
 Contextual Display Button Group (EC-200 only) 329
 Description 310
 Destinations buttons 320
 Direct Selection Button Group and Barco Eye Button (EC-200 only) 326
 EC-200 backside 317
 EC-200 front panel 316
 EC-30 backside 313
 EC-30 front panel 312
 EC-50 backside 315
 EC-50 front panel 314
 Future Expansion Button Group (EC-200 only) 325
 Layer buttons 321
 Live Function Button Group (EC-200 only) 331
 Num Pad Button Group (EC-200 only) 330
 Panel Lock button (EC-200 only) 334
 Rotary Encoders (EC-200 only) 333
 Save button (EC-200 only) 335
 Syntax Entry Button Group (EC-200 only) 328
 System Function Button Group (EC-200 only) 327
 T-Bar 323
 Touch screen 319
 Trackball (EC-200 only) 332
 Transition buttons 324
 Use of color 318
 Controls 105
 CPU Module 521

D

Dest Group configuration 203
 Programming Menu (Adjustment area) 203
 Destination configuration 138
 Configuration Menu (Adjustment area) 138
 Destination groups 203
 Programming Menu 203
 Adjustment area (Dest Group configuration) 203
 Diagnostics 87
 Diagram area (Programming) 187
 display brightness 86
 Download of Event Master Toolset Software 100
 Dual Link DVI Input Card 53

E

E2 Maintenance 381, 383–384, 386–387, 389–390, 393–395, 397, 399, 401–402, 404–407, 409, 411, 413, 415, 419, 422, 425, 427, 429, 431, 433–434, 438, 442–446, 473, 479
 1RU Fan Cable 438
 1RU Fan Tray 395
 3RU Fan Cable 434
 3RU Fan Tray 394
 Bottom Panel 406
 CPU Module 411
 Ethernet Cable 433
 Front Brackets 393
 Front Cover Assembly 390
 Front Panel Board 402
 Front Panel Knob 399
 Front Panel Mount 401
 Front Rack-Ears 443, 479
 Genlock Assembly 419
 Genlock Cable 431
 I/O and Link Cards 387
 Keyboard Cable 429
 Motherboard Fan 446
 Power Supply 413
 Process Overview 384
 Rear I/O, VPU and Link card Heatsink Fan 389

- Rear Rack Ears 442
- Solid-State Memory 407
- Spare parts serviceable by all users 386
- System Battery 409
- System-Power Board 415
- Top Card Guide 445
- Top Cover 444
- Unit Overview 383
- USB Cable 422
- USB Extension Cable 425, 473
- VFD Cable 427
- VFD Display Assembly 404
- VFD Display Filter 405
- VPU Card(s) 397
- EC-200 CPU 351
 - Reboot 351
- EC-200 Maintenance 537
- EC-30 Maintenance 531
- EC-50 Maintenance 533
- EM GUI orientation 97
- Environment conditions 36
- Environmental information 541-543
 - Disposal information 542
 - RoHS compliance 543
- Ethernet settings 84
- Event Master Cards 515
 - Input cards 515
 - DP/HDMI Input card 515
 - DVI Input card 515
 - SDI Input card 515
 - Output cards 515
 - DP Output card 515
 - DVI Output card 515
 - HDMI Output card 515
 - SDI Output card 515
 - VPU card 515
- Event Master controllers features 29
- Event Master devices overview 20
- Event Master series processors features 24
- Event Master Toolset Software software version 36
- Event requirements 286
- EX Maintenance 511-514
 - Process Overview 513
 - Spare parts serviceable by all users 514
 - Unit Overview 512
- Expansion Link card 68

F

- Firmware upgrade 349
 - EC-200 349
 - Settings Menu 349
 - Web App 349
- Firmware Upgrade 94
- Front panel 44
- Front Panel Menu orientation 71
- Front Panel menu tree 73
- Function Button 362, 364-371
 - Adjust 369
 - All Dest 369
 - All Layer 369
 - All Trans 371
 - Barco Eye 370
 - Capture Still 370
 - Clear 369
 - Cue 366
 - Destination 362
 - Device 365
 - HELP Err 367
 - Keyboard 371
 - Layer 362
 - Layout 367
 - Live 370
 - Modify PGM 370
 - Panel lock 371
 - Preset 365

- PVW Trans 369
- Save All 371
- Save PGM 368
- Screens 367
- Source 364
- T-Bar Disable 370
- Time 366
- User Key 365

G

- General 19
- General considerations 16
- General operation example 285
- General requirements 99
- Global Transition Rate/Trans/Cut 215
 - Programming Menu (Adjustment area) 215

H

- Hardware orientation 43
- Hazardous Chemicals 17
- HDMI Output Card 62
- HDMI/DisplayPort Input Card 55
- How to swap Z order 195

I

- Important safety instructions 17
- Initial inspection 37
- Input Configuration 117
 - Configuration Menu (Adjustment area) 117
- Installation requirements 36
- Introduction 8, 12
 - fonts 12
 - pictures 12
 - symbols 12
 - User Guide 8

J

- JSON RPC remote control 567
 - API: Application Programming Interface 567
 - Introduction 567
 - JSON RPC commands 567
 - Data interchange format 567
 - JSON: JavaScript Object Notation 567
 - RPC: Remote Procedure Call 567

L

- Layer configuration 195
 - Programming Menu (Adjustment area) 195
- Layer Modifier area (Programming) 190
- Layout area (Multiviewer Setup page) 218
- Linking 156
 - Configuration Menu 156
- Lock front panel 91

M

- Maintenance 381, 449, 511, 531, 533, 537
 - E2 381
 - EC-200 537
 - EC-30 531
 - EC-50 533
 - EX 511
 - S3 449
- Maintenance actions 373-379
 - E2 374
 - EC-200 379
 - EC-30 377
 - EC-50 378
 - EX 376

- S3 375
 - Mechanical check 39
 - Modifier area (Multiviewer Setup page) 220
 - Motherboard Fansink 529
 - Motherboard removal 524
 - Chassis elements 524
 - Rear-panel elements 524
 - Move 196
 - Multiviewer (MVR) Menu 216
 - Multiviewer Menu 217–218, 220–223
 - Adjustment area 221
 - Adjustment area (Output Color) 222
 - Adjustment area (Window adjustment) 223
 - Layout area 218
 - Modifier area 220
 - Resource area 217
 - Multiviewer Menu (Example 1: Double Screen Configuration) 306
 - Multiviewer Output Color 222
 - Multiviewer Menu (Adjustment area) 222
 - Multiviewer Setup page 221
 - Multiviewer Menu (Adjustment area) 221
 - Multiviewer Window adjustment 223
 - Multiviewer Menu (Adjustment area) 223
- N**
- Network resource area 108
 - Notice on safety 16
- O**
- Output configuration 130
 - Configuration Menu (Adjustment area) 130
- P**
- Power Supply 519
 - Power-up initialization 72
 - Preliminary 287
 - Presentation System overview 35
 - Presets configuration 210
 - Programming Menu (Adjustment area) 210
 - Preventative 373
 - Maintenance actions 373
 - Production 545
 - Programming 194
 - Programming Menu (Adjustment area) 194
 - Programming Menu 173–174, 187, 190, 194–195, 203, 206, 208, 210, 213, 215
 - Adjustment area 194
 - Adjustment area (Background configuration) 206
 - Adjustment area (Dest Group configuration) 203
 - Adjustment area (Global Transition Rate/Trans/Cut) 215
 - Adjustment area (Layer configuration) 195
 - Adjustment area (Presets configuration) 210
 - Adjustment area (Source adjustment) 213
 - Adjustment area (User keys configuration) 208
 - Diagram area 187
 - Layer Modifier area 190
 - Resources area 174
 - Programming Menu (Example 1: Double Screen Configuration) 295
- Q**
- Quad Channel DisplayPort Output Card 60
- R**
- Rack-Mount Procedure 40
 - Rear panel 46
 - Reboot 351
 - EC-200 CPU 351
 - Record of changes 9
 - Remote Control Protocol 565
 - Remove destination 144
 - Remove input 121
 - Remove output 133
 - Resource area (Multiviewer Setup page) 217
 - Resources area (Programming) 174
 - Restoring Factory Default Settings 93
- S**
- S3 Maintenance 449, 451–454, 456–457, 460–461, 465–466, 468–470, 475–476, 480–482, 484, 486, 489, 491–492, 494, 496–497, 501, 503, 506, 508
 - 3RU Fan Cable 503
 - 3RU Fan Tray 461
 - CPU Module 492
 - Ethernet Cable 506
 - Front Brackets 460
 - Front Panel Board 466
 - Front Panel Mount 465
 - Genlock Assembly 476
 - Genlock Cable 508
 - I/O, Link and VPU Cards 454
 - Keyboard Cable 501
 - Link Card Interposer 491
 - Motherboard Fan 482
 - Power Interposer Assembly 484
 - Power Supply 475
 - Power Supply Guide 486
 - Process Overview 452
 - Rear I/O, VPU and Link card Heatsink Fan 456–457
 - Side support plate 489
 - Solid-State Memory 494
 - Spare parts serviceable by all users 453
 - System Battery 496
 - Top Card Guide 481
 - Top Cover 480
 - Unit Overview 451
 - USB Cable 470
 - VFD Cable 497
 - VFD Display Assembly 468
 - VFD Display Filter 469
 - S3Maintenance 463, 478
 - Front Panel Knob 463
 - Rear Rack Ears 478
 - Safety 15, 17
 - Hazardous Chemicals 17
 - Safety Data Sheet (SDS) 17
 - Safety Data Sheet (SDS) 17
 - Save All 95
 - Screen layout presentation 103
 - SDI Input Card 51
 - SDI Output Card 63
 - Service 381, 449, 511, 531, 533, 537
 - E2 381
 - EC-200 537
 - EC-30 531
 - EC-50 533
 - EX 511
 - S3 449
 - Servicing 532, 534, 538
 - Settings Menu 225, 230–231, 235–236, 238, 240–242
 - Web App area 230
 - Web App area (Contact us) 241
 - Web App area (Dashboard) 231
 - Web App area (Follow us) 242
 - Web App area (Help) 240
 - Web App area (Tools > Backup & Restore) 238
 - Web App area (Tools > Manage Software) 236
 - Web App area (Tools) 235
 - Soft-Off button 350
 - EC-200 GUI 350
 - power down 350
 - power off 350
 - Software installation 101
 - Software version 36
 - Source adjustment 213

- Programming Menu (Adjustment area) 213
 - Specifications 547
 - Specifications of E2 548
 - Specifications of E2 Jr. 550
 - Specifications of EC-200 559
 - Specifications of EC-30 557
 - Specifications of EC-50 558
 - Specifications of EX 556
 - Specifications of S3-4K 552
 - Specifications of S3-4K Jr. 554
 - Specifications of standard connections 560
 - Standard connection specifications 560
 - Standard connector pinouts 561
 - Starting up 102
 - Symbols 12
 - System Battery 523
 - System menu 79-80, 84, 86-87, 91
 - Black Invalid 79
 - Diagnostics 87
 - Ethernet 84
 - Lock front panel 91
 - USB Backup/Restore 80
 - VFD brightness 86
 - System modifier area 113
 - System Setup 243
 - System Setup: Backing up the system 252
 - System Setup: Communication setup 248
 - System Setup: Configuration Menu 253-255, 257, 260, 263-264, 266
 - Add Aux Destinations 264
 - Add Background(s) 254
 - Add Inputs 255
 - Add MVR Outputs 266
 - Add Outputs 257
 - Add Screen Destinations & Layers 260
 - Initial Setup 253
 - Layer optimization 263
 - System Setup: Factory default 247
 - System Setup: Multiviewer Menu 278
 - Drop Inputs, Backgrounds and Destinations 278
 - System Setup: Power up and Status check 246
 - System Setup: Programming Menu 268-273, 275-277
 - Capture Stillstore from Inputs & Backgrounds 268
 - Create Sources from Inputs 271
 - Destination Transition 277
 - Drop backgrounds into Screen Destinations 272
 - Drop Inputs to Aux Destinations 275
 - Drop Sources, Layers into Screen Destinations & Sources into layers 273
 - Presets And User Keys 276
 - Select Thumbnails for Backgrounds 269
 - Select Thumbnails for Inputs 270
 - System Setup: Restoring the system 249
 - System Setup: Saving the setup 251
 - System Setup: Setup Prerequisites 244
 - System Setup: setup sequence 245
 - System Setup: User preference 250
- T**
- Terms and definitions 31
 - The 4K screen management system 13
 - Third Party Software Acknowledgements 583-584
 - List and description 584
 - Top Cover 517
 - Tri-Combo Input Card 57
 - Tri-Combo Output Card 65
 - Troubleshooting 579
 - Troubleshooting List 581
- U**
- Unit Configuration 115
 - Configuration Menu (Adjustment area) 115
 - Unlock front panel 91
 - Unpacking 37
 - Updating firmware 279
 - Upgrading firmware using the USB port 280
 - Upgrading firmware using the web Upgrade 282
 - USB device (Backup/Restore) 80
 - User keys configuration 208
 - Programming Menu (Adjustment area) 208
 - Using menu system 74
 - Using the Tech Support menu 92
- V**
- VFD brightness 86
 - VPU Card 69
- W**
- Warranty 585
 - Web App area 230-231, 238, 240-242
 - Setting Menu > Contact us 241
 - Setting Menu > Dashboard 231
 - Setting Menu > Follow us 242
 - Setting Menu > Help 240
 - Setting Menu > Backup & Restore 238
 - Settings Menu 230
 - Web App area (Setting Menu > Tools > Manage Software) 236
 - Web App area (Setting Menu > Tools) 235