

# EIKI

---

## Owner's manual

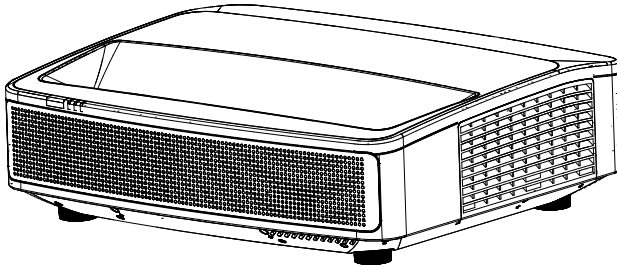

## Multimedia Projector

EK-361WST

EK-362UST

EK-55LU

# Features and Design

This Projector is designed with the most advanced technology for durability and ease of use. This projector utilizes built-in multimedia features, a palette of 1.07 billion colors and matrix liquid crystal display (LCD) technology.

## **Simple Computer System Setting**

---

The projector has the Multi-scan system to conform to almost all computer output signals quickly. Up to 4K resolution can be accepted.

## **Useful Functions for Presentations**

---

- The focus adjustment function allows you to focus on the crucial information during a presentation.
- The built-in speaker (16W) allows you to make a presentation without any external audio equipment.

## **Brightness Control**

---

Laser control selection allow you to setting the suitable brightness for different usage.

## **Logo Function**

---

The Logo function allows you to customize the screen logo.

## **Multilanguage Menu Display**

---

The screen menu of the projector is available in 26 languages: English, German, French, Italian, Spanish, Polish, Swedish, Dutch, Portuguese, Japanese, Simplified Chinese, Traditional Chinese, Korean, Russian, Arabic, Turkish, Finnish, Norwegian, Danish, Indonesian, Hungarian, Czech, Kazakh, Vietnamese, Thai, Farsi.

## **Maintenance-Free**

---

With long life time laser light source and excellent dust resistant system, there is no need to change the Light source at short term.

## **Security Function**

---

The Security function helps you to ensure security of the projector. With the Key lock function, you can lock the operation on the control panel or remote control. PIN code lock function prevents unauthorized use of the projector.

## **LAN Network Function**

---

This projector is loaded with the wired LAN network function. You can operate and manage the projector via network.

## **Auto Setup Function**

---

This function enables input source search and auto PC adjust by simple pressing the AUTO button.

## **Colorboard Function**

---

At the time of simple projection on the colored wall, you can get the close color image to the color image projected on a white screen by selecting the similar color to the wall color from the preset four colors.

## **Power Management**

---

The Power management function would reduces power consumption to save the energy.

✓ Note:

- The screen menu and images in the manual may slightly differ from the real product.
  - The manual is subject to change without prior notice.
-







# Table of contents



Features and Design .....	2	Keylock function.....	39
Table of contents.....	3	Contrast optimization.....	39
Safety operation guideline.....	4	Laser control.....	39
Compliance.....	13	Sound .....	39
Accessories .....	14	HDMI setup.....	39
<b>Overview</b>		<b>OSD Setting-Expand</b>	
<b>Name and function of your projector</b>		Language.....	40
Front/Rear/Bottom .....	16	Auto Setup.....	40
Terminal .....	17	Keystone.....	41
Remote controller .....	18	Logo.....	43
Remote controller operation range .....	19	Security.....	44
Install battery of remote controller .....	19	Power Management.....	45
<b>Installation</b>		Filter counter.....	45
<b>Installation</b>		Test pattern.....	45
Set up your projector .....	21	Network.....	46
Connect the AC power cord.....	22	Factory Default .....	46
<b>Connection to equipment</b>		<b>OSD Setting-Memory Viewer</b>	
Connection to computer.....	23	Memory Viewer.....	47
Connection to video and audio equipment .....	24	<b>OSD Setting-Info.</b>	
<b>Operation</b>		Information.....	48
<b>Basic operation</b>		<b>Description on using useful function</b>	
Power on your projector.....	26	Network control operation.....	50
Power off your projector.....	27	Network display function.....	55
Adjustment Pad .....	28	Memory Viewer function .....	58
Focus adjustment .....	28	USB Display function .....	60
Auto setup function .....	29	<b>Maintenance</b>	
Keystone adjustment .....	29	LED indicator status.....	63
<b>How to use the OSD</b>		Clean casing of your projector.....	64
Menu operation.....	30	Clean the filter.....	64
Menu item overview.....	31	<b>Appendix</b>	
Remote controller operation .....	32	Troubleshooting .....	66
<b>Input selection</b>		LED indicator status.....	68
Input select .....	33	Compatible computer screen.....	70
<b>OSD Setting-Display</b>		Terminal configuration.....	71
Auto PC Adjusting.....	34	Menu Tree.....	72
Manual computer adjustment .....	35	Technical Specifications.....	75
<b>OSD Setting-Color Adjust</b>		Dimensions.....	76
Color Adjust .....	37	PIN code memorandum.....	77
<b>OSD Setting-Setting</b>			
Direct Power On .....	38		
Standby mode.....	38		
High land function .....	38		
Cooling fast setting .....	38		

# Safety operation guideline

## Safety instructions

This document and your projector employ certain symbols to illustrate how to use your projector safely. They are described below: Please get yourself familiar with them before going through this document.

	Caution	Ignoring messages indicated by this symbol may lead to personal injuries or deaths due to human errors.
	Note	Ignoring messages indicated by this symbol may lead to personal injuries or property damage.
		High voltage inside with risks of electric shock.
		Hot surface with risks of person injury.
		Do not look into the lens while the light source is ON. The strong light from the light source may cause damage to your eyesight. Do not stare into the beam which may be harmful to the eyes.
		Do not place anything in front of the lens while the projector is operating. Things placed in front of the lens may overheat and burn or start a fire. If you want to temporarily stop the projected image, use the Blank key on the remote control.

 <div style="border: 1px solid black; padding: 5px; text-align: center;"> <p>Caution</p> <p>Danger of electric shock DO NOT open this.</p> </div> 
<p>Note: DO NOT remove the casing (or back cover) as it may result in electric shock. Users shall not execute any maintenance work on components within your projector except replacing lamps. Call qualified maintenance personnel in case of any maintenance requirements.</p>



High voltage inside with risks of electric shock.



Operation and maintenance tips about these components.

Please read this manual carefully before installing and operating your projector.

Your projector comes with a lot of convenient features and functions. You may make the most of these features and keep your projector in good working conditions by using it correctly. Invalid operation of your projector may not only shorten its life cycle but also may lead to product failure, fire, or other incidents.

In case of any operation abnormality, refer to this manual to check your operation and connections and try solutions given in the “Troubleshooting” section at end of this manual. If the problem persists, call your dealer or our service center.

# Safety operation guideline

## **Warning:**

DONOT leave the projector in the rain or expose it to moisture environment to prevent fire or electric shock.  
The proposed plug should not be used in an extension cord outlet or other outlet unless the pin is fully plugged in.



## **Warning:**

This projector is an RG2 product. The projector is for professional use and must be installed in location where safety is assured. For this reason, be sure to consult your dealer as installation and attachment/detachment of the lens unit must be performed by a professional service personnel. Never try to install the projector by yourself. This may result in visual impairment etc.



## **Caution:**

Avoid displaying stationary images for a prolonged period of time. Doing so can result in these images being temporarily sustained on the surface of the LCD panel.  
If this should happen, continue to use your projector. The static background from previous images will disappear..



## **Caution**

### Safety precautions:

- GROUND your projector.
- Lens of your projector projects strong light. DO NOT look at the light beam directly. You may get your eyesight hurt. This is especially the case with children.
- Unplug the AC power plug if your projector will not be used for long time.
- DO NOT overload the socket of power cord as it may lead to fire or electric shock. DO NOT subject the power cord to any object. DO NOT place your projector in locations where its power cord may become damaged by treading by passersby.
- Disconnect the power plug before cleaning your projector. DO NOT apply liquid or sprays to your projector. DO NOT wipe your projector with wet cloth.
- Please follow warnings and instructions given in labels attached to your projector. Unplug your projector when your projector is exposed to thunderstorm weather, is unmanned, or not in use for long periods to prevent damage caused by lightning and power surges.
- DO NOT use accessories without recommendation by the manufacturer as it may result in potential risks.

# Safety operation guideline

## Disposing of your used product



### **In the European Union**

EU-wide legislation as implemented in each Member State requires that used electrical and electronic products carrying the mark (left) must be disposed of separately from normal household waste. This includes projectors and their electrical accessories. When you dispose of such products, please follow the guidance of your local authority and/or ask the shop where you purchased the product.

After collecting the used products, they are reused and recycled in a proper way. This effort will help us reduce the wastes as well as the negative impact to the human health and the environment at the minimum level.

The mark on the electrical and electronic products only applies to the current European Union Member States.

### **Outside the European Union**

If you wish to dispose of used electrical and electronic products outside the European union, please contact your local authority and ask for the correct method of disposal.



### **For EU:**

The crossed-out wheeled bin implies that used batteries should not be put to the general household waste! There is a separate collection system for used batteries, to allow proper treatment and recycling in accordance with legislation.

**According the EU directive 2006/66/EC, the battery can't be disposed improperly. The battery shall be separated to collect by local service.**

### **Warning:**

This equipment is compliant with Class A of CISPR 32. In a residential environment this equipment may cause radio interference.

# Safety operation guideline



## Caution

### Precautions on air outlet / air intake:

- Keep adequate clearance around your projector for its ventilation and cooling. See figure below for the least clearance requirements. The least clearance is a **MUST** when your projector is placed within a cabinet or other closed environment.

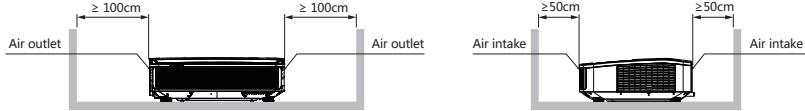

- DO NOT cover the air outlet of your projector. Poor ventilation not only shorten life cycle of your projector but also may lead to risks.
- Slots and openings at rear and bottom of your projector are designed for ventilation. Keep your projector from overheated to ensure its steady operation.
- DO NOT cover the air outlet with cloth or other objects. DO NOT place your projector on the surface of bed, sofa, carpets, or similar object as this may block the air outlets at its bottom.
- DO NOT place your projector in closed environment, e.g. a bookcase, unless it is well ventilated.
- Keep any matter from falling in your projector through the air outlets as they may touch high voltage parts and lead to fire or electric shock by short circuits. DO NOT splash liquid to your projector.



## Note:

### Precautions on location of your projector:

- Place your projector in a proper location or it may result in fire.
- DO NOT expose your projector in rain or high humidity environments or it may result in fire or electric shock. DO NOT place your projector near water or splashing water. DO NOT place any water container, e.g. flower vase, atop your projector.
- DO NOT place your projector in environments of soot, moisture or smoke, e.g. your kitchen, or it may lead to product failure or accidents. Your projector may be damaged by contact with oil or chemicals.
- DO NOT place your projector near exhaust pipe or air conditioning equipment.
- DO NOT place your projector near radiator or heating pipes.
- DO NOT place your projector atop unstable truck, rack, or table. It may fall of the surface and lead to personal injuries and property damages. Please use cart or rack recommended by the manufacturer or included with your product. Please follow steps given in installation guideline included with the wall and ceiling mount racks for installation. Use installation components approved by the manufacturer.
- Be careful when moving your projector with cart. Abrupt stops, pushing too hard and rugged surfaces may topple your projector and the cart together.

# Safety operation guideline



## Note:

### Precautions on using your projector:

- DO NOT project the same image for long time as residual images may be left in the panel. This is a property of LCD panel.
- Use power as indicated in tags attached to your projector. If you have doubts over available power type, consult your dealer or local power company first.
- DO NOT open or remove the casing for maintenance as this may lead to electric shock or other damages. Call qualified maintenance personnel in case of any maintenance requirements.
  - In case of the following, unplug the power cord and call qualified maintenance personnel for service immediately:
    - a. Damaged or broken power cord or plug
    - b. Liquid splashed in your projector
    - c. Your projector exposed to rain or water
    - d. If your projector fails to work as expected by following operation instructions, adjust it according to given instructions. Other invalid operations may damage your projector, which requires the technician to spend more time before returning it back to normal.
    - e. The projector falls off to ground or its casing is damaged.
    - f. In case of any abnormal change in your projector during its use, then maintenance services would be required.
- In case components replacement is required, make sure the replacements have been approved by the manufacturer and features the same with the one being replaced. Use of unauthorized parts may lead to fire, electric shock or personal injury.
- After the completion of maintenance or repair work, get the maintenance personnel to run routine safety check to ensure your projector's safety operation status.

### **Information for users in the European Union**

This is a device to project images onto a screen, etc., and is not intended for use as indoor lighting in a domestic environment.

Directive 2009/125/EC.



# Safety operation guideline

## About High Altitude mode

- Set [HIGH ALTITUDE] to [ON] in the Setting menu when using the projector at altitudes approximately 1700 meters or higher.  
Using the projector at altitudes approximately 1700 meters or higher without setting to [HIGH ALTITUDE] can cause the projector to overheat and the projector could shut down. If this happens, wait a couple minutes and turn on the projector.
- Using the projector at altitudes less than approximately 1700 meters and setting it to [ON] can cause the light module to overcool, causing the image to flicker. Switch [FAN MODE] to [OFF].
- Using the projector at altitudes approximately 1700 meters or higher can shorten the life of optical components such as the light module.

## Light Module

- A light module containing multiple laser diodes is equipped in the product as the light source.
- These laser diodes are sealed in the light module. No maintenance or service is required for the performance of the light module.
- End user is not allowed to replace the light module.
- Contact qualified distributor for light module replacement and further information.

## Laser safety caution



### WARNING

#### CLASS 1 OF IEC 60825-1 THIRD EDITION LASER PRODUCT

- Laser radiation- DO NOT stare into beam.
  - Use of controls or adjustments or performance of procedures other than those specified herein may result in hazardous radiation exposure.
- 
- This product is classified as Class 1 of IEC 60825-1 3rd edition and RG2 of IEC/EN 62471-5 : 2015 First edition. Obey the laws and regulations of your country in relation to the installation and management of the device.
  - Regarding the installation and management of the equipment, please comply with the relevant laws and regulations of your country.
  - Outline of laser emitted from the built-in light module:  
Wavelength: 455 nm  
Maximum laser output: : 333mW
  - Radiation pattern from the protective housing::  
Wavelength: 455 nm  
Maximum laser output: : 333mW
  - The laser module is equipped in this product. Use of controls or adjustments of procedures other than those specified herein may result in hazardous radiation exposure.

# Safety operation guideline

## Laser radiation range

The figure below shows the maximum range of laser radiation.(°)

### Horizontal Angle (Unit: degree)

Model	H
XGA	63
WXGA	64.8
WUXGA	64.8

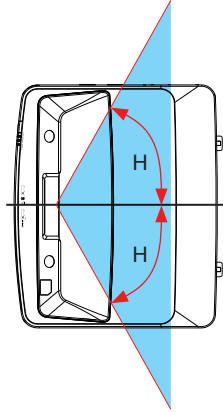

### Vertical Angle (Unit: degree)

Model	V1	V2
XGA	10.9	37.7
WXGA	11.4	36.8
WUXGA	11.4	36.8

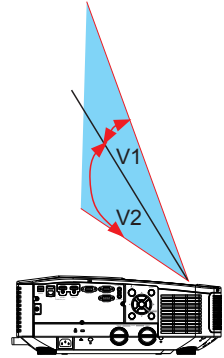

## Safety Labels

The caution and the explanatory labels of the LASER PRODUCT in CLASS 1 conforming to IEC 60825-1 Second edition, and in Class 1 conforming to IEC 60825-1 Third edition are stuck on the below indicated positions.

### Label 1



### Label 2



### Label 1

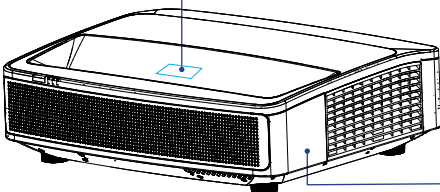

### Label 2

# Safety operation guideline

## Air ventilation

Openings in the casing are designed for ventilation and overheating prevention. DO NOT block or cover these openings to keep your projector in normal operation and from overheating.

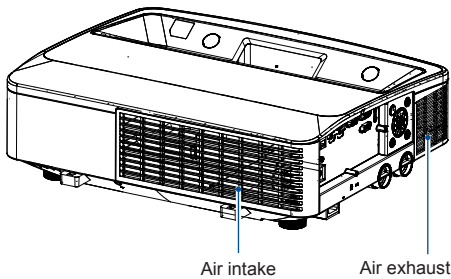
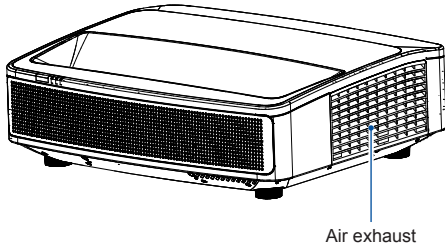

### Note:

Heat exhaust at the air outlet. Keep the following in mind when using or installing your projector:

- DO NOT place flammable materials or sprayers near your projector.
- Keep the air outlet one meter away from other objects.
- DO NOT touch the area close to the air outlet especially the metal components, e.g. screws. This area and parts will get very hot once your projector starts operating.
- DO NOT place any object atop your projector. They may not only be damaged but also lead to fire after being overheated.

Cooling fans are designed for cooling your projector. Fan speed is auto adjusted subject to internal temperature of your projector.

## Place your projector correctly

Use your projector at specified location in correct way. Invalid projector location may shorten light source's life-cycle or even lead to severe incidents or fire.

### 360° projection

Our projector support 360° projection.

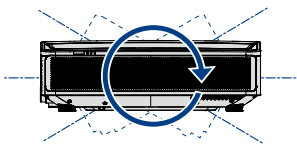

Vertical 360°

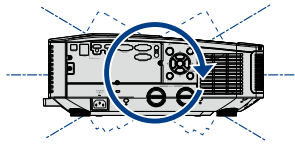

Horizontal 360°

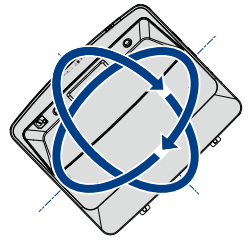

Vertical & Horizontal 360°

# Safety operation guideline



Note:

## Precautions on ceiling mount bracket installation:

- Get qualified technician to install the ceiling mount bracket.
- Warranty of your projector does not cover hazards and damage caused by using ceiling mount brackets provided by unauthorized dealers.
- Remove the ceiling mount bracket when it is not in use.
- Apply torque driver instead of power driver or impact driver in your projector.

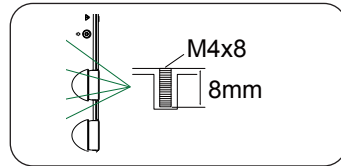
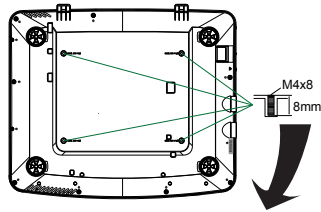

## Moving your projector

When moving your projector close its adjustment legs as they may damage the lens and casing. Keep your projector in suitable box when it is not to be used for a long time.



Note:

## Precautions on moving or shipping your projector:

- DO NOT drop or impact your projector as it may get damaged or failed in operation.
- Please employ proper container for movement.
- Prohibit express or other shipping service provider personnel from shipping your projector with improper boxes. Your projector may become damaged. Please consult your dealers for shipping your projector by express or other shipping service providers.
- Place your projector in box only after it has been fully cooled down.

# Compliance

## FCC Caution

### Declaration of Conformity

This device complies with Part 15 of the FCC Rules.

Operation is subject to the following two conditions:

(1) This device may not cause harmful interference, and (2) this device must accept any interference received, including interference that may cause undesired operation.

To assure continued compliance, follow the attached installation instructions and do not make any unauthorized modifications.

### CAUTION:

This equipment has been tested and found to comply with the limits for a Class A digital device, pursuant to part 15 of the FCC Rules. These limits are designed to provide reasonable protection against harmful interference when the equipment is operated in a commercial environment. This equipment generates, uses, and can radiate radio frequency energy and, if not installed and used in accordance with the instruction manual, may cause harmful interference to radio communications. Operation of this equipment in a residential area is likely to cause harmful interference in which case the user will be required to correct the interference at his own expense.

Model Number : EK-361WST series

Trade Name : EIKI

Responsible party : EIKI International, Inc.

Address : 22552 Avenida Empresa Rancho Santa Margarita, CA 92688 U.S.A.

Telephone No. : 800-242-3454 (949-742-6800)

## AC Power Cord Requirement

The AC Power Cord supplied with this projector meets the requirement for use in the country you purchased it.

### AC Power Cord for the United States and Canada:

AC Power Cord used in the United States and Canada is listed by the Underwriters Laboratories (UL) and certified by the Canadian Standard Association (CSA).

AC Power Cord has a grounding-type AC line plug. This is a safety feature to be sure that the plug will fit into the power outlet. Do not try to defeat this safety feature. Should you be unable to insert the plug into the outlet, contact your electrician.

### AC Power Cord for the United Kingdom:

This cord is already fitted with a moulded plug incorporating a fuse, the value of which is indicated on the pin face of the plug. Should the fuse need to be replaced, an ASTA approved BS 1362 fuse must be used of the same rating, marked thus . If the fuse cover is detachable, never use the plug with the cover omitted. If a replacement fuse cover is required, ensure it is of the same colour as that visible on the pin face of the plug (i.e. red or orange). Fuse covers are available from the Parts Department indicated in your User Instructions.

If the plug supplied is not suitable for your socket outlet, it should be cut off and destroyed.

The end of the flexible cord should be suitably prepared and the correct plug fitted.

### **WARNING : A PLUG WITH BARED FLEXIBLE CORD IS HAZARDOUS IF ENGAGED IN A LIVE SOCKET OUTLET.**

The Wires in this mains lead are coloured in accordance with the following code:

Green-and-yellow . . . . .	Earth
Blue . . . . .	Neutral
Brown . . . . .	Live

As the colours of the wires in the mains lead of this apparatus may not correspond with the coloured markings identifying the terminals in your plug proceed as follows:

The wire which is coloured green-and-yellow must be connected to the terminal in the plug which is marked by the letter E or by the safety earth symbol  or coloured green or green-and-yellow.

The wire which is coloured blue must be connected to the terminal which is marked with the letter N or coloured black.

The wire which is coloured brown must be connected to the terminal which is marked with the letter L or coloured red.

### **WARNING: THIS APPARATUS MUST BE EARTHED.**

**THE SOCKET-OUTLET SHOULD BE INSTALLED NEAR THE EQUIPMENT AND EASILY ACCESSIBLE.**

# Accessories

Quick Start Guide

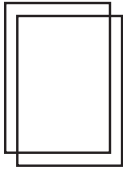

AC Power Cord

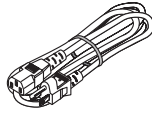

Remote Control



Safety Information

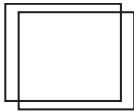

VGA Cable

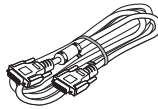

# Overview

This chapter presents names and functions of individual component.

# Name and function of your projector

## Front/Side

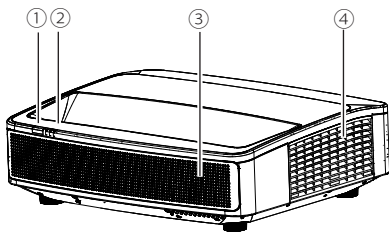

- ① Remote control receiver
- ② LED indicator - Power / Status / Light
- ③ Speaker
- ④ Exhaust vent

 **Caution:**

Air exhaust emits hot air. DO NOT place heat sensitive objects near it.

## Rear/Side

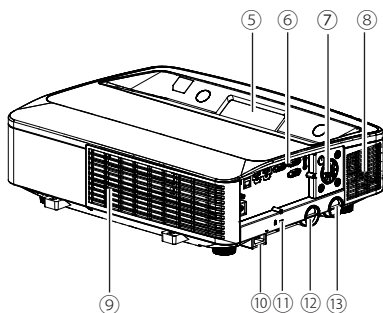

- ⑤ Projection window
- ⑥ Terminals
- ⑦ Control panel
- ⑧ Exhaust vent
- ⑨ Inlet vent
- ⑩ AC cord connector
- ⑪ Kensington Security Slot
- ⑫ Focus adjustment ring - center
- ⑬ Focus adjustment ring - corner

 **Note:**

- Kensington Security Slot is for a Kensington lock used to deter theft of the projector.
- Kensington is a registered trademark of ACCO Brands Corporation.

## Bottom

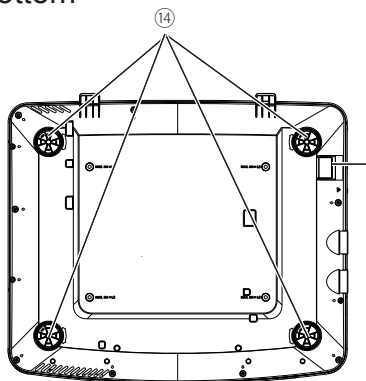

- ⑭ Adjustable foot



# Name and function of your projector

## Terminal

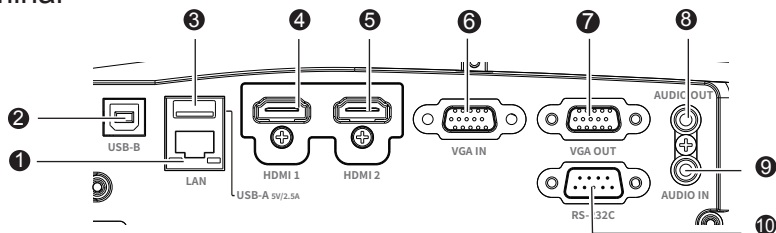

- 1 LAN**  
Connect network cable to this port for controlling and operating your projector via network.
- 2 USB-B IN**  
The terminal is to use the USB display function, when connected the projector to computer with USB cable
- 3 USB-A IN**  
When using the Memory Viewer function, insert the USB memory directly to this terminal.
- 4 HDMI 1 IN**  
Connect HDMI digital output signals to this terminal.
- 5 HDMI 2 IN**  
Connect HDMI digital output signals to this terminal.
- 6 VGA IN**  
Connect output signal from computer to this terminal.
- 7 VGA OUT**  
Transmit signals from **6** to other displays
- 8 AUDIO OUT**  
Output audio signals to amplifier or other audio equipment.
- 9 AUDIO IN**  
"Line out" to "AUDIO OUT" terminal from input audio signals. (Speakers are not equipped.)
- 10 RS232C**  
Connect serial cable to this terminal when using RS232 device to control or operate your projector.
- 11 Kensington Security Slot**  
This slot is for a Kensington lock used to deter theft of the projector.  
\* Kensington is a registered trademark of ACCO Brands Corporation
- 12 Power cord connector**

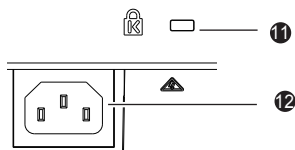

# Name and function of your projector

## Remote controller

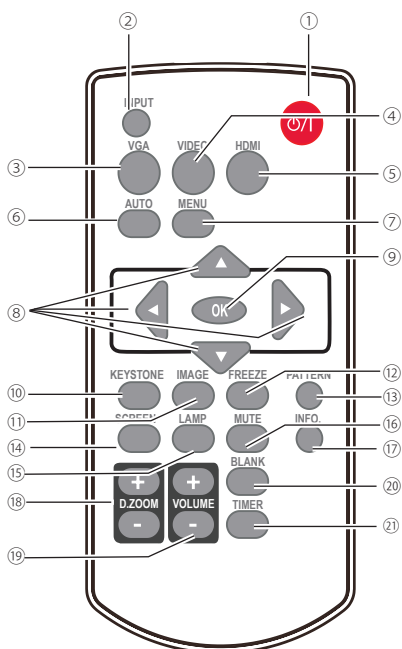

- ① **POWER**  
Turn the projector power on or off.
- ② **INPUT**  
Display the input source menu on screen.
- ③ **VGA**  
Select "VGA" as input source.
- ④ **VIDEO**  
Select "Video" as input source.
- ⑤ **HDMI**  
Select "HDMI 1 / HDMI 2" as input source.
- ⑥ **AUTO**  
Launch the auto setup function.
- ⑦ **MENU**  
Display the main menu on screen.

- ⑧ **▲▼◀▶ button**
  - Select item or adjust data at OSD menu.
  - Select the image display area in digital zoom + mode.
- ⑨ **OK**  
Enter the sub-menu or select an item.
- ⑩ **KEYSTONE**  
Display the keystone adjustment menu on screen.
- ⑪ **IMAGE**  
Switch the image mode.
- ⑫ **FREEZE**  
Freeze the projected image.
- ⑬ **PATTERN**  
Display the internal test image.
- ⑭ **SCREEN**  
Switch the aspect ratio of projection image.
- ⑮ **LAMP**  
Setting the light source mode.
- ⑯ **MUTE**  
Mute the sound.
- ⑰ **INFO.**  
Display the projector information.
- ⑱ **D.ZOOM +/-**  
Digital zoom in / zoom out the image.
- ⑲ **VOLUME +/-**  
Increase / decrease the volume.
- ⑳ **BLANK**  
Temporarily close the image on the screen.
- ㉑ **TIMER**  
Enable the timer function.

# Name and function of your projector

## Remote controller operation range

Point your remote controller to the IR receiver of your projector

Maximum operation range of your remote controller is an angle within 30° perpendicular.

The Maximum operation distance in front of the IR receiver is 7 meters.

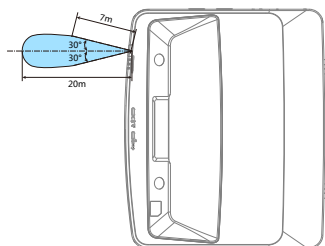

## Install battery of remote controller

① Open the battery cover.

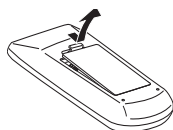

② Inserting the new batteries.

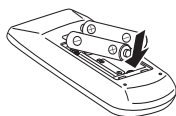

Two AAA batteries with correct polarity (+ and -), be sure battery terminals are in contact with pins in the compartment.

③ Put the cover back.

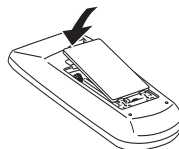

Please follow the following rules for safety operation:



- Use two of AAA or LR3 alkaline batteries.
- Always replace batteries in sets
- Do not mix new and old batteries as one pair.
- Keep your remote controller away from water or other liquids.
- Do not expose your remote controller to environments with high humidity or temperature.
- Do not drop your remote controller.
- In case of any battery solution leaking in the compartment, clear it thoroughly before placing new batteries in it.
- Using battery of other types than what specified on this manual may lead to risks of explosion.
- Please dispose your old battery by following instructions given in tag of the battery or local regulations.

# Installation

This chapter introduces the information of install.

# Installation

## Set up your projector

- Ambient brightness may affect your projection image quality. For the optimal image effect, it is recommended to control brightness in your environment.
- Values shown in figure below are approximates only. They may differ from the actual ones.

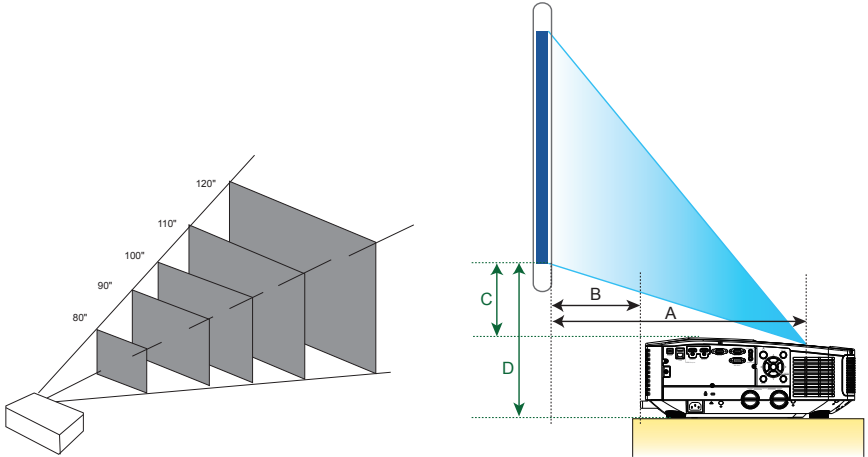

16:10

Unit:mm

Screen size	85"		90"		100"		110"		120"	
	Height	Width	Height	Width	Height	Width	Height	Width	Height	Width
		1144	1831	1212	1939	1346	2154	1481	2369	1615
A	433		456		501		546		592	
B	5		28		73		118		164	
C	147		159		182		206		230	
D	313		325		348		372		396	

16:9

Unit:mm

Screen size	85"		90"		100"		110"		120"	
	Height	Width	Height	Width	Height	Width	Height	Width	Height	Width
		1058	1882	1121	1992	1245	2214	1370	2435	1494
A	445		468		515		561		608	
B	17		40		87		133		180	
C	211		226		257		289		320	
D	377		392		423		455		486	

# Installation

## Connect the AC power cord

Standard voltage employed by your projector is AC 100-240V. It adapts to different input voltage automatically. Your projector employs 2-phase power cord with neutral ground cable.

Do not use any other type of power cords or you may face the risks of electric shock. In case you have any doubt on type of power cord you are using, please call authorized dealer or service center for help. Before powering on your projector, get all external equipment connected in advance.



Note:

Keep your AC power socket close to your projector for easy plugging and unplugging.

✓ Note:

For safety reasons, unplug the AC power cord when your projector is not in use. Your projector will consume a small amount of power when it is connected to AC grid power and in standby mode.

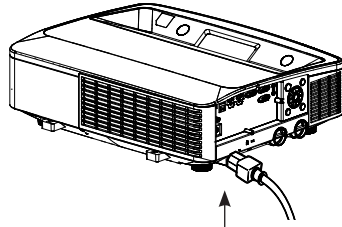



Connect included AC power cord to your projector.

### Precautions on power cord

Your AC power cord should meet regulations of the country/district where your projector is used.

Please make sure the type of the power plug is compliant with those given in figure below. Make sure you are using a valid AC power cord.

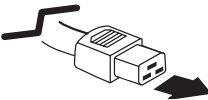
In case the included AC power cord does not comply with the AC power socket in your location, call your dealer for replacement.

The projector side	Connect to the AC power socket
 <p data-bbox="127 1086 468 1129">Connect to power cord connector of your projector</p>	<p data-bbox="736 962 880 986">Grounding end</p>  <p data-bbox="624 1090 893 1114">Connect to AC power socket</p>

✓ Note:

- Use of invalid power cord may hamper product performance or even lead to electric shock, fire, and other incidents. Please use power cord compliant with the included one to ensure product performance and operation safety.
- The frequently used cables are: AC power cord, VGA cable, audio cable, video cable, and RS232 control cable.

# Connection to equipment

## Connection to computer

Cables used for connection:

- VGA cable
- USB cable\*
- RJ45 cable\*
- HDMI cable\*
- USB device\*
- Serial cable\*

(\*Cables are not supplied with the projector)

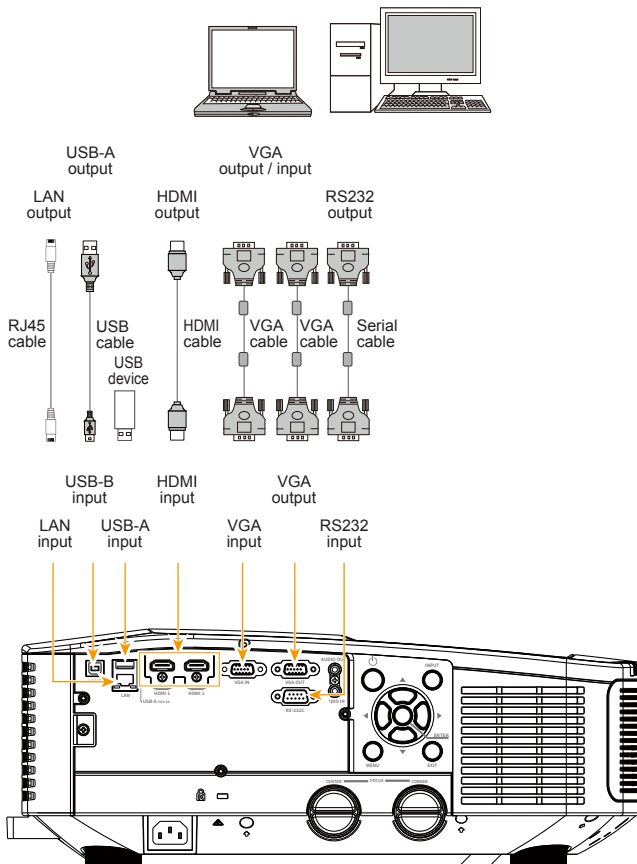

Unplug power cords of the projector and all external equipment before connecting any cable to them.

# Connection to equipment

## Connection to video and audio equipment

Cables used for connection:

- Audio cable\*
- HDMI cable\*

(\*Cables are not supplied with the projector)

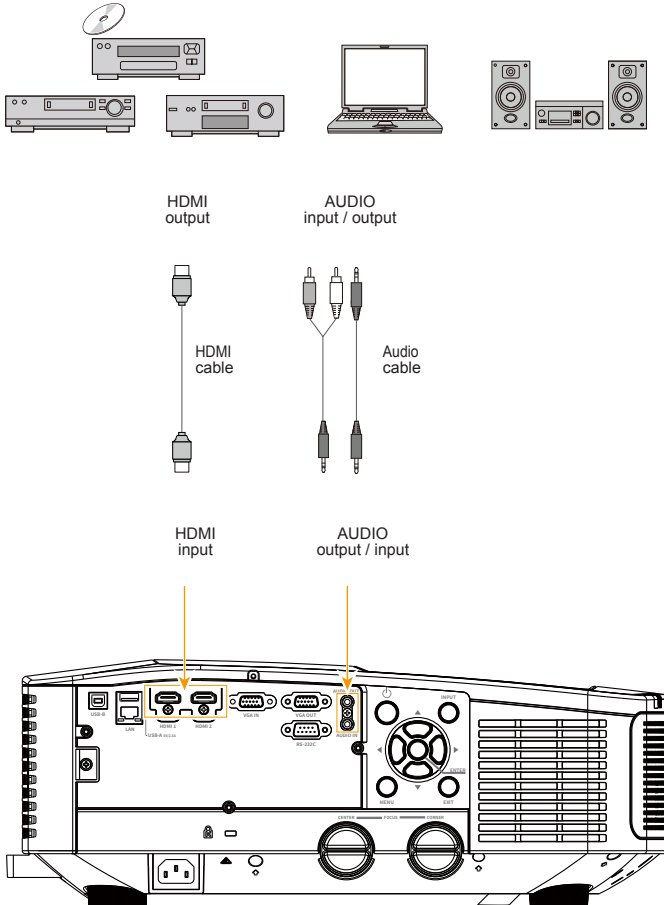

Unplug power cords of the projector and all external equipment before connecting any cable to them.



# Operation

This chapter introduces you to basic operation of your projector.

# Basic operation

## Power on your projector

1. Connect all external equipment to your projector (e.g. computer or media player) before powering it on.
2. Connect AC power cord of your projector to an AC power socket. The Power indicator turns on in red.
3. Press the Power button on the control panel or the remote controller.  
The Power indicator lights in green and the cooling fan starts running.
4. If your projector is setting as password protected, the password dialog box displays. Enter your password as instructed below.

✓ Note:

- In case the "Logo Select" option is set to OFF, then no welcome image will display in screen.

### Enter password (PIN)

Press OK button to insert the PIN code. Press ◀▶ button to select number, then press OK button to set it and the cursor would move to next field automatically. The number you set is displayed as "\*" . Repeat to fill in a 3-digit number. If any mistake, press MENU button to reset.

After fill in the PIN code, the cursor would move to the "Set" selection. Press the OK button and now you are ready to use your projector. Or press ▶ button select "Cancel" to give up the setting.

If the password is invalid, the password displayed as "\*\*\*" in red and reset within one second automatically. Please try again with a valid one.

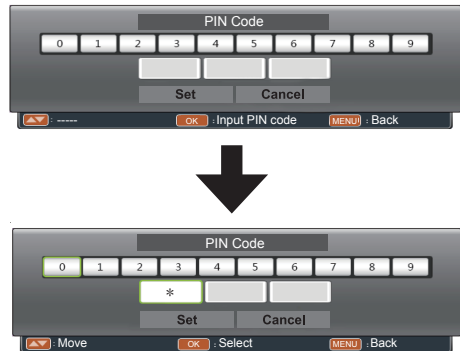

### What is a password (PIN)?

A password (PIN) is an ID code for identifying people who know about it to operate your projector. A password (PIN) setting may help preventing your projector from unauthorized use.

Your password (PIN) code is a 3-digit number. To find out more about protecting your projector with a password (PIN), please refer to the PIN Code Lock function in the SecurIt menu on Page 44 for details.

### Precautions on password (PIN) operation

You cannot operate a password (PIN) protected projector without correct password (PIN)

Please set up a new password (PIN) and keep your operation manual in safe place. In case the password (PIN) is lost or forgotten, contact your dealer or service center.

# Basic operation

## Power off your projector

1. Press the Power button at the control panel or the remote controller, then “Power off?” message displays.
2. Press the Power button again within 4 seconds after the “Power off?” message prompted to you. The POWER indicator flashes red while the cooling fan continues running. Unplug the power cord after the fan stops running. Failure to do so may shorten life cycle of your projector or lead to power on failures or operation abnormalities.
3. The POWER indicator stops flashing once the projector has been cooled down to ready for power on again.



“Power off ? ” disappears after 4 seconds.



To maintain the life cycle of the laser light source, power off your projector after it has been turned on for at least five minutes.

Do not use your projector without stop. As it may hurt the life cycle of your lamp. Power off your projector at least once every 24 hours and have it idle for an hour.

### ✓ Note:

- Speed of the cooling fan varies with internal temperature of your projector.
- Do not place your projector in any box before it is fully cooled down.
- In case the POWER indicator flashes or turns red, refer to the “LED indicator status” for instructions. (Refer to page 68)
- The POWER indicator flashes when the laser light source is cooling down. Do not power on your projector at this time. Power on your projector only after the POWER indicator turns steady red.
- Unplug the power cord after your projector has been turned off and the fan for cooling stops running.
- The POWER indicator turns red when your projector is ready for power on again. It takes less time to restart your projector after it was powered off with the standard power off procedure than the one with non-standard procedure.

# Basic operation

## Adjustment pad

- You may use the adjustment leg to raise your projector up to 18 mm / +2°.
- Turn the pad to tilt your projector to required height.
  - To raise your projector, turn both pads clockwise.
  - To lower down your projector or close the pad, turn both pads counterclockwise.
- You can launch the auto setup function to adjust the keystone distortion automatically or do it with the remote controller or OSD menu manually.

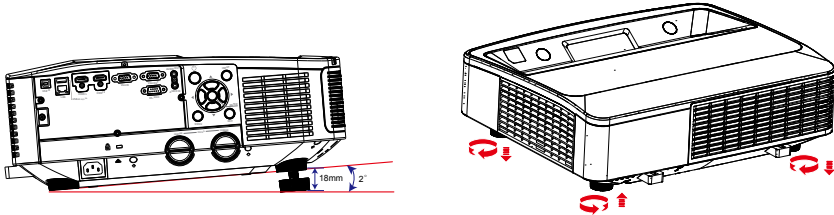

## Focus Adjustment

- 1) Select the test chart function.
  - Press the PATTERN button on the remote control to launch the "Grid" test pattern.
  - Press the MENU button on the remote control to display the on-screen menu, select the "Expand" menu, press the OK button or ► button to confirm the selection of the "Test pattern" option, then press the OK button or ► button to confirm and enter the "Grid" option, and press the OK button to confirm.
- 2) Turn the button A clockwise or counterclockwise to adjust the focal length at the center position;

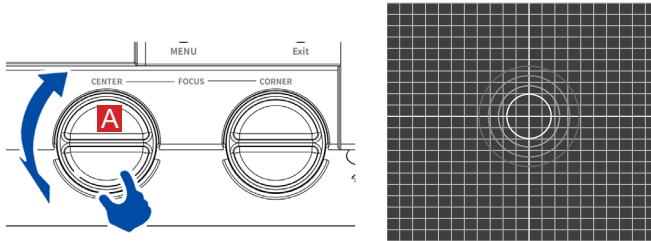

- 3) Turn the B button clockwise or counterclockwise to adjust the focal length of the four corners of the screen;

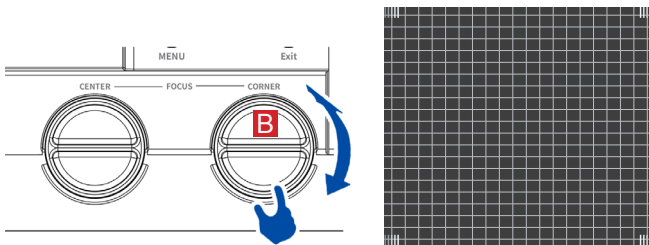

# Basic operation

## Auto setup function

Press the AUTO button on your remote controller to auto execute settings given in the Auto Setup menu (including Auto Input Searching, and Auto PC Adjusting).

## Keystone adjustment

You may adjust keystone distortion of image with the keystone adjustment.

Follow steps below to adjust keystone distortion of projected image manually.

Press the KEYSTONE button on your remote controller.

The Keystone selection menu show up, press ▲▼ button to select the adjustment.

The keystone adjustment dialog box displays, press ▲▼◀▶ button to adjust keystone distortion.

You may save your settings for keystone adjustment.

### Auto Setup

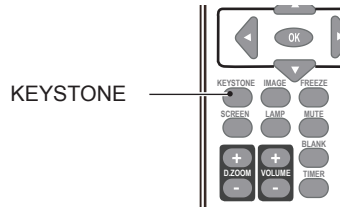
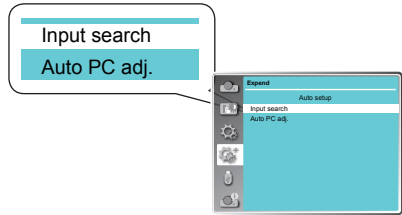

### Keystone adjustment

#### H/V Keystone

4-Corner correction

6-Corner correction

Curved correction

Grid adjustment

Reset value

#### H/V Keystone

Adjust the projected image when the projector is on the horizontal or vertical keystone distortion.

#### 4-Corner correction

Adjust the projected image when the projector is keystone distortion of four corners.

#### 6-Corner correction

Adjust the projected image when the projector is keystone distortion of six corners

#### Curved correction

Adjust the projected image when the projector linearity is uneven or the projected images bent vertically and horizontally.

#### Grid adjustment

Adjust the projected image by the grid of the image.

#### Reset value

The correction values will be restored to the factory defaults.

#### ✓ Note:

- The adjustable range is subject to input signal.
- For details please refer to page 41)

# Basic operation

## How to use the OSD

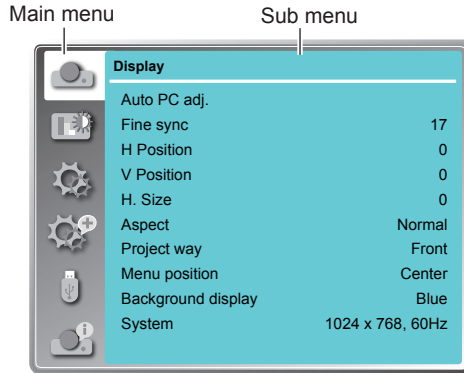

## Menu operation

1. Press the MENU button on the control panel or the remote controller and then OSD displays.
2. Press ▲▼ button to act on or select one main menu item. Press ► button or OK button to enter a submenu.
3. Press ▲▼ button to select required submenu, then press OK button or ► button to set up or enter an option.
4. Press ▲▼◀▶ button to select settings or navigate options, then press OK button to act on the item and exit.
5. Press ◀ button to return to mainmenu. Press the MENU button on remote controller or control panel to exit the OSD.

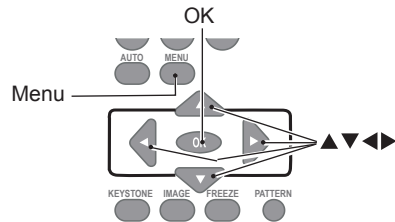
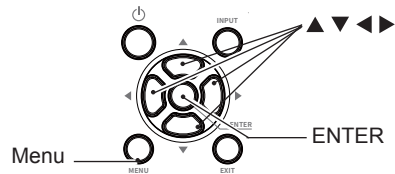

# Basic operation

## Menu item overview

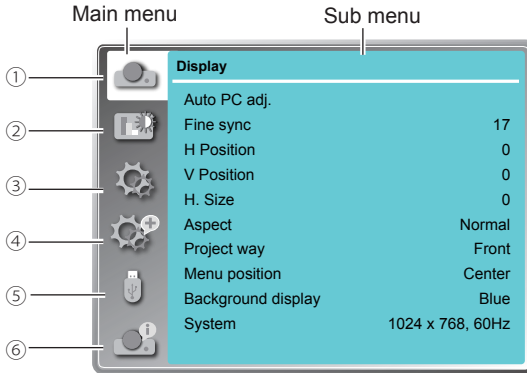

### ① Display

Select Auto PC Adj., Fine sync., H Position, V Position, H size, Aspect, Project way, Menu position, Background display, System to align each parameter with VGA input signal format.

### ② Color adjust

For computer input source, the color adjust options are:

Image mode (Cinema/ Blackboard(Green)/ DICOM/ Colorboard/ User Image/ Dynamic/ Standard), Contrast, Brightness, Color temp., Red, Green, Blue and sharpness.

For the input source as video equipment, the color adjust options are:

Image mode (Cinema/ Blackboard(Green)/ DICOM/ Colorboard/ User Image/ Dynamic/ Standard), Contrast, Brightness, Color, Tint, Red, Green, Blue and sharpness.

### ③ Setting

Used to set the projector's operating configurations.

### ④ Expand

Setting the Language, Auto setup (Input search/ Auto PC adj.), Keystone, Logo, Security, Power management, Filter counter, Test pattern, Network and Factory default function as you need.

### ⑤ Memory Viewer

Setting the display method of Memory Viewer page as Set slide, Slide transition effect, Sort order, Best fit, Rotate, Repeat and Apply.

### ⑥ Info.

Display the input source information and the condition of projector.

# Basic operation

## Remote controller operation

Use your remote controller for common operations.

### Auto setup function (AUTO)

Press the AUTO button to auto execute the settings set in the Auto Setup menu (including Auto Searching and Auto PC Adjusting)

### Image mode selection (IMAGE)

Press the IMAGE button to select required image mode.

### Screen size selection (SCREEN)

Press the SCREEN button to select required screen size.

### Digital Zoom (D.ZOOM+/-)

Press the D.ZOOM+/- button to enter the Digital Zoom mode.

\*Only for input as VGA and the screen size setting as Normal or Wide.

### Freeze (FREEZE)

Press the FREEZE button to freeze image on the screen. Press the FREEZE button or any button to disable the freeze function.

### Blank (BLANK)

Press the BLANK button, a blank screen displays to replace existing image. Press the BLANK button or any other button to restore the image.

Press the BLANK to toggle switch your screen as shown below:

BLANK → Normal → BLANK → Normal → .....

### Timer (TIMER)

Press the TIMER button, a timer animation (00:00) displays and starts timing in format of (00:00-59:59).

Press the TIMER button again to stop timing.

Press the TIMER button again to disable the timing function.

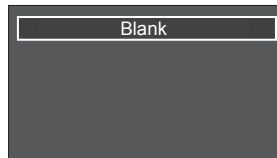
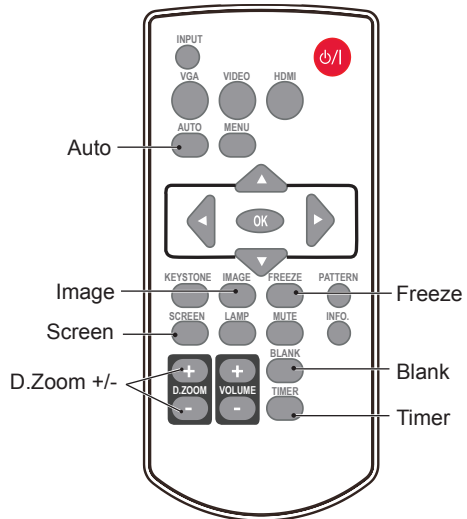

The "Blank" notification will disappear in 4 seconds.



Timer display



# Input selection

## Input select

### Direct Operation

Press VGA, HDMI on the remote control as input source.

### Menu operation

- 1 Press INPUT button on the remote control or control panel to display the input select menu.
- 2 Press ▲▼ button to select VGA, HDMI 1, HDMI 2, Memory Viewer, Network or USB Display, then press the OK button.

#### VGA

When input source is from computer connected to VGA terminal with VGA cable, please select "VGA".

#### HDMI 1

When input source is from equipment connected to HDMI terminal with HDMI cable, please select "HDMI 1".

#### HDMI 2

When input source is from equipment connected to HDMI terminal with HDMI cable, please select "HDMI 2".

#### Memory Viewer

When input source is from device connected to USB-A terminal, please select "Memory Viewer".

#### Network

When input source is from network connected to LAN terminal with LAN cable, please select "Network".

#### USB Display

When input source is from the device connected to USB terminal, please select "USB Display".

#### ✓ Note:

- When the "Input search" function is set to "On" in the "Auto setup" function, the input signal will be searched automatically.
- When input signal is from "USB Display", "Memory Viewer" and "Network", the FREEZE, ASPECT, IMAGE, AUTO SETUP, TEST PATTERN and SCREEN function cannot work.

## Remote control

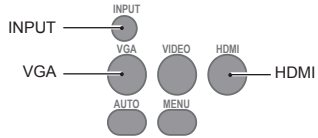

## Control Panel

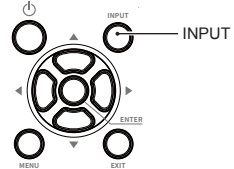

## Input select menu

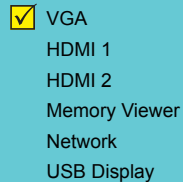

# OSD Setting-Display

## Auto PC Adjusting

The Auto PC Adjusting function may get Total Dots, Horizontal and Vertical position, Display area H, and Display area V aligned with computer input.

### Direct Operation

Press Auto button on the remote control to launch the Auto PC Adj. function.

### Menu Operation

- 1 Press the MENU button on the control panel or on the remote controller and the OSD displays. Press ▲▼ button to select Display icon. Press ► button or OK button and get into Display selection menu.
- 2 Press ▲▼ button to point to Auto PC Adj. option, press OK button to launch it.

#### ✓ Note:

- The projector executes the Auto PC adjustment automatically when the computer signals input the projector for the first time.
- Auto PC adjustment may not work depending on the model of the computer and the input signal.
- The Auto PC adjustment cannot be operated when 480i, 576i, 480p, 576p, 720p 1080i or 1080p is selected in the "Display" menu → "System", or when the signal is coming from the HDMI terminal.

Remote control

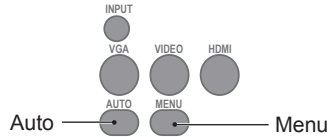

Control Panel

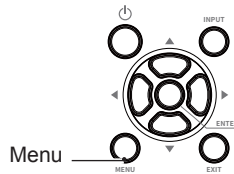

Display menu

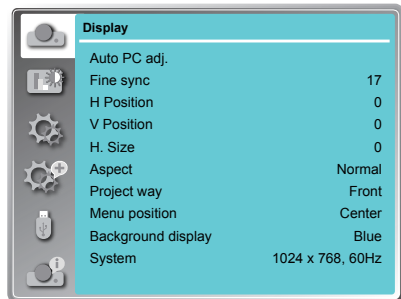

# OSD Setting-Display

## Manual PC signal format adjustment

The scan system of your projector may fail to detect signal format used by certain computers as they opted some special signal format. The manual computer adjustment function of your projector enables you to adjust individual parameter to align with most special signal format.

- 1 Press MENU button on the remote controller or control panel and the OSD displays. Press ▲▼ button to select Display icon, press ► button or OK button to confirm your selection.
- 2 Press ▲▼ button to select items for adjustment, press ► button or OK button to confirm your selection or press ▲▼ button to adjust settings.

### Auto PC adj.

Adjust [Fine sync], [H Position], [V Position] and [H Size] automatically.

### Fine Sync

Eliminate flashes in image. Press ▲▼ button to adjust Total Dots. (From 0 to 31)

### H Position

Press ▲▼ button to adjust horizontal position of image.

### V Position

Press ▲▼ button to adjust vertical position of image.

### H size

Adjust and minimize the effect of interference caused by projection of patterns consisting of vertical stripes.

The projection of the vertical striped pattern may cause cyclic patterns (noise). Adjust to minimize the amount of interference. (From -15 to +15).

Note: H.Size must be set before adjust Fine sync.

### Aspect

Press ▲▼ button to choose the selection to set the screen size to fit the image while maintaining the aspect ratio of the input signal.

Normal.....Projects the image at the maximum size while maintaining the aspect ratio of the input signal.

16:9.....Projects the image at 16:9 aspect ratio.

16:10.....To provide an image to fit the screen.  
(\*Only for VGA and HDMI input signal)

Auto PC adj. Menu

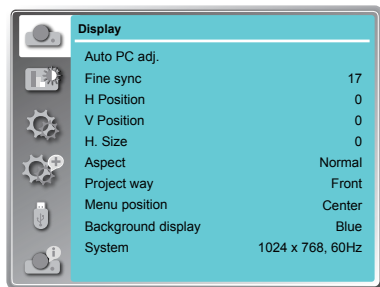

### ✓ Note:

- The projector executes the Auto PC adjustment automatically when the computer signals input the projector for the first time.
- Auto PC adjustment may not work depending on the model of the computer and the input signal.
- The Auto PC adjustment cannot be operated when 480i, 576i, 480p, 576p, 720p 1080i or 1080p is selected in the "Display" menu → "System", or when the signal is coming from the HDMI terminal.

Aspect menu

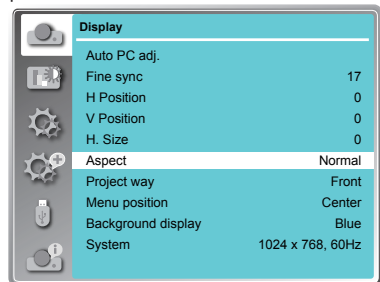

### ✓ Note:

- The adjustment of Fine sync, H Position, V Position and H.Size is only for computer signal input.
- The Fine Sync, Total Dots and Clamp function will be disabled if 480i, 576i, 480p, 576p, 720p, 1080i or 1080p has been selected in the system menu.

# OSD setting-Display

## Project way

Press ▲▼ button to select the project way.

Front .....Projects to front screen when projector is front standing.

Rear.....Projects to rear screen when projector is front standing.

Ceiling/Front ..... Projects to front screen when projector is in ceiling state.

Ceiling/Rear ..... Projects to rear screen when projector is in ceiling state.

Auto Ceiling/Front: Projects to front screen when projector is in ceiling state automatically.

Auto Ceiling/Rear: Projects to rear screen when projector is in ceiling state automatically.

## Menu position

Press▲▼ button to select the position of the on screen menu.

Upper left.....Menu locates on upper left of the screen.

Upper right.....Menu locates on upper right of the screen.

Center .....Menu locates at the center of the screen.

Lower left.....Menu locates on lower left of the screen.

Lower right.....Menu locates on lower right of the screen.

## Background display

Press ▲▼ button to select the screen background of the projector when there is no signal detected.

Black .... Select black background.

Blue ..... Select blue background.

## System

The projector automatically tunes to various types of computers with its function of Multi-scan system and Auto PC Adjustment. If a computer is selected as a signal source, the projector automatically detects the signal format and tunes to project proper images without any additional setting.

One of the following messages may appear when input source as computer:

**Auto** When the projector cannot recognize the connected signal conforming to the provided computer system, Auto is displayed on the System menu box and the Auto PC Adj. function works to display proper images. If the image is not projected properly, a manual adjustment is required.

**-----** There is no signal input from computer. Check the connection between your computer and projector.

## Project way menu

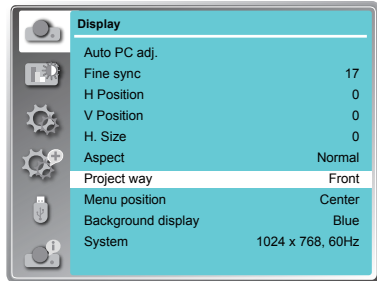

## Menu position

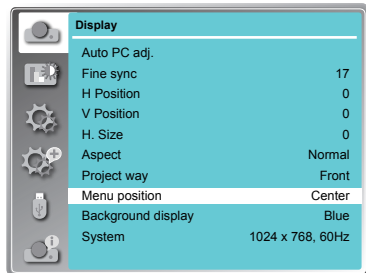

## Background display

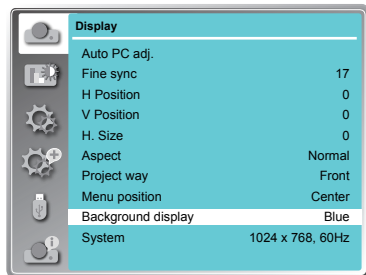

# OSD setting-Color Adjust

## Color Adjust

### Menu operation

- 1 Press the MENU button on remote controller and the OSD displays. Press ▲▼ button select Color Adjust icon, press ► button or OK button to confirm your selection.
- 2 Press ▲▼ button to point to required item and press OK button to confirm your selection.

### Image mode

Switch image mode to fit the image source and the projector. (default setting is Standard)

#### Dynamic

The light output is maximized for use in bright room.

#### Standard

Normal picture level preset on the projector.

#### Cinema

Enriched grayscale for viewing movies.

#### Blackboard (Green)

An image mode designed for displaying on a blackboard (Green). It boosts quality of image projected on blackboard (Green). This is designed for a board in green rather than black as indicated by its name.

#### DICOM

A highly clear X-ray image is reproduced. Digital radiographs with excellent detail and clarity for medical training, presentations and conferences.

#### Colorboard

Image mode suitable for image projecting on surface of wall in red, blue, yellow or green.

#### User Image

Default image mode set by users in the Image Adjust menu.

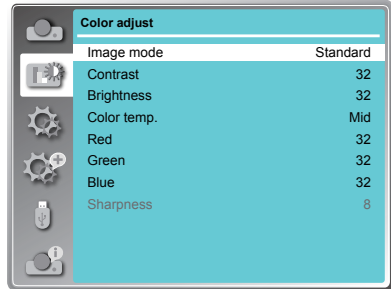

### Contrast

Press ▼ button to decrease contrast, press ▲ button to increase contrast.

### Brightness

Press ▼ button to decrease brightness, press ▲ button to increase brightness

### Color Temp.

Press ▲▼ button to select required color temperature

High: Blueish image color

Mid.: Natural image color

Low: Reddish image color

### Red

Press ▼ button to lighten red tint and ▲ button to darken it.

### Green

Press ▼ button to lighten green tint and ▲ button to darken it.

### Blue

Press ▼ button to lighten blue tint and ▲ button to darken it.

### Sharpness

Press ▼ button to soften image and ▲ button to sharpen it.

# OSD setting-Setting

## Setting

Your projector comes with convenient adjustment function.

- 1 Press the MENU button on remote controller and the OSD displays. Press ▲▼ button to select Setting icon, press ► button or OK button to confirm your selection.
- 2 Press ▲▼ button to point to required item and press OK button to confirm your selection.

### Direct power on

Setting the projector to be turned on automatically just by connecting the AC power cord.

On ... Start the projection immediately.

Off ....Start up in the standby mode.

### Standby mode

Setting the power consumption in standby mode.

Eco.....Restrict control functions in the standby mode to reduce power consumption. In this case, you could control the projector with limited.

Network..Restrict network and serial communication function to reduce power consumption.

Normal ...Do not restrict network function and serial communication function even in the standby mode.

	LAN	RS232C	Keypad	IR Control
ECO	x	Δ	Δ	Δ
Network	x	▲	Δ	Δ
Normal	√	√	Δ	Δ

x: No Control      Δ: Power On command Only

▲: Power On command and Wake on LAN

√: All commands are active

### High land

Control the fan speed while cooling according the operating condition.

Off ... Normal speed. Set it so if the projector is operated at a lower altitude.

On ... Faster than Off. Set it so if the projector is operated at a higher altitude.

✓ Note:

- When operating the projector at an altitude around 1400~2700m, please setting as ON.

### Cooling fast

provides the following options in the cooling fans' operation after turning off the projector.

Normal .. As default cooling time.

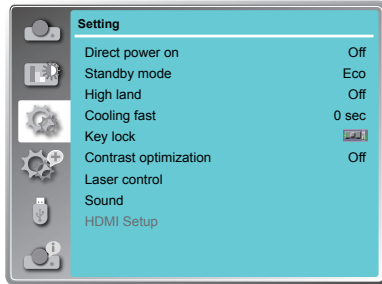

# OSD setting-Setting

30 sec ... Faster cooling time and louder noise of fan.

0 sec ..... Allow you to unplug the AC power cord immediately without cooling.

## Keylock

Set the security for the projector operation.



Off...The control panel and remote controller are effective.



Projector...Lock the operation of the control panel. Use the remote control to unlock.



Remote Control ...Lock the operation of the remote control. Use the control panel to unlock.

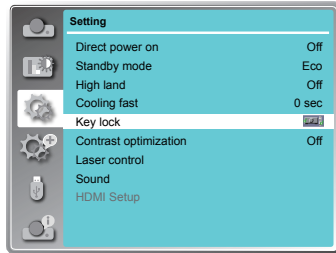

### ✓ Note:

- If the control panel accidentally becomes locked and you do not have the remote control nearby or there is something wrong with your remote control, contact the dealer where you purchased the projector or the service center.

## Contrast optimization

Select this function to optimize and compensate signal automatically on the basis of the image, to get the best contrast image.

On .... Increase the contrast of the image.

Off .... Disable this function.

## Laser Control

Modify the brightness according to the environment and the aim during the projectio.

### Light source mode:

Normal.....Normal brightness and enable the Laser adjust function.

Full Normal.....Normal brightness and disable the Laser adjust function

ECO.1/ECO.2...Lower the brightness and reduce energy consumption.

### Laser adjust.:

50% ~ 100% ....Arrange the brightness according the setting.

### ✓ Note:

This adjustment can only launched while the Light source mode as Normal.

## Sound

Adjust the volume.

Volume .... Press ▲ button to increase the volume, press ▼ button to decrease the volume.

Mute ..... Press ▼ button to switch mute function. (On/Off)

## HDMI setup (HDMI only)

Switch the settings of "Image" or "Sound" in "HDMI setup" menu, if the image is not projected properly.

### Image

64-940 ..... For the video device.

0-1023 ..... For the computer device.

### ✓ Note:

The optimal setting varies depending on the output setting of the connected external device.

Refer to the operation instruction of the external device regarding the output of the external device.

### Sound

HDMI ..... The image and audio are transmitted.

VGA ..... The audio signal is input by "AUDIO IN" terminal.

# OSD setting-Expand

## Expand

Select the Expand menu to set up other functions of your projector.

1. Press the MENU button on remote controller and the OSD displays. Press ▲▼ button to select Expand icon, press ► button or OK button to enter the submenu.
2. Press ▲▼ button to point to required item, press ► button or OK button to confirm your selection.
3. Press ▲▼ button to point to required item, press OK button to confirm your selection.

### Language

This projector provides multi-language screen menu.

You can press▲▼ button to select the language you want: English, German, French, Italian, Spanish, Polish, Swedish, Dutch, Portuguese, Japanese, Simplified Chinese, Traditional Chinese, Korean, Russian, Arabic, Turkish, Finnish, Norwegian, Danish, Indonesian, Hungarian, Czech, Kazakh, Vietnamese, Thai and Farsi.

### Auto setup

Press AUTO button on the remote control to execute "Input search" and "Auto PC adj." functions.

### **Input search**

Allows you to automatically detect input signals. It stops when a signal is found. Press ▲▼ button to select an option below:

- On..... Enabled.
- Off..... Disabled.

### **Auto PC adj.**

- On..... Press the AUTO button on the remote control to enable Auto PC adj. function automatically.
- Off..... Cancel Auto PC adj. function.

### ✓ Note:

- "Input search" and "Auto PC Adj." cannot be set to "Off" at the same time. At least one of them is set to "On".
- The setting of "Input search" as "On", the projector would start searching input signal while power on the projector.

## Expand menu

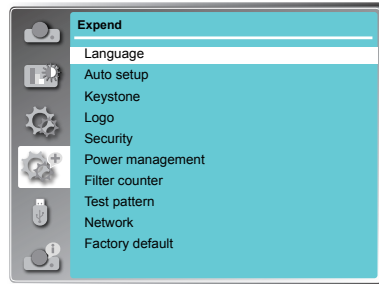

## Auto setup





# OSD setting-Expand

## Keystone

This function is used to correct the distortion image.

### Keystone

Sets whether or not to keep the keystone correction after turn off the projector or plug out the power cord.

**Store....** The keystone correction will be kept after unplug the power cord or turn off the projector.

**Reset...** The keystone correction will be canceled after unplug the power cord or turn off the projector.

### Keystone menu

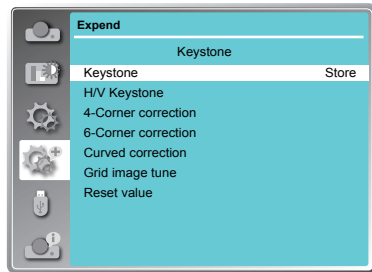

### H/V Keystone

Adjust when the horizontal or vertical trapezoid of the projected image is distorted.

Reduce the upper width with ▲ button.

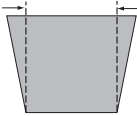

Reduce the lower width with ▼ button.

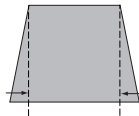

Reduce the left width with ◀ button.

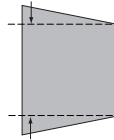

Reduce the right width with ▶ button.

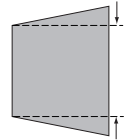

✓ Note:

- The white arrows indicate that there is no correction.
- A red arrow indicates the direction of correction.
- An arrow disappears at the maximum correction.

### 4-Corner correction

Adjust when the four corners of the projected image are distorted.

Press ▲ ▼ ◀ ▶ to adjust the item.

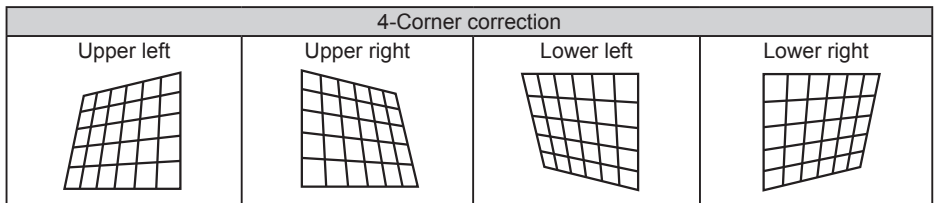

### 6-Corner correction

Adjust when the six corners of the projected image are distorted.

Press ▲ ▼ ◀ ▶ to adjust the item.

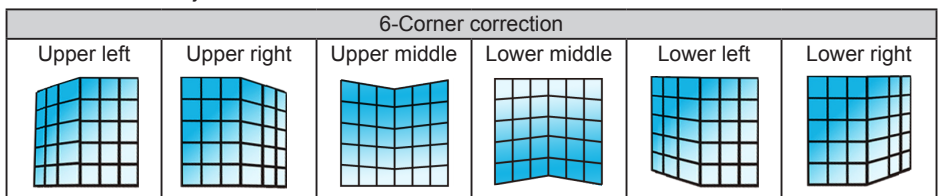



# OSD setting-Expand

## Curved correction

Adjust when the linearity is not uniform or the vertical and horizontal lines are distorted.

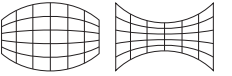
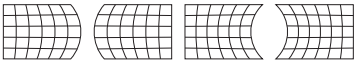
Press ▲ ▼ ◀ ▶ to adjust the item.

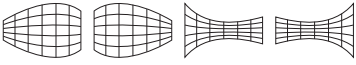
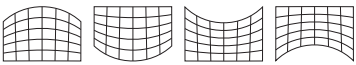
Items	Operation	Adjustment
Curved correction - X/Y Gain	Press the ◀ & ▶ button	Adjust the right & left of the width 
	Press the ▲ & ▼ button	Adjust the top & bottom of the width 
Curved correction - X Offset	Press the ◀ / ▶ button	Adjust the left / right of the distortion 
	Press the ▲ / ▼ button	Adjust the top / bottom of the distortion 
Curved Correction - Y Offset	Press the ◀ / ▶ button	Adjust the left / right of the distortion 
	Press the ▲ / ▼ button	Adjust the top / bottom of the distortion 

✓ Note:

- The adjusted value will be reset when you switch the keystone correction with another one.
- The "Curved Correction X Offset" and the "Curved Correction Y Offset" can not be adjusted independently. After adjusting the "Curved Correction X/Y Gain" at the beginning, please adjust the "Curved Correction X Offset" and "Curved Correction Y Offset".
- Correcting up to  $\pm 30^\circ$  for the tilt in the vertical direction and  $\pm 15^\circ$  for the tilt in the horizontal direction are available for adjustments with "Keystone". However, the image quality will degrade and it will get harder to focus with more correction. Install the projector so that the correction will be as small as possible.
- Screen size will also change when "H/V Keystone" is used to perform various adjustments.
- Aspect ratio of the image size may shift depending on the correction.

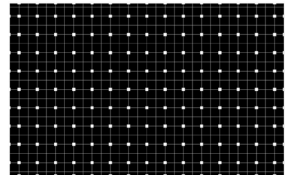

## Grid image tune

Correct the image via grid point.

Press ▲ ▼ ◀ ▶ to adjust the selected grid point.

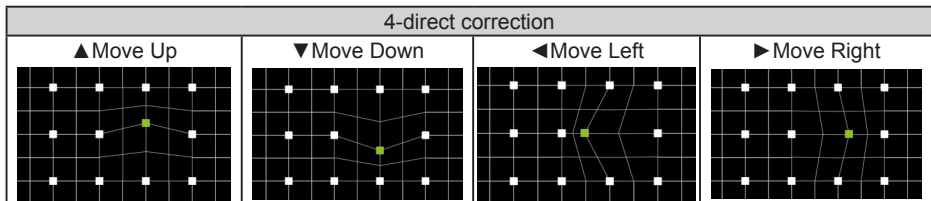

## Reset value

Return the corrected values to the factory default values.

Press ▲ ▼ to select "Reset value", and then press the OK button, the state of the keystone correction is released.

# OSD setting-Expand

## Logo

This function allows you to customize the screen logo with Logo select, Capture, Logo PIN code lock and Logo PIN code change functions.

### Logo Select

This function decides on the starting-up display from following options.

- Default . Show the factory-set logo.
- User..... Show the image captured by user.
- Off..... Show the countdown display only.

### Capture

You can capture a projected image as start logo . Select "Capture" and press the OK button on remote control or control panel.

Confirmation dialog box appears, select "Yes" to start capturing.

✓ *Note: The captured user logo image is deleted when factory default is executed.*

Logo

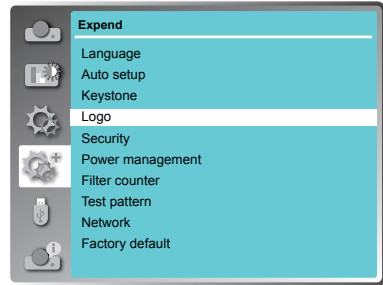

### Logo PIN code Lock

This function prevents an unauthorized person from changing the screen logo.

**Off** ..... The screen logo can be changed freely from the Logo menu.

**On** ..... The screen logo cannot be changed without a Logo PIN code.

If you want to change the Logo PIN code lock setting, press the OK button and the Logo PIN code dialog box appears. Enter a Logo PIN code by following the steps below. The default PIN code is "111".

Press OK button to enter the PIN code. Press ◀▶ button to select a number, and then press the OK button to enter this number, the cursor automatically move to next box. If you fixed an incorrect number, press MENU button to reset it again.

Repeat this step to complete entering a three-digit number.

After entering the three-digit number, the cursor automatically move to "Set", and press the OK button, then you can start to operate the projector.

If you entered an incorrect PIN code, the number (\*\*\*) turn red, it will be reset automatically within one second. Enter the correct PIN code all over again.

### Logo PIN code change

You can change the Logo PIN code (three number). Press the OK button to select Logo PIN code change. Logo Pin code dialog box appears, press ◀▶ button to enter the correct PIN code. The New Logo PIN code input dialog box appears. Set a new Logo PIN code, confirmation box appears, select Yes to set the new Logo Pin code.

Be sure to note the new Logo PIN code and keep it on hand. If you lost the number, you could no longer change the Logo PIN code setting.

## CAUTION:

**WHEN YOU HAVE CHANGED THE LOGO PIN CODE, WRITE DOWN THE NEW PIN CODE IN COLUMN OF THE LOGO PIN CODE NO. MEMO ON PAGE 77, AND KEEP IT SECURELY. SHOULD THE LOGO PIN CODE BE LOST OR FORGOTTEN, THE LOGO PIN CODE SETTING CAN NO LONGER BE CHANGED.**

# OSD setting-Expand

## Security

This function allows you to use the PIN code lock and PIN code change functions to set the security for the projector operation.

### PIN code lock

This function prevents the projector from being operated by unauthorized persons and provides the following setting options for security.

**Off** .... Unlocked.

**On** ....Enter the PIN code every time turning on the projector. If you want to change PIN code lock setting or PIN code, you must enter the PIN code.

The default PIN code is "111".

If you want to change the PIN code lock setting, press the OK button, then PIN code dialog box appears.

Press ◀▶ button to select a number, and then press the OK button to enter this number, the cursor automatically moves to next box. If you fixed an incorrect number, press MENU button to reset it again. Repeat this step to complete entering a three-digit number.

After entering the three-digit number, the cursor automatically move to "Set", and press the OK button, then you can change the PIN code lock setting.

If you entered an incorrect PIN code, the number (\*\*\*) turn red, it will be reset automatically within one second. Enter the correct PIN code all over again.

### PIN code change

The PIN code can be changed to three-digit number. Press ▲▼ button to select PIN code change. Pin code dialog box appears, Press ◀▶ button to enter the correct code. The New PIN code input dialog box appears. Set a new PIN code.

## Security



## CAUTION:

WHEN YOU HAVE CHANGED THE PIN CODE, WRITE DOWN THE NEW PIN CODE IN COLUMN OF THE PIN CODE NO. MEMO ON PAGE 77, AND KEEP IT SECURELY. SHOULD THE PIN CODE BE LOST OR FORGOTTEN, THE PIN CODE SETTING CAN NO LONGER BE CHANGED.

# OSD setting-Expand

## Power management

For reducing power consumption as well as maintaining the lamp life, the Power management function turns off the projection lamp when the projector is not operated for a certain period. Select one of the following options:

**Ready** - When the lamp has been fully cooled down, the POWER indicator changes to green blinking. In this condition, the projection lamp will be turned on if the input signal is reconnected or any button on the remote control or control panel is pressed.

**Power off** - When the lamp has been fully cooled down, the power will be turned off.

**Off** - Disable the Power management function.

**Timer** - If the input signal is interrupted and no button is pressed for more than 30 seconds, the timer display with No signal appears. It starts the countdown until the lamp is turned off. Press ▲▼ button to set the Timer(1~30min.)

**Ready countdown** - Set the time that ready status transfers to standby status automatically.(0-30min. 0 Min: not transfer automatically)  
In ready status, press POWER button to switch to standby status, and press any other button to turn on the projector.

## Filter counter

This function is used to set a frequency for filter cleaning.

When the projector reached a specified time between cleanings, a Filter warning icon appears on the screen, notifying the cleaning is necessary. After cleaning the filter, be sure to select RESET and set the timer. The Filter warning icon will not turn off until the filter counter is reset.

Filter counter.....Display the using time of the filter.

Timer.....Setting the timer for warning icon.

Filter counter reset .....Reset the value of counter after clean up the filter.

## Test Pattern

This function is used to set the internal test signal:  
Gray scale 1, Gray scale 2, Gray scale 3, Gray scale 4, Color bar, Red, Green, Blue, Cross hatch, White, Black and Raster gray.

## Power management

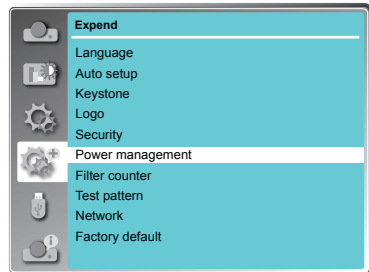

Time left before Lamp is off.

✓ Note:

Factory default: "Timer: 5 min",  
"Ready countdown: 5 min".

## Test Pattern

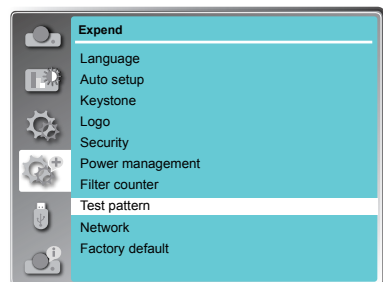

# OSD setting-Expand

## Network

Function : PC controls projector via LAN.

### Preparation:

1. Equipments: PC, projector, cables
2. Connection procedures:  
Connect the projector to routers or switches of the LAN by direct or cross cable. If it fails to connect PC and projector by parallel cable, please switch to cross cable as suggested.
3. After the computer is booted and the projector is plugged in, indicator lights of LAN interface on will flash continuously.

### Operation procedures:

- 1 Turn on the projector.
- 2 Obtain network address. DHCP set is displayed as On and obtain network address automatically. (If familiar with network, you can set DHCP as Off and obtain network address manually)
- 3 Enter network settings menu.
  - (1) Press MENU button on the remote control to display OSD menu. Press ▲▼ button to select Expand icon, and then press the OK button.
  - (2) Press ▲▼ button to select Network, and then press the OK button to enter the network menu.

**MAC address** ... Displays the MAC address of wired network of this projector.

**IP address** .....Displays the IP address of wired network of this projector.
  - (3) DHCP setting as On, IP address, Subnet, Gateway and DNS will be obtained automatically, press the OK at "Set" to confirm the parameters.  
DHCP setting as Off, press the OK button to enter IP address, then press ▼ button to enter Subnet, Gateway and DNS respectively, press the OK at "Set" to confirm the parameters.

✓ Note:

See page 50 for usage of Network.

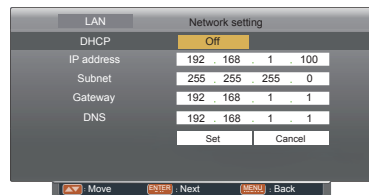
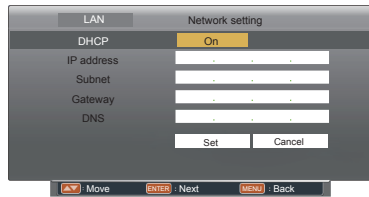
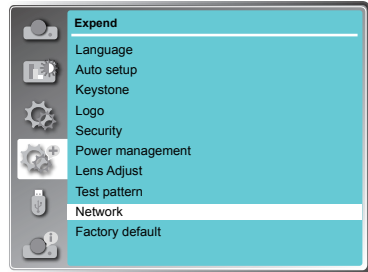

## Factory default

This function returns all setting values except for the PIN code lock, Logo PIN code lock, Lamp counter and Filter counter to the factory default settings.

# OSD setting-Memory Viewer

## Memory Viewer

The Memory Viewer function allow to project the pictures which are stored in the USB memory Device. This function only available when the USB memory device inserted into the projector.

- 1 Press MENU button on the remote control to display screen menu.
- 2 Press ▲▼ button to select "Memory Viewer", then press the OK button.
- 3 Press ▲▼ button to select the item you want to set, press the OK button.
- 4 Press ▲▼ button to adjust the item, then press the OK button.

### Set Slide

Start the slide show.

### Slide transition effect

Set the slide transition effect while the images switching as slide show.

Slide down.....Switch the image from the top to the bottom.

Slide right..... Switch the image from the left to the right.

Press▲▼ to select "Apply" and press the OK button to execute the setting.

### Sort Order

Set the sort order of the slide show.

Extend Order ....Sort files or folders in extended order.

Size Order .....Sort files or folders in amount of data order.

Time Order .....Sort files or folders in stored time order.

Name Order.....Sort files or folders in name order.

Press▲▼ to select "Apply" and press the OK button to execute the setting.

### Rotate

Set the rotate direction of image.

No Rotate ..... Rotate is disabled.

270 Degrees .... Rotate 270 degrees in anti-clockwise direction.

180 Degrees .... Rotate 180 degrees.

90 Degrees ..... Rotate 90 degrees in anti- clockwise direction.

Press▲▼ to select "Apply" and press the OK button to execute the setting.

### Best Fit

Set the image whether or not to fit with the projected screen.

On.....Display the image to fit with the aspect of the projected screen.

Off.....Display in the normal pixels of the image.

Press▲▼ to select "Apply" and press the OK button to execute the setting.

### Repeat

Enable or disable repeat function of the slide show.

On.....Display all of the files repeatedly.

Off.....Return to the thumbnail page after the last file is broadcasted.

Press▲▼ to select "Apply" and press the OK button to execute the setting.

### Apply

Execute the setting in slide show mode.

Press ▲▼ to select "Apply", then press the OK button, to launch the setting effect of slid show.

Memory Viewer menu

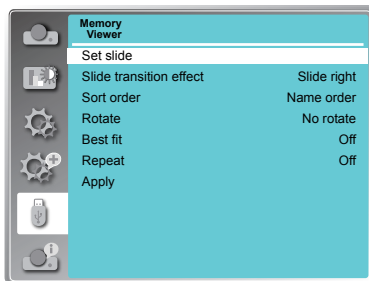

✓ *Note:*

- The "Memory Viewer" menu is available when select the input source as "Memory Viewer".

# OSD setting-Info.

## Information

The information menu is used to detect signal of projected image and running state.

### Menu operation

Press MENU button on the remote control or control panel to display the screen menu. Press ▲▼ to select Info., the information menu will appear as the right picture.

The status of projector will display in information menu.

### Input

The selected input source is displayed.

### H-sync freq .

The horizontal frequency of the input signal is displayed in KHz or --- -KHz when no signal is detected.

### V-sync freq .

The vertical frequency of the input signal is displayed in Hz or --- - Hz when no signal is detected.

### Light source counter

The usage time of the lamp is displayed.

### Power management

The setting status of "Power management" is displayed.

### Image mode

The setting status of "Image mode" is displayed.

### Firmware version

The information of firmware version.

info. menu





Description on using  
useful function

# Description on network control operation

## LAN control

Function : PC controls projector via LAN.

Preparation:

1. Equipments: PC, projector, cables
2. Connection procedures:

Connect the projector to routers or switches of the LAN by direct or cross cable. If it fails to connect PC and projector by parallel cable, please switch to cross cable as suggested.

3. After the computer is booted and the projector is plugged in, indicator lights of LAN interface and computer interface will flash continuously.

Operation procedures:

- 1 Turn on the projector.
- 2 Obtain network address. DHCP set is displayed as on and obtain network address automatically. If familiar with network, you can set DHCP as close and obtain network address manually.

- 3 Enter network settings menu.

(1) Press MENU button on control panel or remote control to display screen menu. Press ▲▼ button to select "Expand" icon, then press the OK button.

(2) Press ▲▼ button to select "Network" setting and press the OK button enter the network setting.

(3) Press ▲▼ button to set DHCP as on.

(4) Press ▲▼ button to "Set" and press the OK button. "Please wait..." appears.

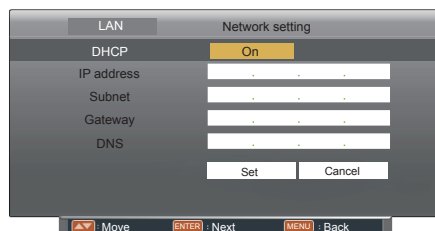
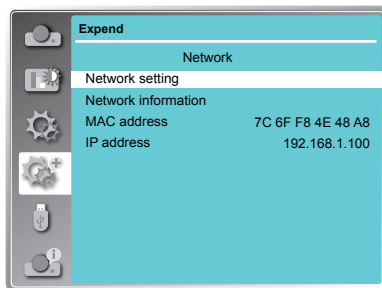

# Description on network control operation

4. Activate the Web browser in the personal computer.
5. Enter the IP address + /html (i.e. "192.168.1.100/html") set by the projector into the URL input field of the Web browser.  
(When entering the IP address only, Web browser will open Crestron Roomview page.)
6. Select "Login" to login the Network Display System page. (Both the initial name and passwords are "admin".)



✓ **Note:**

- You can click the upper right corner of the web browser screen to select the display language.
  - Do not perform setting or control simultaneously by starting up multiple web browsers. Do not set or control the projector from multiple computers.
  - Change the password first. (8 half-width characters).
  - If the screen for the web control is not displayed, consult your network administrator.
7. Items in Network Display System page including: "System Status", "General Setup", "Picture Setup", "Image Setup" and "Network Setup".

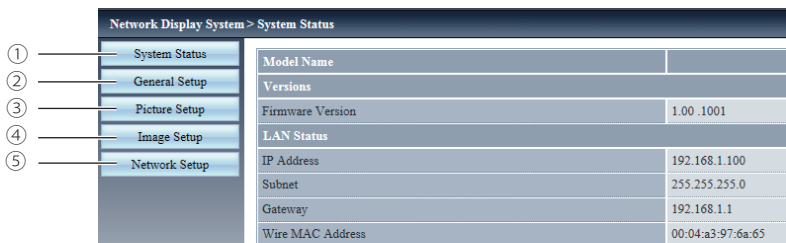

① System Status  
The "System Status" page is displayed by clicking this item.

② General Setup  
The "General Setup" page is displayed by clicking this item.

③ Picture Setup  
The "Picture Setup" page is displayed by clicking this item.

④ Image Setup  
The "Image Setup" page is displayed by clicking this item.

⑤ Network Setup  
The "Network Setup" page is displayed by clicking this item.

# Description on network control operation

## "System Status" page

Display the status of the projector for the following items.

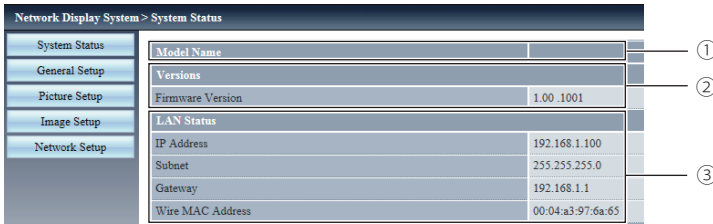

- ① Model Name  
Displays the model No. of the projector.
- ② Versions  
Displays the version of the firmware of the projector.
- ③ LAN Status  
Displays the connection status of the LAN.

## "General Setup" page

Change Password for Webpage is displayed.

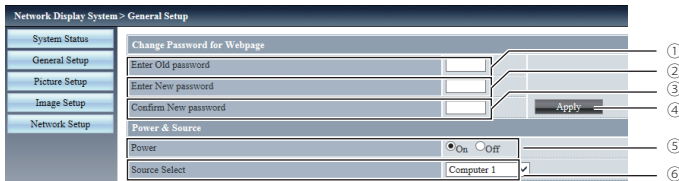

- ① Enter Old password  
Enters the configured password.
- ② Enter New password  
Enters the new password.
- ③ Confirm New password  
Enters the wanted new password again for confirmation.
- ④ Apply  
Updates the settings.
- ⑤ Power  
Switches on/off the power of the projector.
- ⑥ Source Select  
Switches the input source of the projector.

## "Picture Setup" page

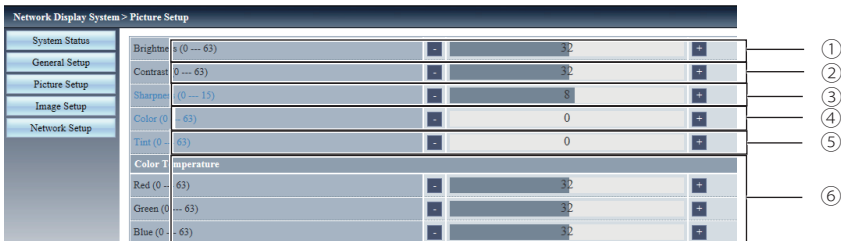

# Description on network control operation

- ① Brightness  
Adjusts the brightness of the projected image.
- ② Contrast  
Adjusts the contrast of the projected image.
- ③ Sharpness  
Adjusts the sharpness of the projected image.
- ④ Color  
Adjusts the color saturation of the projected image.
- ⑤ Tint  
Adjusts the skin tone of the projected image.
- ⑥ Color Temperature  
Adjusts the color temperature of the projected image.

## "Image Setup" page

System Status	Aspect	Normal
General Setup	Fine sync (0 --- 31)	0
Picture Setup	H Position	0
Image Setup	V Position	0
Network Setup	H Size (-15 --- 15)	0
	Freeze	<input type="radio"/> On <input checked="" type="radio"/> Off
	Y Keystone (-60 --- 60)	0
	H Keystone (-30 --- 30)	0
	Curved correction XGain (-40 --- 40)	0
	Curved correction YGain (-40 --- 40)	0
	Curved correction XOffset_x (0 --- 1279)	640
	Curved correction XOffset_y (0 --- 799)	400
	Curved correction YOffset_x (0 --- 1279)	640
	Curved correction YOffset_y (0 --- 799)	400
	Corner correction TopLeft_x (0 --- 1279)	0
	Corner correction TopLeft_y (0 --- 799)	0
	Corner correction TopRight_x (0 --- 1279)	1279
	Corner correction TopRight_y (0 --- 799)	0
	Corner correction BottomLeft_x (0 --- 1279)	0
	Corner correction BottomLeft_y (0 --- 799)	799
	Corner correction BottomRight_x (0 --- 1279)	1279
	Corner correction BottomRight_y (0 --- 799)	799

- ① Aspect  
Switches the aspect of the projected image.
- ② Fine sync  
Adjusts the fine sync of the projected image.
- ③ H Position  
Adjusts the horizontal position of the projected image.
- ④ V Position  
Adjusts the vertical position of the projected image.
- ⑤ H.Size  
Adjusts the total number of dots of the projected.
- ⑥ Freeze  
Switches the freeze function between on and off.
- ⑦ Auto PC adj.  
Executes the Auto PC adj. function.
- ⑧ V Keystone  
Corrects the keystone in vertical direction.
- ⑨ H Keystone  
Corrects the keystone in horizontal direction.
- ⑩ Curved Correction  
Corrects the pincushion or barrel of the projected image.
- ⑪ Corner correction  
Corrects the four corners of the projected image.

# Description on network control operation

"Network Setup" page

Network Display System > Network Setup

System Status

General Setup

Picture Setup

Image Setup

Network Setup

LAN Setup

Obtain an IP address automatically  Use the following IP address

IP Address	192	168	0	100
Subnet	255	255	255	0
Gateway	192	168	0	1
DNS	192	168	0	1

Apply

①

②

## ① LAN Setup

Select [Obtain an IP address automatically] if you want to enable the DHCP client.

### IP Address

Enter the IP address when not using a DHCP server.

### Subnet

Enter the subnet mask when not using a DHCP server.

### Gateway

Enter the default gateway address when not using a DHCP server.

### DNS

Enter the DNS server when not using a DHCP server.

## ② Apply

Updates the settings.

# Description on network display operation

## Network Display function

1. PwPresenter software: when "Network" is selected in Source Select, you can project the current computer images via network.

Input the IP address of the projector in webpage to enter the Network Display System, click "Download" to download the PwPresenter software according to your operation system.

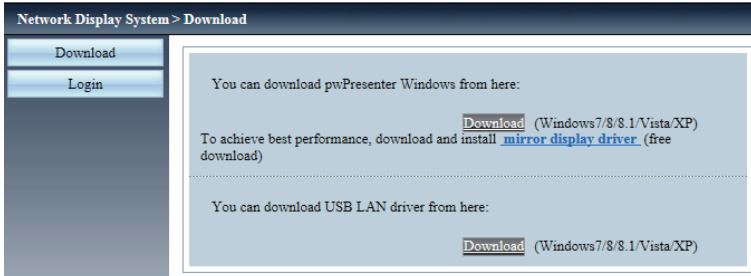

2. Launch the pwPresenter software.

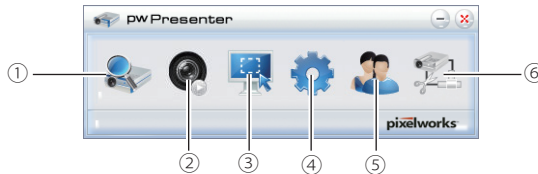

① Search for projector display  
Click to enter Search, select the projector and connect it. Please setting the same IP address of the projector in pwPresenter software, (such as: 192.168.1.100). Both the initial name and passwords are "admin".

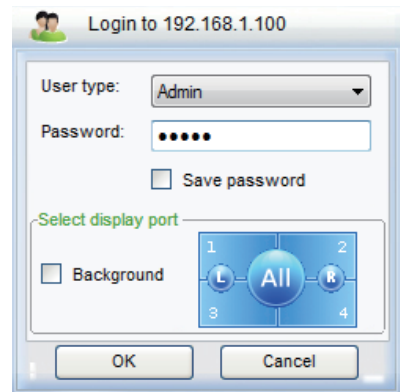
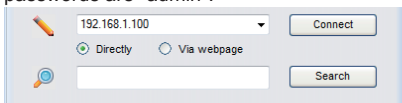

✓ *Note:*

- Before use PwPresenter software to search, you need change Source Select to "Network".

# Description on network display operation

## ② Play/Pause

Play or pause the selected image.

## ③ Choose capture mode

Choose a capture mode from "Full Screen", "Fixed Size" or "Alterable."

## ④ Parameters Setting

### Basic Setting

Setting language, region of capture image etc.

The screenshot shows the 'Basic Setting' dialog box with the following options:

- Language select: English
- Region size of fixed size capture mode: 800 x 600 (pixels)
- Enable mirror driver when startup if there is.
- Allow notification message popup:  Yes  No
- Data Transfer Encryption:  None  Partial  Full
- Software Information:
  - Version number: pwPresenter PCS1.0
  - Manufacturer: Pixelworks
  - Frame rate: [ ]

Buttons: OK, Apply, Cancel, Default

### Advanced Setting

Setting image quality, network port etc.

The screenshot shows the 'Advanced Setting' dialog box with the following options:

- .jpeg image setting:
  - Quality: High
  - YUV sample format:  YUV444  YUV420
- .Network port setting:
  - Fixed  Manual 5900
- Allow resolution to be changed:  Yes  No
- .White list and Black list:
  - Devices allowed: [ ]
  - Devices banned: [ ]

Buttons: OK, Apply, Cancel, Default

### Global Setting

Setting remote control, capture by audio or screen etc.

The screenshot shows the 'Global Setting' dialog box with the following options:

- Allow remote control:  Yes  No
- Allow audio capture:  Yes  No
- Allow screen capture:  Yes  No
- Sound volume: [ ] 20 %
- Mode: Video

Buttons: OK, Apply, Cancel, Default



# Description on network display operation

## Multicast Setting

Setting Sound volume, Bandwidth and Capture rate etc.

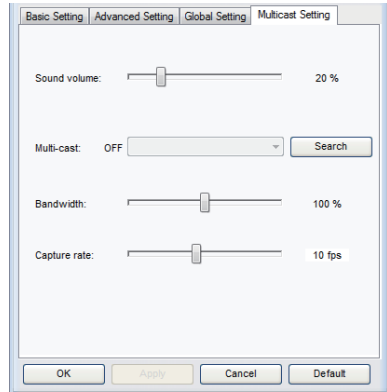

- ⑤ Network Display Management  
Setting device and password management.

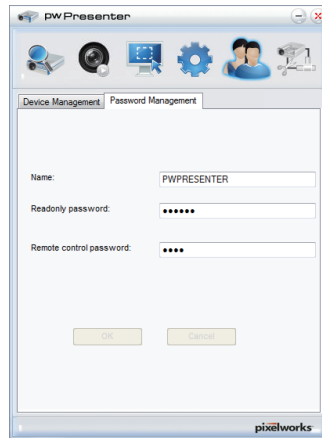
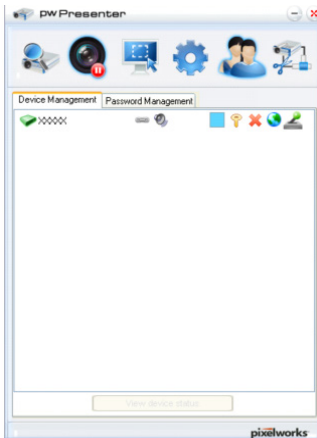

- ⑥ Disconnect the projector.

# Description on using Memory Viewer function

## Memory Viewer function

The Memory Viewer function is used to project the pictures which are stored in the USB memory when the USB memory is inserted into USB A(VIEWER) terminal of the projector.

Memory Viewer function supports the following image files.

	Extension	Format	Description
Picture	jpg/jpeg	Baseline encoder 24 bit	Max. resolution : 10000 x 10000
		Progressive RGB 24 bit	Max. resolution : Panel Resolution
	bmp	1, 4, 8 bit Palette-based RGB 24, 32 bit	Max. resolution : 1280 x 800
	png	24, 48 bit True color	24 bit color palette space Max. resolution : 1024 x 768
	gif	1, 4, 8 bit Palette-based	Max. resolution : 800 x 600
	tiff	—	Max. resolution : 800 x 600

### Display the Memory Viewer screen

1. Press the INPUT button on the remote control or on the control panel to select the input source as Memory Viewer.
2. Insert the USB memory into the USB-A terminal of the projector directly, the standby screen appears when the USB memory icon is displayed on the screen.
3. Press the OK button on the remote control, the root directory of the USB memory will show as thumbnail on the screen.

### Play the pictures

It will display a picture when play the picture manually every time.

1. Press ▲▼◀▶ to select a file on the thumbnail screen.
2. Press the OK button, the picture will display on the full screen.
3. Press ▶ to switch to the next picture, press ◀ to return to the previous picture.
4. Press the OK button on the remote control to return to thumbnail screen.

### Executing the slide

All pictures in the same folder will play automatically when "Slide Transition Effect" of "Memory Viewer" menu is set to the special setting.

1. Press ▲▼◀▶ to select a file.
2. Press the "MENU" button to select the "Memory Viewer" → "Set Slide".
3. Press the OK button.
  - The picture will display on the full screen.
  - Press the OK button to return to the thumbnail screen.

# Description on using Memory Viewer function

## **Play the PDF**

Playing the PDF file.

press ▲▼◀▶ to select a PDF file and press the OK button, playing the PDF on the full screen.



	Displays the previous or next page.
	The page number increases or decreases by 5 pages.
	The page number increases or decreases by 1 page.
	Jumps to page number directly.
	Switches PDF file between full screen display or whole page display.
	Switches the display size on 3 levels of magnification. Press ▲▼ on the remote control to move the display screen up and down.
	Remove the display screen up, down, left and right by ▲▼◀▶ button on the remote control.
	Exit the PDF file, and return to the thumbnail screen.

## **Termination of the Memory Viewer**

1. Press ▲▼◀▶ to the thumbnail which is displayed on the upper left corner.
2. Press the OK button on the remote control to return to the standby screen of Press "OK".
3. Remove the USB memory directly.

# Description on using USB display function

## USB Display function

The USB Display function is used to project the image from the computer which is connected to USB-B (DISPLAY) terminal of the projector by a USB converting cable.

### ■ When using Windows

Windows operation environment

OS	Windows XP, Windows7 32/64 bit, Windows8.1 32/64 bit, Windows10 32/64 bit
CPU	Intel Core 2 Duo 2.0 GHz or faster compatible processor
Amount of memory	256 MB or more (Recommended : 512 MB or more)
Hard-disk free space	20 MB or more
Display	Resolution 640 x 480 to 1600 x 1200

- There is no guarantee for all computers that meet the above conditions will operate properly.

### Projecting the USB Display

1. Connect the USB-B terminal of the projector to a computer with a USB converting cable.
2. Press the Input button on the remote controller or control panel to switch the input source as USB Display.
  - The startup screen will be displayed automatically due to the driver which is built-in the projector, and executes the installation according to the instructions of the screen. The displaying of the auto installation screen depends on the setting of computer. At this time, please select "Run autorun.exe". Please double-click "autorun.exe" in the folder of the USB Display when the automatically startup is disabled.
  - The image on the computer screen is projected.
3. Click the driver icon  in the task bar of computer and select one item in Pop-up menu.
  - Pop-up menu is only displayed in English.
  - The item which is displayed in gray is unavailable.

Active audio/ Disable audio	Set whether to output the audio from the computer.
Play video/ Pause video	Switch between play and pause the image.
Start/Stop	Set whether to display the image from the computer.
Exit	Exit USB Display.

### ✓ Note:

- The driver is not installed in your computer, and it will be removed from the computer when disconnecting the USB cable.
- It will take a while when you want to project the computer screen.
- Connect a USB cable directly to the USB connector of a computer. It will not work when connecting through a USB hub.

### Termination of the USB display

When terminate the USB display, remove the USB cable directly. There is no need to follow "Remove hardware safely" when a USB cable is disconnected.

# Description on using USB display function

## ■ When using Mac OS

Mac OS operating environment

OS	Mac OS X 10.5, 10.6, 10.7, 10.8, 10.10, 10.11, 10.12, 10.13
CPU	Power PC G4 1GHz or faster
Amount of memory	512 MB or more
Hard-disk free space	20 MB or more
Display	Resolution 640 x 480 to 1600 x 1200

- There is no guarantee for all computers that meet the above conditions will operate properly.

### **Projecting the USB Display**

1. Connect the USB-B terminal of the projector to a computer with a USB converting cable.
2. Press the INPUT button on the remote control or Control panel to switch the input source to USB Display.
  - The image on the computer screen is projected.
3. Double-click "Monitor.app" in the virtual disk that has been mounted.
4. Right-click the driver icon  in the dock of computer and select one item in Pop-up menu.
  - Pop-up menu is only displayed in English.
  - The item which is displayed in gray is unavailable.

Active audio/ Disable audio	Set whether to output the audio from the computer.
Play video/ Pause video	Switch between playing and pausing the image.
Start/Stop	Set whether to display the image from the computer.
Quit	Terminate the USB Display.

✓ Note:

- It will take a while when you want to project the computer screen.
- Connect a USB cable directly to the USB connector of a computer. It will not work when connecting through a USB hub.

### **Termination of the USB display**

When terminate the USB display, remove the USB cable directly.

# Maintenance

This chapter describes the regular maintenance procedure of your projector to ensure its optimal operation status for long.

# Regular maintenance

## LED indicator

The LED indicator shows status of projector protection function. Check POWER, STATUS and LIGHT indicator for good maintenance operation.



Note:

Unplug the AC power cord in case of any abnormality as it may lead to fire or electric shock.

The projector turns off and the POWER indicator fast blinking red.

Your projector is powers off automatically to protect components within it when it detected the internal temperture has overheated. The POWER indicator blinking green while the projector is cooling down. Press the STAND-BY button to power your projector on again when it is cooled down to normal operation temperature.

Check the following:

- Is adequate clearance provided for your projector's ventilation? Check the installation status and any air outlet block.
- Is your projector installed at location close to outlet of air conditioning equipment? Keep your projector away from air outlet of air conditioning equipment.
- Is the filter in clean condition? Please clean the filter regularly.

The Power indicator blinking red

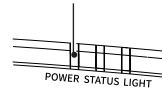

✓ Note:

The POWER indicator stops Blinking when your projector's internal temperature cooled down to normal and it can powered on again.

The projector powers off and the POWER indicator turns red, the STATUS indicator blinking red.

The POWER indicator turns red and the STATUS indicator start blinking red, then the projector powers off to protect its internal components whenever an abnormality is detected. Unplug the AC power cord and connect again. Restart your projector and run checkup routine. If the problem persists, unplug the AC power cord and call your service center for checkup and maintenance.

The POWER indicator stays red

The STATUS indicator blinking red

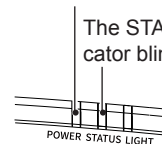

# Regular maintenance

Clean your projector when it is contaminated by foreign matter or its display effects are getting worse.



Note:

Unplug the AC power cord before any cleaning operation.

## Clean casing of your projector

Wipe the casing surface with clean and soft cloth. Gently wipe the casing with clean and soft cloth dampened with small amount of neutral detergent to remove heavy dirt. Do not over apply cleaner to the casing. Abrasive cleaner, solution, or other rough chemical may scratch the casing surface.

Place your projector in proper container after use to protect it from dirt and dust and being scratched.

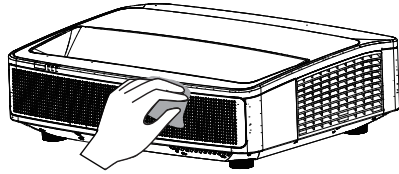

## Clean the filter

The filter is designed to keep dust from entering in your projector, which may lead to dusts accumulated on surface of internal components. Clogged filter may reduce cooling fan effects, which, in turn, will overheat your projector and shorten its life cycle. Clean the filter immediately whenever the Filter Warning icon displays.

Please follow these steps to clean your filter:

- 1 Power off your projector and unplug from AC power source.
- 2 Release the screw at bottom case and then remove the filter cover to take the filter out.
- 3 Gently clean the filter with a brush.
- 4 Insert the filter. Make sure it has been fully inserted.

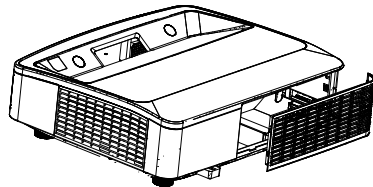

Note:

Do not insert any small object in the air outlet. It may fail your projector.



## Appendix

# Appendix

## Troubleshooting

Check the following before calling your dealer or service center:

Troubleshooting	Solution
Power on failure	<ul style="list-style-type: none"><li>– Plug the power cord of your projector in an AC socket.</li><li>– Check the POWER indicator flash red.</li><li>– Check the POWER indicator lighting red and STATUS indicator flashing red.</li><li>– Disable the Key Lock function of your projector.</li></ul>
The Logo screen differs from the standard settings.	<ul style="list-style-type: none"><li>– Make sure you did not select User or Off in the Logo Select selection.</li></ul>
Input signal switch (or do not switch) automatically.	<ul style="list-style-type: none"><li>– Make sure you have correctly set up the Input Search function at Auto setup menu.</li></ul>
Image looks fuzzy	<ul style="list-style-type: none"><li>– Adjust the focus of the projection image.</li><li>– Provide proper projection distance.</li><li>– The projection lens requires cleaning.</li><li>– Moving your projector from a colder environment to a hotter one may result in condensing on the lens. If this is the case, wait until the condensing water evaporated before powering on your projector.</li></ul>
Image mirror reflected / Image turns upside down	<ul style="list-style-type: none"><li>– Check the Ceiling and Rear settings.</li><li>– Check the Ceiling settings.</li></ul>
Image looks dim	<ul style="list-style-type: none"><li>– Check the contrast and brightness settings.</li><li>– Check for correct image mode settings</li><li>– Check the laser control settings.</li></ul>
No image displays	<ul style="list-style-type: none"><li>– Check for the connection between your projector and computer or image equipment.</li><li>– Check for correct input signal from computer. Connection with certain notebook / computer may mandate changes to its display output settings. See the user manual included with the computer for details on settings.</li><li>– It takes about 10 seconds for your projector to show the first image.</li><li>– Check the setting of signal, color system, image system, or computer system.</li><li>– Make sure the ambient temperature is within given range (41°F–95°F; 5°C–35°C).</li><li>– Image does not display in BLANK mode. Press the BLANK button or other buttons on the remote controller to display the image.</li></ul>
Abnormal color	<ul style="list-style-type: none"><li>– Check the setting of signal, color system, image system, or computer system.</li><li>– Make sure Blackboard mode is not selected in Image mode.</li></ul>
Some operations are invisible	<ul style="list-style-type: none"><li>– Check the display function.</li></ul>

# Appendix

Auto PC Adjusting function failure	– Check input signal. Auto PC Adjusting function is disable in 480p, 576p, 720p, 480i, 576i, 1080i or 1080p mode.
Settings do not save after power off	– Make sure you have selected Store after settings the adjustment. Some settings do not keep without selecting with Store.
Power management failure	– In case of Freeze or Blank operation, the power management function does not work.
Auto Setting does not work	– Make sure it is not set to "Off" in each selection at the "Auto setup" menu.
Image distorted or disappeared	– Check and revise the PC Adj. menu or Screen menu.
A password prompt displays after power on	– You have enable the Logo PIN Code lock function
Remote controller does not work	– Check the battery. – Make sure there is no obstacles stand in between your projector and the remote controller. – Make sure the remote controller is not too far away from your projector. – Disable the key lock of the remote controller in the Security menu.
LED indicator turns on or flashes	– Check status of your projector according to the light indicator status.
Exclamation mark displays	– Invalid operation, please operate your projector correctly.
Control panel does not work	– Disable the key lock on control panel function in the Security menu.
Cannot disable the Logo Select password, Key Lock, and PIN Code lock function	– Please call your dealer or contact the service center.

- Make sure your projector is correctly connected to external equipment.
- Make sure all devices have plugged in an AC power source and have been powered on.
- If your projector fails to project image of the connected computer, restart the computer.













































## Warning:

Your projector employs high voltage power for operation. Do not open its casing. If the problem persists, call your dealer or service center. Along with model number of your projector and a description to your problem. You will be advised on getting our services.











































# Appendix

## LED indicator status

Check LED indicator to learn status of your projector.

Light indicator			Status of your projector
POWER Green / Red / Orange / Blue	STATUS Green / Red / Orange	LIGHT Green / Red / Orange	
			Power Off (without AC power supply).
			Network Standby status. Press the Power button to turn it on.
 (1.5 sec. on 7.5 sec. off)			ECO Standby status. Press the Power button to turn it on.
 (1.5 sec. on 1.5 sec. off)			Normal Standby status. Press the Power button to turn it on.
		 (2.5 sec. on 0.5 sec. off)	Laser Light Source lighting on. (Laser Power setting as ECO1 / ECO2)
			Laser Light Source lighting on. (Laser Power setting as Normal)
 (0.5 sec. on 0.5 sec. off)			Booting up.
 (0.5 sec. on 0.5 sec. off)			Cooling down.
			Fail to launch the function while you press the control panel with the "Key Lock" setting as "Projector".
 (0.5 sec. on 0.5 sec. off)		 (0.5 sec. on 0.5 sec. off)	Laser Light Source is lighting up again after the failure of lighting up.
		 (0.5 sec. on 0.5 sec. off)	The Light Source has reached the life time. Please replace the Laser Light Source
		 (0.5 sec. on 0.5 sec. off)	Laser Light Source over time warning. Please replace the Laser Light Source
 (0.5 sec. on 0.5 sec. off)			Abnormal temperature detected and power off automatically.
 (0.5 sec. on 0.5 sec. off)			The current value of Laser Light Source driver is too low
 (0.5 sec. on 0.5 sec. off)	 (0.5 sec. on 0.5 sec. off)		The SPI communication of Laser Light Source driver is error.

# Appendix

 (0.5 sec. on 0.5 sec. off)		 (0.5 sec. on 0.5 sec. off)	The Laser Light Source driver get into standby mode caused by the error situation.
 (0.5 sec. on 0.5 sec. off)		 (1.5 sec. on 1.5 sec. off)	The output current of Laser Light Source driver is abnormal
 (0.5 sec. on 0.5 sec. off)		 (2.5 sec. on 0.5 sec. off)	The Laser Light Source driver status error
 (0.5 sec. on 0.5 sec. off)	 (1.5 sec. on 1.5 sec. off)		The voltage of Laser Light Source driver error
 (0.5 sec. on 0.5 sec. off)	 (2.5 sec. on 0.5 sec. off)		The Laser Light Source driver fail to start.
			The FAN-1 status error.
	 (0.5 sec. on 0.5 sec. off)		The FAN-2 status error.
		 (0.5 sec. on 0.5 sec. off)	The FAN-3 status error
	 (1.5 sec. on 1.5 sec. off)		The FAN-4 status error.
		 (1.5 sec. on 1.5 sec. off)	The FAN-5 status error
	 (2.5 sec. on 0.5 sec. off)		The FAN-6 status error.
	 (0.5 sec. on 0.5 sec. off)		The Power status error
 (0.5 sec. on 0.5 sec. off)	 (0.5 sec. on 0.5 sec. off)		The Color Wheel status error
	 (2.5 sec. on 0.5 sec. off)		Filter over time warning.



Off



Lighting



Flashing



Lighting



Flashing



Lighting



Flashing



Lighting



Flashing

# Appendix

## Compatible computer screen

Your projector is designed to accept every analog computer signal below Dot Clock 160MHz and digital computer signal below Dot Clock 150MHz.  
See table below for details on resolution and relevant frequency.

Input	Signal format	Resolution	Frequency (Hz)
RGB	NTSC	720x480i	60
		720x576i	50
	480p	720x480	60
		720x576	50
	720p	1280x720p	50
		1280x720p	60
	1080i	1920x1080i	50
		1920x1080i	60
	1080p	1920x1080p	24
		1920x1080p	50
		1920x1080p	60
	VGA	640x480	60
		640x480	67
		640x480	72
		640x480	75
		640x480	85
	SVGA	800x600	56
		800x600	60
		800x600	72
		800x600	75
	MAC 16	800x600	85
		832x624	75
	XGA	1024x768	60
		1024x768	70
		1024x768	75
		1024x768	85
	XGA+	1152x864	70
		1152x864	75
	WXGA	1280x720	60
		1280x768	60
		1280x768	75
		1280x768	85
		1280x800	60
		1280x800	75
		1280x800	85
		1360x768	60
	1366x768	60	
	MSXGA	1280x960	60
		1280x960	75
	SXGA	1280x1024	60
		1280x1024	65
		1280x1024	72
		1280x1024	75
	1280x1024	85	



  

Input	Signal format	Resolution	Frequency (Hz)	
RGB	SXGA+	1400x1050	60	
		1400x1050	75	
		1440x900	60	
	UXGA	1600x1200	60	
		1600x900	60	
	WSXGA+	1680x1050	60	
		1920x1080	60	
	WUXGA	1920x1200	60	
1920x1200		60		
HDMI	NTSC	720x480i	60	
		PAL	720x576i	50
		480p	720x480	60
		576p	720x576	50
		720p	1280x720p	50
	720p	1280x720p	60	
		1920x1080i	50	
		1920x1080i	60	
	1080p	1920x1080p	24	
		1920x1080p	50	
		1920x1080p	60	
	VGA	640x480	60	
		SVGA	800x600	60
	XGA	1024x768	60	
		1280x720	60	
		1280x768	60	
		1280x800	60	
		1360x768	60	
	WXGA	1366x768	60	
		MSXGA	1280x960	60
	SXGA	1280x1024	60	
		SXGA+	1400x1050	60
	UXGA	1440x900	60	
		1600x1200	60	
WSXGA+	1600x900	60		
	1680x1050	60		
WUXGA	1920x1080	60		
	1920x1200	60		
4K	3840x2160	30		

✓ Note:  
Changes to this manual may be made without notice.

# Appendix

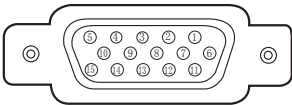
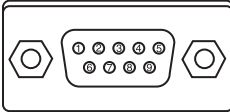
## Terminal configuration

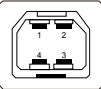
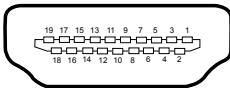
VGA IN / VGA OUT Terminal (D-sub 15)			
	1	Red (Input/output)	9 -----
	2	Green(Input/output)	10 Grounding (field synchronizing)
	3	Blue(Input/output)	11 Grounding
	4	-----	12 DDC data
	5	Grounding (line synchronizing)	13 Horizontal synchronizing (compound sync.)input/output
	6	Grounding(red)	14 Vertical synchronizing input/output
	7	Grounding(green)	15 DDC Clock
	8	Grounding(blue)	
SERIAL Terminal(D-SUB 9)			
	1	-----	6 -----
	2	RXD	7 -----
	3	TXD	8 -----
	4	-----	9 -----
	5	GND	
LAN Terminal			
	1	TX +	5 -----
	2	TX -	6 -----
	3	-----	7 RX +
	4	-----	8 RX -
USB-B Terminal			
	1	V Bus	3 Data +
	2	Data -	4 GND
HDMI Terminal (HDMI Type A 19)			
	1	TMDS Data2+	11 TMDS Clock Shield
	2	TMDS Date2 Shield	12 TMDS Clock-
	3	TMDS Date2-	13 CEC
	4	TMDS Date1+	14 Reserved (N.C. on device)
	5	TMDS Date1 Shield	15 SCL
	6	TMDS Date1-	16 SDA
	7	TMDS Date0+	17 DDC/CEC Ground
	8	TMDS Date0 Shield	18 +5V Power
	9	TMDS Date0-	19 Hot Plug Detect
	10	TMDS Clock+	

# Appendix

## Menu tree

Main menu	Sub-menu	Setting	Default value	Remarks
Display	Auto PC adj.			
	Fine sync	0-31		
	H Position	-5 - +5		
	V Position	-5 - +5		
	H Size	-15 - +15		The range of H Size differs from signals.
	Aspect	Normal 16:9 16:10	16:10	
	Project way	Front Rear Ceiling / Front Ceiling / Rear Auto ceiling / Front Auto ceiling / Rear	Front	
	Menu position	Upper Left, Upper Right Center Lower Left, Lower Right	Upper Left	
Background display	Black Blue	Blue		
System				
Color adjust	Image mode	Dynamic Standard Cinema Blackboard (Green) DICOM Colorboard User Image	Standard	
	Contrast	0-63	32	PC Input
	Brightness	0-63	32	
	Color temp	High/Mid/Low	Mid	
	Red	0-63	32	
	Green	0-63	32	
	Blue	0-63	32	
Sharpness	0-15	8		



# Appendix

Main menu	Sub-menu	Setting	Default value	Remarks	
Setting	Direct power on	On/Off	Off		
	Standby Mode	Normal/Eco mode	Eco		
	High land	On/Off	Off		
	Cooling fast	Normal/0 Sec/30 Sec	0 Sec		
	Key lock	Off/Projector/Remote controller	Off		
	Contrast Optimization	On/Off	Off		
	Laser Control	Light source mode	Boost/Normal/Eco 1/Eco 2	Normal	
		Laser Adjust		100%	
	Sound	Volume	0 - 25	13	
		Mute	On / Off	Off	
	HDMI Setup	Image	64-940	0-1023	
			0-1023		
		Sound	HDMI VGA	HDMI	
	Expand	Language	26 Languages	English	
Auto Setup		Input Search	On/Off	On	
		Auto PC Adj.	On/Off	On	
Keystone		Keystone	Store / Reset	Store	
		H/V Keystone			
		4-Corner correction			
		4-Corner correction			
		Curved correction			
		Gride image tune			
		Reset value			
Logo		Logo select	Default/User/Off	Default	
		Capture			
		Logo PIN Code Lock	On/Off	Off	
		Logo PIN Code Change			
Security		PIN code lock	On/Off	Off	
		PIN code change			
Power management		Ready / Power off / Off / Timer / Ready Countdown		Ready	

# Appendix

Main menu	Sub-menu	Setting	Default value	Remarks	
Expand	Filter Counter	Filter counter			
		Timer			
		Filter counter reset			
	Test pattern	Off / Gray scale (1-4) / Color bar / Red / Green / Blue / Cross hatch / White / Black / Raster gray	Off		
	Network	Network setting	LAN		
			DHCP(On/Off)	Off	
			IP address	192.168.1.100	
			Subnet	255.255.255.0	
			Gateway	192.168.1.1	
		DNS	192.168.1.1		
		Network status	MAC address		
IP address	192.168.1.100				
Factory default					
Memory Viewer	Set slide				
	Slide transition effect	Slide down / Slide right	Slide right		
	Sort order	Extend name order / Size order / Time order / Name order	Name order		
	Rotate	No rotate / 270° Degree / 180° Degree / 90° Degree	No rotate		
	Best fit	On/Off	Off		
	Repeat	On/Off	On		
	Apply				
Info.	Input				
	H-sync freq.				
	V-sync freq.				
	Light source counter				
	Power Management				
	Image mode				
	Firmware version				

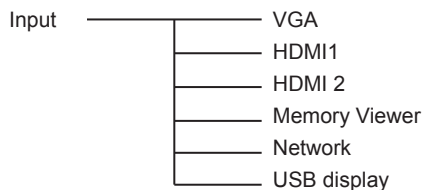

# Appendix

## Technical Specifications

### Mechanical properties

Dimensions (W×H×D )	521mmx165.5mmx435mm
Net Weight	11Kg
Adjustable foot	2'

### LCD resolution

LCD system	0.64" (WXGA / WUXGA) TFT
LCD resolution	1280X800 (WXGA) / 1920X1200 (WUXGA)

### Optical elements

Image size (diagonal)	85"-120"
Projection distance	WXGA / WUXGA: 5 ~ 164mm
Lens	F = 1.7 / f =2.94mm
Throw Ratio	WXGA/WUXGA: 0.235:1 (90" @ 45.6mm )
Contrast Ratio	5,000,000:1
Aspect Ratio	16:10 (WXGA / WUXGA)

### Terminal

VGA IN	Mini D-sub 15 pin x1
VGA OUT	Mini D-sub 15 pin x1
USB connector	USB-A x1, USB-B x1
LAN	RJ45 x1, 100 Base-TX (100Mbps)/10 Base-T (10Mbps)
HDMI IN	HDMI x2
AUDIO IN	3.5mm Mini Type Stereo x1
AUDIO OUT	3.5mm Mini Type Stereo x1
CONTROL terminal	D-sub 9 pin x1

### Power

Voltage and power consumption	AC 100–240 V, Max 4.5A, 50/60 Hz
-------------------------------	----------------------------------

### Operating Environment

Operating temperature	41°F-104°F (5°C-40°C)
Storage Temperature	14°F-122°F (-10°C-50°C)
High land	under 3000 m

### Remote control

Battery	AAA or LR3 1.5V ALKALINE TYPE x 2
Operating Range	16.4' (5 m)±30°
Dimensions	48mm (W) x 26mm (H) x 160mm (D)
Net Weight	67g (including batteries)

- The aforesaid specification is subject to change without prior notice.
- Liquid crystal panel is made on the basis of high standard, where 99.99% of the pixels are effective. Due to the nature of the liquid crystal panel, a fraction of the pixels (0.01% or less) may be ineffective.

# Appendix

## Dimensions

Unit: mm

↘ Screw Holes for Ceiling Mount  
Screw: M4  
Depth: 8.0

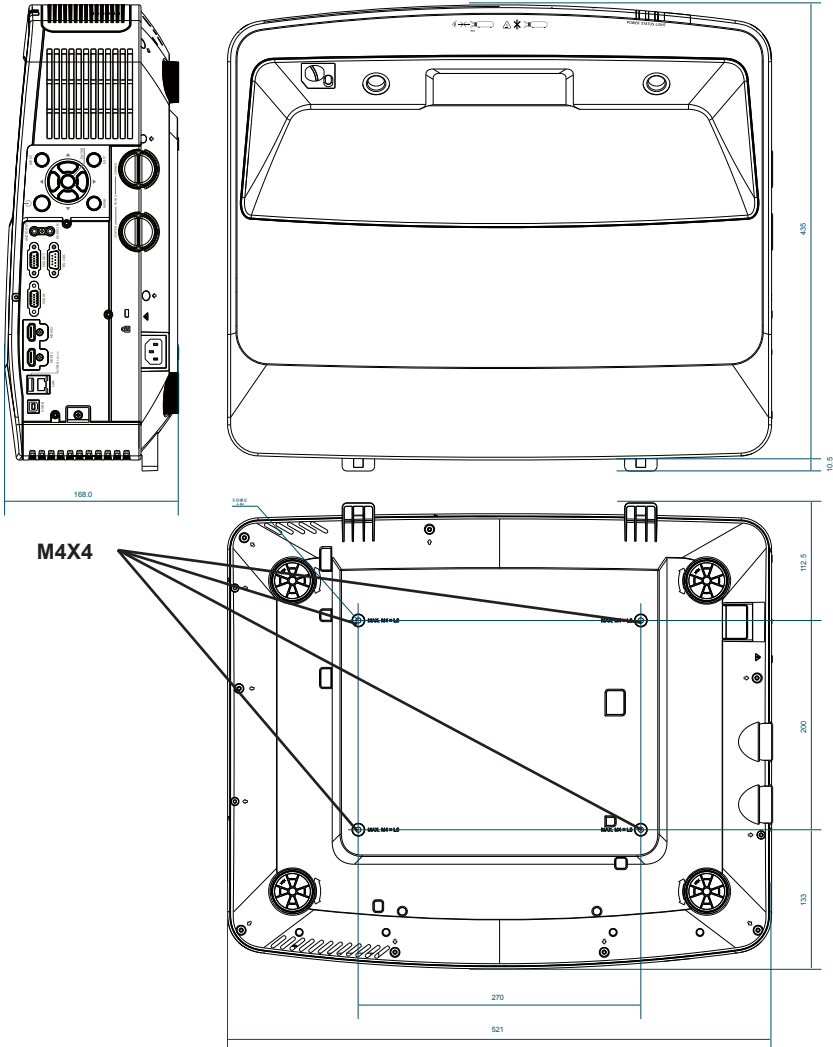

# Appendix

## PIN code memorandum

Write down the PIN code in the blank below and keep it, If you forgot or lost the number and unable to operate the projector, contact the service center.

PIN code lock

Factory default PIN code 111\*

--	--	--

Logo PIN code Lock No.

Factory default PIN code 111\*

--	--	--

\*If this 3-digit number is changed,  
the factory default number will be ineffective.

# EIKI

## U.S.A. / Canada

EIKI International, Inc.  
22552 Avenida Empresa Rancho  
Santa Margarita, CA 92688 U.S.A.  
Tel: +1 800-242-3454  
+1 949-742-6800  
E-Mail: usa@eiki.com

## China

EIKI (Shanghai) Co., Ltd.  
LAKESIDE OASIS MIDDLE RING  
BUSINESS CENTRE Block 1, Room 606,  
1628, Jin Sha Jiang Road  
Shanghai, 200333, CHINA  
Tel: +86 21-3251-3993  
Service Hot line: +86 21-3251-3995  
Fax: +86 21-3251-3997  
E-mail: info@eiki-china.com

## Deutschland & Österreich

EIKI Deutschland GmbH  
Am Frauwald 12  
65510 Idstein, Deutschland  
Tel: +49 6126-9371-0  
Fax: +49 6126-9371-11  
E-Mail: info@eiki.de

## Eastern Europe

EIKI CZECH SPOL. s.r.o.  
Nad Cementárnou 1163/4a  
Praha 4, Podolí, 147 00  
Czech Republic  
Tel: +420 241-410-928  
+420 241-403-095  
Fax: +420 241-409-435  
E-Mail: info@eiki.cz

## South East Asia

EIKI International Sdn Bhd  
No. 11, Nouvelle Industrial Park,  
Lorong Teknologi B, Taman Sains  
Selangor 1, Kota Damansara PJU5,  
47810 Petaling Jaya,  
Selangor Darul Ehsan, Malaysia  
Tel: +60 3-6157-9330  
Fax: +60 3-6157-1320  
E-Mail: sales@eiki.my

## Oceania

EIKI AUSTRALIA PTY LTD  
Level 5, 11 Queens Road,  
Melbourne, Victoria 3004, Australia  
Tel: +61 03-8530-7048  
Fax: +61 03-9820-5834  
E-Mail: sales@eiki.net.au

## Worldwide

EIKI International Sdn Bhd  
No. 11, Nouvelle Industrial Park,  
Lorong Teknologi B, Taman Sains  
Selangor 1, Kota Damansara PJU5,  
47810 Petaling Jaya,  
Selangor Darul Ehsan, Malaysia  
Tel: +60 3-6157-9330  
Fax: +60 3-6157-1320  
E-Mail: sales@eiki.my

World Wide Website <https://global.eiki.com>