

EPSON®

EH-LS650B/EH-LS650W User's Guide

Contents

EH-LS650B/EH-LS650W User's Guide	9
Introduction to Your Projector	10
Projector Features	10
Product Box Contents	11
Additional Components	11
Optional Equipment and Replacement Parts	12
Warranty and Registration Information (U.S. and Canada)	13
Warranty and Registration Information (Latin America)	13
Notations Used in the Documentation	14
Where to Go for Additional Information	14
Additional Projector Software and Manuals	14
Projector Part Locations	15
Projector Parts - Front/Top	16
Projector Parts - Top/Side	17
Projector Parts - Rear	18
Projector Parts - Base	19
Projector Parts - Remote Control	20
Setting Up the Projector	22
Projector Placement	22
Projector Setup and Installation Options	23
Projection Distance	24
Projector Connections	27
Connecting to an HDMI Video Source	28
Connecting to a USB Device	29
Connecting to an eARC/ARC Compatible AV System	30
Connecting to External Speakers	31
Connecting a Streaming Device	32
Connecting to a Bluetooth Audio Device	33
Installing Batteries in the Remote Control	34
Setting Up Android TV	35

Using Basic Projector Features	38
Turning On the Projector	38
Using the Home Screen.....	40
Turning Off the Projector	41
Focusing the Image.....	41
Adjusting the Front Feet	43
Image Shape.....	43
Correcting Image Distortion Using the Installation Menu	44
Adjusting Image Color when Projecting onto a Wall	45
Remote Control Operation	46
Using Voice Commands to Control Your Projector.....	47
Pairing the Remote Control	47
Selecting an Image Source	48
Using Your Projector as a Chromecast	48
Image Aspect Ratio	49
Changing the Image Aspect Ratio	49
Available Image Aspect Ratios	50
Color Mode.....	51
Changing the Color Mode.....	51
Available Color Modes.....	52
Turning On Automatic Luminance Adjustment	53
Adjusting Image Quality in Detail.....	54
Adjusting the Image Resolution.....	56
Using Frame Interpolation	57
Controlling the Volume with the Volume Buttons.....	58
Changing the Sound Mode.....	58
Adjusting Projector Features	60
Using the Projector as a Bluetooth Speaker.....	60
Operating Connected Devices Using the HDMI Link Features.....	61
Adjusting the Color Convergence (Panel Alignment)	62
Muting the Sound Temporarily	65
Shutting Off the Picture Temporarily	65
Changing the Projected Image Using Flexible Picture	65

Projector Security Features	67
Installing a Security Cable	67
Updating the Firmware	67
Resetting the Projector	68
Adjusting the Menu Settings	70
Using the Projector's Menus	70
Image Quality Settings - Picture Menu	71
Sound Quality Settings - Sound Menu	75
Projector Installation Settings - Installation Menu	78
Projector Feature Settings - Settings Menu	79
Projector Information Settings - Information Menu	81
Maintaining and Transporting the Projector	83
Projector Maintenance	83
Cleaning the Projection Window	83
Cleaning the Motion Sensor	85
Cleaning the Projector Case	85
Air Filter and Vent Maintenance	86
Cleaning the Air Filter and Vents	86
Replacing the Air Filter	89
Cleaning the Air Vents	91
Replacing the Remote Control Batteries	91
Transporting the Projector	93
Solving Problems	94
Projection Problem Tips	94
Projector Light Status	95
Solving Image or Sound Problems	96
Solutions When No Image Appears	97
Solutions When "No Signal" Message Appears	98
Displaying From a PC Laptop	99
Displaying From a Mac Laptop	99
Solutions When Only a Partial Image Appears	100
Solutions When the Image is Not Rectangular	100
Solutions When the Image Contains Noise or Static	100

Solutions When the Image is Flipped or Too Small	101
Solutions When the Image is Fuzzy or Blurry	101
Solutions When the Image Brightness or Colors are Incorrect	102
Solutions to Sound Problems	103
Solutions to Bluetooth Audio Problems	104
Solving Projector or Remote Control Operation Problems	104
Solutions to Projector Power or Shut-Off Problems	105
Solutions to Remote Control Problems.....	105
Solutions to HDMI Link Problems	106
Solving Network Problems	107
Solutions When Wireless Authentication Fails	107
Where to Get Help (U.S. and Canada)	107
Where to Get Help (Latin America).....	108
Technical Specifications	111
General Projector Specifications	111
Projector Light Source Specifications.....	113
Remote Control Specifications	113
Projector Dimension Specifications.....	113
Projector Electrical Specifications	116
Bluetooth Specifications	117
Projector Environmental Specifications.....	117
Projector Safety and Approvals Specifications.....	118
Supported Video Display Formats.....	118
Notices	121
Recycling (U.S. and Canada).....	121
Important Safety Information	121
Laser Safety Information	121
Important Safety Instructions.....	125
Restriction of Use	129
List of Safety Symbols.....	129
FCC Compliance Statement.....	133
Binding Arbitration and Class Waiver	134
Trademarks	137

Copyright Notice.....	138
A Note Concerning Responsible Use of Copyrighted Materials.....	139
Copyright Attribution	139

EH-LS650B/EH-LS650W User's Guide

Welcome to the EH-LS650B/EH-LS650W *User's Guide*.

For a printable PDF copy of this guide, [click here](#).

Note: Availability of products in this guide varies by country.

Introduction to Your Projector

Refer to these sections to learn more about your projector and this manual.

[Projector Features](#)

[Notations Used in the Documentation](#)

[Where to Go for Additional Information](#)

[Additional Projector Software and Manuals](#)

[Projector Part Locations](#)

Projector Features

The EH-LS650B/EH-LS650W projector includes these special features:

Bright, high-resolution projection system

- Up to 3600 lumens of color brightness (color light output) and white brightness (white light output)

Note: Color brightness (color light output) and white brightness (white light output) will vary depending on usage conditions. Color light output measured in accordance with IDMS 15.4; white light output measured in accordance with ISO 21118.

Flexible connectivity

- Two HDMI ports for computer or video device connection
- Stream content from your compatible device via Chromecast built-in

Innovative display and operation features

- Long-life laser light source
- Built-in Android TV
- Motion sensor near the projection window reduces light output to help prevent dangerous light exposure to the eyes
- Over 2,500,000:1 contrast ratio and Dynamic Contrast control for sharp, detailed images
- Powerful 2.1 channel Yamaha stereo speaker system with optical audio out port for connecting external speakers
- Bluetooth speaker mode

[Product Box Contents](#)

[Additional Components](#)

[Optional Equipment and Replacement Parts](#)

[Warranty and Registration Information \(U.S. and Canada\)](#)

[Warranty and Registration Information \(Latin America\)](#)

Parent topic: [Introduction to Your Projector](#)

Product Box Contents

Save all the packaging in case you need to ship the projector. Always use the original packaging (or equivalent) when shipping.

Make sure your projector box included all of these parts:

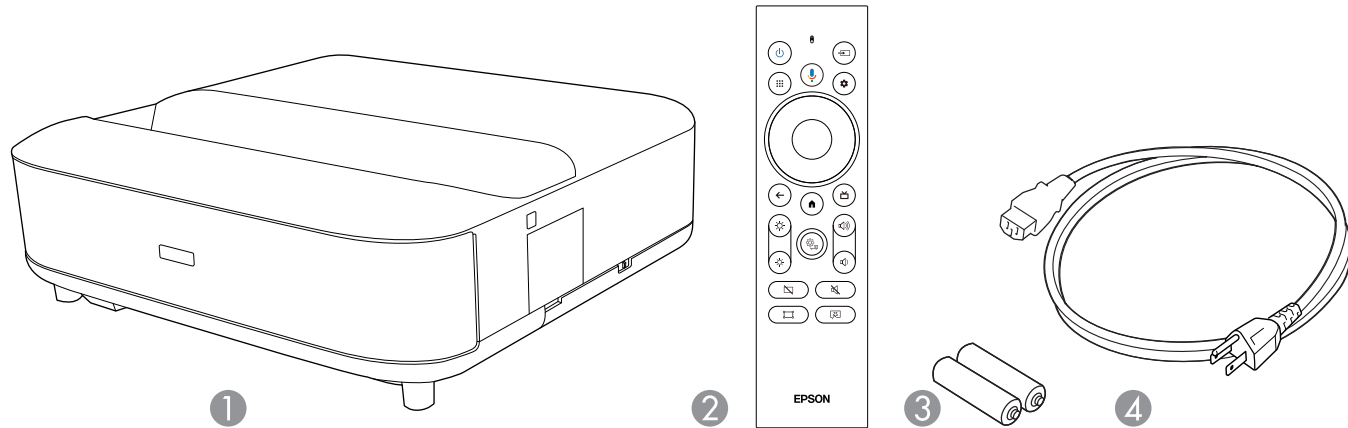

- 1 Projector
- 2 Remote control
- 3 Remote control batteries (2 AAA alkaline)
- 4 Power cord

Parent topic: [Projector Features](#)

Additional Components

Depending on how you plan to use the projector, you may need to obtain additional components.

Note: To connect a source that does not include a compatible video output port, you need to obtain an adapter that allows you to connect to an input port on the projector. If the device is a Mac, contact Apple for compatible adapter options. To connect a smartphone or tablet, you may need to obtain an adapter that allows you to connect to the projector. This allows you to mirror your smartphone or tablet screens, watch movies, and more. Contact your device manufacturer for compatible adapter options.

Unless listed as available from Epson in this table, see your local computer or electronics dealer for purchase information.

Note: Availability of accessories varies by country.

Signal or connection type	Additional component necessary
HDMI	Compatible HDMI cable U.S. and Canada: Available for purchase from Epson or an authorized Epson reseller. Latin America: Available for purchase from an authorized Epson reseller. Note: Older Mac computers (2009 and earlier) may not support HDMI audio.
Optical digital audio cable	Commercially available optical digital audio cable compatible with your device

Parent topic: [Projector Features](#)

Optional Equipment and Replacement Parts

U.S. and Canada: You can purchase screens, other optional accessories, and replacement parts from an Epson authorized reseller. To find the nearest reseller, call 800-GO-EPSON (800-463-7766) in the U.S. or 800-807-7766 in Canada. Or you can purchase online at epsonstore.com (U.S. sales) or epsonstore.ca (Canadian sales).

Latin America: You can purchase optional accessories and replacement parts from an Epson authorized reseller. To find the nearest reseller, go to latin.epson.com. Or you can click the "Where to Get Help" link below to contact your nearest sales office.

Note: Availability of accessories varies by country.

Epson offers the following optional accessories and replacement parts for your projector:

U.S. and Canada:

Option or part	Part number
Replacement air filter (ELPAF60)	V13H134A60
Ultra Short Throw Screen 100" (ELPSC35)	V12H002AL0
Ultra Short Throw Screen 120" (ELPSC36)	V12H002AM0

In addition to the accessories listed above, extended service plans are available.

Latin America:

Option or part	Part number
Replacement air filter (ELPAF60)	V13H134A60

Parent topic: [Projector Features](#)

Related references

[Where to Get Help \(U.S. and Canada\)](#)

[Where to Get Help \(Latin America\)](#)

Warranty and Registration Information (U.S. and Canada)

Your projector comes with a basic warranty that lets you project with confidence. For details, see the warranty that came with your projector.

Note: Availability varies by region.

Register your product online at this site: epson.com/webreg

Registering also lets you receive special updates on new accessories, products, and services.

Parent topic: [Projector Features](#)

Warranty and Registration Information (Latin America)

Your projector comes with a basic warranty that lets you project with confidence. For details, see the warranty that came with your projector.

Register your product online at latin.epson.com/registro

Registering also lets you receive special updates on new accessories, products, and services.

Parent topic: [Projector Features](#)

Notations Used in the Documentation

Follow the guidelines in these notations as you read your documentation:

- **Warnings** must be followed carefully to avoid bodily injury.
- **Cautions** must be observed to avoid damage to your equipment.
- **Notes** contain important information about your projector.
- **Tips** contain additional projection information.

Parent topic: [Introduction to Your Projector](#)

Where to Go for Additional Information

Need quick help on using your projector? Here's where to look for help:

- <https://support.google.com/androidtv/> for Android TV support
- [epson.com/support](https://www.epson.com/support) (U.S.), [epson.ca/support](https://www.epson.ca/support) (Canada), or [latin.epson.com/support](https://www.latin.epson.com/support) (Latin America)

View FAQs (frequently asked questions) and e-mail your questions to Epson technical support 24 hours a day.

- If you still need help after checking this manual and any other sources listed here, you can use the Epson PrivateLine Support service to get help fast (U.S. and Canada only). For details, see "Where to Get Help."

Parent topic: [Introduction to Your Projector](#)

Related references

[Where to Get Help \(U.S. and Canada\)](#)

[Where to Get Help \(Latin America\)](#)

Additional Projector Software and Manuals

After connecting and setting up the projector, install the projector software as necessary. You may need to install it from a software CD, if included, or download the software and manuals as necessary.

You can install the projector software programs listed here and view their manuals for instructions on using them.

Note: If you still need help after checking this manual and the sources listed here, you can use the Epson PrivateLine Support service to get help fast (U.S. and Canada only). For details, see "Where to Get Help."

Projector software	Manual	Description
—	<i>Open Source Software License</i>	You can download this document from the Epson web site. Go to epson.com/support (U.S.), epson.ca/support (Canada), or latin.epson.com/support (Latin America) and select your projector.
Epson Setting Assistant app	Instructions are included with the app	Lets you use the camera on your iOS or Android device to automatically adjust the shape of your projected image if there is any distortion. The device and your projector must be connected to the same network. You can download the latest software and documentation from the Apple App Store or Google Play Store.

Parent topic: [Introduction to Your Projector](#)

Related references

[Where to Get Help \(U.S. and Canada\)](#)

[Where to Get Help \(Latin America\)](#)

Projector Part Locations

Check the projector part illustrations to learn about the parts on your projector.

[Projector Parts - Front/Top](#)

[Projector Parts - Top/Side](#)

[Projector Parts - Rear](#)

[Projector Parts - Base](#)

[Projector Parts - Remote Control](#)

Parent topic: [Introduction to Your Projector](#)

Projector Parts - Front/Top

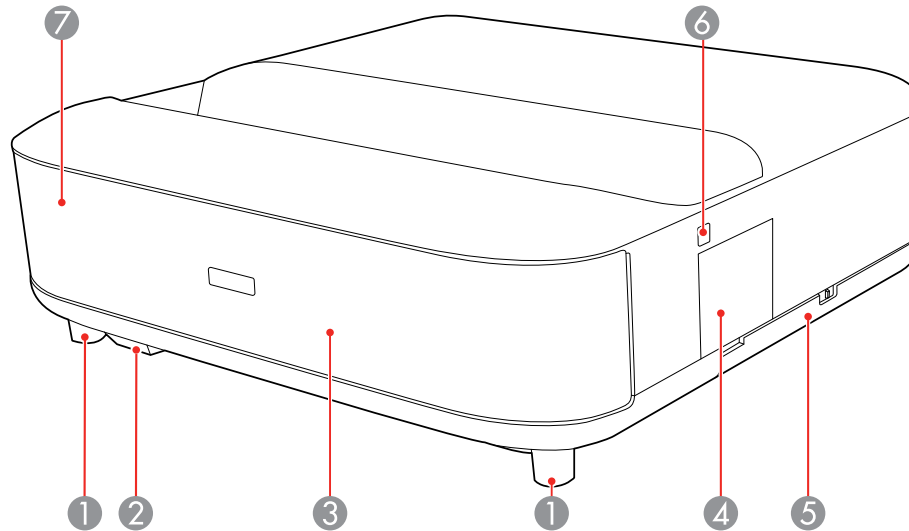

- 1 Front adjustable feet (turn the feet to adjust the horizontal tilt)
- 2 Remote receiver (receives signals from the remote control)
- 3 Speaker (outputs audio)
- 4 Focus lever cover (open to access the focus lever)
- 5 Air filter cover (open to access the air filter)
- 6 Power button (turns the projector on or off)
- 7 Status light (indicates the projector's status)

Parent topic: [Projector Part Locations](#)

Related references

[Projector Light Status](#)

Projector Parts - Top/Side

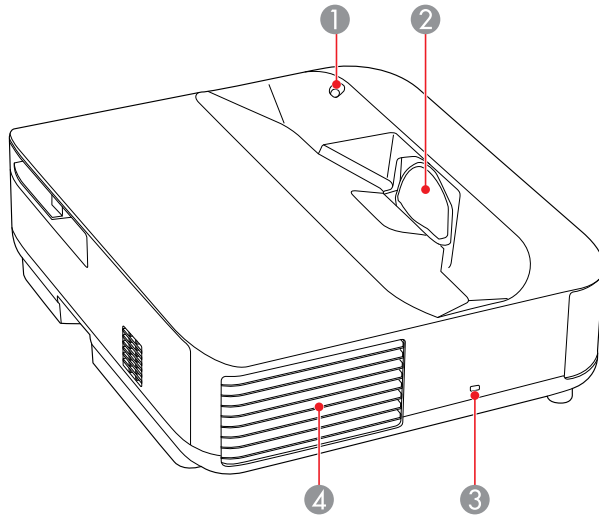

- 1 Motion sensor (detects movement near the projection window and reduces the brightness of the light source for safety)

Note: The detection range may vary depending on the temperature in the surrounding environment. Movement may not be detectable through glass or other transparent materials.

- 2 Projection window (images are projected from the lens inside the projector)
- 3 Kensington security slot
- 4 Air exhaust vent (cools the projector internally)

Parent topic: [Projector Part Locations](#)

Related references

[Projector Light Status](#)

Projector Parts - Rear

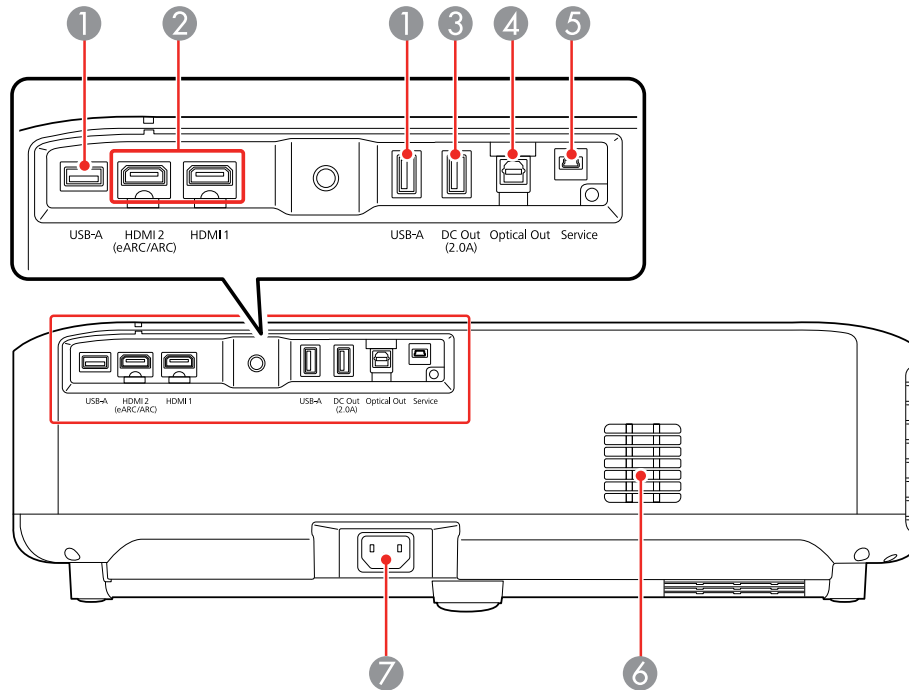

- 1 **USB-A** port (for connecting an external USB device (such as a webcam, external HDD, or keyboard) or an RJ45 adapter to enable wired LAN connections)
- 2 **HDMI1/HDMI2 (eARC/ARC)** ports (inputs video signals from HDMI compatible video equipment and computers)

Note: This product is compatible with HDCP 2.3. The HDMI2 port is compatible with HDMI eARC and ARC.

- 3 **DC Out (2.0A)** port (for connecting an optional streaming media player; USB data transfer is not available)
- 4 **Optical Out** port (outputs audio from the current input source to an external audio device)
- 5 **Service** port (for service technicians only; do not use)
- 6 **Air intake vent** (takes in air to cool the projector internally)

7 Power inlet (connects the power cord to the projector)

Parent topic: [Projector Part Locations](#)

Related concepts

[Projector Connections](#)

Projector Parts - Base

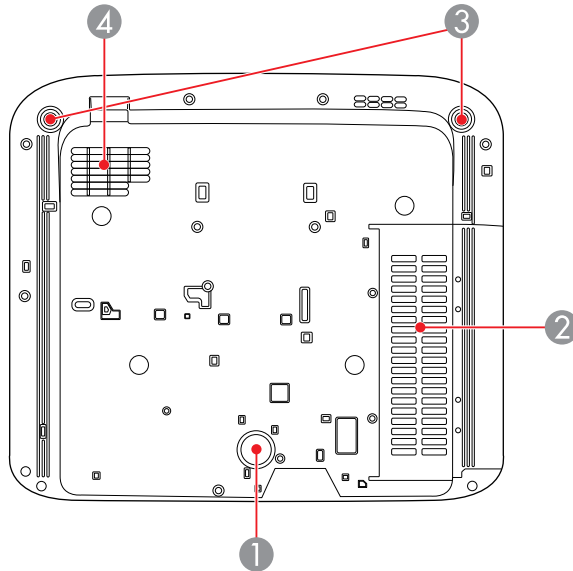

- 1 Rear foot (provides stability when projecting on a flat surface)
- 2 Air intake vent (air filter) (takes in air to cool the projector internally)
- 3 Front adjustable feet (turn the feet to adjust the horizontal tilt)
- 4 Air intake vent (takes in air to cool the projector internally)









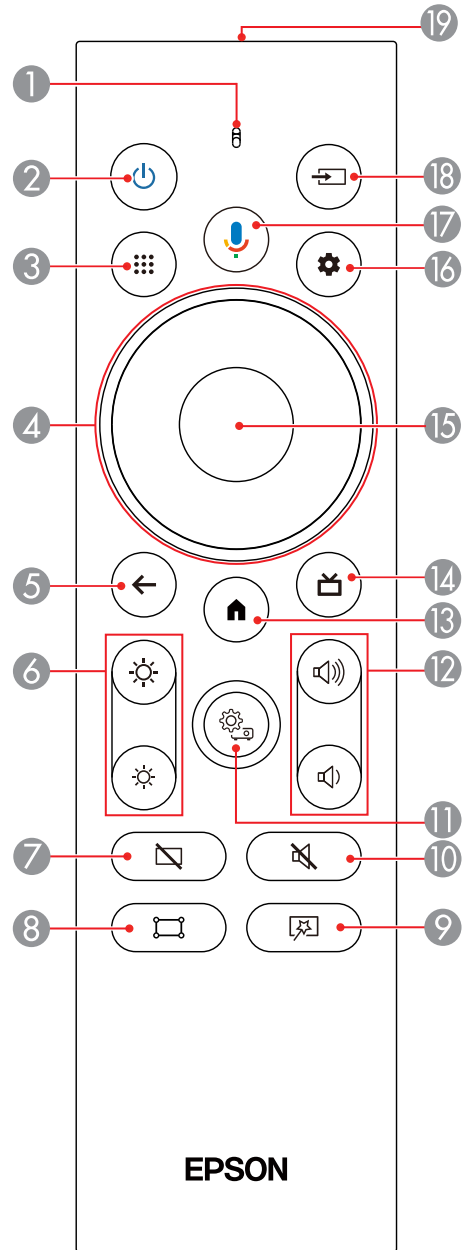





Parent topic: [Projector Part Locations](#)

Related references

[Projector Dimension Specifications](#)

Projector Parts - Remote Control



- 1 Microphone (listens for voice commands after pressing the  mic button)
- 2  power button
- 3  apps button (displays available Android TV apps)
- 4 Directional pad (move through on-screen options)
- 5  esc button (cancels/exits function)
- 6 Brightness up and brightness down buttons
- 7  blank button (turns off picture)
- 8  Corner Adjustment button (displays the Corner Adjustment screen to adjust the image shape)
- 9  Flexible Picture menu button (opens Flexible Picture menu)
- 10  mute button (turns off sound)
- 11  settings button (accesses projector menus)
- 12 Volume up and volume down buttons
- 13  home button (accesses Android TV Home screen)
- 14  live guide button (displays the library of movies)
- 15 **Enter** button (selects options)
- 16  Android TV settings button (accesses Android TV menus)
- 17  button (operates Android TV using voice commands)
- 18  Source Search button (changes the input source)
- 19 Remote control emitter

Parent topic: [Projector Part Locations](#)

Setting Up the Projector

Follow the instructions in these sections to set up your projector for use.

[Projector Placement](#)

[Projector Connections](#)

[Installing Batteries in the Remote Control](#)

[Setting Up Android TV](#)

Projector Placement

You can place the projector on almost any flat surface to project an image.

Warning: The projector is not intended to be ceiling- or wall-mounted. Do not mount the projector on a ceiling or a wall. It could fall and cause damage or injury.

Keep these considerations in mind as you select a projector location:

- Place the projector on a sturdy, level surface.
- Do not install the projector on an unstable surface or in a location beyond the weight specifications of the projector. Otherwise, it could fall or topple causing an accident and injury.
- Do not place or install the projector vertically.
- Do not tilt the projector right or left or project images straight up or straight down. If the image is tilted, rotate the front feet to adjust their height.
- Leave plenty of space around and under the projector for ventilation, and do not place it on top of or next to anything that could block the vents.
- Wherever you set up the projector, make sure to position it squarely in front of the center of the screen, not at an angle, if possible. If you cannot install the projector squarely facing the screen, correct any resulting keystone distortion using the  Corner Adjustment button on the remote control. For the best quality images, we recommend adjusting the installation position of the projector to achieve the correct image size and shape.
- Position the projector within reach of a grounded electrical outlet or extension cord.
- Try not to set up the projector in locations subject to high humidity and dust, or in locations subject to smoke or steam. Otherwise, it could cause a fire or electric shock to occur.

- If you are using the projector at altitudes above 4921 feet (1500 m), set the **High Altitude Mode** setting to **On** in the projector's Settings menu to ensure the projector's internal temperature is regulated properly.

[Projector Setup and Installation Options](#)

[Projection Distance](#)

Parent topic: [Setting Up the Projector](#)

Projector Setup and Installation Options

You can set up or install your projector in the following ways:

Front

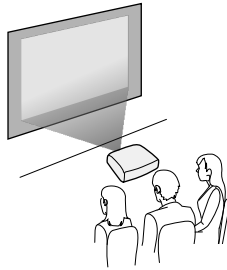

Wherever you set up the projector, make sure to position it squarely in front of the center of the screen, not at an angle, if possible. If you cannot install the projector squarely facing the screen, correct any resulting keystone distortion using the  Corner Adjustment button on the remote control. For the best quality images, we recommend adjusting the installation position of the projector to achieve the correct image size and shape. Do not place or install the projector vertically.

Note: The projector is not intended to be ceiling- or wall-mounted. Do not mount the projector on a ceiling or a wall. It could fall and cause damage or injury.

Installation space

Be sure to leave the following amount of space around the projector so as to not block the air exhaust or intake vents.

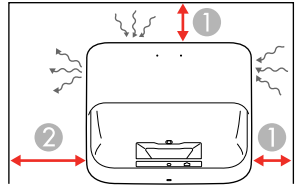

1 3.9 inches (10 cm)

2 12 inches (30 cm)

Parent topic: [Projector Placement](#)

Projection Distance

The distance at which you place the projector from the screen determines the approximate size of the image. The image size increases the farther the projector is from the screen, but can vary depending on the zoom factor, aspect ratio, and other settings.

Use the tables here to determine approximately how far to place the projector from the screen based on the size of the projected image. (Conversion figures may have been rounded up or down.)

You can also use the Projection Distance Calculator [here](#) (U.S.), [here](#) (Canada), or [here](#) (Caribbean).

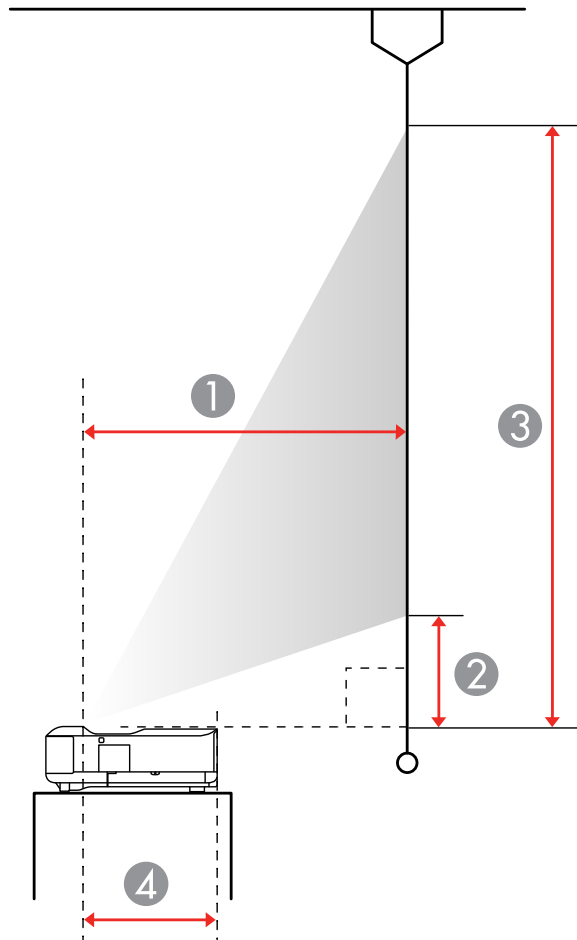

- 1 Projection distance (from image to rear of projector)
- 2 Distance from projector to the bottom of the screen
- 3 Distance from projector to the top of the screen

4 12.13 inches (30.83 cm) (distance from the center of the lens to the rear of the projector)

Note: The distance from the table surface to the top of the projector is 6.22 inches (15.8 cm).

16:9 Aspect Ratio Image or Screen			
Screen or image size	Projection distance (1)	Offset from top of projector (2)	Offset from top of projector (3)
60 inches (152.4 cm)	12.79 inches (32.5 cm)	4.5 inches (11.5 cm)	33.9 inches (86.3 cm)
65 inches (165.1 cm)	14.01 inches (35.6 cm)	5.1 inches (13 cm)	37 inches (94 cm)
70 inches (177.8 cm)	15.27 inches (38.8 cm)	5.7 inches (14.5 cm)	40.4 inches (101.7 cm)
75 inches (190.5 cm)	16.53 inches (42 cm)	6.3 inches (16 cm)	43.0 inches (109.4 cm)
80 inches (203.2 cm)	17.7 inches (45.1 cm)	6.8 inches (17.5 cm)	46.1 inches (117.1 cm)
90 inches (228.6 cm)	20.2 inches (51.4 cm)	8.1 inches (20.5 cm)	52.1 inches (132.5 cm)
100 inches (254 cm)	22.7 inches (57.7 cm)	9.2 inches (23.5 cm)	58.2 inches (148 cm)
120 inches (304.8 cm)	27.6 inches (70.3 cm)	11.5 inches (29.4 cm)	70.4 inches (178.8 cm)

4:3 Aspect Ratio Image or Screen			
Screen or image size	Projection distance (1)	Offset from top of projector (2)	Offset from top of projector (3)
50 inches (127 cm)	13 inches (33.2 cm)	4.6 inches (11.9 cm)	34.6 inches (88.1 cm)
55 inches (139.7 cm)	14.6 inches (37.1 cm)	5.3 inches (13.7 cm)	38.3 inches (97.5 cm)
60 inches (152.4 cm)	16.1 inches (41 cm)	6.1 inches (15.5 cm)	42.1 inches (107 cm)
65 inches (165.1 cm)	17.6 inches (44.8 cm)	6.8 inches (17.4 cm)	45.8 inches (116.4 cm)
70 inches (177.8 cm)	19.1 inches (48.7 cm)	7.5 inches (19.2 cm)	49.5 inches (125.9 cm)
75 inches (190.5 cm)	20.6 inches (52.5 cm)	8.2 inches (21 cm)	53.2 inches (135.3 cm)
80 inches (203.2 cm)	22.2 inches (56.4 cm)	8.9 inches (22.8 cm)	56.9 inches (144.7 cm)
98 inches (248.9 cm)	27.6 inches (70.3 cm)	11.5 inches (29.4 cm)	70.3 inches (178.7 cm)

16:10 Aspect Ratio Image or Screen			
Screen or image size	Projection distance (1)	Offset from top of projector (2)	Offset from top of projector (3)
56 inches (142.2 cm)	12.9 inches (32.8 cm)	4.6 inches (11.7 cm)	34.3 inches (87.1 cm)
60 inches (152.4 cm)	14 inches (35.6 cm)	5.1 inches (13 cm)	36.9 inches (93.8 cm)
65 inches (165.1 cm)	15.3 inches (39 cm)	5.7 inches (14.6 cm)	40.2 inches (102.1 cm)
70 inches (177.8 cm)	16.7 inches (42.4 cm)	6.3 inches (16.2 cm)	43.4 inches (110.4 cm)
80 inches (203.2 cm)	19.3 inches (49.2 cm)	7.6 inches (19.4 cm)	50.3 inches (127.1 cm)
90 inches (228.6 cm)	22 inches (56 cm)	8.9 inches (22.6 cm)	56.6 inches (143.8 cm)
100 inches (254 cm)	24.7 inches (62.8 cm)	10.1 inches (25.9 cm)	63.1 inches (160.5 cm)
111 inches (281.9 cm)	27.7 inches (70.3 cm)	11.5 inches (29.4 cm)	70.3 inches (178.8 cm)

Parent topic: [Projector Placement](#)

Projector Connections

See these sections to connect the projector to a variety of projection sources.

Caution: If you will use the projector at altitudes above 4921 feet (1500 m), turn on **High Altitude Mode** to ensure the projector's internal temperature is regulated properly. See the menu link below.

Caution: Check the shape and orientation of the connectors on any cable you plan to connect. Do not force a connector into a port if it does not fit. The device or your projector could be damaged or could malfunction.

[Connecting to an HDMI Video Source](#)

[Connecting to a USB Device](#)

[Connecting to an eARC/ARC Compatible AV System](#)

[Connecting to External Speakers](#)

[Connecting a Streaming Device](#)

[Connecting to a Bluetooth Audio Device](#)

Parent topic: [Setting Up the Projector](#)

Related references

[Additional Components](#)

[Projector Feature Settings - Settings Menu](#)

Connecting to an HDMI Video Source

If your video source has an HDMI port, you can connect it to the projector using an optional HDMI cable.

Caution: Do not turn on the video source before connecting it to the projector. Doing so could damage the projector.

Note: If the port on your device has an unusual shape, use the cable supplied with the device or an optional cable to connect to the projector. Some video equipment is capable of outputting different types of signals. See your video equipment manual to confirm what type of signals can be output.

1. Connect the HDMI cable to your video source's HDMI output port.

Note: To display signals in the 18 Gbps transmission band, such as from a 4K 60 fps source, use a cable rated for HDMI 2.0 or higher or you may have trouble displaying an image.

2. Connect the other end to one of the HDMI ports on the rear of the projector.

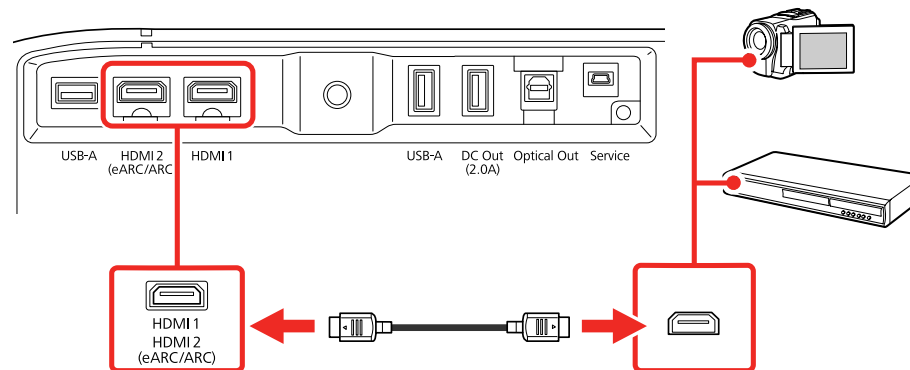

Note: When an audio/video source that meets the HDMI CEC standard is connected to one of the projector's HDMI ports, you can use the projector's remote control to control certain features of the linked device by accessing the Settings menu and enabling the **HDMI CEC** setting.

Parent topic: [Projector Connections](#)

Related references

[Projector Feature Settings - Settings Menu](#)

Connecting to a USB Device

You can connect a USB device or cable to the projector's USB-A port to project images from the device. Use the USB cable supplied with the device.

You may need to use an app that supports your file type on the projector to project the content from your USB device. See your device's documentation for details.

Note: Do not connect a USB hub or a USB cable longer than 9.8 feet (3 m), or the device may not operate correctly. The USB-A port is not guaranteed to operate all devices that support USB.

Make sure the USB device meets the following requirements:

- The device must be a USB flash drive, USB hard drive, or a digital camera or microphone
 - USB hard drives must be USB Mass Storage Class compliant (not all compliant devices are supported); formatted in FAT16/32; self-powered by their own AC power supplies (bus powered drives are not recommended); and should not have multiple partitions.
1. If your USB device came with an AC adapter, plug the device into an electrical outlet.
 2. Connect the USB device or cable to the projector's **USB-A** port.

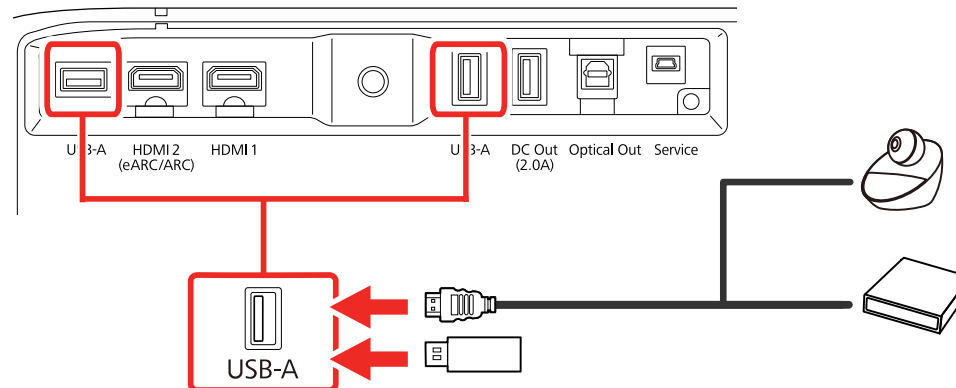

3. If you connected a USB cable, connect the other end to the USB device as necessary.

The projector displays images stored on the USB device.

Parent topic: [Projector Connections](#)

Connecting to an eARC/ARC Compatible AV System

If your external speakers or A/V receiver are HDMI ARC-compatible, you can connect them to the projector's **HDMI2 (eARC/ARC)** port using an optional HDMI cable. Make sure the **HDMI CEC** setting is enabled and then enable **HDMI2 ARC**. In the projector's Sound menu, set **Sound Output Device** as **ARC** or **eARC**. Connecting this way bypasses the projector's speakers and enables you to adjust the speaker's volume with the projector's remote control.

Note: If you want to output higher quality audio, set **Sound Output Format** as **Auto** in the projector's Sound menu.

Note: Connecting to an eARC compatible system requires a high-speed HDMI 2.0 (with Ethernet) cable or better. The audio format is determined by the specifications of the connected AV system or external audio device such as a soundbar.

1. Connect the HDMI cable to the eARC/ARC-compatible HDMI port on your external speakers or A/V receiver.

Note: To display signals in the 18 Gbps transmission band, such as from a 4K 60 fps source, use a cable rated for HDMI 2.0 or higher or you may have trouble displaying an image.

2. Connect the other end to the **HDMI2 (eARC/ARC)** port on the rear of the projector.

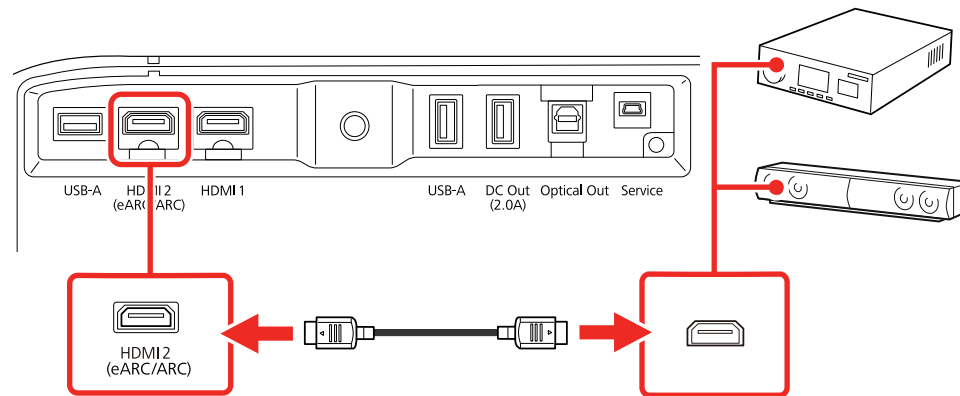

3. Select any HDMI control settings on the connected speakers or receiver, as necessary. See your device's documentation for more information.

eARC/ARC Supported Audio Format

- LPCM: 2ch (Max 48kHz/24bit)
- Dolby Digital (AC-3)
- Dolby Digital Plus
- Dolby Atmos (eARC only)
- DTS

Parent topic: [Projector Connections](#)

Related references

[Projector Feature Settings - Settings Menu](#)

[Sound Quality Settings - Sound Menu](#)

Connecting to External Speakers

To enhance the sound from your video source, you can connect the projector to external self-powered speakers using the optical digital audio out port.

You can also connect the projector to an amplifier with speakers.

Note: When using digital audio out, both the internal speakers and the external audio device will output sound. In this case, it is recommended that you mute or completely lower the volume on the projector's internal speakers to avoid interference.

Note: If you want to output higher quality audio, set **Sound Output Format** to **Auto** in the projector's Sound menu.

1. Make sure your computer or video source is connected to the projector via HDMI, if necessary.
2. Locate an optical digital audio cable to connect your external speakers, or another type of cable with the appropriate adapter.
3. Connect one end of the cable to your external speakers as necessary.

4. Connect the optical digital audio connector end of the cable to your projector's **Optical Out** port.

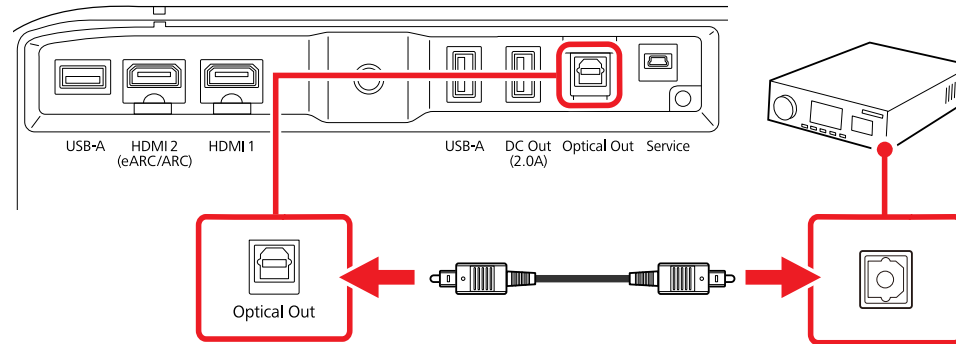

Note: Digital audio out volume levels cannot be controlled with the projector remote. To adjust the volume levels, use the volume controls on the external audio device instead.

Parent topic: [Projector Connections](#)

Connecting a Streaming Device

You can connect a streaming device to the projector's **HDMI** port. Connecting the USB power cable provides power to the streaming device.

1. Connect the streaming device to the projector's HDMI port.

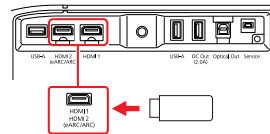

2. Connect the device's USB power cable to the projector's **DC Out (2.0A)** USB power port.

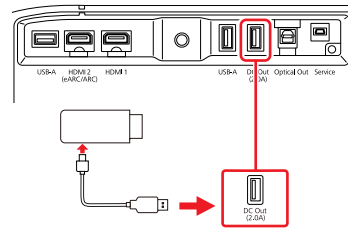

3. Connect the other end of the cable to the streaming media player.

Parent topic: [Projector Connections](#)

Connecting to a Bluetooth Audio Device

You can connect your projector to Bluetooth audio devices such as speakers or headphones to output audio.

Note: Make sure the Bluetooth Speaker mode is set to **Off**. If the projector is in Bluetooth Speaker mode, you cannot pair output devices such as headphones or external speakers.

Note: There may be a slight delay in audio output. Bluetooth audio devices are not supported in some countries and regions.

Note: When a Bluetooth audio device is paired to the projector, the built-in speaker system and the **Optical Out** port are disabled.

1. Turn on the projector.
2. Select the  Android TV settings icon at the top right of the Android TV Home screen and press **Enter**.
3. Select **Remotes & Accessories** and press **Enter**.

The projector searches for compatible Bluetooth devices.

4. Turn on your device and start the pairing process on it. See the documentation supplied with the device for more information.
Compatible devices are displayed on-screen when discovered by the projector. You cannot connect multiple devices by Bluetooth at the same time.
5. Select the device you want to connect to and press **Enter**.
6. Follow the on-screen instructions to complete pairing.

Note: If pairing is unsuccessful, make sure the Bluetooth Speaker mode is set to **Off**.

7. Press the ← esc button to exit the menus.

Parent topic: [Projector Connections](#)

Installing Batteries in the Remote Control

The remote control uses the two AAA batteries that came with the projector. Replace the batteries as soon as they run out.

Caution: Use only the type of batteries specified in this manual. Do not install batteries of different types, or mix new and old batteries.

1. Remove the battery cover.

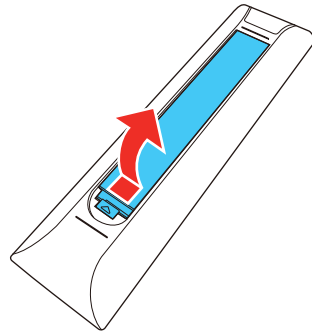

2. Insert the batteries with the + and – ends facing as shown.

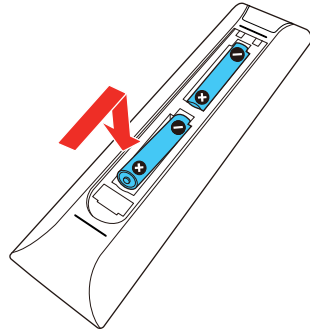

Warning: Make sure the batteries are inserted in the correct positions. If the batteries are not inserted correctly, they could explode or leak, causing a fire, injury, or damage to the product.

3. Replace the battery cover and press it down until it clicks into place.

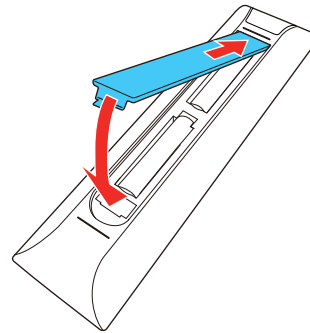



Warning: Dispose of used batteries according to local regulations. Do not expose batteries to heat or flame. Keep batteries out of the reach of children; they are choking hazards and are very dangerous if swallowed.

Parent topic: [Setting Up the Projector](#)

Setting Up Android TV

Android TV must be set up when you turn on the projector for the first time.

Note: A Google account is required to use certain features. Some apps require a paid subscription. After initial setup, you can change the settings by selecting the  Android TV settings icon at the top right of the Android TV Home screen.

1. Turn on the projector.
2. When the pairing screen is displayed, press and hold the **Enter** and  home remote control buttons at the same time for about 3 seconds.

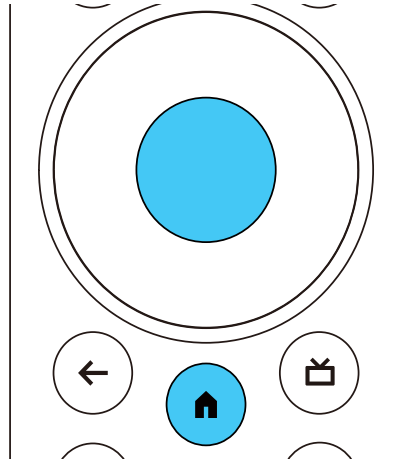

The light on the remote control flashes until pairing is complete.

3. Use the remote control directional pad and **Enter** button to select the language you want to use from the language selection screen.
4. Do one of the following:
 - Select **Continue** to use an Android phone to set up the projector's Wi-Fi and Google account settings. Follow the on-screen instructions and skip to step 7.
 - Select **Skip** to set up the projector's Wi-Fi and Google account settings manually. Go to the next step.
5. Select the wireless network you want to use from the Wi-Fi setting screen and then follow the on-screen instructions to make any necessary settings.
6. At the Google account sign-in screen, do one of the following:
 - Select **Sign In** to sign-in to your Google account. Follow the on-screen instructions.

- Select **Skip** to use the projector without signing in to a Google account.
7. Follow the on-screen instructions to proceed with initial setup, selecting settings as desired.
The Home screen is displayed when initial setup is completed.

Parent topic: [Setting Up the Projector](#)

Using Basic Projector Features

Follow the instructions in these sections to use your projector's basic features.

[Turning On the Projector](#)

[Turning Off the Projector](#)

[Focusing the Image](#)

[Adjusting the Front Feet](#)

[Image Shape](#)

[Adjusting Image Color when Projecting onto a Wall](#)

[Remote Control Operation](#)

[Using Voice Commands to Control Your Projector](#)

[Pairing the Remote Control](#)

[Selecting an Image Source](#)

[Using Your Projector as a Chromecast](#)

[Image Aspect Ratio](#)

[Color Mode](#)

[Adjusting Image Quality in Detail](#)

[Adjusting the Image Resolution](#)

[Using Frame Interpolation](#)

[Controlling the Volume with the Volume Buttons](#)

[Changing the Sound Mode](#)

Turning On the Projector

Turn on the projector before you turn on the computer or video equipment you want to use.

Note: If you will use the projector at altitudes above 4921 feet (1500 m), turn on **High Altitude Mode** to ensure the projector's internal temperature is regulated properly.

1. Connect the computer or video equipment you want to use to one of the projector's HDMI ports, if necessary.

2. Connect the power cord to the projector's power inlet.

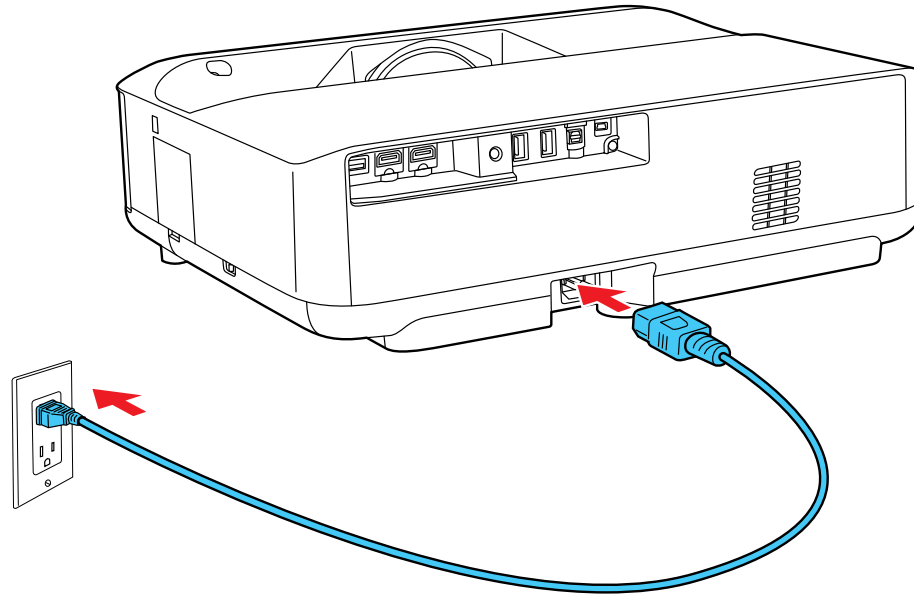

3. Plug the power cord into an electrical outlet.
The projector enters standby mode. This means the projector is receiving power, but has not yet been turned on.
4. Press the power button on the projector or remote control to turn on the projector.
The Status light flashes blue as the projector warms up. When the projector is warmed up, the Status light stops flashing and turns blue.

Warning: Never look into the projector lens when the laser is on. This can damage your eyes and is especially dangerous for children and pets. If you are using the remote control to turn the projector on, make sure no one is looking into the lens or in front of the projector before turning it on.

Caution: Make sure no objects are blocking the light from the projector lens. Objects blocking the lens for an extended time can melt, burn, or start a fire, and light that is reflected back into the lens can cause the projector to malfunction. To stop projection, turn off the projector.

Note: If this is the first time you are turning on the projector, you need to pair the remote control and complete initial setup. Follow any on-screen instructions to complete the settings. Make sure to point the front of the remote at the front of the projector when attempting to pair the remote.

Using the Home Screen

Parent topic: [Using Basic Projector Features](#)

Related references

[Projector Feature Settings - Settings Menu](#)

Using the Home Screen

You can easily access online content, applications, and projector settings from the Android TV home screen.

1. To display the Home screen, press the  home button on the remote control.
2. Use the directional pad on the remote control to navigate the screen, and press **Enter** to select an option.

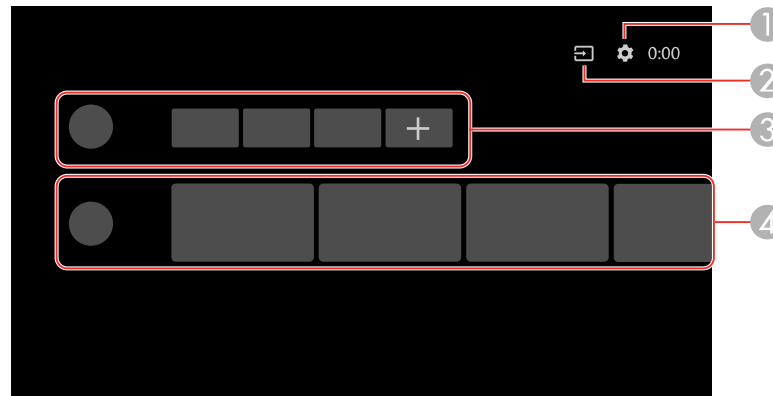

- 1 Displays the Settings menu for Android TV (you can select various settings such as Wi-Fi, language, and Google account information)
- 2 Displays a list of available input sources
- 3 Displays the applications downloaded to your Android TV (add applications to this list by selecting the + icon)

- 4 Displays recommended content from your applications

Note: The content of the Home screen may change depending on the Android TV version.

Parent topic: [Turning On the Projector](#)

Turning Off the Projector

Before turning off the projector, shut down any computer connected to it so you can see the computer display during shutdown.

Note: Turn off this product when not in use to prolong the life of the projector. Laser life will vary depending upon mode selected, environmental conditions, and usage. Brightness decreases over time.

1. Press and hold the power button on the projector or remote control.
2. Select **Power Off** on the displayed screen.

The laser turns off and the Status light turns off.

Note: A short press of the power button puts the projector into suspended mode, and it will continue to operate under minimal power even if the power is turned off. This lets the projector start quickly the next time you turn it on.

3. To transport or store the projector, make sure the Status light is off, then unplug the power cord.

Parent topic: [Using Basic Projector Features](#)

Related references

[Projector Feature Settings - Settings Menu](#)

Focusing the Image

1. Turn on the projector and display an image.

2. Open the focus lever cover.

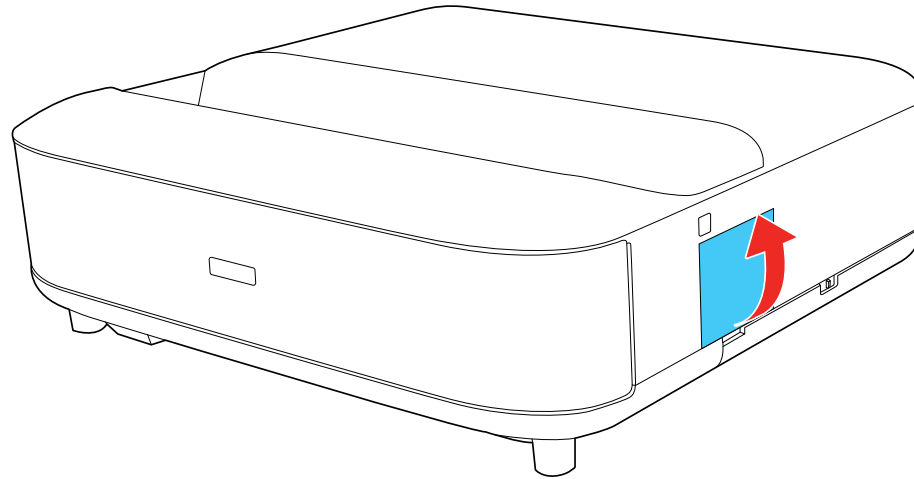

3. Raise or lower the focus lever to sharpen the image.

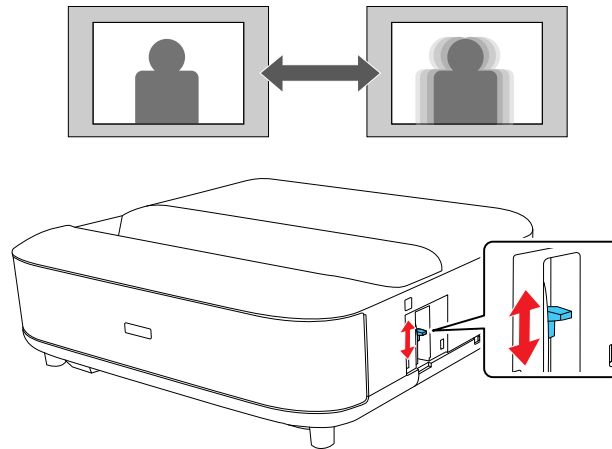

4. Close the focus lever cover.

Parent topic: [Using Basic Projector Features](#)

Adjusting the Front Feet

If you are projecting from a table or other flat surface, you can adjust the image using the projector's adjustable feet. To adjust the image height, set the projector higher or lower while keeping it level and parallel to the screen.

1. Turn on the projector and display an image.
2. Rotate the front feet to adjust any tilting or vertical distortion.

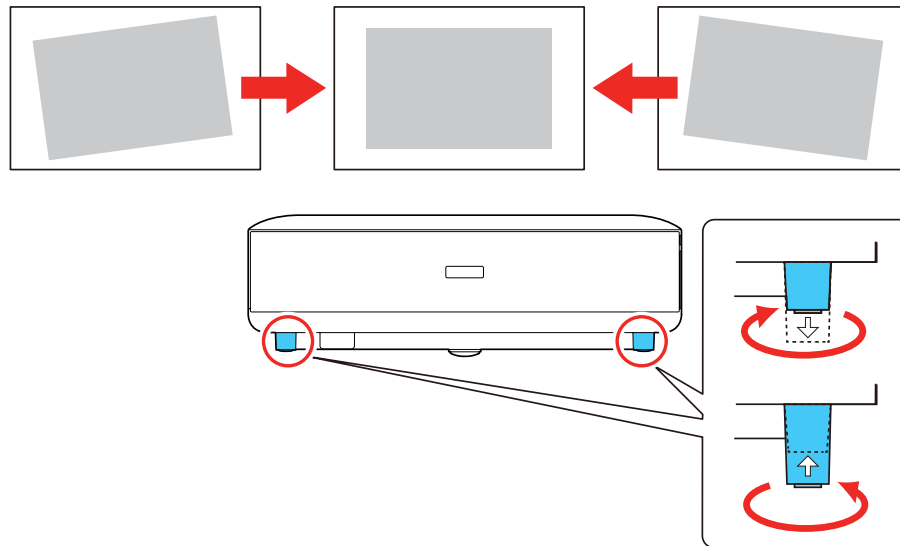

If the projected image is unevenly rectangular, you need to adjust the image shape.

Parent topic: [Using Basic Projector Features](#)

Image Shape

You can project an evenly rectangular image by placing the projector directly in front of the center of the screen and keeping it level. If you place the projector at an angle to the screen, or tilted up or down, or off to the side, you may need to correct the image shape for the best display quality. After correction, your image is slightly smaller.

To correct distortion more easily, you can use the Epson Setting Assistant app on a smartphone or tablet that has a camera function. You can download it from the Apple App Store or Google Play Store. Install the application by using the QR code displayed on the projected screen.

[Correcting Image Distortion Using the Installation Menu](#)

Parent topic: [Using Basic Projector Features](#)

Correcting Image Distortion Using the Installation Menu

You can correct distortion when the projected image shape is curved or not rectangular by following the on-screen instructions from the projector's Installation menu.

You can also correct image distortion using the Epson Setting Assistant app on an iOS or Android device with a camera. You can scan the QR code on the Installation menu or download the latest version of the app from the Apple App Store or Google Play. Follow the instructions in the app.

Note: After correction, your image is slightly smaller.

1. Turn on the projector and display an image.
2. Press the  Corner Adjustment button on the remote control.
3. Use the focus lever and the reference marks on the upper corners of the image to adjust the focus.

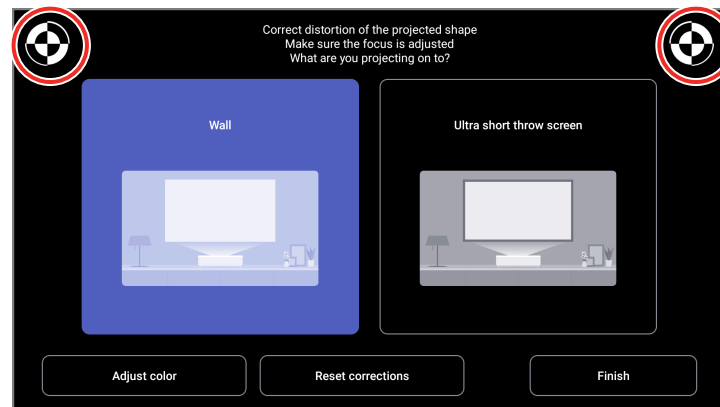

4. Use the remote control to select the option that best suits the surface you are projecting onto and follow the on-screen instructions to correct distortion in the image.
5. When you are finished, press the  esc button on the remote control to exit the menus.

Parent topic: [Image Shape](#)

Adjusting Image Color when Projecting onto a Wall

When projecting onto a wall, you can use the preset color correction to compensate for the color of the wall.

You can make other detailed color adjustments in the projector's Picture menu.

1. Turn on the projector and display an image.
2. Press the  Corner Adjustment button on the remote control.

You see a screen like this:

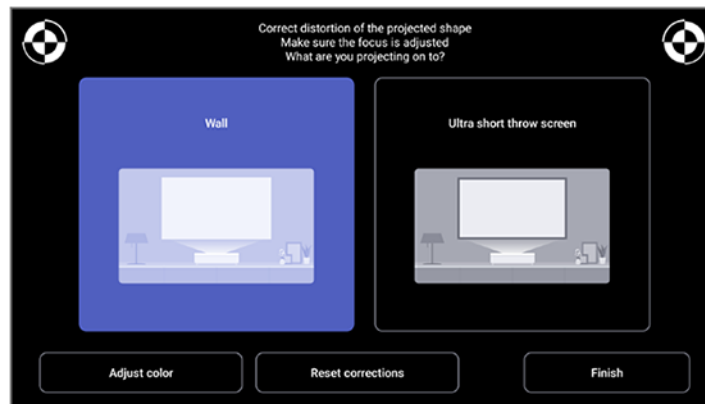

3. Select **Adjust color** and press **Enter**.

You see a screen like this:

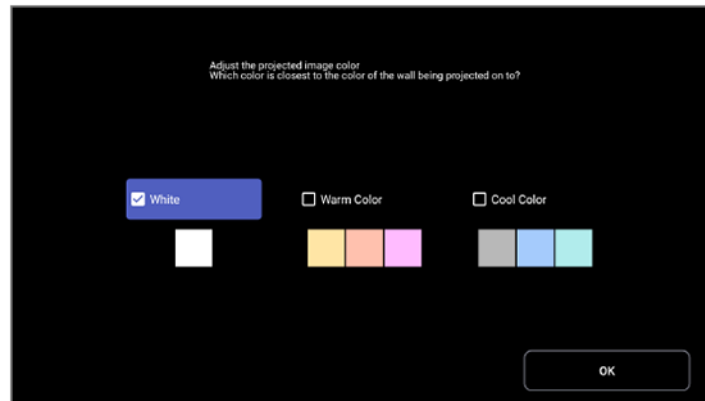

4. Select the color that is closest to the color of the wall and select **OK**.

Parent topic: [Using Basic Projector Features](#)

Remote Control Operation

The remote control lets you control the projector from almost anywhere in the room, up to 19.7 feet (6 m) away.

Make sure that you aim the remote control at the projector's receiver within the angles listed here.

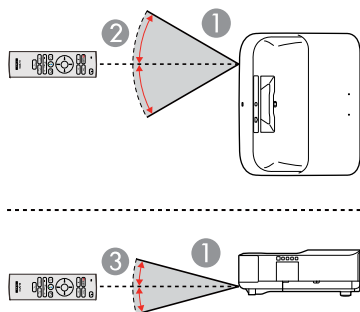

1 19.7 feet (6 m)

2 ± 30°

3 ± 15°

Note: Avoid using the remote control in conditions with bright fluorescent lights or in direct sunlight, or the projector may not respond to commands. If you will not use the remote control for a long time, remove the batteries.

Parent topic: [Using Basic Projector Features](#)

Using Voice Commands to Control Your Projector

You can use your remote control or linked Google Home device to control your projector using voice commands.

Note: Make sure the remote control is paired to the projector.

1. To use voice commands with your projector using your remote, press and release the  button, then say the command you want to perform.

You can use voice commands to search for actors or shows, open installed apps, and control media playback.

2. To use a Google Home device to send voice commands to your projector, link the device with your projector using the Google Home app. You may also need to link streaming apps to your Google account. For detailed instructions, go to your device's support page.

Parent topic: [Using Basic Projector Features](#)

Related tasks

[Pairing the Remote Control](#)

Pairing the Remote Control

To use Android TV and video-on-demand features, you must pair the remote control to the projector.

Note: When you first turn on the projector, instructions for pairing the remote control are displayed on the screen.



1. Turn on the projector.
2. When the pairing screen is displayed, press and hold the  home and **Enter** buttons on the remote control until the indicator starts blinking.

A message appears on the screen and the indicator stops blinking when the remote control is paired.

Parent topic: [Using Basic Projector Features](#)

Selecting an Image Source

If you connected multiple image sources to the projector, such as a computer and DVD player, you may want to switch from one image source to the other.

1. Make sure the connected image source you want to use is turned on.
2. For video image sources, insert a DVD or other video media and press its play button, if necessary.
3. Do one of the following:
 - Press the  Source Search button on the remote control to select either the HDMI1 or HDMI2 image source, and press **Enter**.
 - Press the  home button on the remote control to switch the image source to the Android TV home screen.

Note: If no image signal is detected, check the cable connections between the projector and the image source.

Parent topic: [Using Basic Projector Features](#)

Using Your Projector as a Chromecast

Your projector has Chromecast built-in, allowing you to cast content from Chromecast-enabled apps.

1. Connect your device or computer to the same wireless network as the projector.
2. Open the Chromecast-enabled app and press the  Cast button.
3. Select your projector from the list of devices.

Note: By default, the name of the projector is Projector. To select another name or use a custom name, select the  Android TV settings icon on the remote control.

The app connects and starts casting to the projector.

4. To stop casting, press the  Cast button in the app and choose the disconnect option.

Parent topic: [Using Basic Projector Features](#)

Related tasks

[Setting Up Android TV](#)

Image Aspect Ratio

The projector can display images in different width-to-height ratios called aspect ratios. Normally the input signal from your video source determines the image's aspect ratio setting. However, for certain images you can change the aspect ratio to fit your screen.

If you always want to use a particular aspect ratio for a certain video input source, you can select it using the projector's menus.

[Changing the Image Aspect Ratio](#)

[Available Image Aspect Ratios](#)

Parent topic: [Using Basic Projector Features](#)

Changing the Image Aspect Ratio

You can change the aspect ratio of the displayed image to resize it.

1. Turn on the projector and switch to the image source you want to use.
2. Press the  settings button on the remote control.

3. Select the **Picture** menu and press **Enter**.

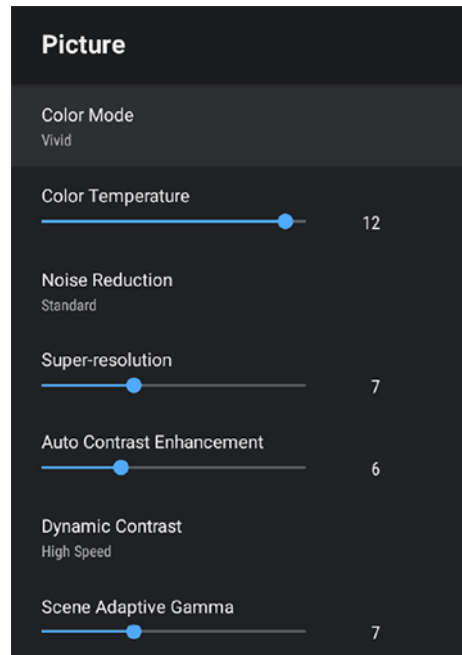

4. Select **Aspect Ratio** and press **Enter**.
5. Select the aspect ratio setting you want to use for your input signal and press **Enter**.
6. Press the ← esc button to exit the menus.

Parent topic: [Image Aspect Ratio](#)

Related references

[Image Quality Settings - Picture Menu](#)

Available Image Aspect Ratios

You can select the following image aspect ratio settings, depending on the input signal from your image source.

Note: Using the aspect ratio function to reduce, enlarge, or split the projected image for commercial purposes or for public viewing may infringe upon the rights of the copyright holder of that image based on copyright law.

Aspect ratio setting	Description
Normal	Displays images using the full projection area and maintains the aspect ratio of the image.
Zoom	Displays images using the full width of the projection area and maintains the aspect ratio of the image.
Full	Displays images using the full width of the projection area, but does not maintain the aspect ratio.

Parent topic: [Image Aspect Ratio](#)

Color Mode

The projector offers different Color Modes to provide optimum brightness, contrast, and color for a variety of viewing environments and image types. You can select a mode designed to match your image and environment, or experiment with the available modes.

[Changing the Color Mode](#)

[Available Color Modes](#)

[Turning On Automatic Luminance Adjustment](#)

Parent topic: [Using Basic Projector Features](#)

Changing the Color Mode

You can change the projector's Color Mode to optimize the image for your viewing environment.

1. Turn on the projector and switch to the image source you want to use.
2. If you are projecting from a DVD player or other video source, insert a disc or other video media and press the play button, if necessary.
3. Press the  Settings button on the remote control.

4. Select the **Picture** menu and press **Enter**.

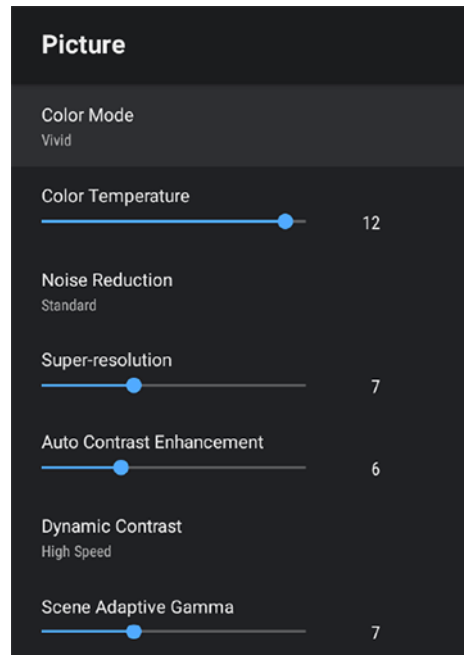

5. Select **Color Mode** and press **Enter**.
6. Use the directional pad to select a color mode setting and press **Enter**.
7. When you are finished, press ← esc.

Parent topic: [Color Mode](#)

Related references

[Image Quality Settings - Picture Menu](#)

Available Color Modes

You can set the projector to use these Color Modes, depending on the input source you are using.

Color Mode	Description
Dynamic	Best for prioritizing brightness

Color Mode	Description
Vivid	Best for enjoying content in a bright environment
Cinema	Best for movies projected in a dark room with natural tone images
Natural	Best for projecting the image as-is (choose this mode when making color adjustments)

Parent topic: [Color Mode](#)

Turning On Automatic Luminance Adjustment

You can turn on the **Dynamic Contrast** setting to automatically optimize the image luminance. This improves the image contrast based on the brightness of the content you project.

1. Turn on the projector and switch to the image source you want to use.
2. Press the  Settings button on the remote control.
3. Select the **Picture** menu and press **Enter**.

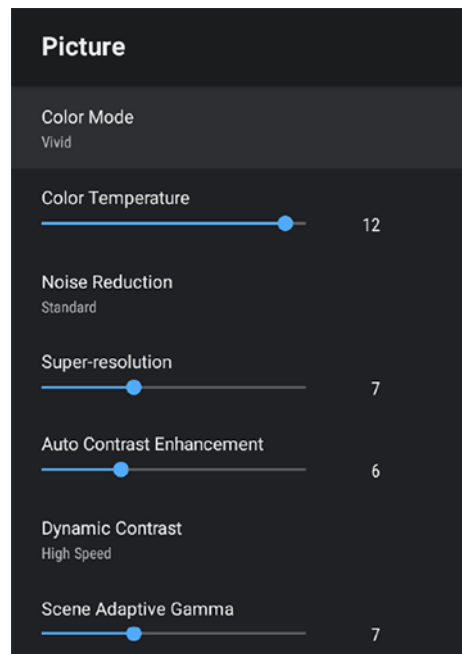

4. Select the **Dynamic Contrast** setting and press **Enter**.
5. Select one of the following options and press **Enter**.
 - **Normal** to adjust brightness at the standard speed.
 - **High Speed** to adjust brightness as soon as the scene changes.
6. Press the ← esc button to exit the menus.

Parent topic: [Color Mode](#)

Related references

[Image Quality Settings - Picture Menu](#)

Adjusting Image Quality in Detail

You can fine-tune various aspects of how quality and colors are displayed in your projected images.

Note: To optimize the color tone according to the scene and to make the image more vivid, correct the image by adjusting the **Scene Adaptive Gamma** setting.

1. Turn on the projector and display an image.
2. Press the  settings button on the remote control.

3. Select the **Picture** menu and press the **Enter** button.

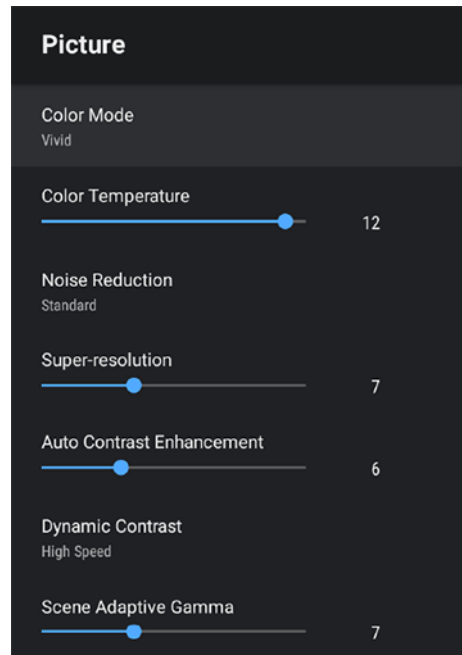

4. Select **Custom Settings** and press the **Enter** button.
5. Adjust each setting in the projector's Picture menu, as necessary:
 - Adjust the **Brightness** setting to lighten or darken the color.
 - Adjust the **Contrast** setting to adjust the difference between light and dark areas of the image.
 - Adjust the **Saturation** setting to adjust the overall vividness of the colors.
 - Adjust the **Tint** setting to adjust the balance of green to magenta tones in the image.
 - Adjust the **Sharpness** setting to adjust the outline of the image.
6. When you are finished, press the ← esc button to exit the menus.

Note: You can set the overall color tone by adjusting the **Color Temperature** setting in the Picture menu if the image is tinted too blue or red.

Parent topic: [Using Basic Projector Features](#)

Adjusting the Image Resolution

You can adjust the image resolution to project a clear image with an emphatic texture and material feel.

1. Turn on the projector and switch to the image source you want to use.
2. Press the  settings button on the remote control.
3. Select the **Picture** menu and press the **Enter** button.

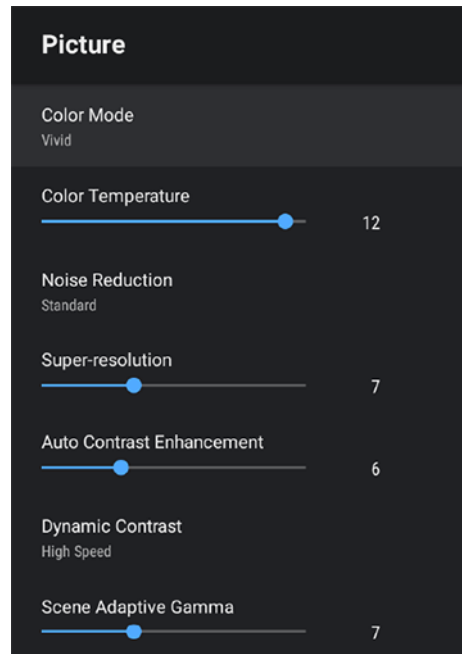



4. Adjust each setting in the projector's Picture menu individually as necessary.
 - Adjust the **Noise Reduction** setting to reduce flickering in images.
 - Adjust the **Super-resolution** setting to reduce blurring when projecting low-resolution images.
 - Adjust the **Auto Contrast Enhancement** setting to create a clearer and sharper image by automatically adjusting the contrast.
5. When you are finished, press the ← esc button to exit the menus.

Parent topic: [Using Basic Projector Features](#)

Using Frame Interpolation

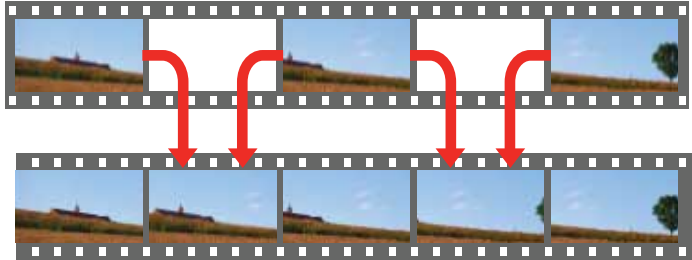
You can use the projector's Frame Interpolation feature to smooth fast-moving video by comparing consecutive image frames and inserting an intermediate image frame between them.



1. Turn on the projector and switch to the input source you want to use.
2. Press the  settings button on the remote control.
3. Select the **Picture** menu and press **Enter**.

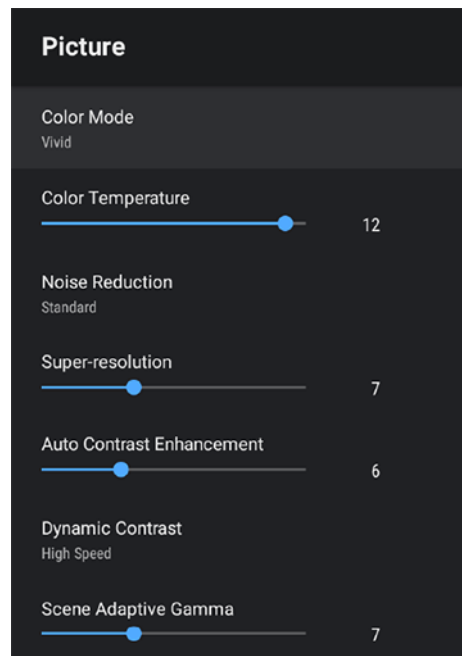

4. Select the **Frame Interpolation** setting and press **Enter**.
5. Select the level of interpolation and press **Enter**.
6. When you are finished, press the ← esc button to exit the menus.



Parent topic: [Using Basic Projector Features](#)

Controlling the Volume with the Volume Buttons

You can use the **Volume** buttons on the remote control to adjust the volume of your projected content. The volume buttons control the projector's internal speaker system or any compatible external speakers or headphones you connected to the projector, except those connected to the **Optical Out** port.

You must adjust the volume separately for each connected input source.

Warning: Do not start playback at a high volume. Sudden loud noises may cause hearing loss. Always lower the volume before turning off the projector. Gradually increase the volume after turning the projector on.

1. Turn on the projector and start a presentation that includes audio.
2. To lower or raise the volume, press the  volume up or  volume down button on the projector's remote control.

A volume gauge appears on the screen.

Parent topic: [Using Basic Projector Features](#)

Changing the Sound Mode

You can change the projector's sound mode to provide optimal sound for a variety of image types. These settings are only available for sound that is output from the projector's speakers.

1. Turn on the projector and start a video.
2. Press the  settings button on the remote control.

3. Select the **Sound** menu and press **Enter**.

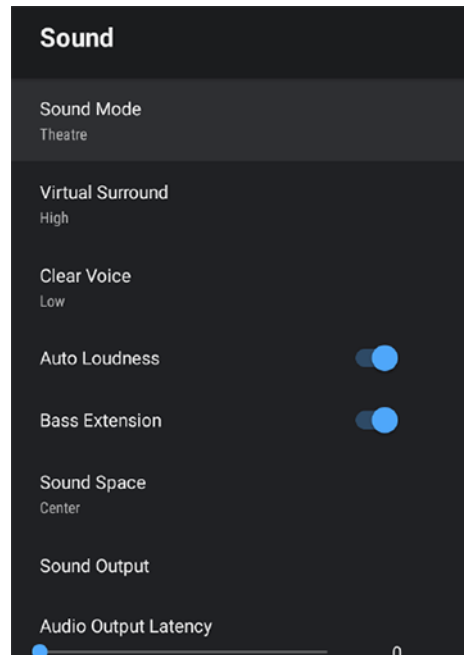

4. Select **Sound Mode** and press **Enter**.
5. Select a sound mode and press **Enter**.
6. Select any additional sound settings according to your listening environment.
7. When you are finished, press the ← esc button to exit the menus.

Parent topic: [Using Basic Projector Features](#)

Related references

[Sound Quality Settings - Sound Menu](#)

Adjusting Projector Features

Follow the instructions in these sections to use your projector's feature adjustments.

[Using the Projector as a Bluetooth Speaker](#)

[Operating Connected Devices Using the HDMI Link Features](#)

[Adjusting the Color Convergence \(Panel Alignment\)](#)

[Muting the Sound Temporarily](#)

[Shutting Off the Picture Temporarily](#)

[Changing the Projected Image Using Flexible Picture](#)

[Projector Security Features](#)

[Updating the Firmware](#)



[Resetting the Projector](#)

Using the Projector as a Bluetooth Speaker

You can use the projector's speakers to output audio from a compatible device connected by Bluetooth.

Note: Bluetooth audio devices are not supported in some countries and regions. You cannot connect multiple audio/video devices by Bluetooth at the same time. You may not be able to connect depending on type of device and its Bluetooth standards. Several attempts may be required before pairing is successful. Even when connecting within the specified communication distance, connections can be lost due to the signal status.

1. Press the  settings button on the remote control.
2. Select **Bluetooth Speaker Mode** and press the **Enter** button to enable it.
3. Enable the Bluetooth function on the device you want to connect to and select **Projector** from the available device list. See the documentation for the connected device for more information.

Note: You can change the name displayed for the projector. Press the  Android TV settings button on the remote control and then select **Device Preferences > About > Device name**. There is a delay in the audio output from any Bluetooth audio device. If you want to temporarily turn off the projected image, press the  blank button on the projector or remote control. To cancel a Bluetooth connection, disconnect from the connected device.

4. To exit Bluetooth Speaker mode, disable it from the projector's menu.

Note: While the projector is in Bluetooth Speaker mode, you can connect input devices such as smartphones or tablets, but you cannot pair output devices such as headphones or external speakers. If you are having trouble pairing speakers or headphones, make sure the Bluetooth Speaker mode is disabled.

You can also output the projector's audio to connected Bluetooth audio devices, such as speakers or headphones. See the link below.

Parent topic: [Adjusting Projector Features](#)

Related references

[Bluetooth Specifications](#)

Related tasks

[Connecting to a Bluetooth Audio Device](#)

Operating Connected Devices Using the HDMI Link Features

You can use the remote control to control certain features of devices connected to the projector's HDMI ports.

Note: You must use an HDMI cable that supports the CEC standard and the connected device must also be configured. Some connected devices or functions of those devices may not operate properly even though they meet the HDMI CEC standard. See the documentation supplied with the device for more information.

1. Press the  settings button on the remote control.

2. Select the **Settings** menu and press **Enter**.

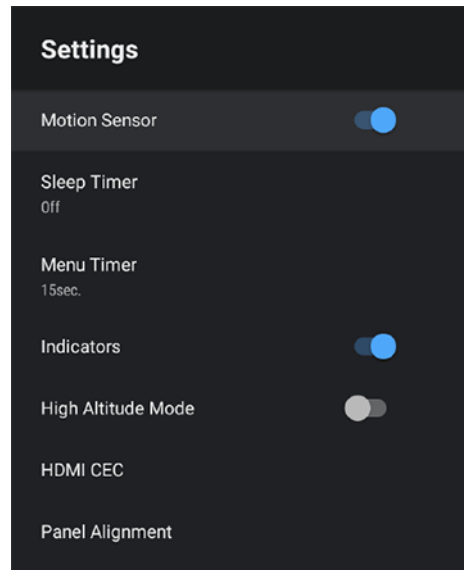

3. Select **HDMI CEC** and press **Enter**.
4. Select the **HDMI CEC** setting and press **Enter** to enable it, if necessary.
5. Select the following HDMI Link options as necessary:
 - **Device Auto Power Off**: select whether to automatically turn off the connected device when you turn off the projector.
 - **Auto Language Change**: select whether to switch the language settings of the connected device to match the projector's language settings.
 - **HDMI2 ARC**: select whether to output audio to an HDMI ARC compatible audio/video system.
6. When you are finished, press ← esc.

Parent topic: [Adjusting Projector Features](#)

Adjusting the Color Convergence (Panel Alignment)

You can use the Panel Alignment feature to manually adjust the color convergence (the alignment of the red and blue colors) in the projected image. You can adjust the pixels horizontally and vertically up to ± 3 pixels in 0.125 pixel increments.

Note: You can adjust only the red or blue color convergence. Green is the standard color panel and cannot be adjusted.

Note: Image quality may decline after you perform Panel Alignment.

Note: Images for pixels that extend beyond the edge of the projected screen are not displayed.

1. Turn on the projector.
2. Press the  settings button on the remote control.
3. Select the **Settings** menu and press **Enter**.

You see a screen like this:

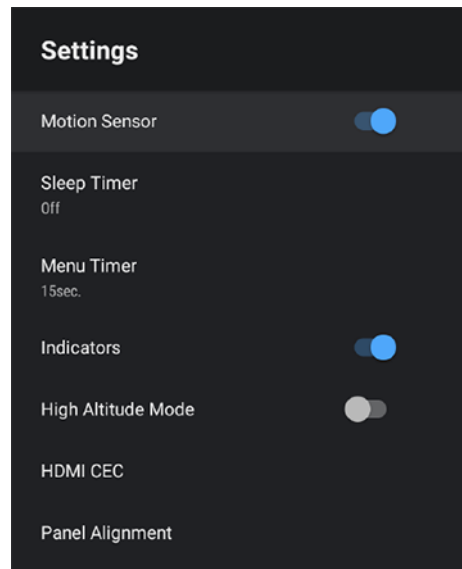

4. Select the **Panel Alignment** setting and press **Enter**.
5. Set the **Panel Alignment** setting to **On**.
6. Select the **Select Color** setting and choose one of the following:
 - **R** to adjust the red color convergence.
 - **B** to adjust the blue color convergence.

7. Select the **Pattern Color** setting and choose one of the following as the grid color you want to use when making adjustments. (The available color varies depending on the Select Color setting.)
 - **R/G/B** to display the grid color in white.
 - **R/G** to display the grid color in yellow. (R/G is only displayed when Select Color is set to R.)
 - **G/B** to display the grid color in cyan. (G/B is only displayed when Select Color is set to B.)
8. Select **Next** and press **Enter**.
9. Select the **Select Method** setting and choose one of the following:
 - Select **Whole Panel** to adjust the whole panel at the same time, and continue with the next step.
 - Select **Four Corners** to adjust the corners of the panel one at a time, and skip to step 13.
10. Use the directional pad on the remote control to adjust the color alignment of the color you selected for the **Select Color** setting.
11. When you are finished adjusting the screen, press **Enter**.

Note: Adjustment affects the grid lines in the entire screen.

12. Select one of the following options:
 - Select **Four Corners** to fine-tune your adjustments.
 - Select **Exit** to finish making adjustments.
13. Use the directional pad on the remote control to adjust the color alignment in the corner of the screen.
14. Press the **Enter** button to move to the next corner of the screen.
15. When you are finished adjusting each corner of the screen, press **Enter**.
16. Do one of the following:
 - If your projector's panel alignment is now correct, select **Exit** and press **Enter** to return to the Panel Alignment menu.
 - If your projector needs additional panel alignment, select **Fine Adjustment** and press **Enter**. Use the directional pad on the remote control to highlight the corner of any misaligned box on the screen, press **Enter**, make any necessary adjustments, and press **Enter** again. Repeat this step as necessary for the other intersections.

Parent topic: [Adjusting Projector Features](#)

Muting the Sound Temporarily

You can temporarily mute the sound from your projection.

1. Press the  mute button on the remote control to temporarily mute the audio.

The audio from the projection is interrupted.

2. To turn the audio back on, press the  mute button again.

Parent topic: [Adjusting Projector Features](#)

Shutting Off the Picture Temporarily

You can temporarily turn off the projected picture if you want to redirect your audience's attention during a presentation. Any sound or video action continues to run, however, so you cannot resume projection at the point that you stopped it.

1. Press the  blank button on the projector or remote control to temporarily stop projection.

The light source turns off and projection is interrupted.

2. To turn the picture back on, press the  blank button again.



Parent topic: [Adjusting Projector Features](#)

Changing the Projected Image Using Flexible Picture

You can use the Flexible Picture features to change the projected image without moving the projector.

1. Turn on the projector and display an image.
2. Press the  Flexible Picture menu button on the remote control.

Note: This button is not available when the Installation menu is displayed.

3. You can adjust the following settings:
 - Use the  brightness up or  brightness down buttons on the remote control to adjust the image size. You can reduce the image size to about 30%.

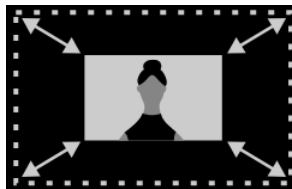

- If you made the image smaller, use the directional pad on the remote control to change the position of the image.

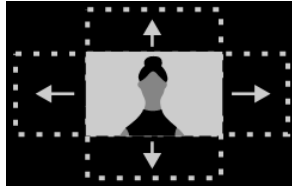

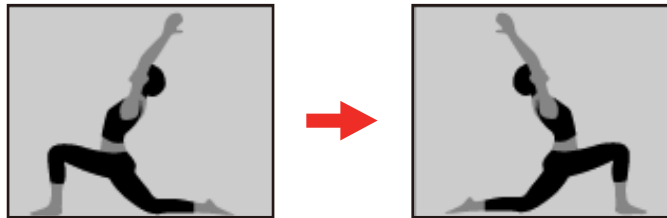

- Press the  Flexible Picture menu button on the remote control to flip the image horizontally. Press the button again to flip the image back.

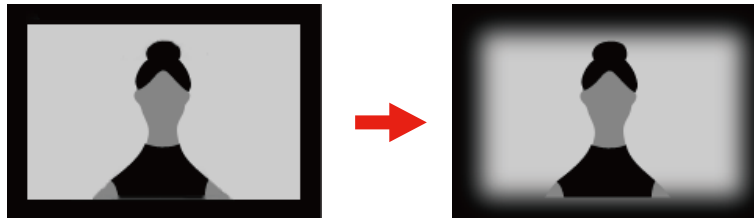

- Press the  blank button on the remote control to blur the edges of the image so that it blends into the wall you're projecting onto.



Note: Press the  settings button to reset all of the Flexible Picture settings.

4. Press the  esc button to exit the menu.

Parent topic: [Adjusting Projector Features](#)

Projector Security Features

You can secure your projector to deter theft or prevent unintended use by setting up the following security features:

- Security cabling to physically cable the projector in place.

[Installing a Security Cable](#)

Parent topic: [Adjusting Projector Features](#)

Installing a Security Cable

You can use the security slot on the side of the projector to attach a Kensington lock. See your local computer or electronics dealer for purchase information.

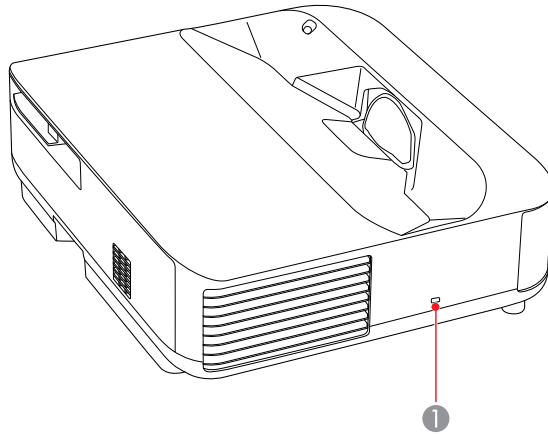

1 Security slot

Parent topic: [Projector Security Features](#)

Updating the Firmware

You can get the latest version of the projector firmware over a network.

When the latest projector firmware is available, a notification is automatically displayed on the screen. Follow the on-screen instructions to update the firmware.

1. Press the  apps button on the remote control.

You see a menu like this:

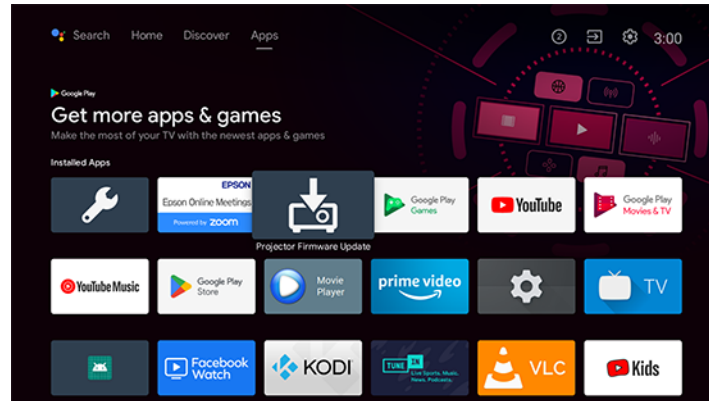

2. Select **Projector Firmware Update** from the application list and press **Enter**.
3. Follow the on-screen instructions to update the firmware.

Caution: Do not turn off the projector while updating the firmware.

Parent topic: [Adjusting Projector Features](#)

Resetting the Projector

You can reset the projector and all settings to their factory default values.

Note: Write down the settings you do not want to lose before resetting the projector. When you reset the projector, all information, including installed apps, Google account login information, and Projector Settings, is deleted.

1. Press the  Android TV settings button on the remote control.
2. Select **Device Preferences**, select **About**, then select **Factory Reset**.
3. Follow the on-screen instructions to reset the projector.

Parent topic: [Adjusting Projector Features](#)

Adjusting the Menu Settings

Follow the instructions in these sections to access the projector menu system and change projector settings.

- [Using the Projector's Menus](#)
- [Image Quality Settings - Picture Menu](#)
- [Sound Quality Settings - Sound Menu](#)
- [Projector Installation Settings - Installation Menu](#)
- [Projector Feature Settings - Settings Menu](#)
- [Projector Information Settings - Information Menu](#)

Using the Projector's Menus

You can use the projector's menus to adjust the settings that control how your projector works. The projector displays the menus on the screen.

1. Press the  Settings button on the remote control.

You see the Projector Settings menu.

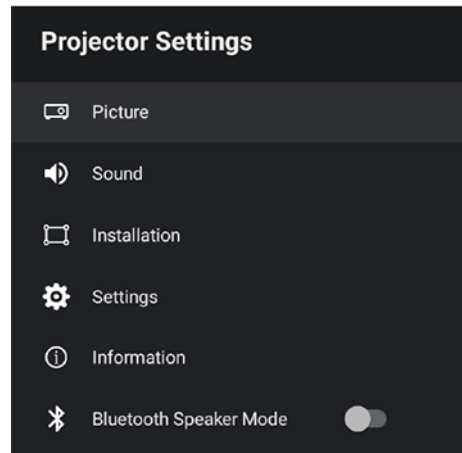

2. Press the up or down arrow button on the remote control to move through the menu selections.
3. To change settings in the displayed menu, press **Enter**.

4. Use the arrow and **Enter** buttons to adjust the menu settings as desired.
5. When you finish changing settings on a menu, press ← esc to exit the menus.

Parent topic: [Adjusting the Menu Settings](#)

Image Quality Settings - Picture Menu

Settings on the Picture menu let you adjust the quality of your image for the input source you are currently using.

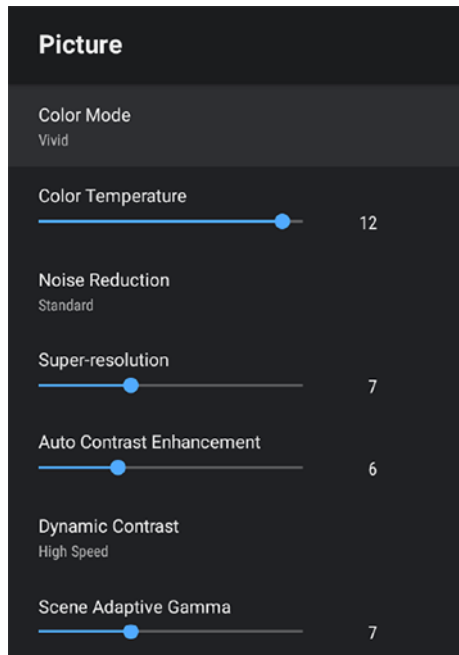

Setting	Options	Description
Color Mode	See the list of available Color Modes	Adjusts the vividness of image colors for various image types and environments

Setting	Options	Description
Color Temperature	Varying levels available	Sets the color temperature according to the selected color mode; lower values tint the image red, and higher values tint the image blue
Noise Reduction	Strong Standard Weak Off	Reduces flickering in analog images Note: This setting is not available when Image Processing is set to Fast .
Super-resolution	Varying levels available	Sharpens blurred images when projecting low-resolution images Note: This setting is not available when Image Processing is set to Fast .
Auto Contrast Enhancement	Varying levels available	Automatically adjusts the contrast of the projected image to create a clearer and sharper image
Dynamic Contrast	Off Normal High Speed	Adjusts the projected luminance based on the image brightness when certain Color Modes are selected
Scene Adaptive Gamma	Varying levels available	Adjusts the coloring according to the scene to obtain a more vivid image; larger numbers enhance the contrast
Frame Interpolation	Off Low Normal High	Adjusts the smoothness of image movement Note: This setting is not available when Image Processing is set to Fast .

Setting	Options	Description
Custom Settings	Brightness Contrast Saturation Tint Sharpness	<p>Brightness: Lightens or darkens the overall image</p> <p>Note: This function is not available when the light source brightness dims because the surrounding temperature gets too high or when a problem has occurred.</p> <p>Contrast: Adjusts the difference between light and dark areas of the image</p> <p>Saturation: Adjusts the intensity of the image colors</p> <p>Tint: Adjusts the balance of green to magenta tones in the image</p> <p>Sharpness: Adjusts the sharpness or softness of image details</p>
Dynamic Tone Mapping	On Off	Automatically adjusts to the optimum HDR level according to the scene
HDR	Varying levels available	<p>Changes the range of dark and bright areas in images</p> <p>Note: This setting is not available when Dynamic Tone Mapping is set to On.</p>
Aspect Ratio	Normal Full Zoom	Sets the aspect ratio for the selected input source

Setting	Options	Description
HDMI Video Range	Auto Full Limited	Sets the video range to match the setting of the device connected to the HDMI input port
Image Processing	Fast Fine	Improves the response speed for images projected at high speed. If you select Fast , the following functions are disabled to speed up the response speed. <ul style="list-style-type: none"> • Noise Reduction • Frame Interpolation • Super-resolution
EDID	HDMI1 HDMI2	Describes the display capabilities of your projector when the selected input source is HDMI. Change this setting as necessary according to the current input source's resolution. You can adjust settings for individual input sources without changing the input source.

Parent topic: [Adjusting the Menu Settings](#)

Sound Quality Settings - Sound Menu

Settings on the Sound menu allow you to optimize the audio for a variety of projected content. You can select from presets or experiment with available modes.

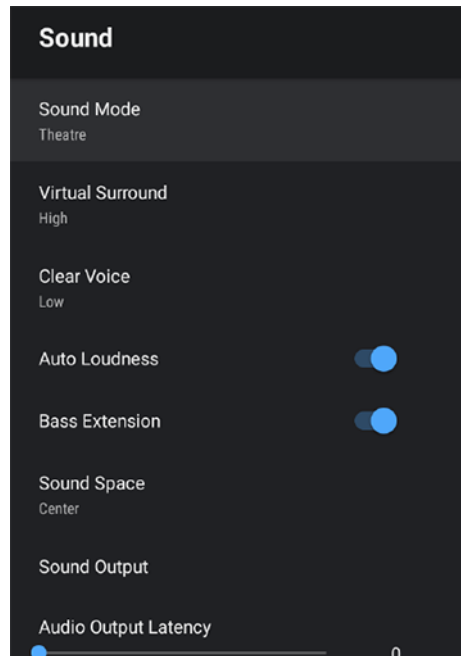

Setting	Options	Description
Sound Mode	Theatre TV Studio Stadium Concert Karaoke Mode	Sets a sound mode for the projector's speakers based on the type of playback content (music, movie, etc.) Theatre: Recreates the acoustic environment of a movie theatre with realistic and powerful sound. TV: Ideal for watching news, documentaries, and other TV shows. Studio: Balanced sound quality to reproduce sound as the creators and artists intended. Stadium: Reproduces the stadium and crowd environment, providing clear, live voice playback best for sports. Concert: Reproduces the echoes and expanse of a concert venue. Karaoke Mode: Reproduces the echoes and expanse of a concert venue without sacrificing the vocal effects of a microphone or karaoke app.
Virtual Surround	High Low Off	Adjusts the strength of the surround effect. This setting is saved for each Sound Mode
Clear Voice	High Low Off	Adjusts output so that voices can be heard clearly. This setting is saved for each Sound Mode
Auto Loudness	On Off	Automatically corrects the balance between high and low tones in the audio so that they are not out of balance, even when playing at low volume
Bass Extension	On Off	Emphasizes the bass levels in the audio output

Setting	Options	Description
Sound Space	Right Center Left	Adjusts the sound quality to suit your viewing position
Sound Output	PCM Auto	<p>Selects the sound output device and format for input sources</p> <p>Note: If sound is not output correctly, select PCM.</p> <p>Speaker/Optical (PCM) or Speaker/Optical (Auto): outputs sound from the projector's speakers and to the Optical Out port in PCM (2 ch) format or higher quality (Auto).</p> <p>ARC (PCM) or ARC (Auto): outputs sound to an ARC compatible external audio device connected to the HDMI2 (eARC/ARC) port in PCM (2 ch) format or higher quality (Auto).</p> <p>eARC: outputs higher quality sound to an eARC compatible external audio device connected to the HDMI2 (eARC/ARC) port.</p> <p>(Auto) supports the L-PCM (2 ch), AC-3 (up to 5.1 ch), and DTS (up to 5.1 ch) audio codecs.</p> <p>Note: When playing Android TV content, audio is output in L-PCM (2 ch).</p>

Setting	Options	Description
Audio Output Latency	Varying levels available	<p>Adjusts the audio latency. If the audio is fast, select a higher value. This setting is only available for the following types of audio:</p> <ul style="list-style-type: none"> • audio output from the projector's speaker • audio output from the HDMI2 (eARC/ARC) port • audio output from the Optical Out port

Parent topic: [Adjusting the Menu Settings](#)

Projector Installation Settings - Installation Menu

Settings on the Installation menu let you correct distortion in the projected image by following the on-screen prompts.

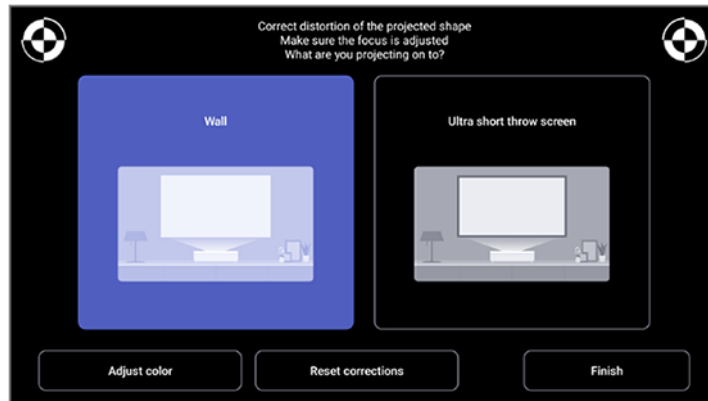

You can make the following corrections to the image shape and the projected image from this menu:

- Quickly correct distortion in the projected image using the Epson Setting Assistant app
- Correct the position of the four corners of the projected image or fine-tune point correction using the remote control
- Straighten the top of the projected image using the remote control

- Select **Adjust color** to compensate the color of the projected image to match colored walls

Note: When you use the Epson Setting Assistant app, the Flexible Picture settings are reset.

Parent topic: [Adjusting the Menu Settings](#)

Projector Feature Settings - Settings Menu

Options on the Settings menu let you customize various projector features.

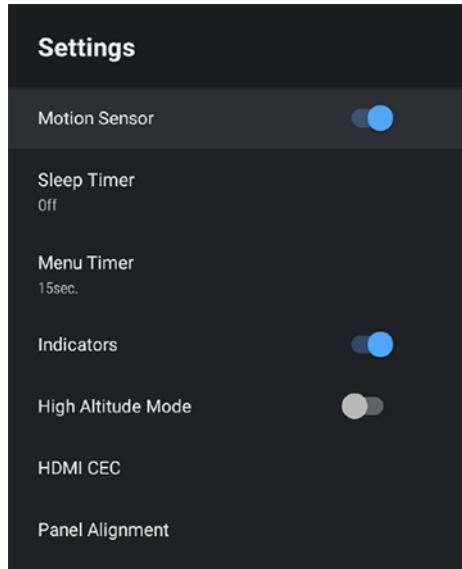

Setting	Options	Description
Motion Sensor	On Off	Automatically reduces the brightness of the light source for safety when someone comes close to the projector window while projecting
Sleep Timer	0 to 120 minutes	Sets the interval before the projector automatically turns off

Setting	Options	Description
Menu Timer	0 to 240 seconds	Sets the interval before automatically closing the projector's menu
Indicators	On Off	Allows for control of the indicator lights on the projector. If this setting is Off , the indicator lights on the projector are only lit when an error or warning occurs
High Altitude Mode	On Off	Regulates the projector's operating temperature at altitudes above 4921 feet (1500 m)
HDMI CEC	CEC Control	<p>Adjusts the HDMI CEC options that allow the projector remote to control HDMI-connected devices that support the CEC standard</p> <p>HDMI CEC: allows for control of the connected device using the projector's remote control. If this setting is On, the projector automatically turns on when the device is turned on or playback is started on the device</p> <p>Device Auto Power Off: automatically turns off the connected device when you turn off the projector</p> <p>Auto Language Change: automatically switches the language settings of the connected device according to the projector's language setting</p> <p>HDMI2 ARC: enables HDMI ARC on the HDMI2 (eARC/ARC) port</p>

Setting	Options	Description
Panel Alignment	Panel Alignment Select Color Pattern Color	Adjusts the color convergence (the alignment of the red and blue colors) in the projected image Panel Alignment: select On to correct color misalignment in the projected image Select Color: select the color to correct Pattern Color: selects the pattern used for color correction. The available pattern colors depend on the Select Color setting

Parent topic: [Adjusting the Menu Settings](#)

Projector Information Settings - Information Menu

Settings on the Information menu let you display information about the licenses and privacy statements, and set whether or not to allow the acquisition of operation logs.

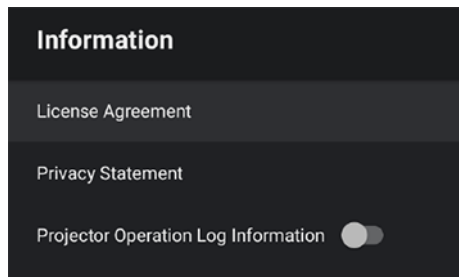

Setting	Options	Description
License Agreement	—	Displays the license agreement
Privacy Statement	—	Displays the privacy statement

Setting	Options	Description
Projector Operation Log Information	On Off	Sets whether or not to allow Epson to receive projector operation logs

Parent topic: [Adjusting the Menu Settings](#)

Maintaining and Transporting the Projector

Follow the instructions in these sections to maintain your projector and transport it from place to place.

[Projector Maintenance](#)

[Air Filter and Vent Maintenance](#)

[Replacing the Remote Control Batteries](#)

[Transporting the Projector](#)

Projector Maintenance

Your projector needs little maintenance to keep working at its best.

You may need to clean the projection window and motion sensor periodically, and clean the air filter and air vents to prevent the projector from overheating due to blocked ventilation.

The only parts you should replace are the air filter and remote control batteries. If any other part needs replacing, contact Epson or an authorized Epson servicer.

This projector uses a sealed laser light source which does not need servicing and cannot be replaced.

Warning: Before cleaning any part of the projector, turn it off, unplug the power cord, and let it cool down. Never open any cover on the projector, except as specifically explained in this manual. Dangerous electrical voltages in the projector can injure you severely.

Warning: Do not try to service this product yourself, except as specifically explained in this manual. Refer all other servicing to Epson qualified servicers.

[Cleaning the Projection Window](#)

[Cleaning the Motion Sensor](#)

[Cleaning the Projector Case](#)

Parent topic: [Maintaining and Transporting the Projector](#)

Cleaning the Projection Window

Clean the projection window periodically, or whenever you notice dust or smudges on the surface.

Warning: Before cleaning the projection window, turn off the projector and unplug the power cord.

- To remove dust or smudges, gently wipe the projection window with clean and dry lens-cleaning paper.

Caution: Do not wipe the projection window right after you turn off the projector or you may damage it.

- If the projection window is dusty, blow off the dust and then wipe the projection window.

Warning: Do not use any flammable gas sprays such as air dusters to blow off dust. The high heat generated by the projector may cause a fire.

Caution: Do not use canned air, or the gases may leave a flammable residue. Do not use glass cleaner or any harsh materials to clean the projection window and do not subject the projection window to any impacts or you may damage it.

Parent topic: [Projector Maintenance](#)

Related tasks

[Turning Off the Projector](#)

Cleaning the Motion Sensor

Clean the projector's motion sensor periodically, or if you see a message telling you to remove any obstacles that are interfering with the projection area.

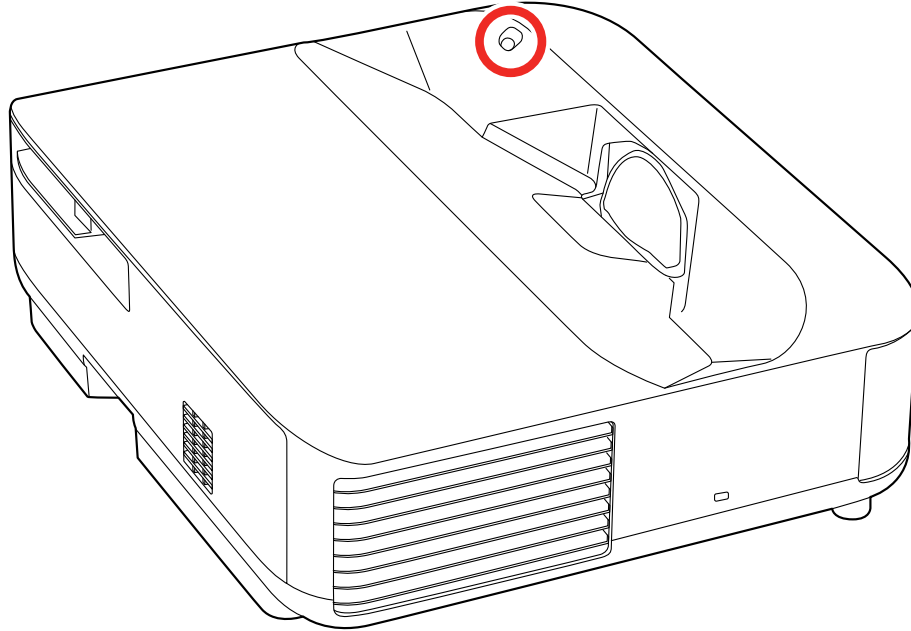

To remove dust or smudges, gently wipe the sensor with lens-cleaning paper.

Warning: Do not use a lens cleaner that contains flammable gas to clean the motion sensor. The high heat generated by the projector may cause a fire.

Caution: Do not use glass cleaner or any harsh materials to clean the motion sensor and do not subject it to any impacts. Damage on the surface of the sensor may cause a malfunction.

Parent topic: [Projector Maintenance](#)

Cleaning the Projector Case

Before cleaning the projector case, turn off the projector and unplug the power cord.

- To remove dust or dirt, use a soft, dry, lint-free cloth.

- To remove stubborn dirt, use a soft cloth moistened with water and mild soap. Do not spray liquid directly on the projector.

Caution: Do not use wax, alcohol, benzine, paint thinner, or other chemicals to clean the projector case. These can damage the case. Do not use canned air, or the gases may leave a flammable residue.

Parent topic: [Projector Maintenance](#)

Related tasks

[Turning Off the Projector](#)

Air Filter and Vent Maintenance

Regular filter maintenance is important to maintaining your projector. Your Epson projector is designed with an easily accessible, user-replaceable filter to protect your projector and make regular maintenance simple. Filter maintenance intervals will depend on the environment.

If regular maintenance is not performed, your Epson projector will notify you when the temperature inside the projector has reached a high level. Do not wait until this warning appears to maintain your projector filter as prolonged exposure to high temperatures may reduce the life of your projector or laser.

Damage due to the failure to properly maintain the projector or its filter may not be covered by the projector's Limited Warranty.

[Cleaning the Air Filter and Vents](#)

[Replacing the Air Filter](#)

[Cleaning the Air Vents](#)

Parent topic: [Maintaining and Transporting the Projector](#)

Cleaning the Air Filter and Vents

Clean the projector's air filter or vents if they get dusty, or if you see a message telling you to clean them. It is recommended that you clean these parts every 12000 hours, or more often if you use the projector in an environment that is dustier than expected.

Caution: Do not use water or any detergent to clean the air filter. Do not use canned air, or the gases may leave a flammable residue.

1. Turn off the projector and unplug the power cord.

2. Slide the air filter cover latch and pull out the air filter cover.

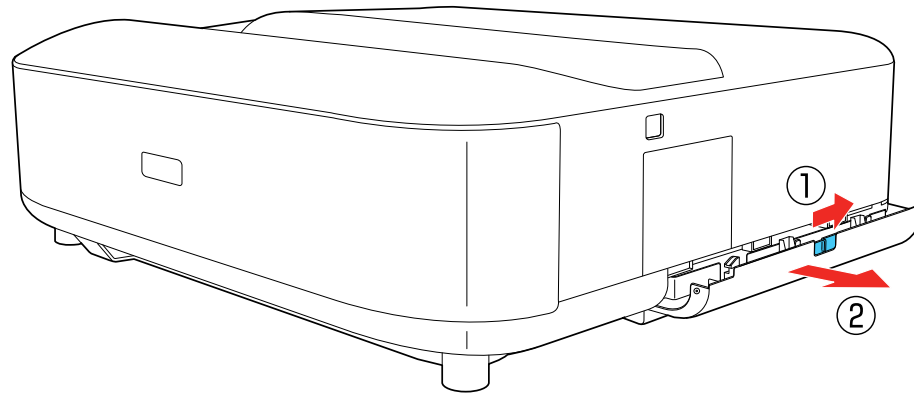

3. Pull the air filter out of the projector.

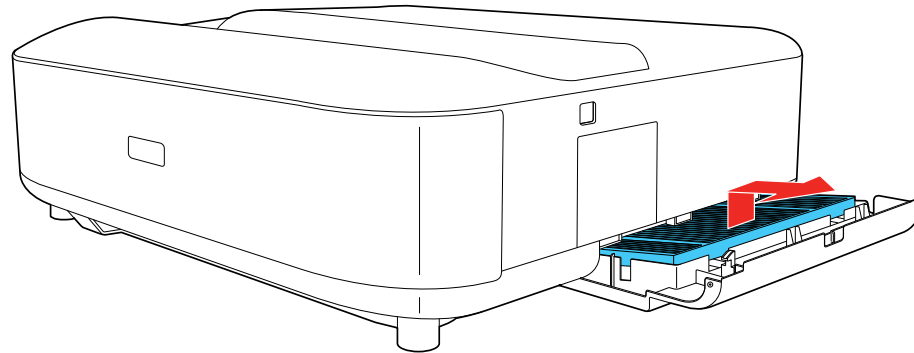

4. Vacuum the front of the air filter (the side with the tabs) to remove any remaining dust.

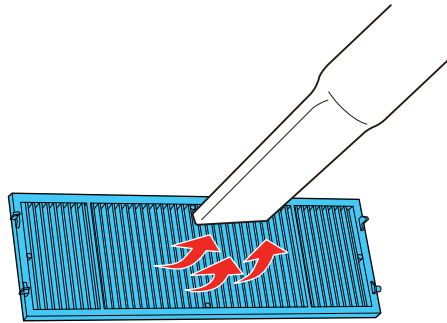

Caution: Do not rinse the air filter in water, or use any detergent or solvent to clean it. Do not use canned air; the gases may leave a flammable residue, or push dust and debris into the projector's optics or other sensitive areas.

Note: If dust is difficult to remove or the air filter is damaged, replace the air filter.

5. Place the air filter back in the projector with the four tabs facing down as shown.

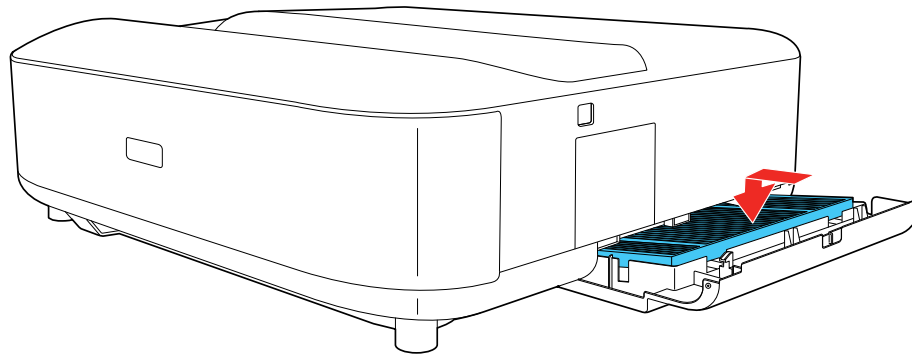

6. Close the air filter cover until it clicks into place.

Caution: Do not try to force the air filter cover closed if the tabs of the air filter are facing up. You could damage the projector.

Parent topic: [Air Filter and Vent Maintenance](#)

Related references

[Optional Equipment and Replacement Parts](#)

Related tasks

[Turning Off the Projector](#)

Replacing the Air Filter

You need to replace the air filter in the following situations:

- After cleaning the air filter, you see a message telling you to clean or replace it
- The air filter is torn or damaged

You can replace the air filter while the projector is placed on a table.

1. Turn off the projector and unplug the power cord.
2. Slide the air filter cover latch and pull out the air filter cover.

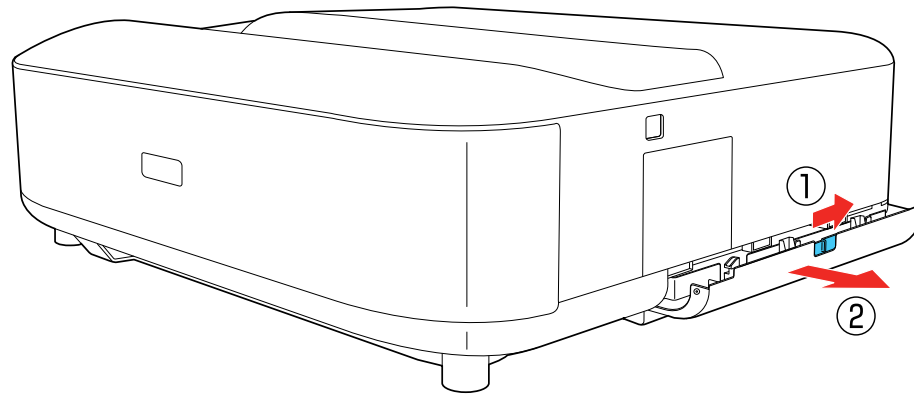

3. Pull the air filter out of the projector.

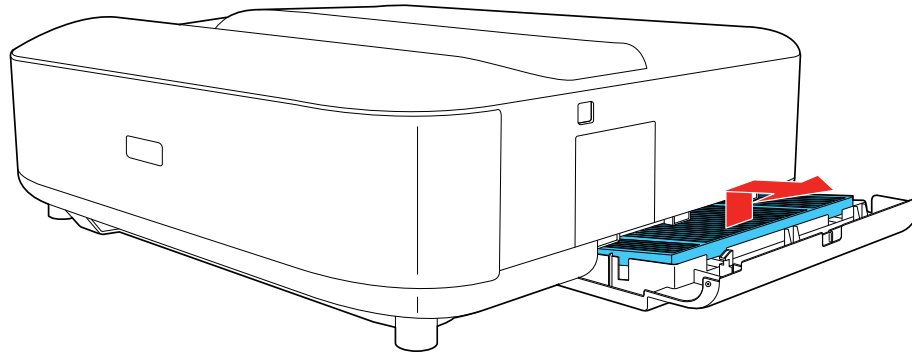

Note: Air filters contain polypropylene. Dispose of used air filters according to local regulations.

4. Place the new air filter in the projector as shown (with the four tabs facing down).

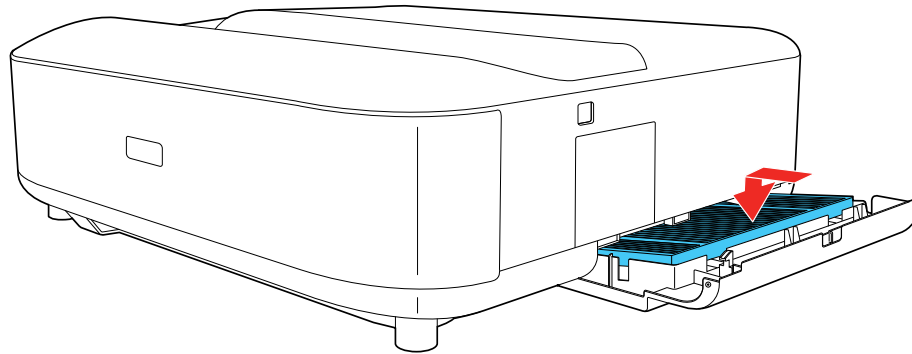

Caution: Do not try to force the air filter cover closed if the tabs of the air filter are facing up. You could damage the projector.

5. Close the air filter cover and press until it clicks into place.

Parent topic: [Air Filter and Vent Maintenance](#)

Related references

[Optional Equipment and Replacement Parts](#)

Cleaning the Air Vents

Clean the projector's air vents if they get dusty, or if you see a message telling you to clean them.

1. Turn off the projector and unplug the power cord.
2. Turn the projector upside down.
3. Carefully remove the dust using a vacuum cleaner or a brush.

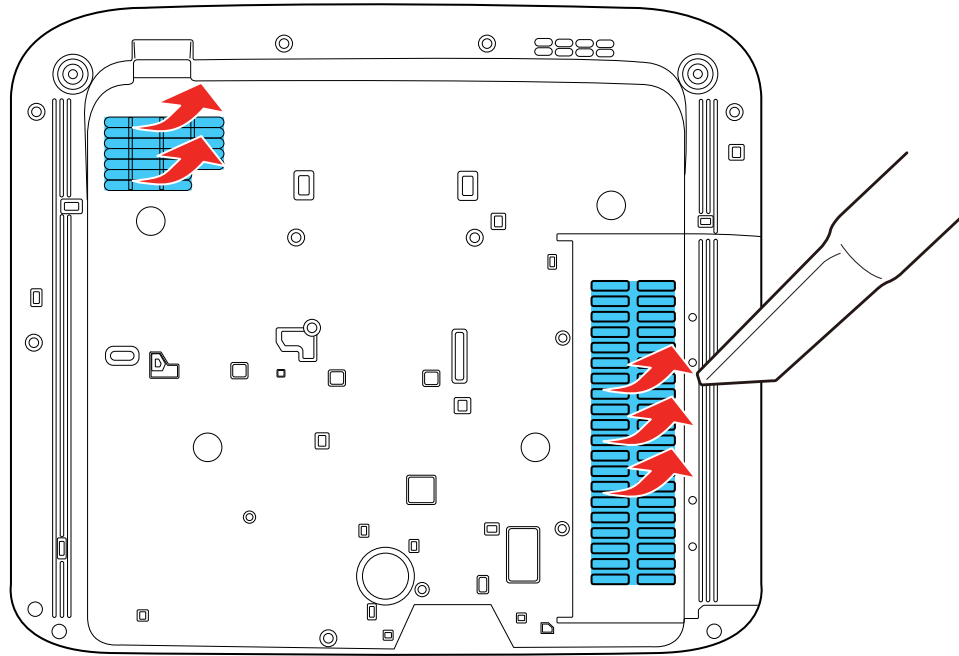

Caution: Do not use canned air. The gases may leave a flammable residue or push dust and debris into the projector's optics or other sensitive areas.

Parent topic: [Air Filter and Vent Maintenance](#)

Replacing the Remote Control Batteries

The remote control uses two AAA manganese or alkaline batteries. Replace the batteries as soon as they run out.

Caution: Use only the type of batteries specified in this manual. Do not install batteries of different types, or mix new and old batteries.

1. Open the battery cover as shown.

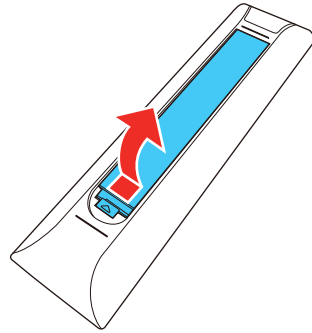

2. Remove the old batteries.

Warning: If the battery fluid has leaked, wipe it away with a soft cloth and avoid getting the fluid on your hands. If it gets on your hands, wash them immediately to avoid injury.

3. Insert the batteries with the + and – ends facing as shown.

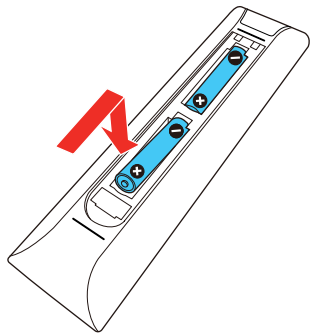

Warning: Make sure the batteries are inserted in the correct positions. If the batteries are not inserted correctly, they could explode or leak, causing a fire, injury, or damage to the product.

4. Close the battery cover and press it down until it clicks into place.

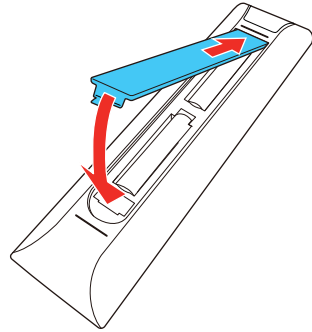

Warning: Dispose of used batteries according to local regulations. Do not expose batteries to heat or flame. Keep batteries out of the reach of children; they are choking hazards and are very dangerous if swallowed.

Parent topic: [Maintaining and Transporting the Projector](#)

Transporting the Projector

The projector contains precision parts, some of which are glass. Follow these guidelines to transport, ship, or store the projector safely.

- Remove any equipment connected to the projector.
- When transporting the projector a long distance or as checked luggage, pack it in a firm box with cushioning around it and mark the box "Fragile."
- When shipping the projector for repairs, place it in its original packing materials, if possible, or use equivalent materials with cushioning around the projector. Mark the box "Fragile."

Note: Epson shall not be liable for any damages incurred during transportation.

Parent topic: [Maintaining and Transporting the Projector](#)

Solving Problems

Check the solutions in these sections if you have any problems using the projector.

[Projection Problem Tips](#)

[Projector Light Status](#)

[Solving Image or Sound Problems](#)

[Solving Projector or Remote Control Operation Problems](#)

[Solving Network Problems](#)

[Where to Get Help \(U.S. and Canada\)](#)

[Where to Get Help \(Latin America\)](#)

Projection Problem Tips

If the projector is not working properly, try turning it off and unplugging it. Then plug it back in and turn it on.

If this does not solve the problem, check the following:

- The Status light on the projector may indicate what the problem is.
- The solutions in this manual can help you solve many problems.

If none of these solutions help, you can contact Epson for technical support.

Note: After repairing the projector, Epson may return the projector to you in its initial status. Make sure you make a note of the account information of each online service before you contact your local dealer or the nearest Epson repair center.

Parent topic: [Solving Problems](#)

Related references

[Where to Get Help \(U.S. and Canada\)](#)

[Where to Get Help \(Latin America\)](#)

[Projector Light Status](#)

Related tasks

[Turning Off the Projector](#)

[Cleaning the Projection Window](#)

[Cleaning the Air Filter and Vents](#)

Replacing the Air Filter

Projector Light Status

The light on the projector indicates the projector status and lets you know when a problem occurs. Check the status and color of the light and look for a solution in the table here.

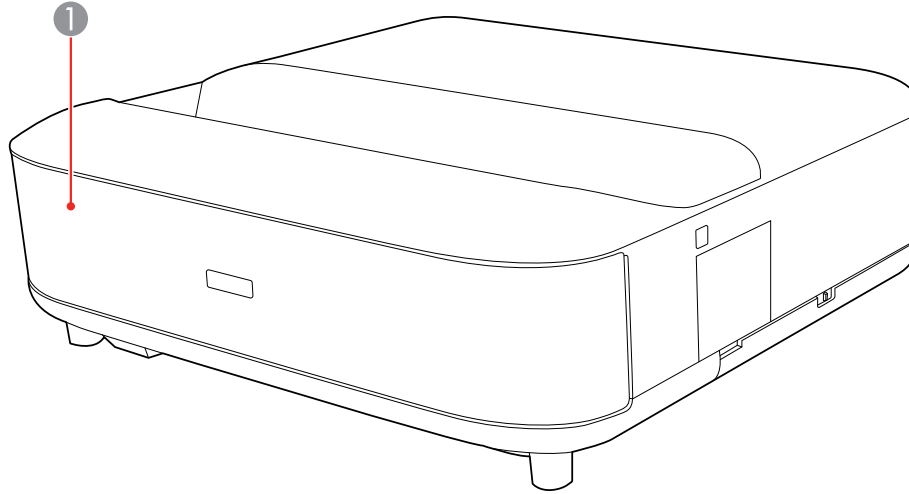

1 Status light

Status light	Status and solution
Blue	Normal operation.
Flashing blue	Warming up, shutting down, or initializing the projector. Remote control operations may be disabled when the light is flashing blue.
Off	Standby or sleep mode.

Status light	Status and solution
Orange	<p>Projector has overheated and turned off. Leave it turned off to cool down and wait about five minutes.</p> <ul style="list-style-type: none"> • Make sure that the vents and air filter are not clogged with dust or obstructed by nearby objects. • Make sure the environmental temperature is not too hot. • Clean or replace the air filter. • If operating the projector at high altitude, turn on High Altitude Mode. • If the problem persists, unplug the projector and contact Epson for help.
	<p>Movement detection warning. A beep sounds and a warning message is displayed. The brightness of the light source is reduced.</p> <ul style="list-style-type: none"> • Make sure that no one is looking into the projection window. Move away from the projection window. • Clean the motion sensor if there is no one near the projection window.
	<p>Laser warning. Turn the projector off, unplug it, and contact Epson for help.</p>
Flashing orange	<p>Laser has a problem. Turn the projector off, unplug it, and contact Epson for help.</p>
	<p>A fan or sensor has a problem. Turn the projector off, unplug it, and contact Epson for help.</p>
	<p>Obstacle detection error. If there are no obstacles interfering with the projection window, turn the projector off, unplug it, and contact Epson for help.</p>
	<p>Internal projector error. Turn the projector off, unplug it, and contact Epson for help.</p>

Parent topic: [Solving Problems](#)

Solving Image or Sound Problems

Check the solutions in these sections if you have any problems with projected images or sound.

[Solutions When No Image Appears](#)
[Solutions When "No Signal" Message Appears](#)
[Solutions When Only a Partial Image Appears](#)
[Solutions When the Image is Not Rectangular](#)
[Solutions When the Image Contains Noise or Static](#)
[Solutions When the Image is Flipped or Too Small](#)
[Solutions When the Image is Fuzzy or Blurry](#)
[Solutions When the Image Brightness or Colors are Incorrect](#)
[Solutions to Sound Problems](#)
[Solutions to Bluetooth Audio Problems](#)
Parent topic: [Solving Problems](#)

Solutions When No Image Appears

If no image appears, try the following solutions:

- Check the status light to confirm the projector is operating normally.
- Press the  blank button on the remote control to see if the image was temporarily turned off.
- Make sure all necessary cables are securely connected and the power is on for the projector and connected video sources.
- Try using a shorter HDMI cable.
- Try connecting the video source directly to the projector.
- Press the projector's power button to wake it from standby or sleep mode. Also see if your connected computer is in sleep mode or displaying a blank screen saver.
- If you are projecting from a streaming device, make sure it is powered by the USB power cable inside the projector. Turn on the connected streaming device or video source, and press the play button to start a video, if necessary.
- Make sure the connected device meets the HDMI CEC standard. See the documentation supplied with the device for more information. If necessary, set the CEC function for the connected device again and restart the device. Turn off the projector and the connected streaming device or video source, and then turn them back on.
- Turn off the projector and the connected streaming device or video source, and then turn them back on.
- If you are projecting from a laptop computer, make sure it is set up to display on an external monitor.

- Make sure the computer's display resolution does not exceed the projector's resolution and frequency limits. If necessary, select a different display resolution for your computer. (See your computer manual for details.)
- If you are trying to view online content, make sure you have an active Internet connection.
- Make sure you selected the correct **EDID** setting in the projector's Picture menu, if available for your image source.
- When sending 18 Gbps images such as 4K 60 Hz, use an HDMI cable (premium high-speed).
- If the other solutions do not solve the problem, reset all of the projector settings using the option in the **Settings** menu.

Parent topic: [Solving Image or Sound Problems](#)

Related references

[Projector Light Status](#)

[Projector Feature Settings - Settings Menu](#)

[Image Quality Settings - Picture Menu](#)

Related tasks

[Connecting to an HDMI Video Source](#)

Solutions When "No Signal" Message Appears

If the "No Signal" message appears, try the following solutions:

- Press the  Source Search button on the remote control and then select from the displayed sources. Wait a few seconds for an image to appear.
- Turn on the connected computer or video source, and press its play button to begin your presentation, if necessary.
- Check the connection from the projector to your video sources.
- If you are projecting from a laptop computer, make sure it is set up to display on an external monitor.
- If necessary, turn the projector and the connected computer or video source off and then on again.
- If you are projecting from an HDMI source, replace the HDMI cable with a shorter one.
- Connect the video source directly to the projector.
- Check that the source device is not sending a signal that has too high a bandwidth for the cable or the projector. Click the link below to see the supported video display formats.
- If the other solutions do not solve the problem, reset all of the projector settings using the option on the **Settings** menu.

[Displaying From a PC Laptop](#)

[Displaying From a Mac Laptop](#)

Parent topic: [Solving Image or Sound Problems](#)

Related concepts

[Projector Connections](#)

Related tasks

[Selecting an Image Source](#)

Displaying From a PC Laptop

If you see the "No Signal" message when you display from a PC laptop, you need to set up the laptop to display on an external monitor.

1. Hold down the laptop's **Fn** key and press the key labeled with a monitor icon or **CRT/LCD**. (See your laptop manual for details.) Wait a few seconds for an image to appear. To display on both the laptop's monitor and the projector, try pressing the same keys again.

Note: On Windows 7 or later, hold down the Windows key and press **P** at the same time, then click **Duplicate**.

2. If the same image is not displayed by the laptop and projector, check the Windows **Display** utility to make sure the external monitor port is enabled and extended desktop mode is disabled. (See your computer or Windows manual for instructions.)
3. If necessary, check your video card settings and set the multiple display option to **Clone**, **Mirror**, or **Duplicate**.

Parent topic: [Solutions When "No Signal" Message Appears](#)

Displaying From a Mac Laptop



If you see the "No Signal" message when you display from a Mac laptop, you need to set up the laptop for mirrored display. (See your laptop manual for details.)

1. Open the **System Preferences** utility and select **Displays**, **Display**, or **Color LCD**.
2. Click the **Arrange** or **Arrangement** tab.
3. Select the **Mirror Displays** checkbox.

Parent topic: [Solutions When "No Signal" Message Appears](#)

Solutions When Only a Partial Image Appears

If only a partial computer image appears, try the following solutions:

- If **Aspect Ratio** in the Picture menu is set to **Zoom**, change it to **Normal**.
- If you adjusted the size of the projected image, press the  Flexible Picture menu button on the remote control to display the Flexible Picture menu, and then press the  brightness up button until the projected image is the right size.
- Check your computer display settings to disable dual display and set the resolution within the projector's limits. (See your computer manual for details.)
- Check the resolution assigned to your presentation files to see if they are created for a different resolution than you are projecting in. (See your software help for details.)

Parent topic: [Solving Image or Sound Problems](#)

Related references

[Image Quality Settings - Picture Menu](#)

Related tasks

[Changing the Image Aspect Ratio](#)

Solutions When the Image is Not Rectangular

If the projected image is not evenly rectangular, try the following solutions:

- Place the projector directly in front of the center of the screen, facing it squarely, if possible.
- Correct the distortion in the projected image by pressing the  Corner Adjustment button on the remote control and following the on-screen instructions.

Parent topic: [Solving Image or Sound Problems](#)

Related concepts

[Projector Placement](#)

Solutions When the Image Contains Noise or Static

If the projected image seems to contain electronic interference (noise) or static, try the following solutions:

- Check the cables connecting your computer or video source to the projector. They should be:
 - Separated from the power cord to prevent interference
 - Securely connected at both ends

- Not connected to an extension cable
- Adjust the **Noise Reduction** setting in the projector's Picture menu.
- Select a computer video resolution and refresh rate that are compatible with the projector.
- If you adjusted the image shape using the projector controls, try decreasing the **Sharpness** setting in the Picture menu to improve image quality.
- Make sure you selected the correct **EDID** setting in the projector's Picture menu.
- If you connected an extension power cable, try projecting without it to see if it caused interference in the signal.

Parent topic: [Solving Image or Sound Problems](#)





Related references

[Image Quality Settings - Picture Menu](#)

[Supported Video Display Formats](#)

Solutions When the Image is Flipped or Too Small

If the projected image is flipped or too small, try the following solutions:

- If you flipped the projected image using the Reverse Flip Picture function, press the  Flexible Picture menu button on the remote control to display the Flexible Picture menu, and then press the  Flexible Picture menu button again to disable the function.
- If you adjusted the size of the projected image, press the  Flexible Picture menu button on the remote control to display the Flexible Picture menu, and then press the  brightness up button until the projected image is the right size.
- Make sure the projection orientation is correct in the projector's Settings menu.

Parent topic: [Solving Image or Sound Problems](#)



Solutions When the Image is Fuzzy or Blurry

If the projected image is fuzzy or blurry, try the following solutions:

- Adjust the image focus using the focus lever.
- Clean the projection window.

Note: To avoid condensation on the projection window after bringing the projector in from a cold environment, let the projector warm up to room temperature before using it.

- Position the projector close enough to the screen.

- Adjust the **Sharpness** setting to improve image quality.
- If you are projecting from a computer, use a lower resolution or adjust the computer's resolution to match the projector's native resolution, if possible.
- If you blurred the edges of the projected image using the Edge Blur function, press the  Flexible Picture menu button on the remote control to display the Flexible Picture menu, and then press the  blank button to disable the function.

Parent topic: [Solving Image or Sound Problems](#)

Related concepts

[Projector Placement](#)

Related references

[Image Quality Settings - Picture Menu](#)

[Supported Video Display Formats](#)

Related tasks

[Cleaning the Projection Window](#)

[Focusing the Image](#)

Solutions When the Image Brightness or Colors are Incorrect

If the projected image is too dark or light, or the colors are incorrect, try the following solutions:

- Try selecting a color mode that best fits the image and environment.
- Check your video source settings.
- Try adjusting the **Scene Adaptive Gamma, Custom Settings, Color Temperature, Frame Interpolation, Dynamic Contrast, Noise Reduction, Super-resolution, Auto Contrast Enhancement**, and **Aspect Ratio** settings in the Picture menu for the current input source.
- Make sure you selected the correct **HDMI Video Range, HDR**, or **EDID** settings in the Picture menu, if available for your image source. You can make the image brighter by setting **HDR** to a lower number.
- When you are projecting your image onto a wall, try different wall color types for the image and environment by selecting the **Adjust color** setting in the Installation menu.
- Make sure all the cables are securely connected to the projector and your video device. If you connected long cables, try connecting shorter cables.
- Position the projector close enough to the screen.

Parent topic: [Solving Image or Sound Problems](#)

Related references

[Image Quality Settings - Picture Menu](#)

Solutions to Sound Problems

If there is no sound when you expect it or the volume is too low or high, try the following solutions:

- Adjust the projector's volume settings.
- Check your computer or video source to make sure the volume is turned up and the audio output is set for the correct source.
- Check the cable connection between the projector and your video source.
- If you do not hear sound from an HDMI source, set the connected device to PCM output.
- If you want to output audio from the projector's speakers, check that the **Sound Output** setting is correct in the Sound menu.
- If you want to output audio to an external audio device using an HDMI cable, try the following solutions:
 - Make sure the HDMI cable is connected to the projector's **HDMI2 (eARC/ARC)** port
 - Make sure the sound is output from the projector's speakers or **Optical Out** port
 - Enable **HDMI CEC** in the Settings menu
 - Enable **HDMI2 ARC** in the Settings menu
 - Set **Sound Output** to **ARC (PCM)** in the Sound menu
 - Make sure the HDMI cable is compliant with HDMI ARC

Note: When outputting audio to an external audio device that does not support HDMI ARC using an HDMI cable, disable **HDMI CEC** in the Settings menu.

- If you want to output audio to an external audio device using an optical digital audio cable, check that the **Sound Output** setting is correct in the Sound menu.

Parent topic: [Solving Image or Sound Problems](#)

Related references

[Projector Feature Settings - Settings Menu](#)

[Sound Quality Settings - Sound Menu](#)

Solutions to Bluetooth Audio Problems

If you cannot connect to a Bluetooth audio device, try the following solutions:

- If you are trying to use the projector as a speaker, enable **Bluetooth Speaker Mode** in the projector's menu.
- Select **Projector** from the available Bluetooth device list displayed on your device.
- Make sure the Bluetooth audio device is paired to the projector and not to another device.
- Make sure only one Bluetooth device is connected to the projector. You cannot connect multiple Bluetooth audio devices to the projector at the same time.
- Make sure the device meets the projector's Bluetooth specifications.
- Make sure the volume level on the paired Bluetooth audio device and projector is turned up.
- Make sure there are no obstacles between the Bluetooth audio device and the projector and that the Bluetooth audio device is within the specified communication distance. Place the Bluetooth audio device closer to the projector to improve communication. Avoid using the projector near wireless networks, microwave ovens, 2.4 GHz cordless phones, or other devices that use the 2.4 GHz frequency band. These devices can interfere with the signal between the projector and the Bluetooth audio device.

Parent topic: [Solving Image or Sound Problems](#)

Related references

[Bluetooth Specifications](#)

Related tasks

[Using the Projector as a Bluetooth Speaker](#)

[Controlling the Volume with the Volume Buttons](#)

Solving Projector or Remote Control Operation Problems

Check the solutions in these sections if you have problems operating the projector or remote control.

Note: For Android TV support, visit <https://support.google.com/androidtv/>.

[Solutions to Projector Power or Shut-Off Problems](#)

[Solutions to Remote Control Problems](#)

[Solutions to HDMI Link Problems](#)

Parent topic: [Solving Problems](#)

Solutions to Projector Power or Shut-Off Problems

If the projector does not come on when you press the power button or it shuts off unexpectedly, try the following solutions:

- Make sure the power cord is securely connected to the projector and to a working electrical outlet.
- If the projector shuts off unexpectedly, it may have entered standby mode after a period of inactivity. Press the power button on the projector or remote control to wake the projector. After waking the projector, the **Sleep Timer** setting is automatically set to **Off**.
- If the projector's laser shuts off and the Status light is orange, the projector has overheated and shut off. Check the solutions for this light status.
- Turn off the **HDMI CEC** setting. If this resolves the issue, check the settings on connected devices and make sure the projector is not receiving shut down requests over CEC.
- If the power button on the remote control does not turn on the projector, check its batteries.
- The power cord may be defective. Try another power cord. If that doesn't work, disconnect the cord and contact Epson.
- The cooling fans may run in standby status depending on the projector settings. Also, when the projector wakes from standby status, the fans may cause an unexpected noise. This is not a malfunction.
- Make sure there are no obstacles interfering with the projection window. Remove any obstacles, if necessary.

Parent topic: [Solving Projector or Remote Control Operation Problems](#)

Related references

[Where to Get Help \(U.S. and Canada\)](#)

[Where to Get Help \(Latin America\)](#)

[Projector Light Status](#)

[Projector Feature Settings - Settings Menu](#)

[Image Quality Settings - Picture Menu](#)

Related tasks

[Cleaning the Motion Sensor](#)

Solutions to Remote Control Problems

If the projector does not respond to remote control commands, try the following solutions:

- Check that the remote control batteries are installed correctly and have power. If necessary, replace the batteries.

- Make sure you are operating the remote control within the reception angle and range of the projector.
- Make sure the projector is not warming up or shutting down.
- Check to see if a button on the remote control is stuck down, causing it to enter sleep mode. Release the button to wake the remote control up.
- Check the status indicator to confirm that the projector is in normal operating status.
- Make sure the remote control is paired to the projector to operate Android TV features. If the pairing screen is displayed, perform pairing again by holding down the **Enter** and **Home** buttons on the remote control simultaneously for about three seconds.
- Strong fluorescent lighting, direct sunlight, or infrared device signals may be interfering with the projector's remote receivers. Dim the lights or move the projector away from the sun or interfering equipment.
- If you lose the remote control, you can purchase another from an Epson parts distributor.

Parent topic: [Solving Projector or Remote Control Operation Problems](#)

Related references

[Projector Light Status](#)

[Remote Control Operation](#)

Related tasks

[Pairing the Remote Control](#)

[Replacing the Remote Control Batteries](#)

Solutions to HDMI Link Problems

If you cannot control an HDMI device using the HDMI Link feature, try the following solutions:

- Make sure all necessary cables are securely connected and the power is on for the projector and connected video sources.
- Make sure you connect the HDMI cable to the **HDMI2 (eARC/ARC)** port.
- Make sure the cables meet the HDMI CEC standard.
- Make sure the connected device meets the HDMI CEC standard. See the documentation supplied with the device for more information.
- Make sure the **HDMI CEC** setting is enabled.
- Make sure the connected devices are turned on and in standby status. See the documentation supplied with the device for more information.

- If you connected a new device or changed any connections, make sure the CEC function is set for the connected device. You may need to restart the device.

Parent topic: [Solving Projector or Remote Control Operation Problems](#)

Related references

[Projector Feature Settings - Settings Menu](#)

Solving Network Problems

Check the solutions in these sections if you have problems using the projector on a network.

[Solutions When Wireless Authentication Fails](#)

Parent topic: [Solving Problems](#)

Solutions When Wireless Authentication Fails

If you cannot authenticate a wireless connection, try the following solutions:

- Make sure your Wi-Fi router and modem are working properly. Rebooting these devices may solve the network connection problem.
- Check for obstacles between the Wi-Fi router and the projector and change their positions to improve communication.
- You can check the network settings from the menu displayed when you press the  Android TV settings button on the remote control.
- If you initialize the projector, you need to select the network settings again on the initial setup screen.

Parent topic: [Solving Network Problems](#)

Related tasks

[Setting Up Android TV](#)

Where to Get Help (U.S. and Canada)

If you need to contact Epson for technical support services, use the following support options.

Internet Support

Visit Epson's support website at epson.com/support (U.S.) or epson.ca/support (Canada) and select your product for solutions to common problems with your projector. You can download utilities and documentation, get FAQs and troubleshooting advice, or e-mail Epson with your questions.

Speak to a Support Representative

To use the Epson PrivateLine Support service, call (800) 637-7661. This service is available for the duration of your warranty period. You may also speak with a projector support specialist by dialing (562) 276-4394 (U.S.) or (905) 709-3839 (Canada).

Support hours are Monday through Friday, 7 a.m. to 4 p.m., Pacific Time.

Days and hours of support are subject to change without notice. Toll or long distance charges may apply.

Before you call, have the following information ready:

- Product name
- Product serial number (located on the bottom or rear of the projector, or in the menu system)
- Proof of purchase (such as a store receipt) and date of purchase
- Computer or video configuration
- Description of the problem

Purchase Supplies and Accessories

You can purchase screens, other optional accessories, and replacement parts from an Epson authorized reseller. To find the nearest reseller, call 800-GO-EPSON (800-463-7766) in the U.S. or 800-807-7766 in Canada. Or you can purchase online at epsonstore.com (U.S. sales) or epsonstore.ca (Canadian sales).

You can purchase a replacement remote control from an Epson parts distributor [here](#) (U.S. sales) or [here](#) (Canadian sales).

Parent topic: [Solving Problems](#)

Where to Get Help (Latin America)

If you need to contact Epson for technical support services, use the following support options.

Internet Support

Visit Epson's support website at latin.epson.com/support and select your product for solutions to common problems with your projector. You can download utilities and documentation, get FAQs and troubleshooting advice, or e-mail Epson with your questions.

Speak to a Support Representative

Before you call for support, please have the following information ready:

- Product name

- Product serial number (located on the bottom or rear of the projector, or in menu system)
- Proof of purchase (such as a store receipt) and date of purchase
- Computer or video configuration
- Description of the problem

Then call:

Country	Telephone
Argentina	(54 11) 5167-0300 0800-288-37766
Bolivia*	800-100-116
Brazil	0800-007-5000
Chile	(56 2) 2484-3400
Colombia	Bogota: (57 1) 602-4751 Other cities: 01-8000-915235
Costa Rica	800-377-6627
Dominican Republic*	1-888-760-0068
Ecuador*	1-800-000-044
El Salvador*	800-6570
Guatemala*	1-800-835-0358
Mexico	Mexico City: (52 55) 1323-2052 Other cities: 800-087-1080
Nicaragua*	00-1-800-226-0368
Panama*	00-800-052-1376
Paraguay	009-800-521-0019
Peru	Lima: (51 1) 418-0210 Other cities: 0800-10126
Uruguay	00040-5210067
Venezuela	(58 212) 240-1111

*Contact your local phone company to call this toll-free number from a mobile phone.

Note: Toll or long distance charges may apply. If your country does not appear on the list, contact the sales office in the nearest country.

Purchase Supplies and Accessories

You can purchase optional accessories and replacement parts from an Epson authorized reseller. To find the nearest reseller, go to latin.epson.com. Or you can contact your nearest sales office as described in "Where to Get Help."

Parent topic: [Solving Problems](#)

Technical Specifications

These sections list the technical specifications of your projector.

[General Projector Specifications](#)

[Projector Light Source Specifications](#)

[Remote Control Specifications](#)

[Projector Dimension Specifications](#)

[Projector Electrical Specifications](#)

[Bluetooth Specifications](#)

[Projector Environmental Specifications](#)

[Projector Safety and Approvals Specifications](#)

[Supported Video Display Formats](#)

General Projector Specifications

Type of display	Poly-silicon TFT active matrix
Resolution	1920 × 1080 pixels (Full HD)
Lens	F=1.6 Focal length: 3.7 mm
Color reproduction	Full color, up to 1.07 billion colors

Brightness	<p>Normal light source mode: White light output 3600 lumens (Dynamic color mode) Color light output 3600 lumens (Dynamic color mode)</p> <p>Medium light source mode: White light output 2000 lumens (Vivid color mode)</p> <p>ECO light source mode: White light output 1800 lumens (Dynamic color mode)</p> <p>Note: Color brightness (color light output) and white brightness (white light output) will vary depending on usage conditions. Color light output measured in accordance with IDMS 15.4; white light output measured in accordance with ISO 21118.</p>
Contrast ratio	Over 2,500,000 with Dynamic color mode and Normal light source mode
Image size (in native aspect ratio)	60 inches (32.5 cm) to 120 inches (70.3 cm)
Projection distance (in native aspect ratio)	12.8 inches (32.5 cm) to 27.7 inches (70.3 cm)
Focus adjustment	Manual
Projection methods	Front
Optical aspect ratio (width-to-height)	16:9
Focus adjustment	Manual
Internal sound system	2.1 channel (20 W total): 5 W x 2 (satellite), 10 W x 1 (woofer)
Fan noise level	36 dB (Normal power consumption) 29 dB (Medium power consumption) 23 dB (ECO power consumption)
USB Type A port compatibility	One USB 2.0 compliant port for connecting a flash drive, webcam, microphone, external HDD, or keyboard One port for providing power to a streaming media device (5 V, 2 A)

USB Type mini-B port compatibility

One USB 2.0 compliant port for firmware updates

Parent topic: [Technical Specifications](#)

Projector Light Source Specifications

Type	Laser diode
Light source output power	Up to 66 W
Wavelength	449 to 461 nm
Light source life (approximate)	Normal light source mode: Up to about 20000 hours Medium light source mode: Up to about 20000 hours ECO light source mode: Up to about 20000 hours

Note: Turn off this product when not in use to prolong the life of the projector. Laser life will vary depending upon mode selected, environmental conditions, and usage. Brightness decreases over time.

Parent topic: [Technical Specifications](#)

Remote Control Specifications

Reception range	19.7 feet (6 m)
Batteries	Two alkaline or manganese AAA

Parent topic: [Technical Specifications](#)

Projector Dimension Specifications

Height (excluding feet)	5.2 inches (133 mm)
Width	18.4 inches (467 mm)

Depth

15.7 inches (400 mm)

Weight

Approximately 16.31 lb (7.4 kg)

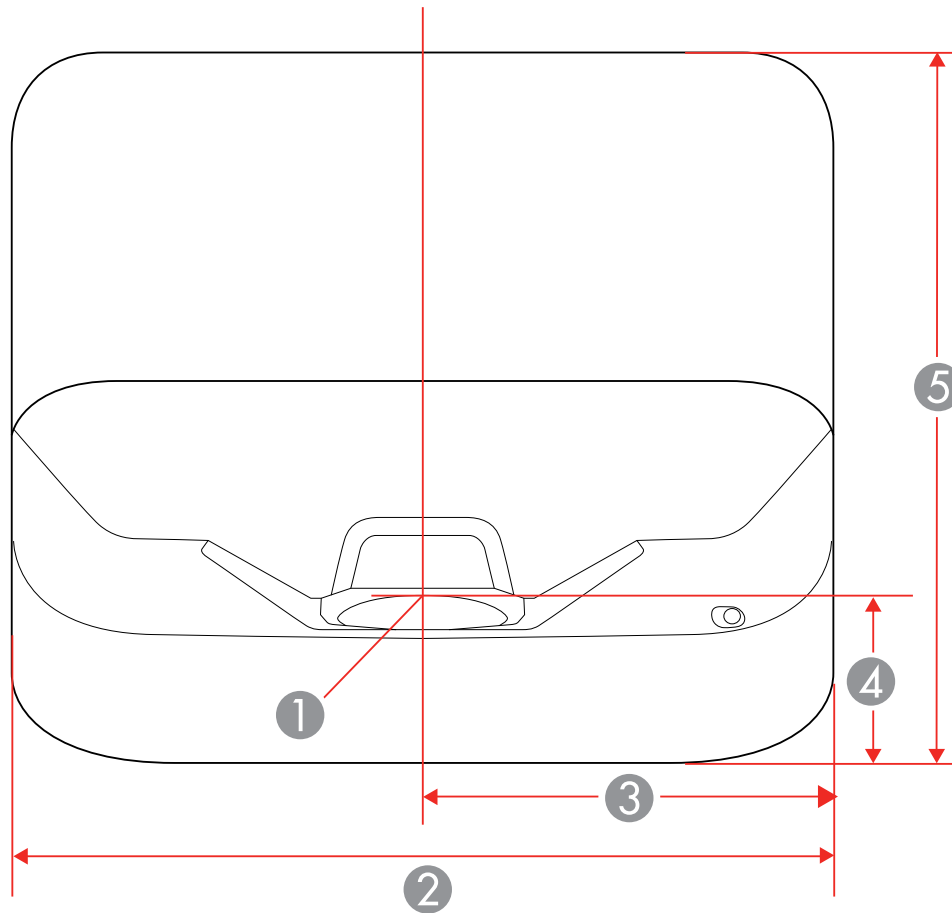

- 1 Center of projection window
- 2 18.4 inches (467 mm)
- 3 19.2 inches (233.5 mm)
- 4 3.6 inches (92.2 mm)

5

15.7 inches (400 mm)

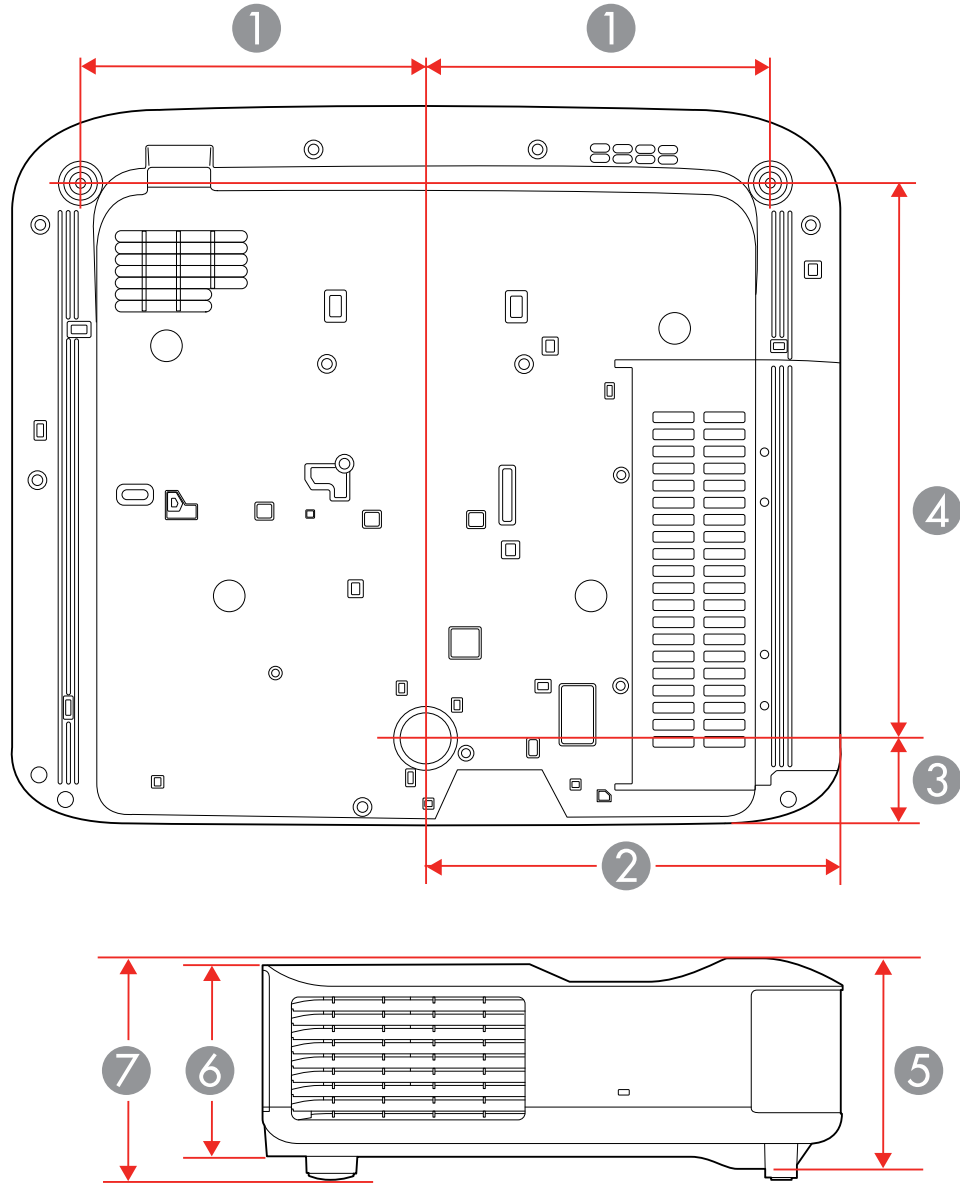

1	7.6 inches (193 mm)
2	19.2 inches (233.5 mm)
3	1.9 inches (47.5 mm)
4	12.2 inches (311 mm)
5	5.7 inches (146 mm)
6	5.2 inches (133 mm)
7	6 inches (153 mm)

Parent topic: [Technical Specifications](#)

Projector Electrical Specifications

Rated frequency	50/60 Hz
Power supply	100 to 240 V AC \pm 10% 2.8 to 1.3 A
Power consumption (100 to 120 V)	Operating: Normal power consumption mode: 278 W Medium power consumption mode: 244 W Quiet/Extended Power Consumption mode: 186 W Standby: 0.5 W (Communication Off), 2.0 W (Communication On)
Power consumption (220 to 240 V)	Operating: Normal power consumption mode: 264 W Medium power consumption mode: 234 W Quiet/Extended power consumption mode: 178 W Standby: 0.5 W (Communication Off), 2.0 W (Communication On)

Parent topic: [Technical Specifications](#)

Bluetooth Specifications

Version	Bluetooth Ver. 5.0
Output	Class 1
Communication distance	Approximately 32.8 feet (10 m)
Supported profiles	A2DP, AVRCP
Frequency used	2.4 GHz band (2.402 to 2.480 GHz)
Supported codecs	SBC

Caution: Do not use the device near any medical equipment or equipment that is automatically controlled, such as automatic doors or fire alarms. Electromagnetic interference from the device may cause such equipment to malfunction and cause an accident.

Note: You may not be able to connect depending on the standard and type of device. Even when connecting within the specified communication distance, connections can be lost due to the status of the signal. The communication method for Bluetooth uses the same frequency (2.4 GHz) as wireless LAN (IEEE802.11b/g/n) or microwave ovens. If these devices are used at the same time, radio wave interference may occur, the audio may be interrupted, or communication may not be possible. If you do need to use these devices at the same time, make sure there is enough distance between them and the Bluetooth device.

Parent topic: [Technical Specifications](#)

Projector Environmental Specifications

Temperature	Operating: Up to 7500 feet (2286 m): 41 to 95 °F (5 to 35 °C) 7500 feet (2286 m) to 10000 feet (3048 m): 41 to 86 °F (5 to 30 °C) Storage: 14 to 140 °F (–10 to 60 °C)
Humidity (relative, non-condensing)	Operating: 20 to 80% Storage: 10 to 90%
Operating altitude	Up to 4921 feet (1500 m) Up to 10000 feet (3048 m) with High Altitude Mode enabled

Parent topic: [Technical Specifications](#)

Projector Safety and Approvals Specifications

United States	FCC Part 15 Class B UL62368-1 2nd edition (cTUVus Mark)
Canada	ICES-003 Class B CSA C22.2 No. 62368-1-14 (cTUVus Mark)

Parent topic: [Technical Specifications](#)

Supported Video Display Formats

For best results, your computer's monitor port or video card resolution should be set to display in the projector's native resolution. However, your projector includes Epson's SizeWise chip that supports other computer display resolutions, so your image will be resized to fit automatically.

Your computer's monitor port or video card refresh rate (vertical frequency) must be compatible with the projector. (See your computer or video card manual for details.)

The table here lists the compatible refresh rate and resolution for each compatible video display format.

Display format	Refresh rate (in Hz)	Resolution (in pixels)
HDMI Input Signals		
PC	59.97	2560 × 1600
480p	59.94	720 × 480
576p	50	720 × 576
720p	50/59.94/60	1280 × 720
1080i	50/59.94/60	1920 × 1080
1080p	23.98/24/29.97/30/50/59.94/60	1920 × 1080
1080p	100/119.8/120	1920 × 1080
4K	23.98/24/25/29.97/30/50/59.94/60	3840 × 2160
4K (SMPTE)	23.98/24/25/29.97/30/50/59.94/60	4096 × 2160

Compatible HDR Signals

Compatible signals are converted for output as an HDR image. For example, a 4K 60 Hz 4:4:4 8-bit signal is converted to a 4:2:2 10-bit HDR signal.

Refresh rate (in Hz)	Resolution (in pixels)
23.98/24/29.97/30/50/59.94/60	1920 × 1080
23.98/24/25/29.97/30	3840 × 2160
23.98/24/25/29.97/30	4096 × 2160

Resolution	Chroma subsampling (pixel encoding)	Color depth: 24 bits (8-bits per pixel)	Color depth: 30 bits (10-bits per pixel)	Color depth: 36 bits (12-bits per pixel)
1920 × 1080p	4:4:4	SDR	HDR	HDR
	4:2:2	SDR	HDR	HDR
	4:2:0	—	—	—
3840 × 2160p 4096 × 2160p	4:4:4	SDR	—	—
	4:2:2	SDR	HDR	HDR
	4:2:0	—	—	—

Output Audio Format

You can output (pass-through) HDMI audio signals with eARC/ARC when using an HDMI cable (with Ethernet). The audio format is determined by the specifications of the connected AV system or external speakers such as a sound bar.

Output audio format		eARC	ARC
LPCM	2ch (Max 48kHz/24bit)	Supported	Supported
Dolby	Dolby Digital (AC-3)	Supported	Supported
	Dolby Digital Plus	Supported	Supported
	Dolby TrueHD	—	—
	Dolby Atmos	Supported	—

Output audio format		eARC	ARC
DTS	DTS	Supported	Supported
	DTS-HD High Resolution Audio	—	—
	DTS-HD Master Audio	—	—
	DTS:X	—	—
AAC	—	—	—

Parent topic: [Technical Specifications](#)

Notices

Check these sections for important notices about your projector.

[Recycling \(U.S. and Canada\)](#)

[Important Safety Information](#)

[Laser Safety Information](#)

[Important Safety Instructions](#)

[List of Safety Symbols](#)

[FCC Compliance Statement](#)

[Binding Arbitration and Class Waiver](#)

[Trademarks](#)

[Copyright Notice](#)

Recycling (U.S. and Canada)

Epson offers a recycling program for end of life products. Please go to [this site](#) for information on how to return your products for proper disposal.

Parent topic: [Notices](#)

Important Safety Information

Caution: Never look into the projector lens when the laser is turned on; the bright light can damage your eyes. Never let children look into the lens when it is on. Never open the projector case. Dangerous electrical voltages inside the projector can severely injure you. Except as specifically explained in this *User's Guide*, do not attempt to service this product yourself. Refer all servicing to qualified service personnel.

Warning: The projector and its accessories come packaged in plastic bags. Keep plastic bags away from small children to avoid any risk of suffocation.

Parent topic: [Notices](#)

Laser Safety Information

This projector is a Class 1 laser product that complies with the IEC60825-1:2014 and EN60825-1:2014 + A11:2021 international standard for lasers. Follow these safety instructions when using the projector.

Warning: Possibly hazardous optical radiation emitted from this product. Do not look at operating light source. Eye injury may result.

- If an error occurs in the projector, turn off the power and unplug the projector immediately. Continuing to use the projector could result in an electric shock, fire, or visual impairment. Contact Epson support.
- Do not attempt to disassemble or modify the projector. The projector contains a high-power laser component. Serious injury could result.
- Do not look into the lens or projection window during projection. Also, do not look into the lens or projection window using optical devices, such as a magnifying glass or telescope. This could cause visual impairment.
- Do not place objects or put your hand near the projection window. It could cause burns, fire, or the object to warp because this area reaches a high temperature due to the concentrated projection light.
- When turning on the projector at a distance using the remote control, make sure no one is looking into the lens.
- Do not allow small children to operate the projector. Children must be accompanied by an adult.
- Do not apply optical devices, such as a magnifying glass or reflector, to the projected image. Using the projector may result in physical harm, fire, or an accident.
- Do not block the light from the lens during projection. The high temperature in this area could cause burns, fire, or other damage. The lens may overheat due to the reflected light and could cause the projector to malfunction.
- Before using the projector, make sure there is nothing in the area that could reflect the projected image.
- When disposing of the projector, do not disassemble it. Dispose of the projector in accordance with your local or national laws and regulations.

Laser warning labels are attached to the projector.

- **Inside**



- **Top**

As with any bright source, do not stare into the beam (RG2 IEC/EN 62471-5:2015).

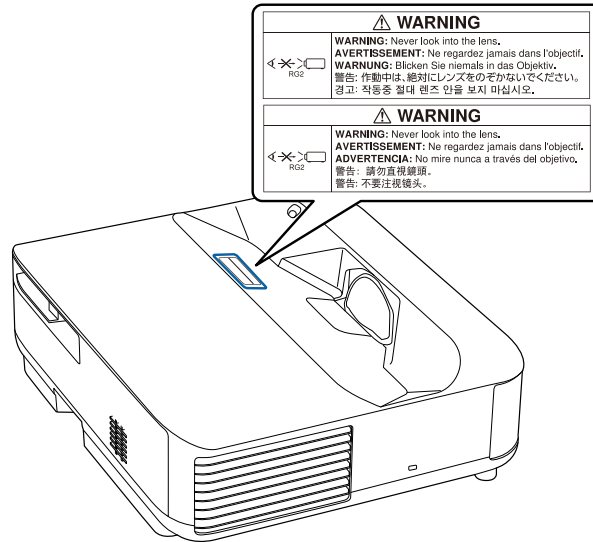

- **Bottom**

The label attached on the projector varies depending on the countries and regions.

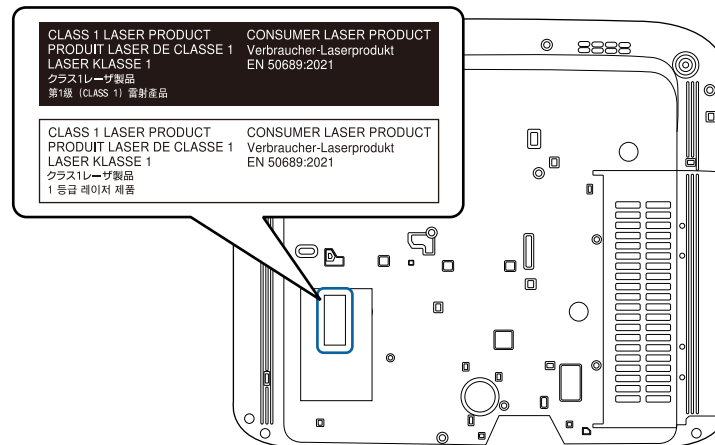

Complies with FDA performance standards for laser products except for conformance as a Risk Group 2 LIP as defined in IEC 62471-5: Ed. 1.0. For more information see Laser Notice No. 57, dated May 8, 2019.

Parent topic: [Notices](#)

Important Safety Instructions

Follow these safety instructions when setting up and using the projector:

- Do not look into the lens when the projector is on. The bright light can damage your eyes. Avoid standing in front of the projector so you do not block the projected image and the bright light does not shine into your eyes. Be especially careful if children are around. Do not look into the lens using a magnifying glass or telescope.
- Do not mount the projector on a ceiling or wall.
- Do not install or place the projector vertically. Doing so may cause a malfunction.
- When turning on the projector at a distance using the remote control, make sure there is no one looking into the lens.
- Do not place the projector on an unstable cart, stand, or table or on a surface that is unable to support its weight. Otherwise, it could fall or topple causing an accident and injury.
- Route any cords or cables so that they are out of the way; otherwise people may trip and fall or injure themselves.
- Do not operate the projector on its side, or while tilted to one side.
- When installing the projector in a high position, take measures to prevent it from falling by using wires to ensure safety in an emergency, such as an earthquake, and to prevent accidents. If the projector is not installed correctly, the projector could fall. This may result in injury or accidents. Contact your dealer to carry out the installation work.
- Do not install in locations where salt damage could occur, or in locations subject to corrosive gas such as sulphuric gas from hot springs. Otherwise, corrosion could cause the projector to fall. It could also cause the projector to malfunction.
- Do not install the projector in locations exposed to high humidity and dust, such as on a kitchen counter, in the kitchen, or near a humidifier, or in locations exposed to oil smoke or steam. Doing so could cause fire or electric shock.
- Do not use the projector near water, sources of heat, high-voltage electrical wires, or sources of magnetic fields.

- Do not use the device near any medical equipment or equipment that is automatically controlled, such as automatic doors or fire alarms. Electromagnetic interference from the device may cause such equipment to malfunction and cause an accident.
- Use the type of power source indicated on the projector. Use of a different power source may result in fire or electric shock. If you are not sure of the power available, consult your dealer or power company.
- Place the projector near a wall outlet where the plug can be easily unplugged.
- Take the following precautions when handling the plug: Do not hold the plug with wet hands. Do not insert the plug into a dusty outlet. Insert the plug firmly into the outlet. Do not pull the power cord when disconnecting the plug; always be sure to hold the plug when disconnecting it. Do not overload wall outlets, extension cords, or power strips. Failure to comply with these precautions could result in fire or electric shock.
- Do not place the projector where the cord can be walked on. This may result in fraying or damage to the plug.
- Unplug the projector from the wall outlet and allow to cool before cleaning. This avoids electric shock during cleaning. Use a dry cloth (or, for stubborn dirt or stains, a moist cloth that has been wrung dry) for cleaning. Do not use liquid or aerosol cleaners, any sprays containing flammable gas, or solvents such as alcohol, paint thinner, or benzene.
- Do not block the slots and openings in the projector case. They provide ventilation and prevent the projector from overheating. If the vents are covered, the internal temperature could rise and cause a fire. Do not place the projector in locations subject to high temperatures, such as near heating equipment. Do not operate the projector on a sofa, rug, or other soft surface, or set it on top of loose papers. Do not cover the projector with a blanket, curtain, or tablecloth. If you are setting up the projector near a wall, leave at least 11.8 inches (30 cm) of space between the wall and the projector. On the side where hot air is exhausted from the projector, leave at least 11.8 inches (30 cm) of space between the wall and the projector.
- Do not operate the projector in a closed-in cabinet unless proper ventilation is provided.
- Do not cover the projector's air intake or air exhaust vents. If the vents are covered, the internal temperature could rise and cause a fire.
- Never allow objects of any kind to enter any openings in the projector. Do not leave objects, especially flammable objects, near the projector. Never spill liquid of any kind into the projector.
- You may need to clean the air filter and vent. A clogged air filter or vent can block ventilation needed to cool the projector. Do not use canned air, or the gases may leave a residue.
- Do not use or store the projector in locations where it will be subject to dust or dirt. Otherwise, the quality of the projected image may decline, or the air filter may become clogged, resulting in a malfunction or fire.

- Follow the maintenance schedule for this projector. If the interior of the projector has not been cleaned for a long time, dust may build up, which could cause the internal temperature of the projector to rise, resulting in malfunctions, early deterioration of optical parts, and even fire or electric shock. Replace your air filter periodically and contact your dealer to clean the interior of the projector, as needed.
- Do not store the projector outdoors for an extended length of time.
- Except as specifically explained in this manual, do not attempt to service this product yourself. Refer all servicing to qualified personnel. Opening or removing covers may expose you to dangerous voltages and other hazards.
- Never open any covers on the projector except as specifically explained in this manual. Never attempt to disassemble or modify the projector. Refer all repairs to qualified service personnel.
- Unplug the projector from the wall outlet and refer servicing to qualified service personnel under the following conditions: if it does not operate normally when you follow the operating instructions, or exhibits a distinct change in performance; if smoke, strange odors, or strange noises come from the projector; if the power cord or plug is damaged or frayed; if liquid or foreign objects get inside the projector, or if it has been exposed to rain or water; if it has been dropped or the housing has been damaged. Continuing to use the projector under these conditions may result in fire, electric shock, or even damage to your eyesight. Do not try to repair this projector yourself. Place the projector near an easily accessible outlet so that the plug can be unplugged immediately when an error occurs.
- Do not touch the plug during an electrical storm. Otherwise, you may receive an electric shock.
- Unplug the projector when it will not be used for extended periods. The insulation may deteriorate, which may result in fire.
- Do not use the projector where it may be exposed to rain, water, or excessive humidity. Fire or electric shock may result.
- Do not install the projector in locations where it may be subject to salt damage or corrosive gas. Doing so may result in malfunction and the corrosion may cause the projector to fall.
- Do not use or store the projector where it may be exposed to smoke, steam, corrosive gases, excessive dust, vibration, or shock.
- Do not use or store the projector in places where smoke from oil or cigarettes may be present, as it can adversely affect the quality of the projected images.
- Do not use the projector where flammable or explosive gases may be present.
- Do not use or store the projector or remote control in a hot location, such as near a heater, in direct sunlight, or in a closed vehicle.
- If you use the projector in a country other than where you purchased it, use the correct power cord for that country.

- Do not stand on the projector or place heavy objects on it. You may fall over, resulting in injury and damage to the projector.
- If you are using the projector at altitudes above 4,921 feet (1,500 m), enable the **High Altitude Mode** setting in the projector's menu to ensure the projector's internal temperature is regulated properly.
- Do not use the projector outside of the required temperature range below (20 to 80% humidity, no condensation):
 Doing so may cause an unstable display and could lead to projector damage. Do not use or store the projector where it may be exposed to sudden changes in temperature.
- Do not store the projector outside of the required temperature range of 14 to 140 °F (–10 to 60 °C) or in direct sunlight for long periods of time. Doing so may cause damage to the case.
- Store the projector in a dry location.
- Do not place anything that can become warped or damaged by heat near the exhaust vents. Do not bring your hands or face close to the vents while projection is in progress. Do not bring your face close to the projector while it is in use. Hot air from the exhaust vents could cause burns, warping, or other damage to property.
- Before you move the projector, make sure its power is turned off, the plug is disconnected from the outlet, and all cables are disconnected. Fire or electric shock may result.
- Do not place the source of an open flame, such as a lit candle, on or near the projector.
- During projection, do not block the light from the projector with a book or other objects. If the light from the projector is blocked, the area on which the light shines becomes hot which could cause it to melt, burn, or start a fire. Also, the lens may get hot due to the reflected light which could cause the projector to malfunction. To stop projection, use the Blank function, or turn off the projector.
- Do not modify the power cord. Do not place heavy objects on top of the power cord or bend, twist, or pull it excessively. Keep the power cord away from hot electrical appliances. Do not tie the power cord to other cables.
- Incorrect battery usage may cause leakage of battery fluid and battery rupture, which could result in fire, injury, or corrosion. When replacing batteries, take the following precautions: insert batteries so that the polarities (+ and -) are correct; do not use batteries of different types or mix old and new batteries; do not use any batteries other than those specified in this manual; if batteries leak, wipe away battery fluid with a soft cloth and replace them with new batteries; if battery fluid gets on your hands, wash them immediately; replace the batteries as soon as they run out; remove the batteries if you will not be using the projector for a long period of time; do not expose batteries to heat or flame and do not put them in water; dispose of used batteries according to local regulations; keep batteries out of the reach of children. Batteries are choking hazards and are very dangerous if swallowed. If a battery is swallowed, seek medical attention immediately.

- Remove the batteries from the remote control before storing the projector. If the batteries are left in the remote control for long periods, they may leak.
- Do not disassemble the projector when disposing of it. Dispose of the projector according to your local or national laws and regulations.

[Restriction of Use](#)

Parent topic: [Notices](#)

Restriction of Use



When this product is used for applications requiring high reliability/safety such as transportation devices related to aviation, rail, marine, automotive; disaster prevention devices; various safety devices; or functional/precision devices, you should use this product only after giving consideration to including fail-safes and redundancies into your design to maintain safety and total system reliability.







Because this product was not intended for use in applications requiring extremely high reliability/safety such as aerospace equipment, main communication equipment, nuclear power control equipment, or medical equipment related to direct medical care, please make your own judgment on this product's suitability after a full evaluation.







Parent topic: [Important Safety Instructions](#)







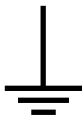

List of Safety Symbols







The following table lists the meaning of the safety symbols labeled on the equipment.

Symbol	Approved Standards	Description
	IEC60417 No. 5007	"ON" (power) To indicate connection to the mains.
	IEC60417 No. 5008	"OFF" (power) To indicate disconnection from the mains.

Symbol	Approved Standards	Description
	IEC60417 No. 5009	Stand-by To identify the switch or switch position by means of which part of the equipment is switched on in order to bring it into the stand-by condition.
	ISO7000 No. 0434B, IEC3864-B3.1	Caution To identify general caution when using the product.
	IEC60417 No. 5041	Caution, hot surface To indicate that the marked item can be hot and should not be touched without taking care.
	IEC60417 No. 6042 ISO3864-B3.6	Caution, risk of electric shock To identify equipment that has risk of electric shock.
	IEC60417 No. 5957	For indoor use only To identify electrical equipment designed primarily for indoor use.
	IEC60417 No. 5926	Polarity of DC power connector To identify the positive and negative connections (the polarity) on a piece of equipment to which a DC power supply may be connected.
	—	Polarity of DC power connector To identify the positive and negative connections (the polarity) on a piece of equipment to which a DC. power supply may be connected.

Symbol	Approved Standards	Description
	IEC60417 No. 5001B	Battery, general On battery powered equipment. To identify a device for instance a cover for the battery compartment, or the connector terminals.
	IEC60417 No. 5002	Positioning of cell To identify the battery holder itself and to identify the positioning of the cell(s) inside the battery holder.
	—	Positioning of cell To identify the battery holder itself and to identify the positioning of the cell(s) inside the battery holder.
	IEC60417 No. 5019	Protective earth To identify any terminal which is intended for connection to an external conductor for protection against electric shock in case of a fault, or the terminal of a protective earth electrode.
	IEC60417 No. 5017	Earth To identify an earth (ground) terminal in cases where neither the symbol No.13 is explicitly required.
	IEC60417 No. 5032	Alternating current To indicate on the rating plate that the equipment is suitable for alternating current only; to identify relevant terminals.
	IEC60417 No. 5031	Direct current To indicate on the rating plate that the equipment is suitable for direct current only; to identify relevant terminals.

Symbol	Approved Standards	Description
	IEC60417 No. 5172	Class II equipment To identify equipment meeting the safety requirements specified for Class II equipment according to IEC 61140.
	ISO 3864	General prohibition To identify actions or operations that are prohibited.
	ISO 3864	Contact prohibition To indicate injury that could occur due to touching a specific part of the equipment.
	—	Never look into the projector lens while the projector is on.
	—	To indicate that the marked item don't place anything on projector.
	ISO3864 IEC60825-1	Caution, laser radiation To indicate the equipment has a laser radiation part.
	ISO 3864	Disassembly prohibition To indicate a risk of injury, such as electric shock, if the equipment is disassembled.
	IEC60417 No. 5266	Standby, partial standby To indicate that part of the equipment is in the ready status.

Symbol	Approved Standards	Description
	ISO3864 IEC60417 No. 5057	Caution, movable parts To indicate that you must keep away from movable parts according to protection standards.
	IEC 60417 No. 6056	Caution (movable fan blades) To indicate that you must keep away from movable parts according to protection standards.
	IEC 60417 No. 6043	Caution (sharp corners) To indicate that you must not touch the sharp corners of the product according to protection standards.
	—	Never look into the projection lens while the projector is on.
	ISO7010 No. W027 ISO 3864	Warning, light emission (UV, visible light, IR and so on) To indicate that you must be careful not to injure your eyes or skin when near light emitting sections.
	IEC60417 No. 5109	Not to be used in residential areas To indicate that the electrical equipment/device is not suitable for use in residential area.

Parent topic: [Notices](#)

FCC Compliance Statement

For United States Users

This device complies with part 15 of the FCC Rules. Operation is subject to the following two conditions: (1) This device may not cause harmful interference, and (2) this device must accept any interference received, including interference that may cause undesired operation.

This equipment has been tested and found to comply with the limits for a Class B digital device, pursuant to Part 15 of the FCC Rules. These limits are designed to provide reasonable protection against harmful interference in a residential installation. This equipment generates, uses, and can radiate radio frequency energy and, if not installed and used in accordance with the instructions, may cause harmful interference to radio communications. However, there is no guarantee that interference will not occur in a particular installation. If this equipment does cause interference to radio and television reception, which can be determined by turning the equipment off and on, the user is encouraged to try to correct the interference by one or more of the following measures:

- Reorient or relocate the receiving antenna.
- Increase the separation between the equipment and receiver.
- Connect the equipment into an outlet on a circuit different from that to which the receiver is connected.
- Consult the dealer or an experienced radio/TV technician for help.

WARNING

The connection of a non-shielded equipment interface cable to this equipment will invalidate the FCC Certification or Declaration of this device and may cause interference levels which exceed the limits established by the FCC for this equipment. It is the responsibility of the user to obtain and use a shielded equipment interface cable with this device. If this equipment has more than one interface connector, do not leave cables connected to unused interfaces. Changes or modifications not expressly approved by the manufacturer could void the user's authority to operate the equipment.

For Canadian Users

CAN ICES-003(B)/NMB-003(B)

Parent topic: [Notices](#)

Binding Arbitration and Class Waiver

1. DISPUTES, BINDING INDIVIDUAL ARBITRATION, AND WAIVER OF CLASS ACTIONS AND CLASS ARBITRATIONS

1.1 Disputes. The terms of this Section 1 shall apply to all Disputes between you and Epson. The term "Dispute" is meant to have the broadest meaning permissible under law and includes any dispute, claim, controversy or action between you and Epson arising out of or relating to this Agreement, Epson branded products (hardware and including any related software), or other transaction involving you and Epson, whether in contract, warranty, misrepresentation, fraud, tort, intentional tort, statute, regulation, ordinance, or any other legal or equitable basis. "DISPUTE" DOES NOT INCLUDE IP CLAIMS, or more specifically, a claim or cause of action for (a) trademark infringement or dilution, (b) patent infringement, (c) copyright infringement or misuse, or (d) trade secret misappropriation (an "IP Claim"). You and Epson

also agree, notwithstanding Section 1.6, that a court, not an arbitrator, may decide if a claim or cause of action is for an IP Claim.

1.2 Binding Arbitration. You and Epson agree that all Disputes shall be resolved by binding arbitration according to this Agreement. **ARBITRATION MEANS THAT YOU WAIVE YOUR RIGHT TO A JUDGE OR JURY IN A COURT PROCEEDING AND YOUR GROUNDS FOR APPEAL ARE LIMITED.**

Pursuant to this Agreement, binding arbitration shall be administered by JAMS, a nationally recognized arbitration authority, pursuant to its code of procedures then in effect for consumer related disputes, but excluding any rules that permit joinder or class actions in arbitration (for more detail on procedure, see Section 1.6 below). You and Epson understand and agree that (a) the Federal Arbitration Act (9 U.S.C. §1, et seq.) governs the interpretation and enforcement of this Section 1, (b) this Agreement memorializes a transaction in interstate commerce, and (c) this Section 1 shall survive termination of this Agreement.

1.3 Pre-Arbitration Steps and Notice. Before submitting a claim for arbitration, you and Epson agree to try, for sixty (60) days, to resolve any Dispute informally. If Epson and you do not reach an agreement to resolve the Dispute within the sixty (60) days, you or Epson may commence an arbitration. Notice to Epson must be addressed to: Epson America, Inc., ATTN: Legal Department, 3131 Katella Ave., Los Alamitos, CA 90720 (the "Epson Address"). The Dispute Notice to you will be sent to the most recent address Epson has in its records for you. For this reason, it is important to notify us if your address changes by emailing us at EAlegal@ea.epson.com or writing us at the Epson Address above. Notice of the Dispute shall include the sender's name, address and contact information, the facts giving rise to the Dispute, and the relief requested (the "Dispute Notice"). Following receipt of the Dispute Notice, Epson and you agree to act in good faith to resolve the Dispute before commencing arbitration.

1.4 Small Claims Court. Notwithstanding the foregoing, you may bring an individual action in the small claims court of your state or municipality if the action is within that court's jurisdiction and is pending only in that court.

1.5 WAIVER OF CLASS ACTIONS AND CLASS ARBITRATIONS. YOU AND EPSON AGREE THAT EACH PARTY MAY BRING DISPUTES AGAINST THE OTHER PARTY ONLY IN AN INDIVIDUAL CAPACITY, AND NOT AS A PLAINTIFF OR CLASS MEMBER IN ANY CLASS OR REPRESENTATIVE PROCEEDING, INCLUDING WITHOUT LIMITATION FEDERAL OR STATE CLASS ACTIONS, OR CLASS ARBITRATIONS. CLASS ACTION LAWSUITS, CLASS-WIDE ARBITRATIONS, PRIVATE ATTORNEY-GENERAL ACTIONS, AND ANY OTHER PROCEEDING WHERE SOMEONE ACTS IN A REPRESENTATIVE CAPACITY ARE NOT ALLOWED. ACCORDINGLY, UNDER THE ARBITRATION PROCEDURES OUTLINED IN THIS SECTION, AN ARBITRATOR SHALL NOT COMBINE OR CONSOLIDATE MORE THAN ONE PARTY'S CLAIMS WITHOUT THE WRITTEN CONSENT OF ALL AFFECTED PARTIES TO AN ARBITRATION PROCEEDING.

1.6 Arbitration Procedure. If you or Epson commences arbitration, the arbitration shall be governed by the rules of JAMS that are in effect when the arbitration is filed, excluding any rules that permit arbitration on a class or representative basis (the "JAMS Rules"), available at <http://www.jamsadr.com> or by calling

1-800-352-5267 (U.S. or Canada), or <https://www.jamsadr.com/about/> or by calling +1-949-224-1810 (Latin America), and under the rules set forth in this Agreement. All Disputes shall be resolved by a single neutral arbitrator, and both parties shall have a reasonable opportunity to participate in the selection of the arbitrator. The arbitrator is bound by the terms of this Agreement. The arbitrator, and not any federal, state or local court or agency, shall have exclusive authority to resolve all disputes arising out of or relating to the interpretation, applicability, enforceability or formation of this Agreement, including any claim that all or any part of this Agreement is void or voidable. Notwithstanding this broad delegation of authority to the arbitrator, a court may determine the limited question of whether a claim or cause of action is for an IP Claim, which is excluded from the definition of "Disputes" in Section 1.1 above. The arbitrator shall be empowered to grant whatever relief would be available in a court under law or in equity. The arbitrator may award you the same damages as a court could, and may award declaratory or injunctive relief only in favor of the individual party seeking relief and only to the extent necessary to provide relief warranted by that party's individual claim. In some instances, the costs of arbitration can exceed the costs of litigation and the right to discovery may be more limited in arbitration than in court. The arbitrator's award is binding and may be entered as a judgment in any court of competent jurisdiction.

You may choose to engage in arbitration hearings by telephone. Arbitration hearings not conducted by telephone shall take place in a location reasonably accessible from your primary residence, or in Orange County, California, at your option.

a) Initiation of Arbitration Proceeding. If either you or Epson decides to arbitrate a Dispute, both parties agree to the following procedure:

(i) Write a Demand for Arbitration. The demand must include a description of the Dispute and the amount of damages sought to be recovered. You can find a copy of a Demand for Arbitration at <http://www.jamsadr.com> ("Demand for Arbitration").

(ii) Send three copies of the Demand for Arbitration, plus the appropriate filing fee, to: JAMS, 500 North State College Blvd., Suite 600 Orange, CA 92868, U.S.A.

(iii) Send one copy of the Demand for Arbitration to the other party (same address as the Dispute Notice), or as otherwise agreed by the parties.

b) Hearing Format. During the arbitration, the amount of any settlement offer made shall not be disclosed to the arbitrator until after the arbitrator determines the amount, if any, to which you or Epson is entitled. The discovery or exchange of non-privileged information relevant to the Dispute may be allowed during the arbitration.

c) Arbitration Fees. Epson shall pay, or (if applicable) reimburse you for, all JAMS filings and arbitrator fees for any arbitration commenced (by you or Epson) pursuant to provisions of this Agreement.

d) Award in Your Favor. For Disputes in which you or Epson seeks \$75,000 or less in damages exclusive of attorney's fees and costs, if the arbitrator's decision results in an award to you in an amount greater than Epson's last written offer, if any, to settle the Dispute, Epson will: (i) pay you \$1,000 or the amount

of the award, whichever is greater; (ii) pay you twice the amount of your reasonable attorney's fees, if any; and (iii) reimburse you for any expenses (including expert witness fees and costs) that your attorney reasonably accrues for investigating, preparing, and pursuing the Dispute in arbitration. Except as agreed upon by you and Epson in writing, the arbitrator shall determine the amount of fees, costs, and expenses to be paid by Epson pursuant to this Section 1.6d).

e) Attorney's Fees. Epson will not seek its attorney's fees and expenses for any arbitration commenced involving a Dispute under this Agreement. Your right to attorney's fees and expenses under Section 1.6d) above does not limit your rights to attorney's fees and expenses under applicable law; notwithstanding the foregoing, the arbitrator may not award duplicative awards of attorney's fees and expenses.

1.7 Opt-out. You may elect to opt-out (exclude yourself) from the final, binding, individual arbitration procedure and waiver of class and representative proceedings specified in this Agreement by sending a written letter to the Epson Address within thirty (30) days of your assent to this Agreement (including without limitation the purchase, download, installation of the Software or other applicable use of Epson Hardware, products and services) that specifies (i) your name, (ii) your mailing address, and (iii) your request to be excluded from the final, binding individual arbitration procedure and waiver of class and representative proceedings specified in this Section 1. In the event that you opt-out consistent with the procedure set forth above, all other terms shall continue to apply, including the requirement to provide notice prior to litigation.

1.8 Amendments to Section 1. Notwithstanding any provision in this Agreement to the contrary, you and Epson agree that if Epson makes any future amendments to the dispute resolution procedure and class action waiver provisions (other than a change to Epson's address) in this Agreement, Epson will obtain your affirmative assent to the applicable amendment. If you do not affirmatively assent to the applicable amendment, you are agreeing that you will arbitrate any Dispute between the parties in accordance with the language of this Section 1 (or resolve disputes as provided for in Section 1.7, if you timely elected to opt-out when you first assented to this Agreement).

1.9 Severability. If any provision in this Section 1 is found to be unenforceable, that provision shall be severed with the remainder of this Agreement remaining in full force and effect. **The foregoing shall not apply to the prohibition against class or representative actions as provided in Section 1.5. This means that if Section 1.5 is found to be unenforceable, the entire Section 1 (but only Section 1) shall be null and void.**

Parent topic: [Notices](#)

Trademarks

EPSON® is a registered trademark and the EPSON logo is a registered logomark of Seiko Epson Corporation.

PrivateLine® is a registered trademark and SizeWise™ is a trademark of Epson America, Inc.

Windows is a registered trademark of Microsoft Corporation in the United States and/or other countries.

Mac, macOS, and OS X are trademarks of Apple Inc., registered in the U.S. and other countries.

Google® is a registered trademark and Android™, Android TV™, Chromecast™ and Chromecast built-in™ are trademarks of Google LLC.

Google Assistant is not available in certain languages and countries. Availability of services varies by country and language.

General Notice: Other product names used herein are for identification purposes only and may be trademarks of their respective owners. Epson disclaims any and all rights in those marks.

EPSON®

Parent topic: [Notices](#)

Copyright Notice

All rights reserved. No part of this publication may be reproduced, stored in a retrieval system, or transmitted in any form or by any means, electronic, mechanical, photocopying, recording, or otherwise, without the prior written permission of Seiko Epson Corporation. The information contained herein is designed only for use with this Epson product. Epson is not responsible for any use of this information as applied to other products.

Neither Seiko Epson Corporation nor its affiliates shall be liable to the purchaser of this product or third parties for damages, losses, costs, or expenses incurred by purchaser or third parties as a result of: accident, misuse, or abuse of this product or unauthorized modifications, repairs, or alterations to this product, or (excluding the U.S.) failure to strictly comply with Seiko Epson Corporation's operating and maintenance instructions.

Seiko Epson Corporation shall not be liable for any damages or problems arising from the use of any options or any consumable products other than those designated as Original Epson Products or Epson Approved Products by Seiko Epson Corporation.

This information is subject to change without notice.

[A Note Concerning Responsible Use of Copyrighted Materials](#)

[Copyright Attribution](#)

Parent topic: [Notices](#)

A Note Concerning Responsible Use of Copyrighted Materials

Epson encourages each user to be responsible and respectful of the copyright laws when using any Epson product. While some countries' laws permit limited copying or reuse of copyrighted material in certain circumstances, those circumstances may not be as broad as some people assume. Contact your legal advisor for any questions regarding copyright law.

Parent topic: [Copyright Notice](#)

Copyright Attribution

© 2023 Epson America, Inc.

9/23

CPD-63492

Parent topic: [Copyright Notice](#)