

PowerLite® Pro G6070W/G6170/G6270W/
G6470WU/G6570WU/G6770WU/G6870/
G6970WU

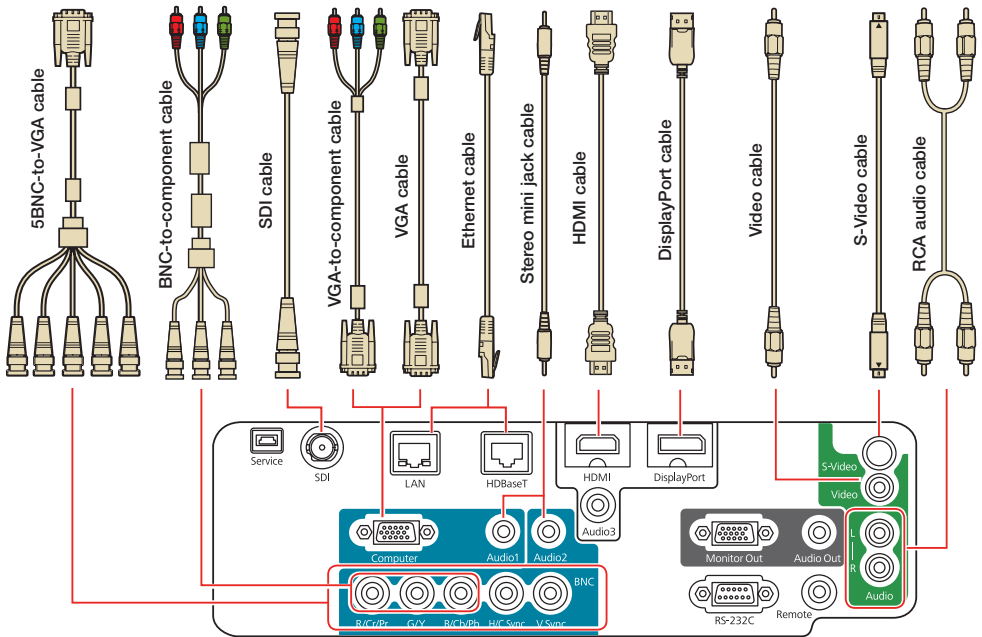

Quick Reference

This *Quick Reference* card gives brief instructions on connecting your PowerLite projector and using common features. For details, see the online *User's Guide*.



Note: SDI is available for the PowerLite Pro G6970WU only.

Turning the Projector On

1. Turn on your computer or image source.
2. Remove the lens cover.
3. Press the  power button (projector) or  **On** button (remote control). After the power light stays green, the projector is ready.

Note: If the Direct Power On function is enabled, you can turn the projector on without pressing the power button; just plug it in or flip the switch controlling the outlet to which the projector is connected. To turn on this feature, see the online *User's Guide*.

4. If your image does not appear, see “Switching Between Image Sources” or “Troubleshooting.”

Changing the Language of the Projector Menu

The default language of the projector's menu system is English, but you can change it as necessary.

1. Press the **Menu** button to access the projector's menu system.
2. Select **Extended > Language**.
3. Select your language.
4. When you're done, press **Menu** to exit.

Switching Between Image Sources

Press the **Search** button or one of the source buttons (remote control), or the **Source Search** button (projector).

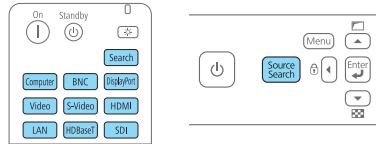

Selecting the Lens Type

Make sure the Lens Type setting is correct for the lens you are using.

1. Press the **Menu** button.
2. Select **Extended > Operation > Lens Type**.
3. Select the lens you are using.
4. When you're done, press **Menu** to exit.

Changing Screen Type

Set the Screen Type setting to the screen's aspect ratio.

1. Press the **Menu** button.
2. Select **Extended > Display > Screen > Screen Type**.
3. Select the screen's aspect ratio.

Note: The displayed image should match the screen's size and shape.

4. When you're done, press **Menu** to exit.

Note: After changing the screen type, you may need to change the aspect ratio of the projected image depending on the input signal. Press the **Aspect** button on the remote control to change the aspect ratio, if necessary.

Adjusting Image Position

1. Release the lens shift dial lock.

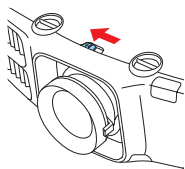

2. Turn the vertical and horizontal lens shift dials on the projector to adjust the position of the projected image.

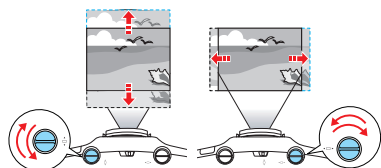

3. When you are done making adjustments, secure the lens shift dial lock.

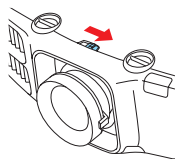

If the projector is on a table, you can level the image by turning any of the projector's adjustable feet.

Focusing and Zooming

Turn the focus ring to sharpen the image.

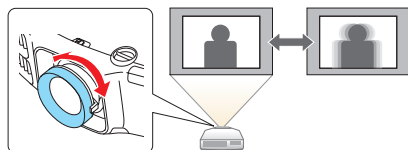

Turn the zoom ring to reduce/enlarge the image.

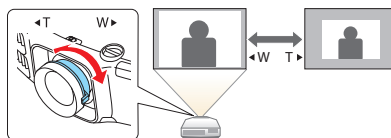



Correcting Image Shape

If your image is uneven on the sides, you can use the projector's distortion correction features such as H/V-Keystone and Quick Corner® to adjust the shape. See the *User's Guide*.

Making Other Image Adjustments

For help on using the projector's features to improve the image quality, see the online *User's Guide*. You can also view information on how to adjust the image color, position, and edges (Edge Blending) when projecting from multiple projectors to create one seamless widescreen image.

Turning the Projector Off

Press the  power (projector) or  **Standby** (remote control) button to turn the projector off. If you see a confirmation message, press the  power/**Standby** button again.

Note: If the Direct Power On function is enabled, you can unplug the projector or flip the switch controlling the outlet to which the projector is connected instead. To turn on this feature, see the online *User's Guide*.

With Epson's Instant Off® technology, you don't have to wait for the projector to cool down; just turn it off or unplug it when you're done.

Troubleshooting

If you see a blank screen or the message *No signal*

- Make sure the  power light on the projector is green and not flashing, and the lens cover is removed.
- Make sure the cables are connected correctly. See the online *User's Guide*.
- You may need to change the image source. See "Switching Between Image Sources." Also make sure the source device is turned on.

If the projector and the notebook don't display the same image

Windows®

Press the function key on your keyboard that lets you display on an external monitor. It may be labeled **CRT/LCD** or have an icon such as . You may have to hold down the **Fn** key while pressing it (such as **Fn + F7**). Wait a moment for the display to appear. You may need to press the keys again to display the image on both devices.

OS X

Open **System Preferences** and select **Displays**. Click the **Arrangement** tab and select the **Mirror Displays** checkbox.

Where to Get Help

Manuals

For more information about using the projector, click the icons on your desktop to access the online manuals (requires an Internet connection). If you don't have icon links to the manuals, you can install them from the projector CD or go to the Epson® website, as described below.

Internet support

Visit epson.com/support (U.S.) or epson.ca/support (Canada) to download utilities and documentation, get FAQs and troubleshooting advice, or e-mail Epson.

Speak to a support representative

To use the Epson® PrivateLine® Support service, call (800) 637-7661. This service is available for the duration of your warranty period. You may also speak with a projector support specialist by dialing (562) 276-4394 (U.S.) or (905) 709-3839 (Canada).

Support hours are 6 AM to 8 PM, Pacific Time, Monday through Friday and 7 AM to 4 PM, Pacific Time, Saturday.

Days and hours of support are subject to change without notice. Toll or long distance charges may apply.

Purchase supplies and accessories

You can purchase screens and other accessories from an Epson authorized reseller. To find the nearest reseller, call 800-GO-EPSON (800-463-7766). Or you can purchase online at epsonstore.com (U.S. sales) or epson.ca (Canadian sales).

Remote Control Map

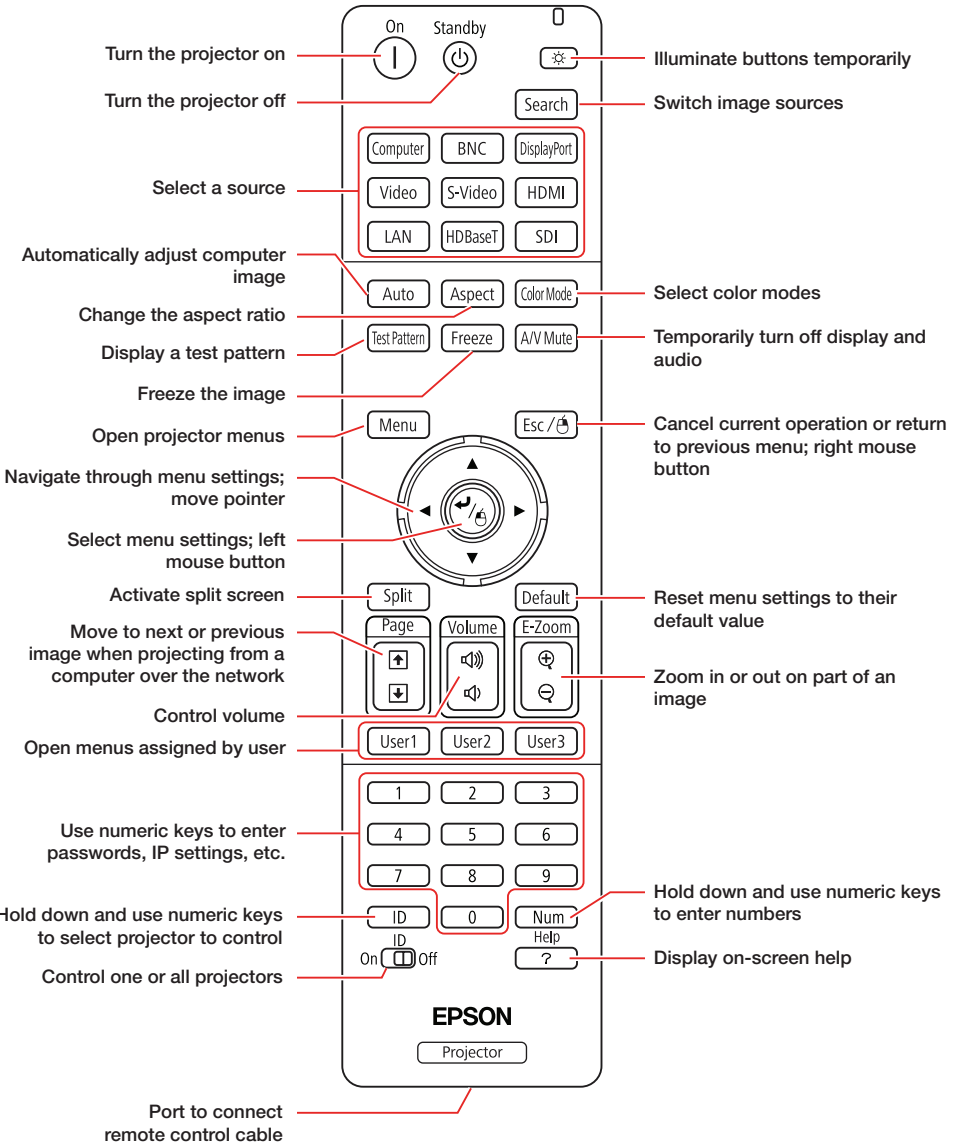

EPSON

Projector

Replacement Parts

Product	Part number
Replacement lamp (ELPLP76)	V13H010L76
Air filter (ELPAF43)	V13H134A43

You can purchase replacement parts from an Epson authorized reseller. See “Where to Get Help” inside this card for more information.

EPSON[®]
EXCEED YOUR VISION



EPSON, Instant Off, PowerLite, and Quick Corner are registered trademarks and EPSON Exceed Your Vision is a registered logomark of Seiko Epson Corporation. PrivateLine is a registered trademark of Epson America, Inc.

OS X is a trademark of Apple Inc., registered in the U.S. and other countries.

HDBaseT™ and the HDBaseT Alliance logo are trademarks of the HDBaseT Alliance.

General Notice: Other product names used herein are for identification purposes only and may be trademarks of their respective owners. Epson disclaims any and all rights in those marks.

This information is subject to change without notice.

© 2014 Epson America, Inc., 12/14

CPD-42338

Printed in XXXXXX



412873300